

Issued Date : 16. Feb. 2012

Issued No. : R1104-12010-011

Messrs :

RoHS Compliant

Temperature Compensated Crystal Oscillator
(TCXO)

KT1612A52000ECW18TAA

Technical Specification

Preliminary

KYOCERA KINSEKI Corporation

Revision History

Revision No.	Revision Date	Revision Content and reason	Prepared By	Approved By
1	16. Feb. 2012	The first edition	M.Ando	R.Sasagawa

TCXO KT1612A Parts Number**KT1612A52000ECW18TAA**

A : Product Specification Code
52000 : Nominal Frequency
E : Freq. Stability vs Temp +/-2.5ppm
C : Bottom Temperature Limit -30deg.C
W : Upper Temperature Limit +85deg.C
18 : Power Supply Voltage 1.8V
T : TCXO

TCXO KT1612A Electrical Characteristics*Ta= -30deg.C to +85deg.C, Vcc=1.8V, Load=10pF//10kohm*

Symbol	Item	Condition	Specification	Unit	Remarks
Vcc	Power Supply Voltage		1.8+/-0.1	V	
F0	Nominal Frequency		52.000000	MHz	
Topr	Operating Temperature		-30 to +85	deg.C	
Tstg	Storage Temperature		-40 to +85	deg.C	
Vout	Output Voltage	Load:10pF/10Kohm	0.8(min)	V	Ta=-30 to 85deg.C
Icc	Power Supply Current	Load:10pF/10Kohm	2.0(max)	mA	DC Bias
	Shutdown Current		10(max)	uA	
f0	Frequency Tolerance	Preset Frequency and shift after Twice Reflow	+/-2.0	ppm	Ta=25+/-2deg.C
df/F	Frequency Stability	vs Temp -30 to +85deg.C	+/-2.5	ppm	ref:Ta=25+/-2deg.C
		vs Load 10pF+/-10% 10Kohm+/-10%	+/-0.2	ppm	
		vs Vcc=1.8 +/-0.1V	+/-0.1	ppm	
dfag	Frequency Aging Rate	Ta=25+/-2deg.C	+/-1.0	ppm/Y	One Year
---	Harmonics	3rd	-8(max)	dBc	
---	SSB Carrier Noise	@1kHz offset	-125(max)	dBc/Hz	Ta=25+/-2deg.C
		@10kHz offset	-141(max)	dBc/Hz	
		@100kHz offset	-150(max)	dBc/Hz	
		@1MHz offset	-153(max)	dBc/Hz	
---	Enable/Disable	Enable-Active Hi	80%Vcc(min)	V	
		Disable-Active Low	20%Vcc(max)		

KT1612A Dimension, Pin Connections & Recommended Land Pattern

Note : This dimension is subject to change before mass production because this product is under development.

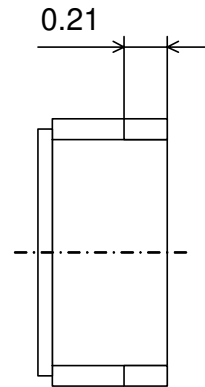
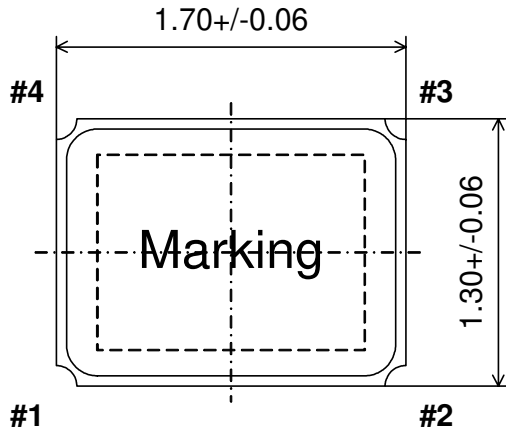

Unit : (mm)

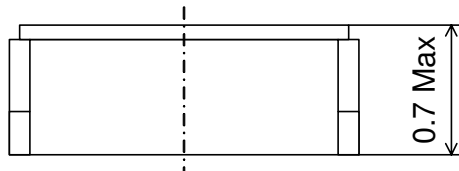

Note1
Co-planarity : 60um Max

Note2
Electrode : Mo + Ni 1.5 to 8.89um
+ Au 0.3 to 1.0um

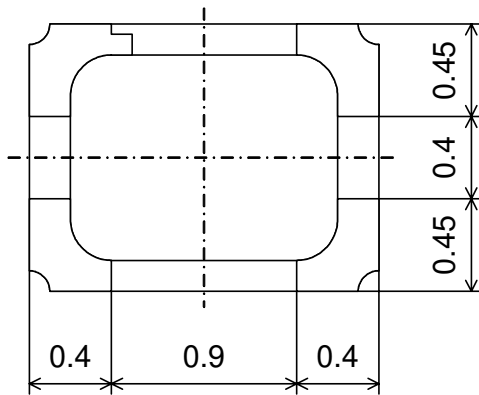

Pin No.	Pin Layout
#1	Enable / Disable
#2	GND
#3	Output
#4	Vcc

Land Pattern (Reference)

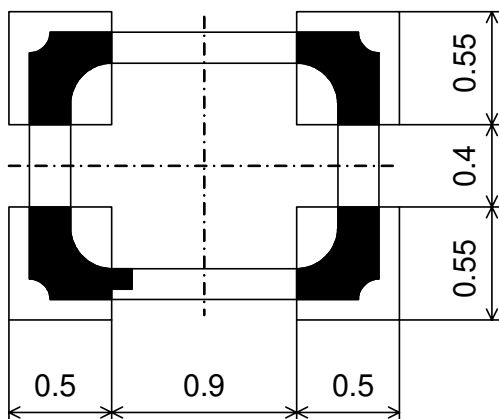

KT1612A Recommended Circuit

※1

Bypass Capacitor and DC-Blocking Capacitor do not build in this Parts. So, Bypass Capacitor and DC-Blocking Capacitor are attached outside and please use it. And these Capacitors should be placed as close as possible to the pin (No.3 and No.4). ※2

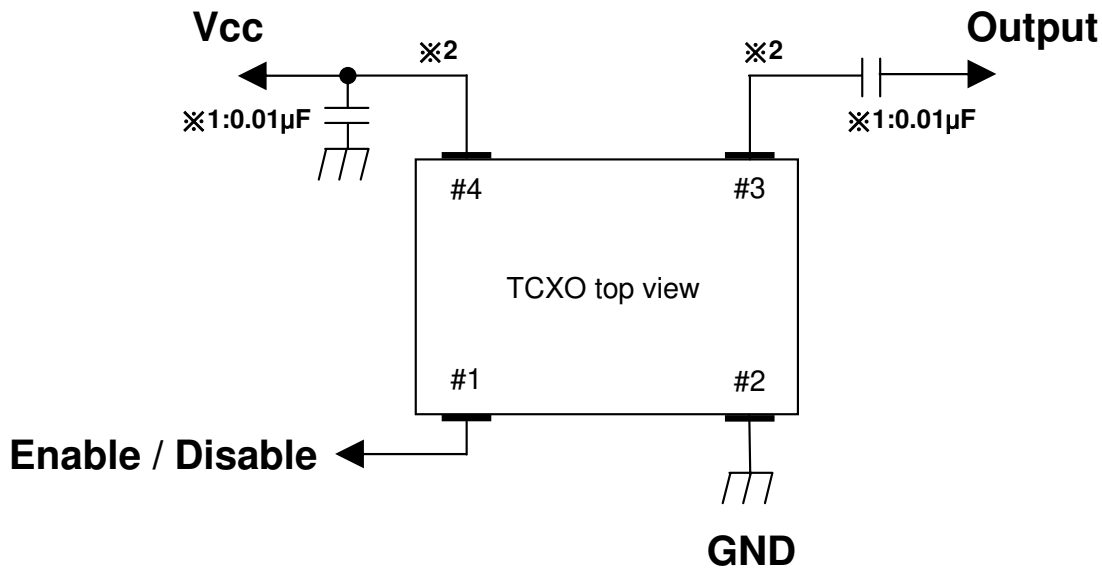

KT1612A Recommended Reflow Soldering Condition (Lead Free Version)

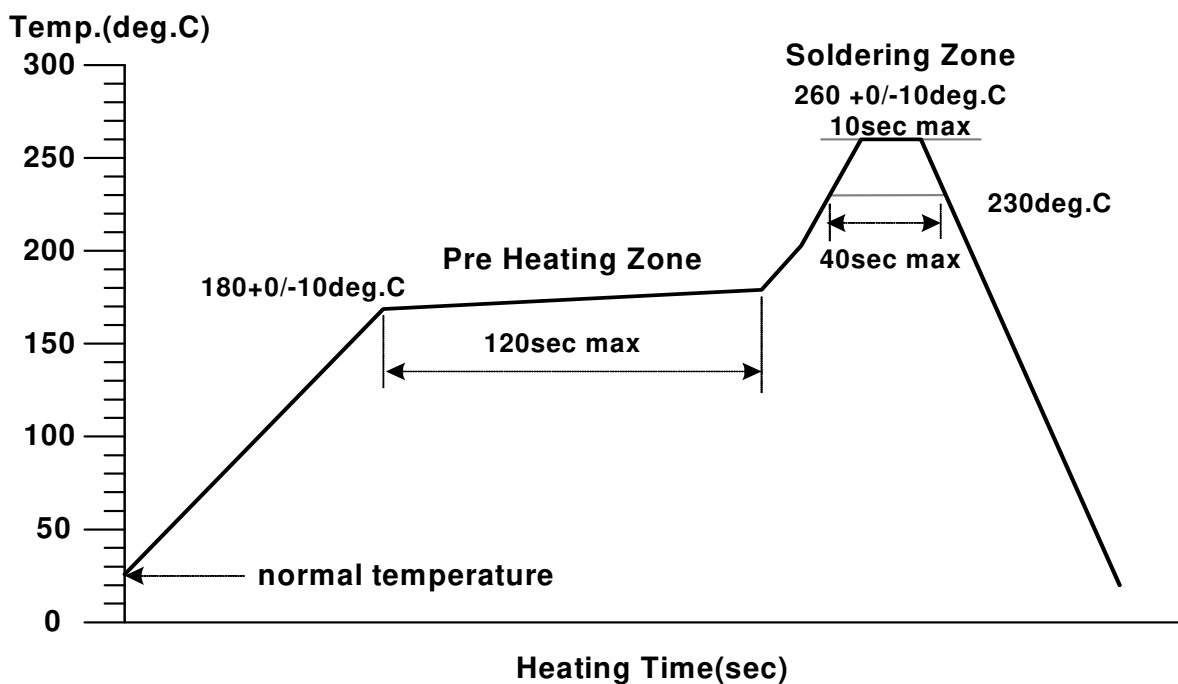

KT1612A Caution to handle

- 1. Touch the solder iron at 260+/-5deg.C onto the leads for 10+/-2sec max or touch the solder at 350+/-5deg.C onto the leads for 3+/-0.5sec max.**
- 2. In the customer's reflow process, if it will remain some mechanical stress at the soldering terminals, also make some cracks on the soldering termination. Some cracks will cause open or short circuit and cause of thermal increasing or smoking. Don't make any excess mechanical stress to soldering points.**
- 3. In case of giving a heavy shock to the products, it make an open or short circuit and cause of thermal increasing or smoking. To avoid heavy shock impact applying to products is strictly required.**
- 4. Moisture Sensitivity Level
MSL=1**