



### Main

Range of Product	Modicon M251
Product or Component Type	Logic controller
[Us] rated supply voltage	24 V DC

### Complementary

Maximum number of I/O expansion module	7 (local I/O-Architecture) 14 (remote I/O-Architecture)
Supply voltage limits	20.4...28.8 V
Inrush current	50 A
Power consumption in W	32.6...40.4 W with max number of I/O expansion module)
Memory capacity	8 MB program 64 MB system memory RAM
Data backed up	128 MB built-in flash memory backup of user programs
Data storage equipment	<= 16 GB SD card optional)
Battery type	BR2032 lithium non-rechargeable 4 year(s)
Backup time	2 years 77 °F (25 °C)
Execution time for 1 KInstruction	0.3 Ms event and periodic task 0.7 ms other instruction
Execution time per instruction	0.022 µs
Application structure	3 cyclic master tasks + 1 freewheeling task 8 event tasks 4 cyclic master tasks 8 external event tasks
Realtime clock	With
Clock drift	<= 60 s/month 77 °F (25 °C)
Integrated connection type	USB port mini B USB 2.0 Non isolated serial link serial RJ45 RS232/RS485 Dual-port Ethernet RJ45 CANopen J1939 SUB-D 9
Supply	Serial)serial link supply 5 V, <200 mA
Transmission rate	1.2...115.2 kbit/s (115.2 kbit/s by default) 49.21 ft (15 m) RS485 1.2...115.2 kbit/s (115.2 kbit/s by default) 9.84 ft (3 m) RS232 480 Mbit/s 9.84 ft (3 m) USB
Communication port protocol	USB port USB - SoMachine-Network Non isolated serial link Modbus master/slave - RTU/ASCII or SoMachine-Network
Port Ethernet	Ethernet 10BASE-T/100BASE-TX - 2 copper cable
Web services	Web server

The information provided in this documentation contains general descriptions and/or technical characteristics of the performance of the products contained herein. This documentation is not intended as a substitute for and is not to be used for determining suitability or reliability of these products for specific user applications. It is the duty of any such user or integrator to perform the appropriate and complete risk analysis, evaluation and testing of the products with respect to the relevant specific application or use thereof. Neither Schneider Electric Industries SAS nor any of its affiliates or subsidiaries shall be responsible or liable for misuse of the information contained herein.

Communication service	DHCP client Downloading Ethernet/IP slave device IEC VAR ACCESS Modbus TCP client Modbus TCP server Modbus TCP slave device Monitoring NGVL Programming Updating firmware SMS notifications FTP client/server SNMP client/server SQL client Send and receive email from the controller based on TCP/UDP library Web server (WebVisu & XWeb system) OPC UA server DNS client
Maximum number of connections	8 Modbus server 8 Modbus client 16 Ethernet/IP target 4 FTP server 10 web server 8 SoMachine protocol
CANopen feature profile	DR 303-1 DS 301 V4.02
Number of slave	63 CANopen
Local signalling	For PWR 1 LED (green) For RUN 1 LED (green) For module error (ERR) 1 LED (red) For I/O error (I/O) 1 LED (red) For SD card access (SD) 1 LED (green) For BAT 1 LED (red) For Ethernet port activity 1 LED (green) For SL 1 LED (green) For bus fault on TM4 (TM4) 1 LED (red) For CANopen run 1 LED (green) For CANopen error 1 LED (green)
Electrical connection	Removable screw terminal block power supply pitch 5.08 mm)
Insulation	Non-insulated between supply and internal logic Between supply and ground 500 V AC
Marking	CE
Surge withstand	1 kV shielded cable common mode EN/IEC 61000-4-5 1 kV power lines common mode EN/IEC 61000-4-5 0.5 kV power lines differential mode EN/IEC 61000-4-5
Mounting support	Top hat type TH35-15 rail IEC 60715 Top hat type TH35-7.5 rail IEC 60715 Plate or panel with fixing kit
Height	3.54 in (90 mm)
Depth	3.74 in (95 mm)
Width	2.13 in (54 mm)
Net Weight	0.49 lb(US) (0.22 kg)

## Environment

Standards	ANSI/ISA 12-12-01 CSA C22.2 No 142 CSA C22.2 No 213 EN/IEC 61131-2:2007 Marine specification (LR, ABS, DNV, GL) UL 1604 UL 508
Product Certifications	CULus CSA
Resistance to electrostatic discharge	8 kV in air EN/IEC 61000-4-2 4 kV on contact EN/IEC 61000-4-2
Resistance to electromagnetic fields	9.14 V/m (10 V/m) 80 MHz...1 GHz EN/IEC 61000-4-3 2.74 V/m (3 V/m) 1.4 GHz...2 GHz EN/IEC 61000-4-3 0.91 V/m (1 V/m) 2 GHz...3 GHz EN/IEC 61000-4-3
Resistance to fast transients	2 kV EN/IEC 61000-4-4 power lines) 1 kV EN/IEC 61000-4-4 Ethernet line) 1 kV EN/IEC 61000-4-4 serial link)
Resistance to conducted disturbances	10 V 0.15...80 MHz EN/IEC 61000-4-6 3 V 0.1...80 MHz Marine specification (LR, ABS, DNV, GL) 10 V spot frequency (2, 3, 4, 6.2, 8.2, 12.6, 16.5, 18.8, 22, 25 MHz) Marine specification (LR, ABS, DNV, GL)
Electromagnetic emission	Conducted emissions 120...69 dB $\mu$ V/m QP power lines)10...150 kHz EN/IEC 55011 Conducted emissions 63 dB $\mu$ V/m QP power lines)1.5...30 MHz EN/IEC 55011 Radiated emissions 40 dB $\mu$ V/m QP class A 10 m)30...230 MHz EN/IEC 55011 Conducted emissions 79...63 dB $\mu$ V/m QP power lines)150...1500 kHz EN/IEC 55011 Radiated emissions 47 dB $\mu$ V/m QP class A 10 m)230...1000 MHz EN/IEC 55011
Immunity to microbreaks	10 ms
Ambient air temperature for operation	14...95 °F (-10...35 °C) vertical installation) 14...131 °F (-10...55 °C) horizontal installation)
Ambient Air Temperature for Storage	-13...158 °F (-25...70 °C)
Relative humidity	10...95 %, without condensation in operation) 10...95 %, without condensation in storage)
IP degree of protection	IP20 with protective cover in place
Pollution degree	2
Operating altitude	0...6561.68 ft (0...2000 m)
Storage altitude	0.00...9842.52 ft (0...3000 m)
Vibration resistance	3.5 mm 5...8.4 Hz symmetrical rail 3 gn 8.4...150 Hz symmetrical rail 3.5 mm 5...8.4 Hz panel mounting 3 gn 8.4...150 Hz panel mounting
Shock resistance	15 gn 11 ms

## Ordering and shipping details

Category	22533 - M2XX PLC & ACCESSORIES
Discount Schedule	MSX
GTIN	3606480648861
Nbr. of units in pkg.	1
Package weight(Lbs)	13.40 oz (380 g)
Returnability	Yes
Country of origin	ID

## Packing Units

Unit Type of Package 1	PCE
Package 1 Height	4.19 in (10.632 cm)
Package 1 width	4.67 in (11.868 cm)
Package 1 Length	6.58 in (16.721 cm)
Unit Type of Package 2	S03
Number of Units in Package 2	10
Package 2 Weight	9.83 lb(US) (4.461 kg)

Package 2 Height	11.81 in (30 cm)
Package 2 width	11.81 in (30 cm)
Package 2 Length	15.75 in (40 cm)

## Offer Sustainability

Sustainable offer status	Green Premium product
California proposition 65	WARNING: This product can expose you to chemicals including: Lead and lead compounds, which is known to the State of California to cause cancer and birth defects or other reproductive harm. For more information go to <a href="http://www.P65Warnings.ca.gov">www.P65Warnings.ca.gov</a>
REACH Regulation	<a href="#">REACH Declaration</a>
EU RoHS Directive	Pro-active compliance (Product out of EU RoHS legal scope) <a href="#">EU RoHS Declaration</a>
Mercury free	Yes
RoHS exemption information	<a href="#">Yes</a>
China RoHS Regulation	<a href="#">China RoHS Declaration</a>
Environmental Disclosure	<a href="#">Product Environmental Profile</a>
Circularity Profile	<a href="#">End Of Life Information</a>
WEEE	The product must be disposed on European Union markets following specific waste collection and never end up in rubbish bins.
PVC free	Yes

Dimensions

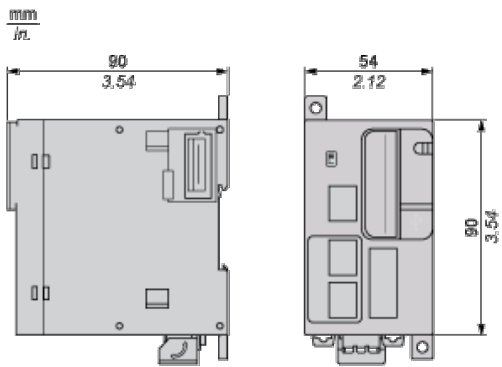

Clearance

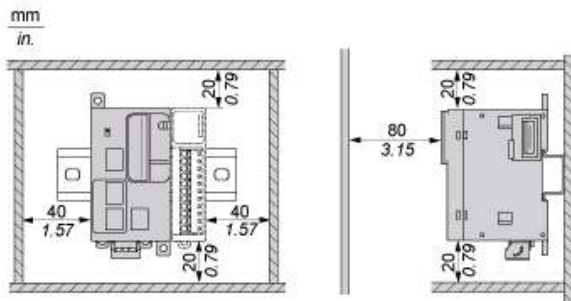

Mounting Position

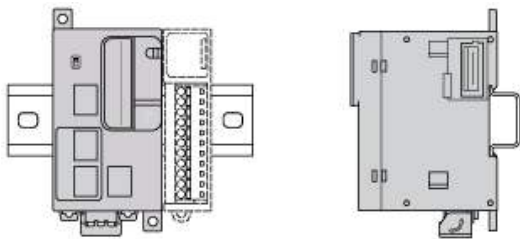

NOTE: Keep adequate spacing for proper ventilation and to maintain an ambient temperature between -10°C (14°F) and 55°C (131°F).

Acceptable Mounting

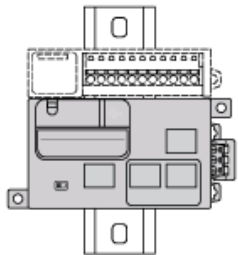

NOTE: Expansion modules must be mounted above the controller.

Incorrect Mounting

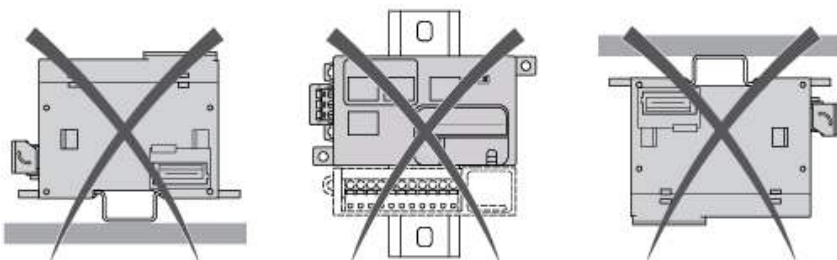

Direct Mounting on a Panel Surface

M4 x 6/8 mm  
0.24/0.31 in.

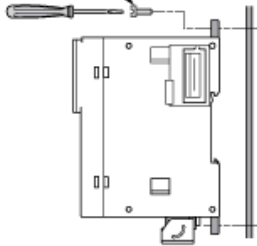

mm  
in.

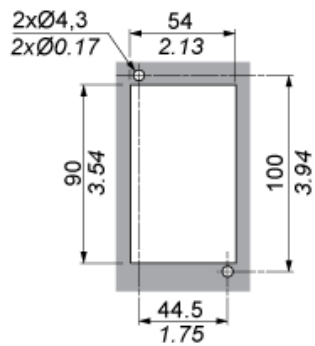

USB Connection to a PC



Ethernet Connection to a PC



CANopen

Wiring

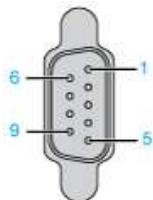

Pin	Signal	Description
1	–	Reserved
2	CAN_L	CAN_L bus line
3	CAN_GND	CAN ground
4	–	Reserved
5	(CAN_SHLD)	Optional CAN shield
6	GND	Ground
7	CAN_H	CAN_H bus line
8	–	Reserved
9	(CAN_V+)	Optional CAN external positive supply