

REFERENCE COMMERCIALE / PART NUMBER : **CMA-USB RA50**

PRESENTATION

Raccord CMA-USB RA50, nécessitant un montage sur une fiche USB type C sur câble (non fourni). Il se monte sur toutes les fiches, prolongateurs et traversées de panneau de la famille BERNIER CMA-USB. Une gaine thermorétractable fournie assure l'étanchéité arrière du raccord. Des compensateurs sont fournis pour adapter la longueur du boîtier du cordon USB à la longueur du manchon USB.

MATIERE ET FINITION

- Corps : alliage aluminium traité noir,
- Manchon USB : TPU,
- Joint torique : élastomère.
- Gaine thermorétractable : polyoléfine avec adhésif

Masse : 23g max
Couple de serrage : 6N.m

INTRODUCTION





Backshell CMA-USB RA50, requiring assembly with USB-C Plug on cable (not supplied). It can mate on all plugs, cable extensions and panel through BERNIER CMA-USB line. A heat shrink tubing provided ensures the rear sealing of the backshell. Compensators are provided to adapt the length of the USB cable housing to the length of the USB sleeve.

MATERIALS AND FINISH

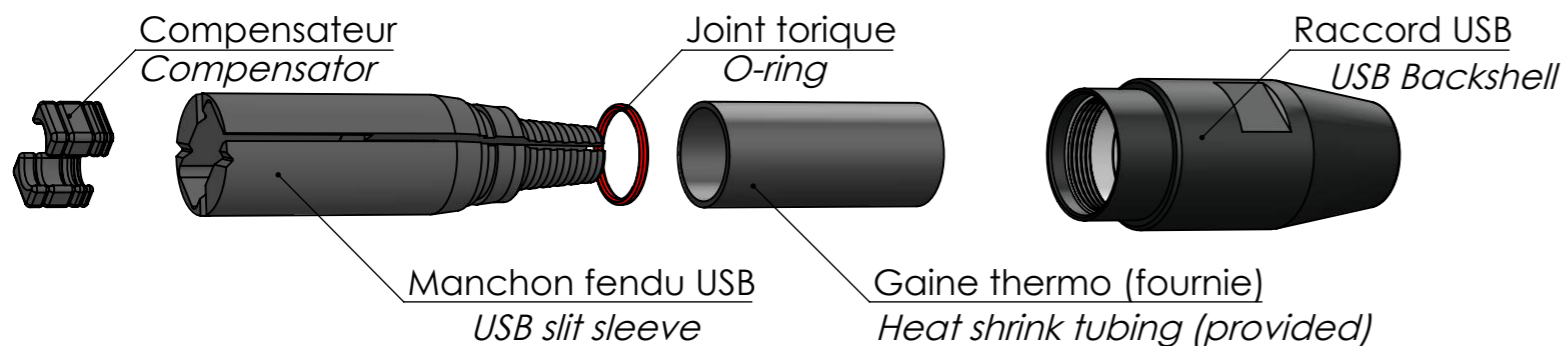
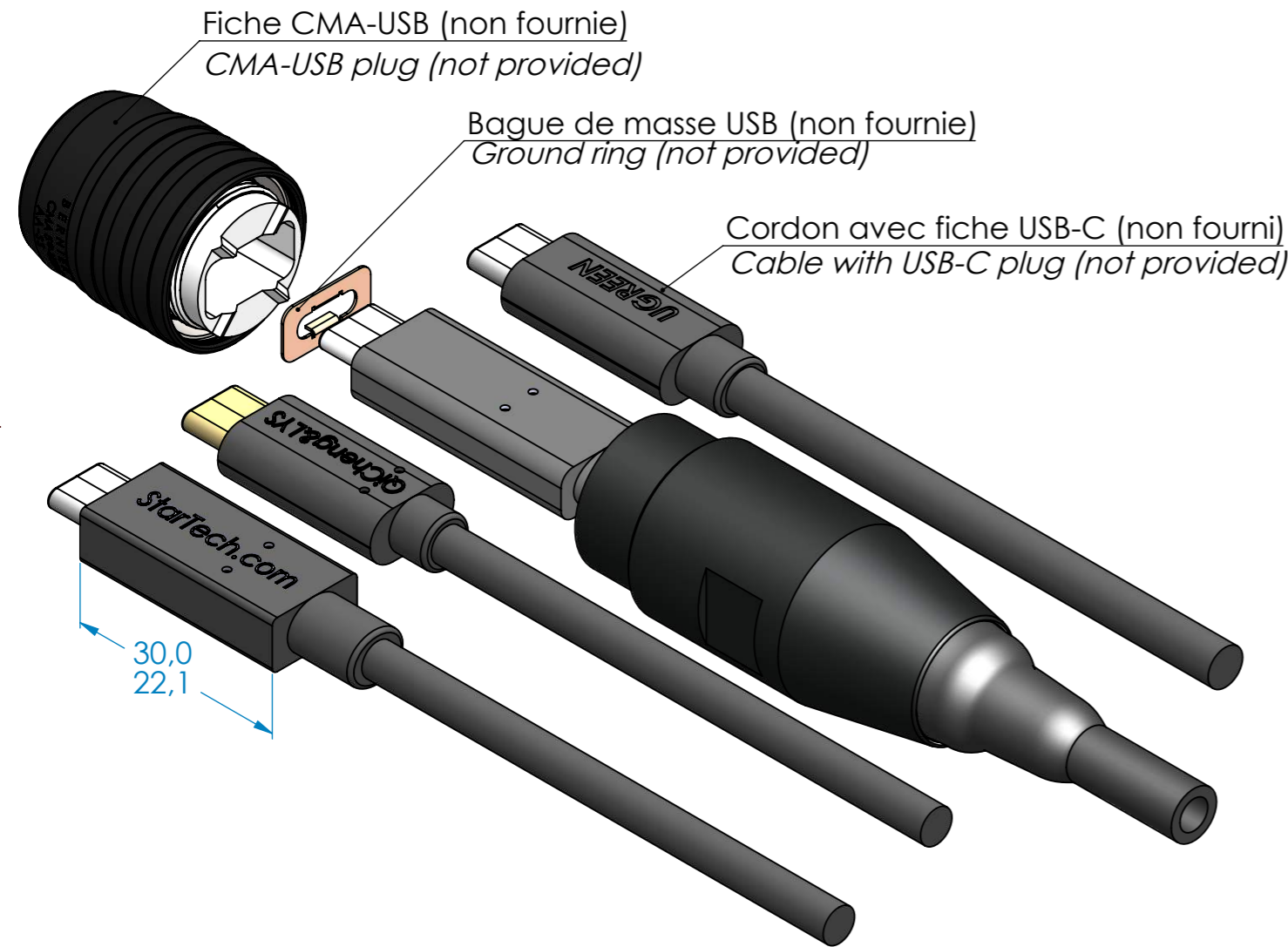
- Shell and tightening ring : aluminium alloy with black plating,
- Sleeve USB : TPU
- O-ring : elastomer.
- Heat shrink tubing: Polyolefin Adhesive .

Weight : 23g max
Locking torque : 6N.m



16/06/2020		-			DMT	JGC			
Notice of changes Avis d'évolution	DATE	REVISION INDICE	CHANGE DESCRIPTION MODIFICATION			DRAW BY DESS. PAR	CHECKED BY VERIF. PAR	APPROVED BY APPR. PAR	
PRODUCT SPEC. SPECIF PRODUIT	PACKAGING SPEC. SPECIF EMBALLAGE	APPLICATION SPEC. SPECIF APPLICATION	THIS DRAWING AND ALL OTHER INFORMATION CONTAINED THERE IN IS PROPRIETARY OF BERNIER. This drawing may not be copied, reproduced or disclosed to any third party without the expressed written permission of BERNIER. © BERNIER November 2014		LES INFORMATIONS CONTENUES DANS CE PLAN SONT LA PROPRIETE DE BERNIER. Ce plan ne peut être copié, reproduit ou transmis sans l'autorisation expresse et écrite de BERNIER © BERNIER Novembre 2014				
TOLERANCES ±0.2 ±2°		MATERIAL MATIERE	SURFACE FINISH ETAT DE SURFACE				 CAD SYSTEME SOLIDWORKS		
CONTREPARTIE N° CONTREPARTIE N°		COLOR COULEUR					 DIMENSIONS IN MILLIMETER DIMENSIONS EN MILLIMETRE		A3
DO NOT SCALE DRAWING NE PAS PRENDRE DE COTES		TOOL NO OUTIL N°				 REFERENCE PLAN		SHEET Feuille 1 SUR 1	
DRAW BY DESS. PAR	DATE	NAME NOM	TITLE DESIGNATION		DRAWING NUMBER REFERENCE PLAN		SHEET		
CHECKED BY VERIF. PAR	16/06/2020	DMT	SERIE CMA-USB RACCORD POUR CORDON FICHE USB-C USB-C PLUG CABLE BACKSHELL		CMA-USB RA50 NOTICE TECHNIQUE DATA SHEET		NT681		
APPROVED BY APPR. PAR			ESR NO NUMERO ESR		FILE NAME NOM DU FICHER		NT681		
							EHELLE 2:1		