

# Multimec™ 3C

High performance tactile switches •  
robust



## DISTINCTIVE FEATURES

10 x 10 mm; h=6.4 mm

Excellent for over-mold and under overlay



## ENVIRONMENTAL SPECIFICATIONS

- Sealing : IP67 according to IEC 60529
- Working and storage temperature : -40 °C/+160 °C (-40 °F to +320 °F)
- Soldering :
  - through-hole : IEC 60068-2-20 8
  - surface mount : JEDEC J-STD-020E



## ELECTRICAL SPECIFICATIONS

- Recommended load :
  - Gold contacts : 0.5µ-50 mA 24 VDC
  - Silver contacts : 0.5-50 mA 24 VDC
- Contact resistance : <30 mΩ - typically 10 mΩ
- Insulation resistance : >10 MΩ
- Contact bounce : <2 mS - typically 0.5 mS



## MECHANICAL SPECIFICATIONS

- Standard actuation force : 3.5 N
- Max. actuation force : 100 N for 10 sec
- Travel : 1 mm
- Lifetime : >10,000,000 cycles

The company reserves the right to change specifications without notice.



## MATERIALS

- Housing : PPS UL94V0
- Actuator : PPS UL94V0
- Sealing : Silicone rubber
- Contacts spring : Stainless steel
  - Silver : +3 µAg
  - Gold : +1 µAu
- Fixed contacts :
  - Silver : SnCu + 2 µNI + 3 µAg
  - Gold : SnCu + 2 µNI + 1 µAu
- Terminals : SnCu + 2 µNI + 3 µSn100

All tolerance if not otherwise specified ±0.2 mm.

# Multimec™ 3C

High performance tactile switches • robust

## 3C - SMD

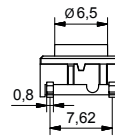
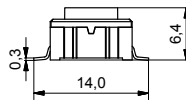
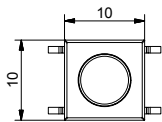

## 3C - TH

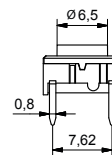
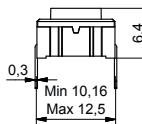
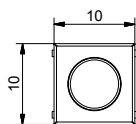

## 3C - TH RAS

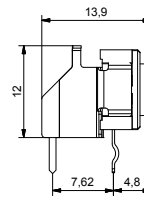
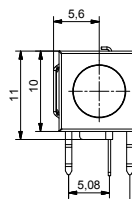
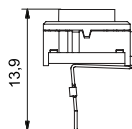

## PCB LAYOUT & CIRCUIT DIAGRAM

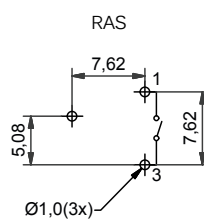
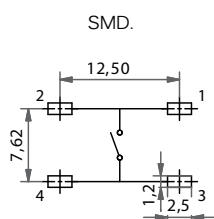
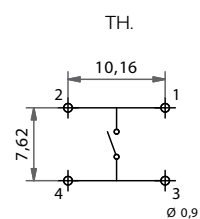



## BUILD YOUR PART NUMBER

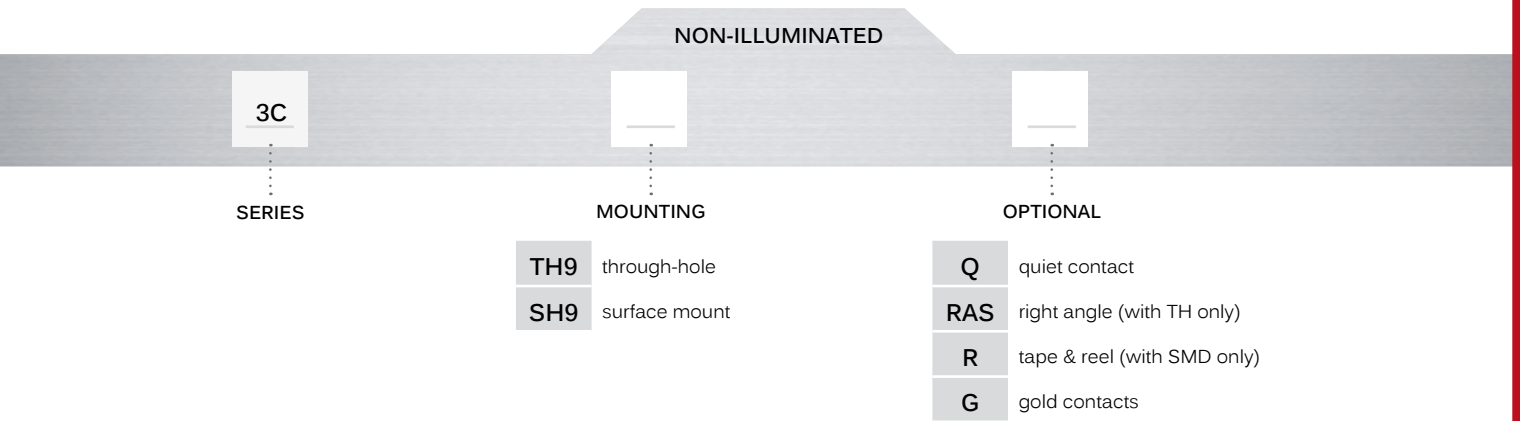

# Multimec™ 3C

High performance tactile switches • robust



## TAPE & REEL

Tape and reel is available for the parts listed and has the following specifications

- Reel diameter: Ø330 mm
- Tape width: 24 mm
- Pitch: see list
- Tape and reel material: antistatic or better
- Quantity per reel: see list

PART NO.	ORDERING CODE	PITCH	QUANTITY PER REEL
3CSH9	3CSH9R	16	500



## RECOMMENDED OPERATING CONDITIONS

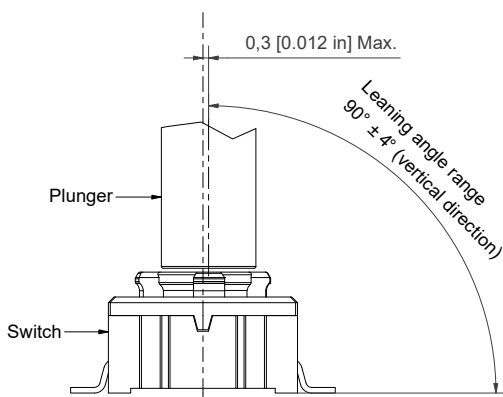

For the optimal performance of the switch use the recommended operating conditions.



## MOUNTING

MOUNTING TOOLS FOR MULTIMEC™ THROUGH-HOLE SWITCHES

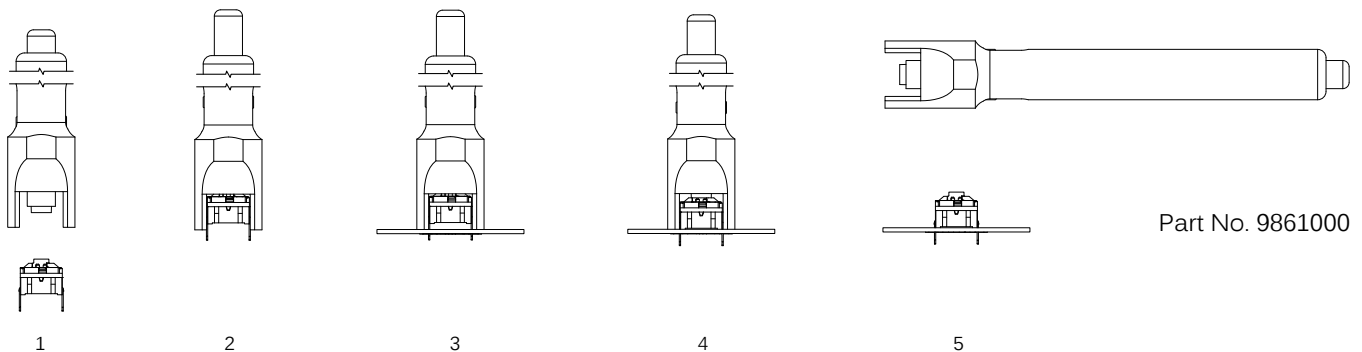

Part No. 9861000



## OPERATING FORCE

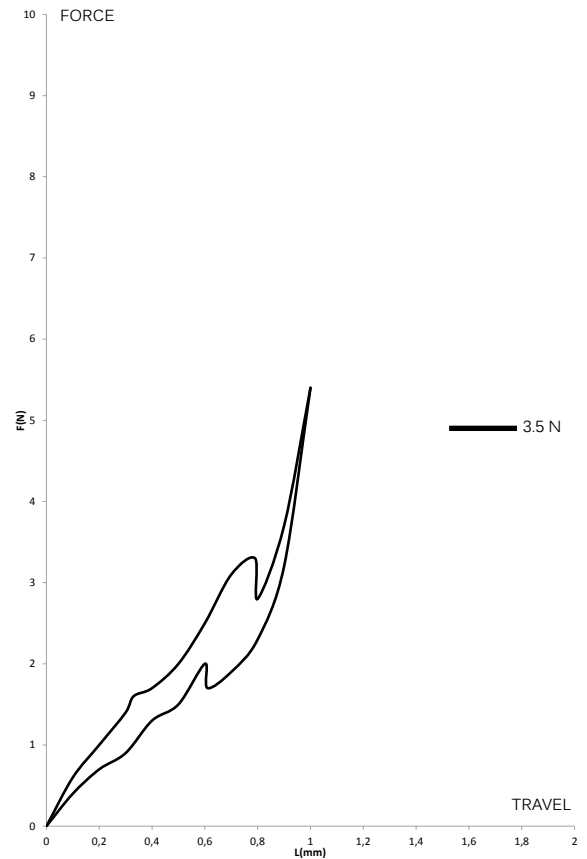

High performance tactile switches • robust



## MOUNTING (CONTINUED)

### SPACE REQUIREMENT - MATRIX MOUNTING

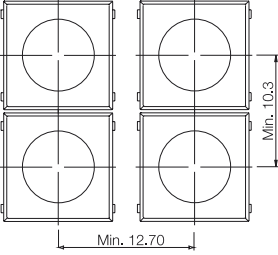

Through-hole (TH)

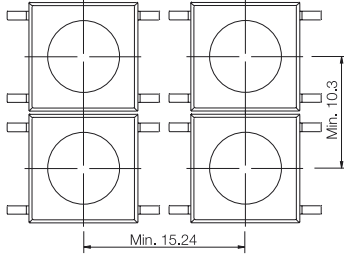

Surface mount (SMD)

# Multimec™ 3C

High performance tactile switches •  
robust



## USAGE GUIDELINES

### HOW TO GET THE BEST RESULTS WITH MEC SWITCHES ?

These guidelines are offered to users of MEC Switches as an aid to ensure successful and reliable switch operation. Please see the technical specifications for details on operating and storage temperatures and soldering guidelines to make sure you select the best switch for your application. When reflow soldering is taking place, MEC strongly recommend that the temperature profile is analyzed and compared with the temperature rating of the switch. It is also important to monitor the accumulated heat buildup from both the pre-heat zones and the solder zone.

### MOUNTING AND DISMOUNTING

If switches are to be mounted in rows it is essential that the recommendations regarding spacing are followed. PC board thickness should be  $1.4 \pm 0.2$  mm and terminal hole diameter should be 0.9 mm.

A mounting tool is available for through hole multimec™ 3 series switches.

### SOLDERING AND CLEANING MULTIMEC™ 3 SERIES

Multimec™ 3 series switches are fully sealed to IP67 specifications to prevent solder flux and aqueous based cleaning solutions from entering the switch and contaminating the contacts. The switches can be placed on the PC board with other components and reflow soldered. Multimec™ 3 series offers a high level of sealing, however, with aqueous solvent solutions care must be taken to avoid the worst case situation with water jets, complete immersion into a liquid with a temperature below the board or surface tension reducing additives.

Recommended cleaning methods are demineralized water. Any surface tension reducing agents, such as soap, must not be used as they risk causing a potential leakage of the switch.

### SOLDERING - THROUGH HOLE VERSIONS

**Hand soldering:** max. 350 °C for max. 3 sec

**Wave soldering:** heat built up in the switch during pre-heating and soldering must not exceed the maximum operating temperature of the switch. Peak temperature must not exceed 260 °C, and soldering time is max 10 sec. (IEC 60068-2-20 8).

### SOLDERING - SURFACE MOUNT VERSIONS

For all methods - infrared, convection and vapor phase. The upper limit 240 °C/40 sec must be observed. The soldering temperature profile must have moderate temperature gradients. (JEDEC J-STD-020E)

### ROHS COMPLIANCE

As of 1 July 2006 MEC has completed the conversion to RoHS compliance. For more info please see our homepage [www.apem.com](http://www.apem.com)

### TEMPERATURE LIMITS:

Switch	160 °C
--------	--------

### PACKAGING

Multimec™ 3 series switches are packed in rigid tubes of 50 pieces each.

A box contains 1.000 pcs.

The surface mount versions of multimec™ 3C series switches can also be delivered on tape/reel. Each reel contains 500 pcs.

Right angle switches are packed into trays. Each tray contains 100 pcs.