

Bridgelux® Vesta® Flex Dual Channel 30W Driver

Product Data Sheet DS 451



Vesta Flex Platform

The Bridgelux Vesta Flex Dual Channel Driver and Control Module family is a bundled system, guaranteed to work together out of the box, that enables seamless control of the Bridgelux Vesta Series Tunable White Arrays and Modules. The Driver's high resolution dimming and tuning algorithm provides for smooth and flicker-free CCT tuning, dimming to 0.1%, and dim-to-off. These specification grade drivers and control modules are separate devices which, when connected via an ethernet cable, form a smart and flexible lighting control system. The platform offers a number of driver and control module options to choose from, enabling application flexibility and interoperability with third party systems. These different control modules support wired control protocols such as DALI-2 DT8 and 0-10V as well as wireless control protocols with WiFi and Bluetooth mesh. These platforms come with ready-built iOS and Android apps and web portals which provide for commissioning, light management, and services designed to expand the capability of modern lighting systems. Vesta Flex is a future-ready solution, designed to quickly adapt to new control systems without requiring luminaire recertification.

Vesta Flex Platform Overview

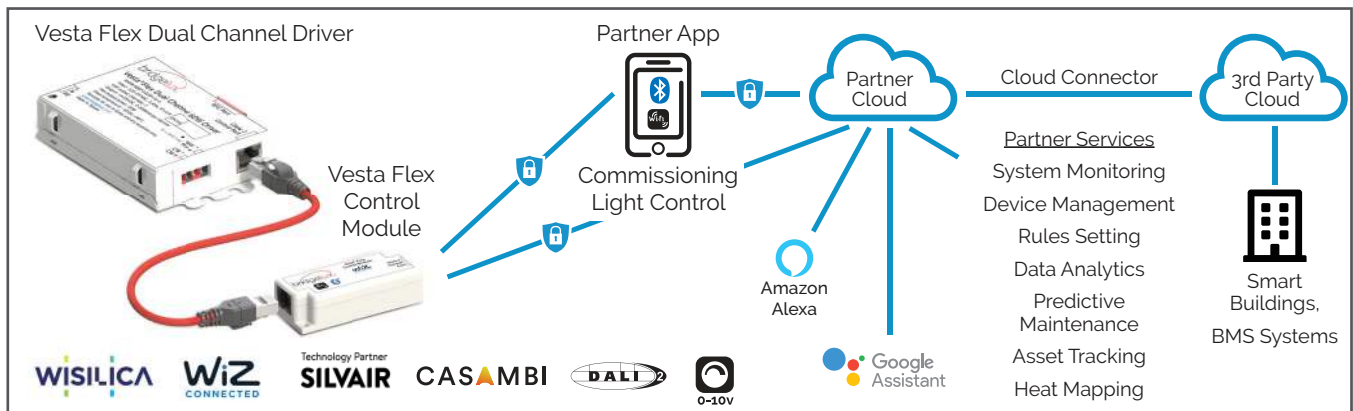

Vesta Flex Dual Channel Driver Features and Benefits

- 120-277VAC/50-60Hz universal input voltage
- Side and bottom feed poke-in connector terminals
- Strain relief and stud mounting options
- Smooth, flicker free dimming and CCT tuning
- Each channel is dimmable to 0.1%, dim to dark
- NFC port for programming multiple driver settings
- Linear, square and logarithmic intensity dimming profiles
- RJ45 control port reliably connects with all Vesta Flex Control Modules
- Inter-operable with a large ecosystem of BLE mesh, Wi-Fi, DALI-2 DT8 and 0-10V devices and controls

For more information on the Vesta Flex Dual Channel Driver and Control Module options, please visit bridgelux.com

Product Feature Map

Bridgelux Vesta Flex Dual Channel 30W Driver provides two dynamic constant current outputs for dual channel CCT tunable LED modules and arrays. This Driver interoperates with industry standard lighting control systems and allows for simple integration of Vesta Flex Tunable White Arrays and Linear modules. Please visit www.bridgelux.com for more information.

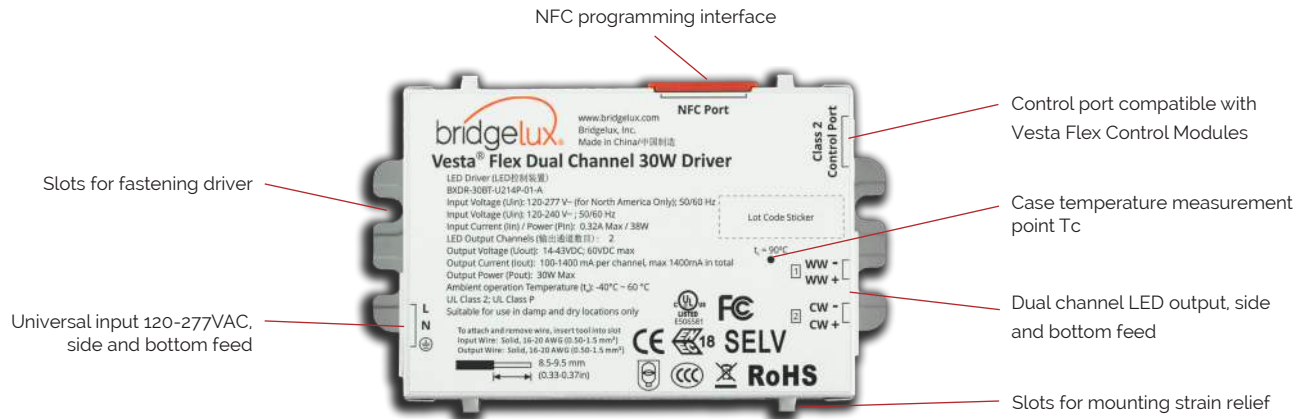

Product Nomenclature

The part number designation for Bridgelux Vesta Flex Dual Channel 30W Driver is explained as follows:

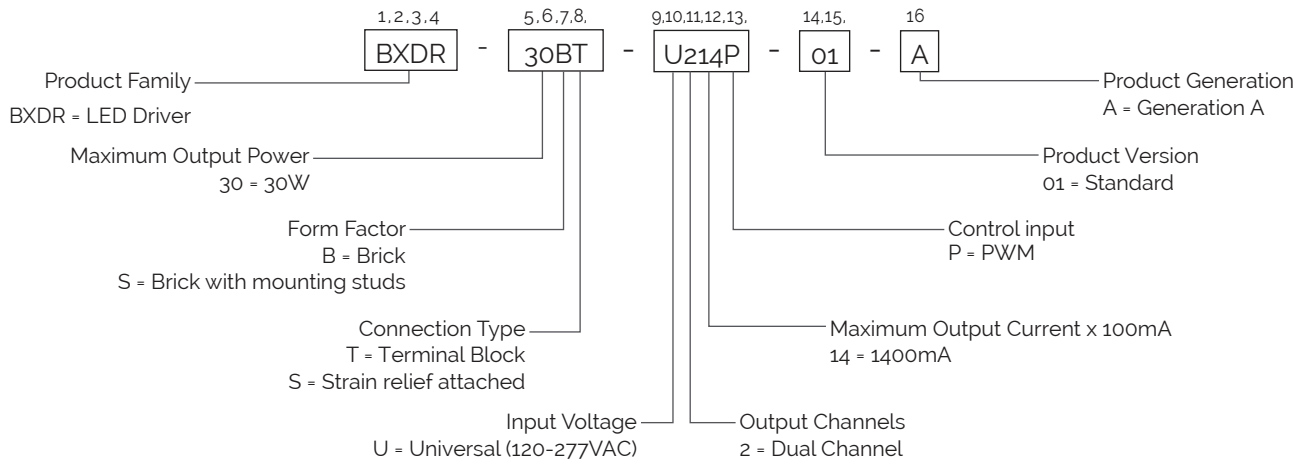

Table 1: Product Selection Guide

Part Number	Configuration
BXDR-30BT-U214P-01-A	Brick
BXDR-30ST-U214P-01-A	Brick with mounting studs
BXDR-30BS-U214P-01-A	Brick with strain relief attached



Electrical Characteristics

Table 2: Electrical Characteristics

Parameter	Specification
Input Voltage	120VAC to 277VAC $\pm 10\%$
Input Power	35W (max)
Input Current	0.3A (max)
Inrush Current	Beneath NEMA 410-2011 limit
Surge Protection	6kV per EN 61547: 2009 (IEC 61000-4-5: 2006)
ESD Rating	Class 3B, HBM
Output Power	30W (max)
Output Voltage per Channel	14 - 43V DC
Output Current per Channel ¹	1400mA (max)
Output Current from both Channels combined ¹	1400mA (max)
Output Current Tolerance	$\pm 1\%$ at output loads ranging from 10% - 100% of max load
Output Current Variation between Channels ²	$\pm 5\%$
Startup Time	<0.5s
Output Ripple	<2% at 120VAC
Minimum Dimming Level	0.1%; dim to off
Efficiency ³	83% full load at 120-277VAC
Power Factor ³	>0.9 at 120 to 277VAC (typical, at max load)
Total Harmonic Distortion (THD) ³	<20% at line voltages ranging from 120VAC to 277VAC and loads ranging from 15W to 30W
Standby Power ⁴	<0.25W at 120VAC, <0.35W at 220VAC/240VAC and <0.40W at 277VAC
Short Circuit Protection	A short between output terminals results in no output power and an auto reset
Open Circuit Output Voltage	<60V DC (max)

Notes for Table 2:

1. The Vesta Flex Dual Channel 30W Driver has two independent output channels, one for cool white and one for warm white. Each channel generates up to 1400mA output current. The maximum combined current from both output channels is also 1400mA. For example, when one channel generates a current of 1000mA, the other channel is limited to a current of 400mA.
2. The output current variation tolerance between channels applies when both channels are commanded to have an equal output current.
3. For more detail on efficiency, power factor and THD, please see Figures 2, 3 and 4.
4. Standby power specifications only apply to the driver when the LEDs are commanded to off and the controls are idling. These standby power specifications do not include the standby power of the Vesta Flex Control Module. For standby power specifications of the Vesta Flex Control Modules please refer to their respective data sheets on <https://bridgelux.com>.

Electrical Characteristics

Figure 1: Output Current Operating Range

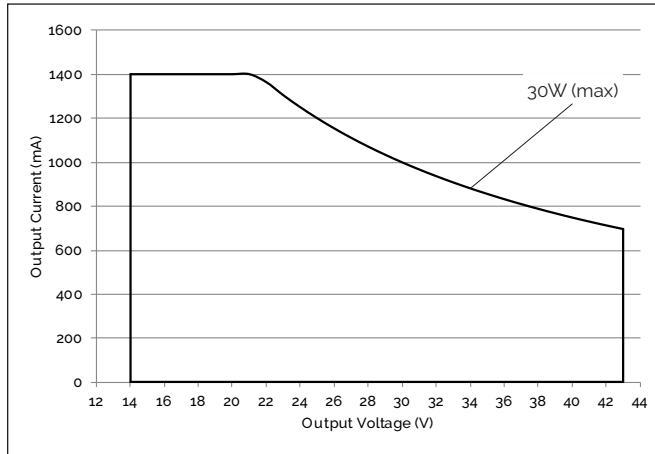

Notes for Figure 1:

- The programmable maximum output current is 1400mA. For more information on how to program the maximum output current, please visit the "Driver Programming" section on page 5.

Figure 2: Efficiency vs. Output Power

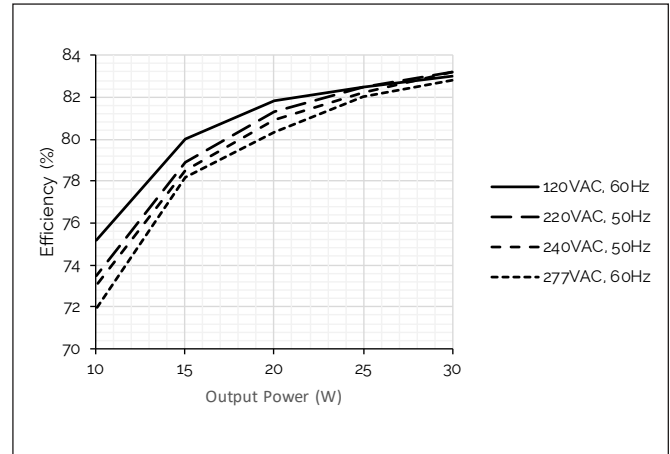

Figure 3: Power Factor vs. Output Power

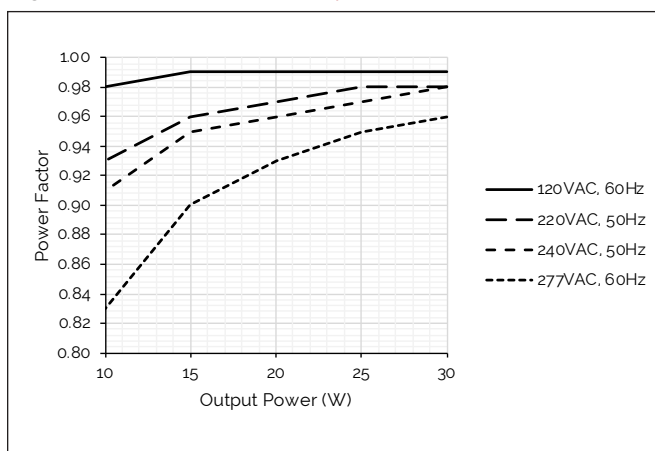
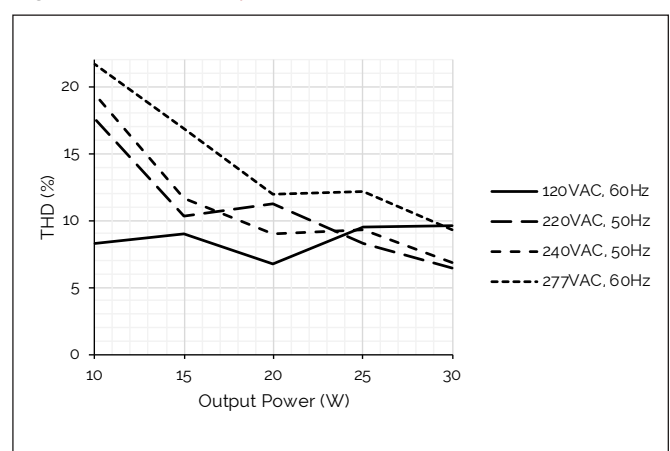

Figure 4: THD vs Output Power



Note for Figures 2, 3 and 4:

- Graphs represent typical performance at an ambient temperature of 25°C. The driver was tested with a 30W maximum LED load. Testing at output power levels below the 30W maximum was performed by dimming the light output.

Table 3: Flicker Specifications

Specification	Performance
IEEE P1789	Compliant with "No Effect" Region
NEMA 77-2017	Compliant
CEC Title 24 JA8	Compliant

Driver Programming

The Vesta Flex Dual Channel Driver provides an NFC port, which allows for programming specific driver settings in accordance with customer preferences. The Driver does not need to be powered during the programming of the driver settings.

Bridgelux provides a NFC programmer for programming the Vesta Flex Dual Channel Driver. For more information on the programmer, please see the Vesta Flex NFC Programmer DS 470 data sheet on www.bridgelux.com or contact your local Bridgelux sales representative.

Table 4: Programmable Driver Settings

Programming Parameter	Programming Options	Default Setting
Maximum combined output current	1mA - 1400mA, in 1mA increments	1400mA
Dimming profile	Linear, Square, Logarithmic	Square
Over temperature protection overwrite	On, Off	On
Over temperature protection maximum temperature setpoint	75°C, 80°C, 85°C, 90°C	90°C
Minimum dimming levels	0.1%, 1%, 5%, 10%	0.1%
Fade times ¹	0.5s, 0.75s, 1.0s, 1.25s, 1.5s	0.5s

Notes for Table 4:

1. Fade times are defined as the time it takes to tune intensity or CCT from one end of the dimming or tuning range to the other end. When tuning in between these range limits, the fade time is proportional to the shorter tuning range.

Intensity Dimming and CCT Tuning Characteristics

Figure 5: Intensity Dimming Profile Characteristics

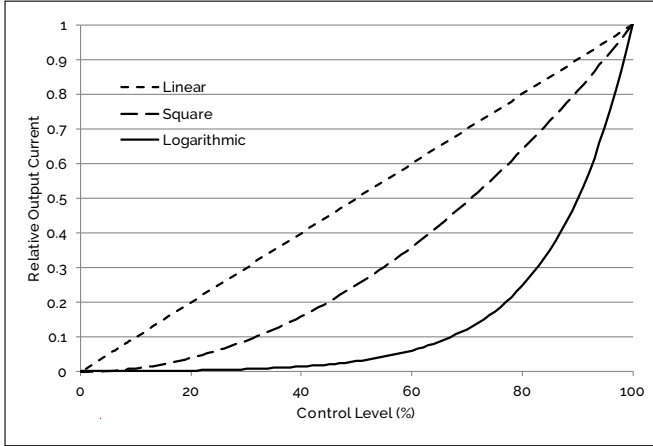
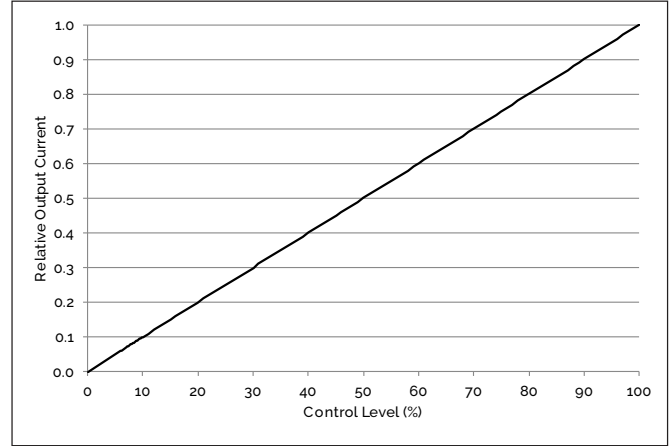

Figure 6: CCT Tuning Characteristics



Note for Figure 5:

1. When connecting a Vesta Flex DALI-2 Control Module to the Vesta Flex Driver, then its dimming characteristics defaults to linear. In a DALI-2 system, dimming characteristics may be programmed in a DALI-2 compatible controller in accordance with IEC 62386-102: 9.3.

Figure 7: CCT Tuning Operating Range

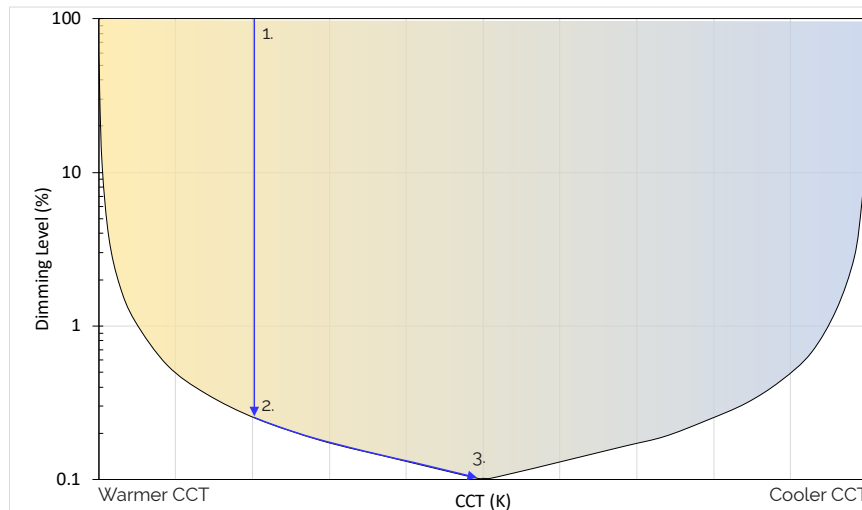

Notes for Figure 7:

1. This graph represents the CCT tuning characteristics over the dimming range of the driver. The shaded area in the graph represents possible CCT tuning and dimming combinations. Any CCT and dimming combinations below the shaded area are unattainable.
2. When dimming brightness at a set CCT (1) and the dimming level reaches the minimum dimming level at the set CCT (2), then, the CCT may shift and follow the graph until the dimming level reaches the programmed value, e.g. 0.1% (3) in the example shown above. This CCT shift can be eliminated or greatly minimized by selecting a higher minimum dim level, for example 0.5%, 1% or 10%.
3. Below the programmed minimum dimming level, the Driver dims-to-off and the current in both channels goes to 0mA.

Configuration



Table 5: Connector Configuration

Feature	Universal 120 - 277VAC Terminal	Dual Channel LED Output	Control Port
Type	Poke-In Terminal Block with Release	Poke-In Terminal Block with Release	RJ45 Terminal Block
AWG Wire Size	16 - 20	16 - 20	n.a.
Wire Type ¹	Solid Core, Stranded or Stranded Tinned	Solid Core, Stranded or Stranded Tinned	Cat cable as defined by TIA/EIA-568
Wire Strip Length	8.5 - 9.5mm	8.5 - 9.5mm	n.a.

Note for Table 5:

1. Bridgelux recommends the use of the Vesta Flex Wire Release tool when inserting and releasing wires from the poke-in terminal block. For more information on the Vesta Flex Wire Release tool, please contact your Bridgelux sales representative.

Control port connection

Vesta Flex Dual Channel Driver is designed to connect with any Vesta Flex Control Module out-of-the-box. An 8P8C category ethernet cable with RJ45 connectors may be used to connect the driver and the control module via their RJ45 ports. The communication between the Driver and the Control Module takes place via a proprietary dual channel PWM signal. The Vesta Flex Dual Channel Driver will not work without this PWM signal provided by a Vesta Flex Control Module. Vesta Flex Control Modules are available in a variety of wired and wireless control protocols, including BLE-mesh, Wi-Fi, DALI and 0-10V.

Although the Vesta Flex Dual Channel Driver and Vesta Flex Control Modules can be connected with any 8P8C category Ethernet cable via its RJ45 ports, Bridgelux recommends the use of Ethernet cables that are commonly available and recognized by the TIA (Telecommunications Industries Association), for example Cat5e, Cat6 or Cat6a cables. The maximum length of the Ethernet cable is 300m.

Mechanical Characteristics

Table 6: Driver Mechanical Characteristics

Characteristics	Specification
Dimensions (without mounting studs)	104mm (L) x 76mm (W) x 25mm (H)
Enclosure Material ¹	Metal
Weight	385 grams
Ingress Protection	IP20

Note for Table 6:

1. The driver is fully potted to provide protection and a thermal path for its electronic components and circuitry

Figure 8: Mechanical Drawing

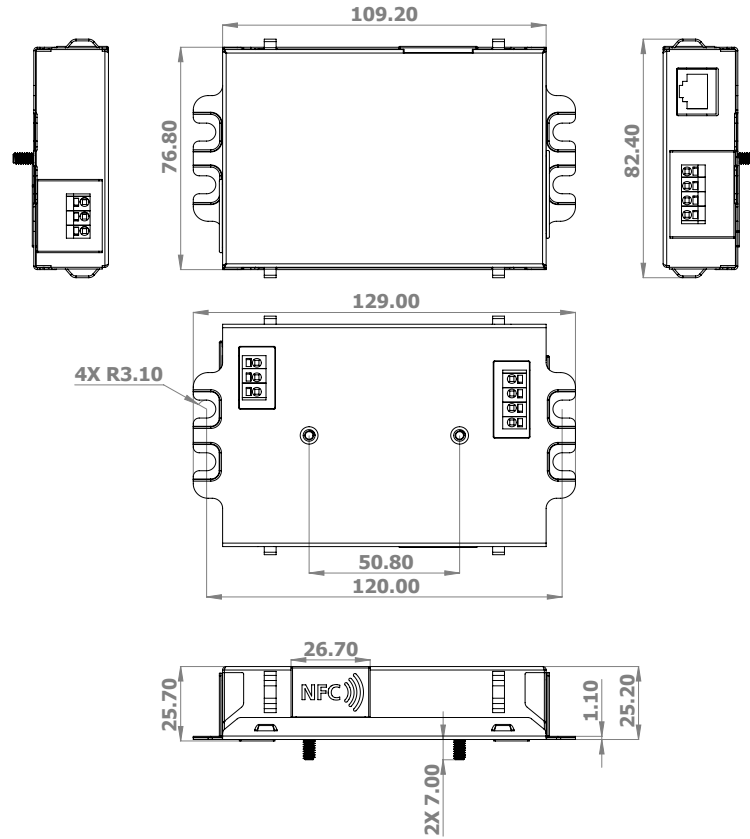

Notes for Figure 8:

1. Drawing dimensions are in millimeters
2. Unless otherwise specified, all linear tolerances are +/-1.0mm
3. Use #10 or M5 fastener in the mounting slots for anchoring the driver in position
4. Use #8 nut on mounting studs for fastening driver in position

Mechanical Characteristics

Table 7: Driver With Strain Relief Mechanical Characteristics

Characteristics	Specification
Dimensions	164.2 mm (L) x 81.9 mm (W) x 24.5 mm (H)
Enclosure Material ¹	Metal (driver), Plastic (strain relief)
Weight	440grams
Ingress Protection	IP20

Note for Table 7:

1. The driver is fully potted to provide protection and a thermal path for its electronic components and circuitry

Figure 9: Mechanical Drawing

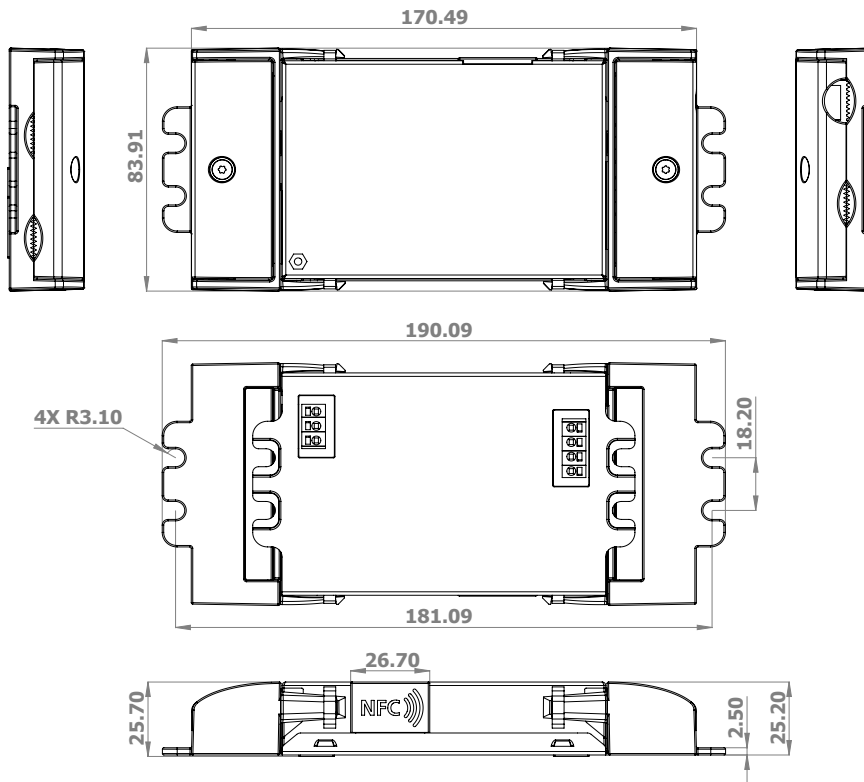

Notes for Figure 9:

1. Drawing dimensions are in millimeters
2. Unless otherwise specified, all linear tolerances are +/-1.0mm
3. Use #10 or M5 fastener either in the driver mounting slots or in the strain relief mounting slots for anchoring the driver in position

Figure 10: Strain Relief Feature Map

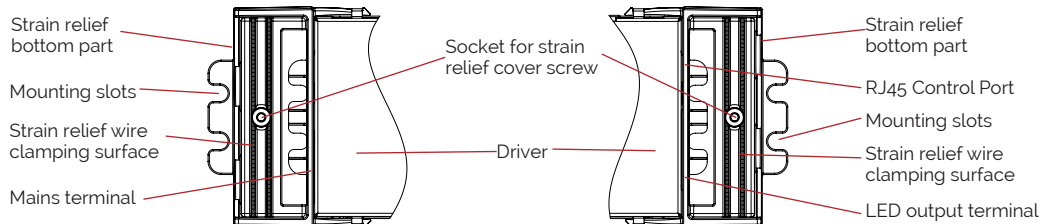

Notes for Figure 10:

1. Drawing shows strain relief without cover.
2. Make sure that cables and wires are properly positioned on the strain relief clamping surface when mounting the strain relief cover part.
3. Make sure that the strain relief cover part is mounted properly to assure adequate clamping force.

Environmental and Regulatory Standards

Table 8: Environmental Conditions

Parameter	Specification		
Case Temperature, T _c	+90°C (max)		
Ambient Operating Temperature	-40°C to +60°C		
Humidity Ratings	Maximum 85% Relative Humidity, non condensing		
Operating Environment	For indoor use only		
Storage Temperature	-20°C to +70°C		
MTBF	300,000 hrs at T _c = 80°C		
Over-Temperature Protection ^{1,2}	Case Temperature	Relative Commanded Output Current	Case Temperature Threshold Example
	≥ programmed T _c -max Setpoint ³	80%	≥ +90°C (default T _c -max setpoint)
	≥ programmed T _c -max Setpoint plus 5°C ³	60%	≥ +95°C
	≥ programmed T _c -max Setpoint plus 10°C ³	40%	≥ +100°C
	≥ programmed T _c -max Setpoint plus 15°C ³	20%	≥ +105°C
	≥ programmed T _c -max Setpoint plus 20°C ³	0%	≥ +110°C
	≤ programmed T _c -max Setpoint minus 5°C ³	100% (auto recovery)	≤ +85°C

Notes for Table 8:

1. See table 5 for disabling the Over-Temperature Protection function or programming different maximum case temperature setpoints.
2. The Over-Temperature Protection feature has a 10s fade time when transitioning from one state to another.
3. The programmed T_c-max set point, the T_c-max set point plus 5°C, 10°C, 15°C, 20°C and the T_c-max Setpoint minus 5°C have a tolerance of ±5%.

Table 9: Regulatory Approvals and Compliance

Specification	Description
UL 8750, rated for dry and damp locations, (Class 2)	UL safety standard for Light Emitting Diode (LED) equipment for use in lighting products
Category FKSZ/7, file number E506581, (Class P)	UL evaluation and testing guidelines for standardized LED driver constructions and ratings
EN 61347-2-13:2014 + A1:2017, CE, ENEC	IEC specification that specifies particular safety requirements for electronic controlgear for use on D.C.. or A.C. supplies in lighting applications
EN 55015:2013	Limits and methods of measurement of radio disturbance characteristics of electrical lighting and similar equipment
EN 61547:2009	International Standard for electromagnetic immunity requirements applicable to lighting equipment
EN 61000-3-2:2013	Electromagnetic compatibility (EMC). Limits of voltage changes, voltage fluctuations and flicker in low-voltage supply systems
EN 61000-3-2:2014	Limitation of harmonic currents injected into the public supply system
IEC 60950-1	Standard for power supplies meeting the Safety Extra Low Voltage (SELV) specification
RoHS 3	Restriction of Hazardous Substances directive

Packaging

Table 10: Packaging Box Configuration for Brick Driver

Parameter	Specification
Driver quantity	25 pcs
Outer dimensions	458 mm x 153 mm x 185 mm
Weight	10.8 kg

Notes for Table 10:

1. Packaging Box configuration applies to part numbers BXDR-30BT-U214P-01-A

Figure 11: Packaging Box Design

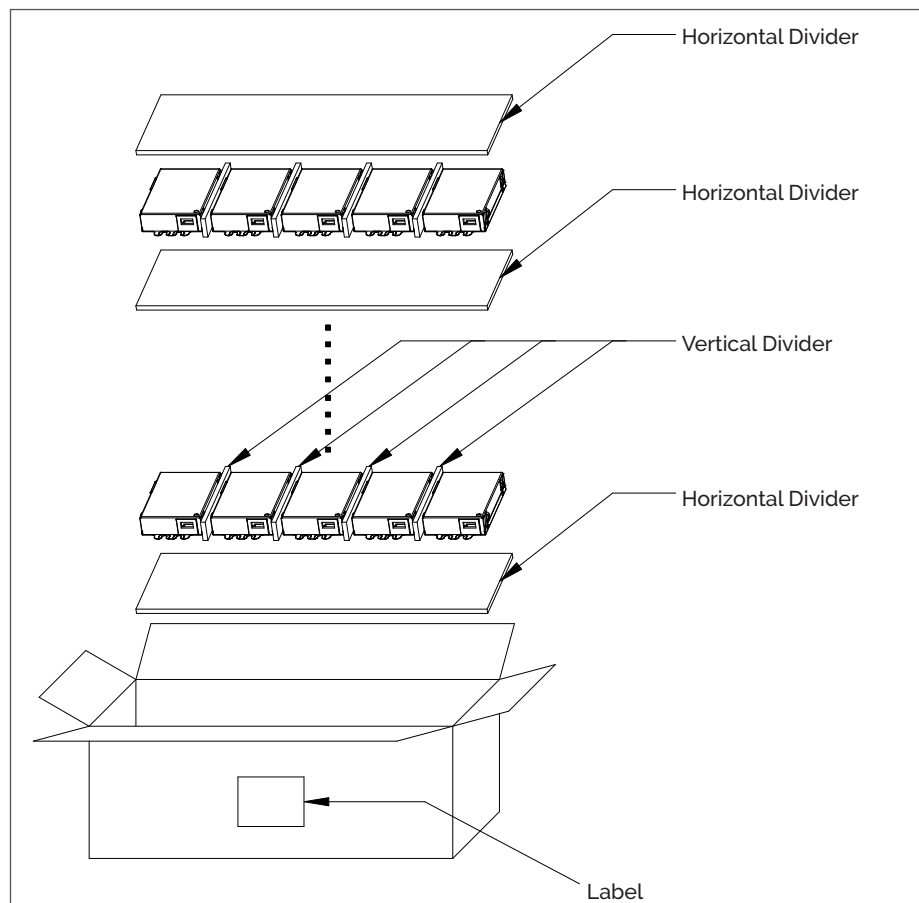

Notes for Figure 11:

1. Each box contains 5 layers with 5 drivers in each layer. Each layer is separated by horizontal dividers. There are 6 horizontal dividers per box.
2. Each of the 5 drivers in a layer are separated by vertical dividers. There are 4 vertical dividers per layer.

Packaging

Table 11: Packaging Box Configuration for Brick Driver with stud mount option

Parameter	Specification
Driver quantity	25 pcs
Outer dimensions	458 mm x 153 mm x 225 mm
Weight	10.8 kg

Notes for Table 11:
 1. Packaging Box configuration applies to part numbers BXDR-30ST-U214P-01-A.

Figure 12: Packaging Box Design

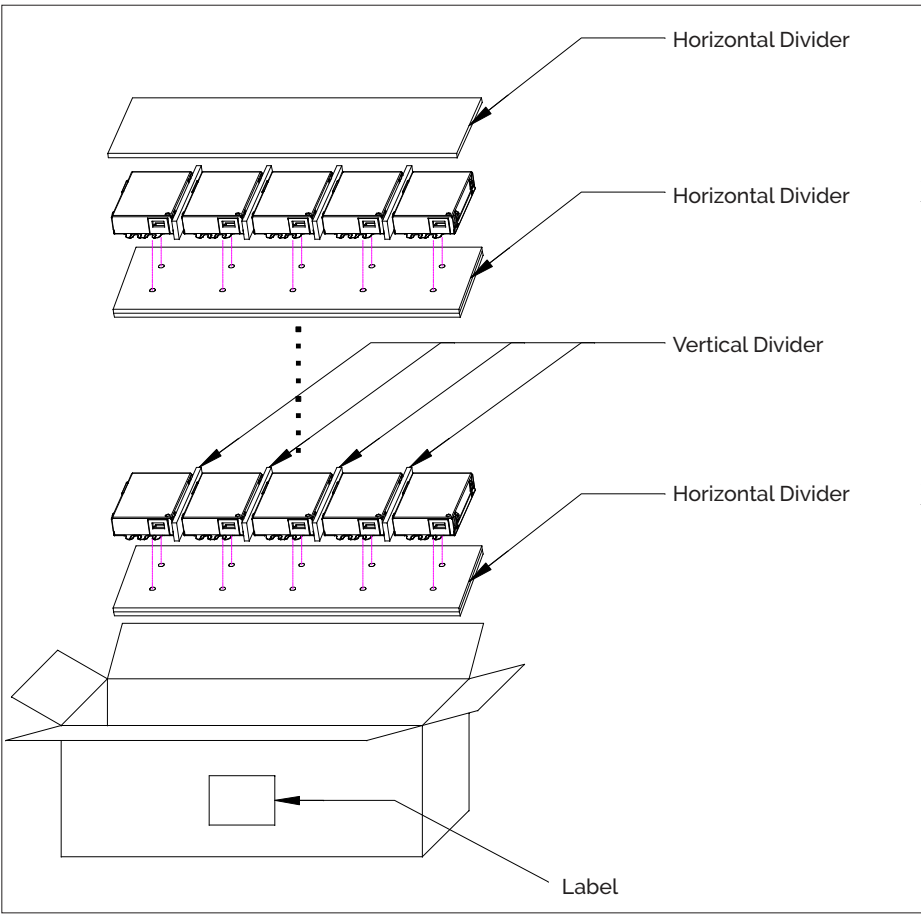

Notes for Figure 12:
 1. Each box contains 5 layers with 5 drivers in each layer. Each layer is separated by horizontal dividers. There are 6 horizontal dividers per box.
 2. Each of the 5 drivers in a layer are separated by vertical dividers. There are 4 vertical dividers per layer.

Packaging

Table 12: Packaging Box Configuration for Brick Driver with strain relief option

Parameter	Specification
Driver quantity	25 pcs
Outer dimensions	458 mm x 215 mm x 185 mm
Weight	11.3 kg

Notes for Table 12:

1. Packaging Box configuration applies to part numbers BXDR-30BS-U214P-01-A.

Figure 13: Packaging Box Design

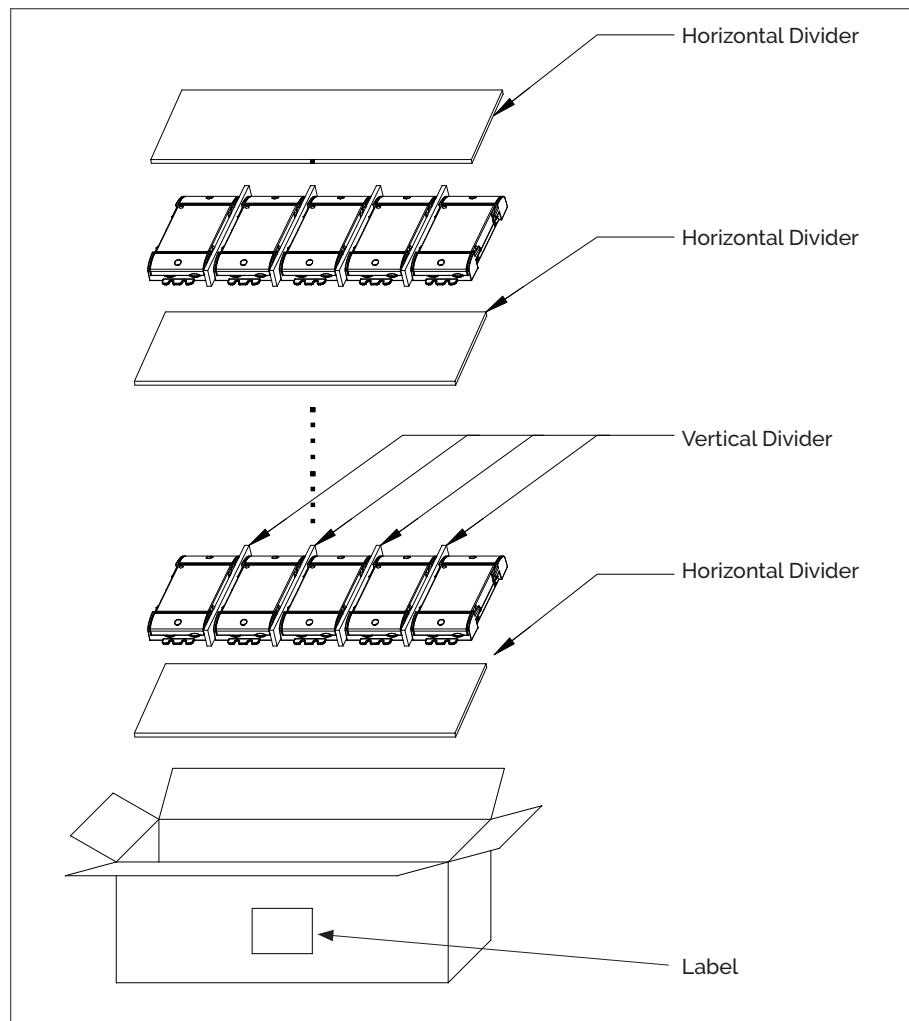

Notes for Figure 13:

1. Each box contains 5 layers with 5 drivers in each layer. Each layer is separated by horizontal dividers. There are 6 horizontal dividers per box.
2. Each of the 5 drivers in a layer are separated by vertical dividers. There are 4 vertical dividers per layer.

Design Resources

Application Notes

Please contact your Bridgelux sales representative for assistance on obtaining application support when designing with the Bridgelux Vesta Flex Dual Channel Driver. For a list of available resources, visit www.bridgelux.com.

3D CAD Models

CAD models depicting the Vesta Flex Dual Channel Driver are available in both IGES and STEP formats. Please contact your Bridgelux sales representative for assistance.

Precautions

CAUTION: PRODUCT HANDLING

Handle the Vesta Flex Dual Channel Driver with care to prevent any damage from mechanical shock

It is recommended to handle this driver in a static-free environment

Do not open or disassemble the product

To maintain product warranty, the installer is responsible for ensuring that the driver's operating conditions do not exceed the maximum conditions stated within this data sheet

CAUTION: PRODUCT INSTALLATION

Incorrect installation of the Vesta Flex Dual Channel Driver can cause irreparable damage to the driver, connected LEDs or connected Vesta Flex control modules.

Pay attention when connecting the LED load and observe the correct polarity of the output terminals as specified in this data sheet and on the driver label.

WARNING: ELECTRIC SHOCK

Be aware of the possibility of an electric shock hazard which can result in serious injury or death. Disconnect power before servicing or installing this device.

Disclaimers

MINOR PRODUCT CHANGE POLICY

The rigorous qualification testing on products offered by Bridgelux provides performance assurance. Slight cosmetic changes that do not affect form, fit, or function may occur as Bridgelux continues product optimization.

About Bridgelux: Bridging Light and Life™

At Bridgelux, we help companies, industries and people experience the power and possibility of light. Since 2002, we've designed LED solutions that are high performing, energy efficient, cost effective and easy to integrate. Our focus is on light's impact on human behavior, delivering products that create better environments, experiences and returns—both experiential and financial. And our patented technology drives new platforms for commercial and industrial luminaires.

For more information about the company, please visit
bridgelux.com
twitter.com/Bridgelux
facebook.com/Bridgelux
youtube.com/user/Bridgelux
linkedin.com/company/bridgelux
WeChat ID: BridgeluxInChina



46430 Fremont Blvd
Fremont, CA 94538 USA
Tel (925) 583-8400
www.bridgelux.com

© 2020 Bridgelux, Inc. All rights reserved 2020. Product specifications are subject to change without notice. Bridgelux, the Bridgelux stylized logo design and Vesta are registered trademarks of Bridgelux, Inc. Bridging Light and Life is a trademark of Bridgelux, Inc. All other trademarks are the property of their respective owners.

Bridgelux Vesta Flex Dual Channel 30W Driver Data Sheet DS451 Rev. A (09/2020)