

LOC	DIST	REV	DATE	BY	APPV
A1	-	J2	26MAY08	EW	AW
		J3	19DEC09	KK	AEG
		K1	09AUG2010	ER	AW
		L1	23MAR2011	ER	AW

TRAY WITH SMALL PARTS STORAGE BOXES
KOFFEREINSATZ MIT KLEINTEILEMAGAZINE

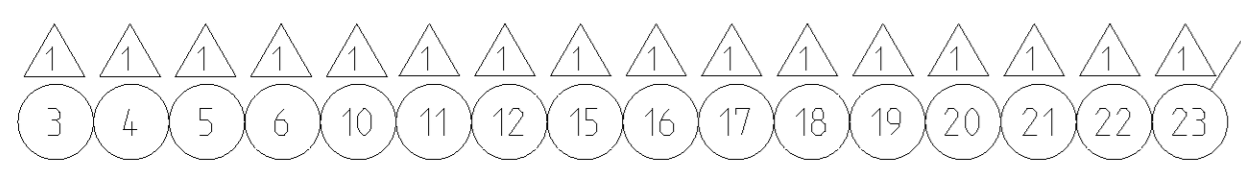
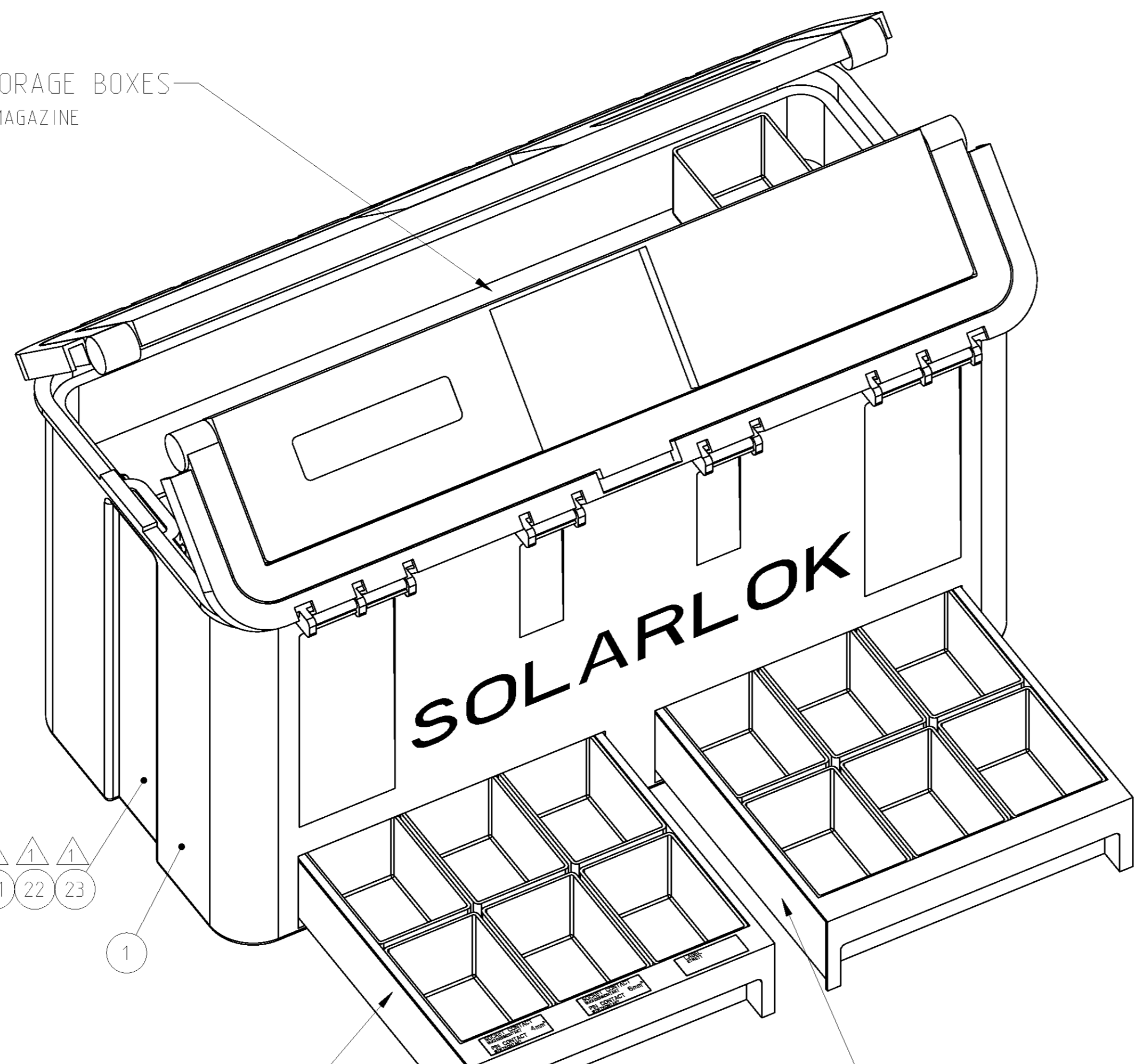

- △ INSERTED IN SOLARLOK BAG
- △ 50 PIECES PHOTOVOLTAIK CONNECTOR 1 POS. PREASSEMBLED (ITEM NO. 3, 4, 5 OR 6) PACKAGED IN PLASTIC BAG
- △ 50 PIECES SOCKET CONTACT ASSY HVT. 4mm² / AWG 12 PN 1987281-2 FROM PHOTOVOLATIK CONNECTOR PN 1394462-3 (ITEM NO. 4) OR PN 1394462-4 (ITEM NO. 6)
- △ 50 PIECES PIN CONTACT ASSY HVT. 4mm² / AWG 12 PN 1987280-2 FROM PHOTOVOLATIK CONNECTOR PN 1394461-3 (ITEM NO. 3) OR PN 1394461-4 (ITEM NO. 5)
- 5 ASSEMBLED SOLARLOK BAG PACKAGED IN CARDBOARD BOX
- △ OBSOLETE PARTS: OBSOLETE CIS STREAMLINING

- △ IN SOLARLOK-KOFFER EINGELEGT
- △ 50 STUECK VORASSEMBLIERTE PHOTOVOLTAIK STECKVERBINDER 1 POL. (ITEM NO. 3, 4, 5 ODER 6) VERPACKT IN KUNSTSTOFF-BEUTEL
- △ 50 STUECK BUCHSENKONTAKT ASSY HVT. 4mm² / AWG 12 PN 1987281-2 AUS PHOTOVOLATIK STECKVERBINDER PN 1394462-3 (ITEM NO. 4) ODER PN 1394462-4 (ITEM NO. 6)
- △ 50 STUECK STIFTKONTAKT ASSY HVT. 4mm² / AWG 12 PN 1987280-2 AUS PHOTOVOLATIK STECKVERBINDER PN 1394461-3 (ITEM NO. 3) ODER PN 1394461-4 (ITEM NO. 5)
- 5 BESTUECKTER SOLARLOK-KOFFER IN KARTON VERPACKT
- △ VERALTETE TEILE: VERALTET NACH CIS STREAMLINING

DRAWER WITH SMALL PARTS STORAGE BOXES, LEFT
SCHUBLADE MIT KLEINTEILEMAGAZINE, LINKS

DRAWER WITH SMALL PARTS STORAGE BOXES, RIGHT
SCHUBLADE MIT KLEINTEILEMAGAZINE, RECHTS

REAR VIEW
RÜCKANSICHT

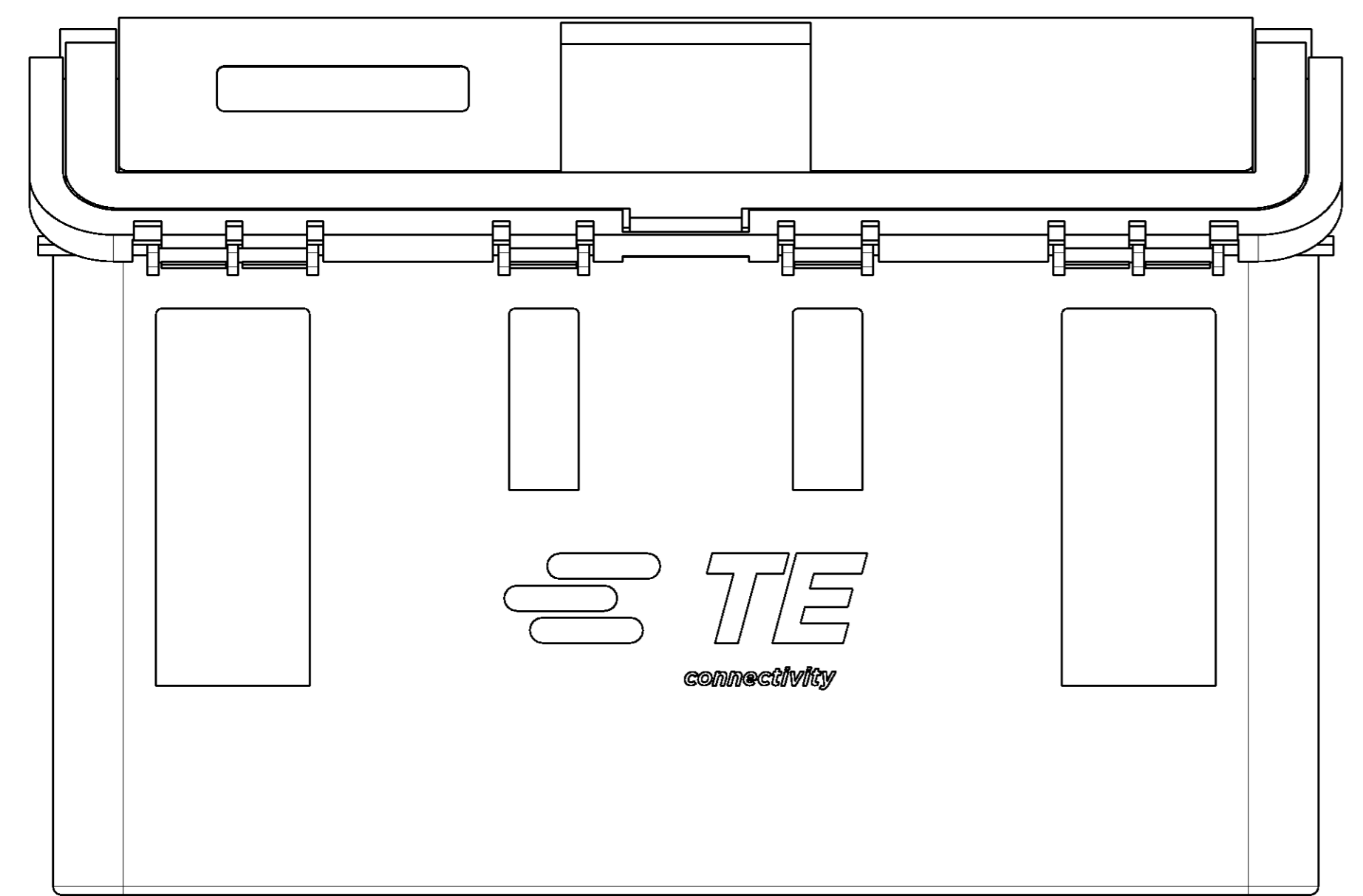

QTY	RECD	PER	ASSY	PARTNUMBER	DESCRIPTION	ITEM NO
-	-	-	1	1654276-1	SOLARLOK INTERCONNECTION SYSTEM INSTALLATION MANUAL	23
-	-	-	30	-	PINCH RING SEAL, ASSY	22
-	-	-	50	1987424-1	COVER FOR PHOTOVOLTAIK CONNECTOR	21
-	-	-	50	1987419-1	PLUG COVER	20
-	-	-	20	2106207-1	SOLARLOK SAFETY COLLAR	19
-	-	1	1	-	CUSTOMER DRAWING PN 1394462	18
-	-	1	1	-	CUSTOMER DRAWING PN 1394461	17
-	-	1	1	411-18305-1	INSTRUCTION SHEET	16
-	-	1	1	-	CUSTOMER DRAWING PN 1534858	15
-	-	1	-	8-1579001-2	VARIO CRIMP HEAD AWG 10	14
-	-	1	-	1-1579004-9	SOLARLOK HAND CRIMPING TOOL - AWG 12	13
-	-	-	1	1-1579004-2	SOLARLOK HAND CRIMPING TOOL - METRIC	12
-	-	1	1	4-1579002-2	INSULATION STRIPPER	11
-	-	1	1	1102855-3	EXTRACTION TOOL	10
-	-	100	100	1718077-1	LABEL, DO NOT DISCONNECT UNDER LOAD	9
-	-	100	100	1987280-4	PIN CONTACT ASSY HVT. 6mm ² / AWG 10	8
-	-	100	100	1987281-3	SOCKET CONTACT ASSY HVT. 6mm ² / AWG 10	7
-	-	50	50	1394462-4	PHOTOVOLATIK CONNECTOR 1 POS. (SOCKET, MINUS 4mm ² / AWG 12)	6
-	-	50	50	1394461-4	PHOTOVOLATIK CONNECTOR 1 POS. (PIN, MINUS 4mm ² / AWG 12)	5
-	-	50	50	1394462-3	PHOTOVOLATIK CONNECTOR 1 POS. (SOCKET, PLUS 4mm ² / AWG 12)	4
-	-	50	50	1394461-3	PHOTOVOLATIK CONNECTOR 1 POS. (PIN, PLUS 4mm ² / AWG 12)	3
-	-	1	-	-	SOLARLOK BAG	2
-	-	1	-	-	SOLARLOK BAG	1
-	-	-2	-1	PARTNUMBER	DESCRIPTION	ITEM NO

THIS DRAWING IS A CONTROLLED DOCUMENT. DATE: 15-MAY-02. RELEASED FOR PUBLICATION FOR THIS REFERENCE ONLY. ALL RIGHTS RESERVED. AUTOMATICALLY GENERATED BY PRO/ENGINEER DRAWING.

TE Connectivity

SOLARLOK BAG, ASSEMBLED
SOLARLOK-KOFFER, BESTUECKT

SCALE: 1:2

REV 1

LOC	DIST	REV	LTB	REVISIONS ÄNDERUNGEN	DATE	DWN	APPV
A1	-	-	-	DESCRIPTION BESCHREIBUNG	-	-	-
PROJECT NO. EGGIC02029				SEE SHEET 1			

TRAY WITH SMALL PARTS STORAGE BOXES
 KOFFEREINSATZ MIT KLEINTEILEMAGAZINE

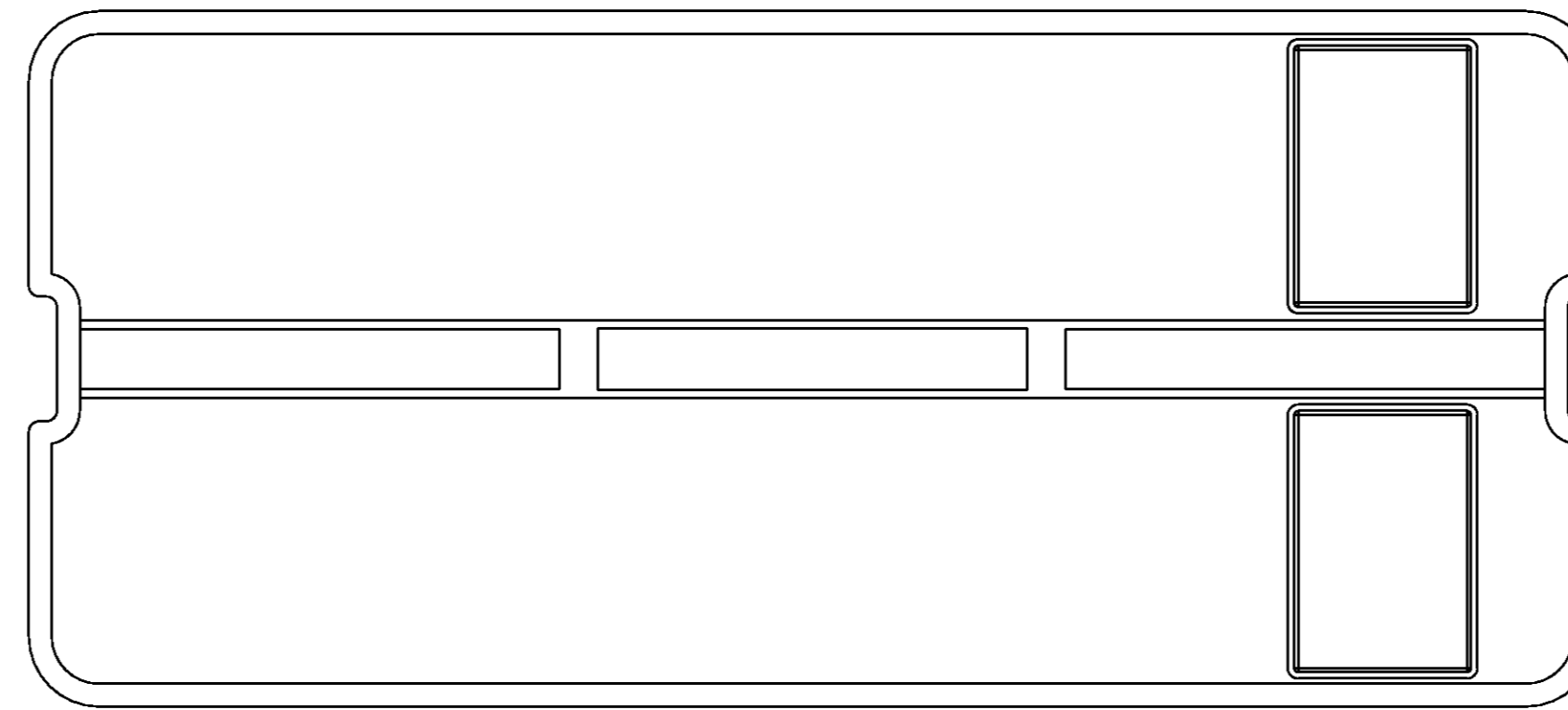

DRAWER WITH SMALL PARTS STORAGE BOXES, LEFT
 SCHUBLADE MIT KLEINTEILEMAGAZINE, LINKS
 SCALE 1:1 / M 1:1

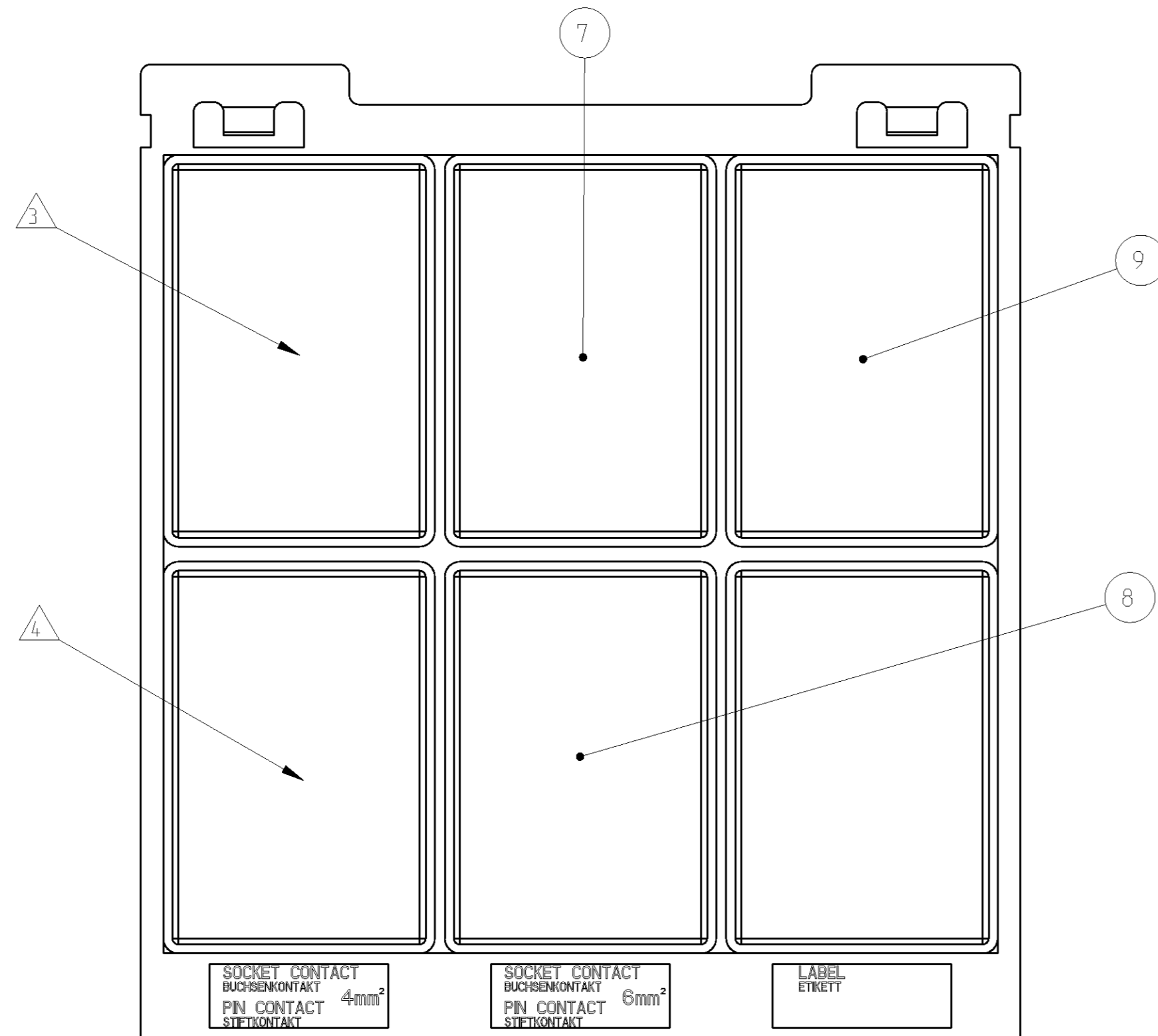

DRAWER WITH SMALL PARTS STORAGE BOXES, RIGHT
 SCHUBLADE MIT KLEINTEILEMAGAZINE, RECHTS
 SCALE 1:1 / M 1:1

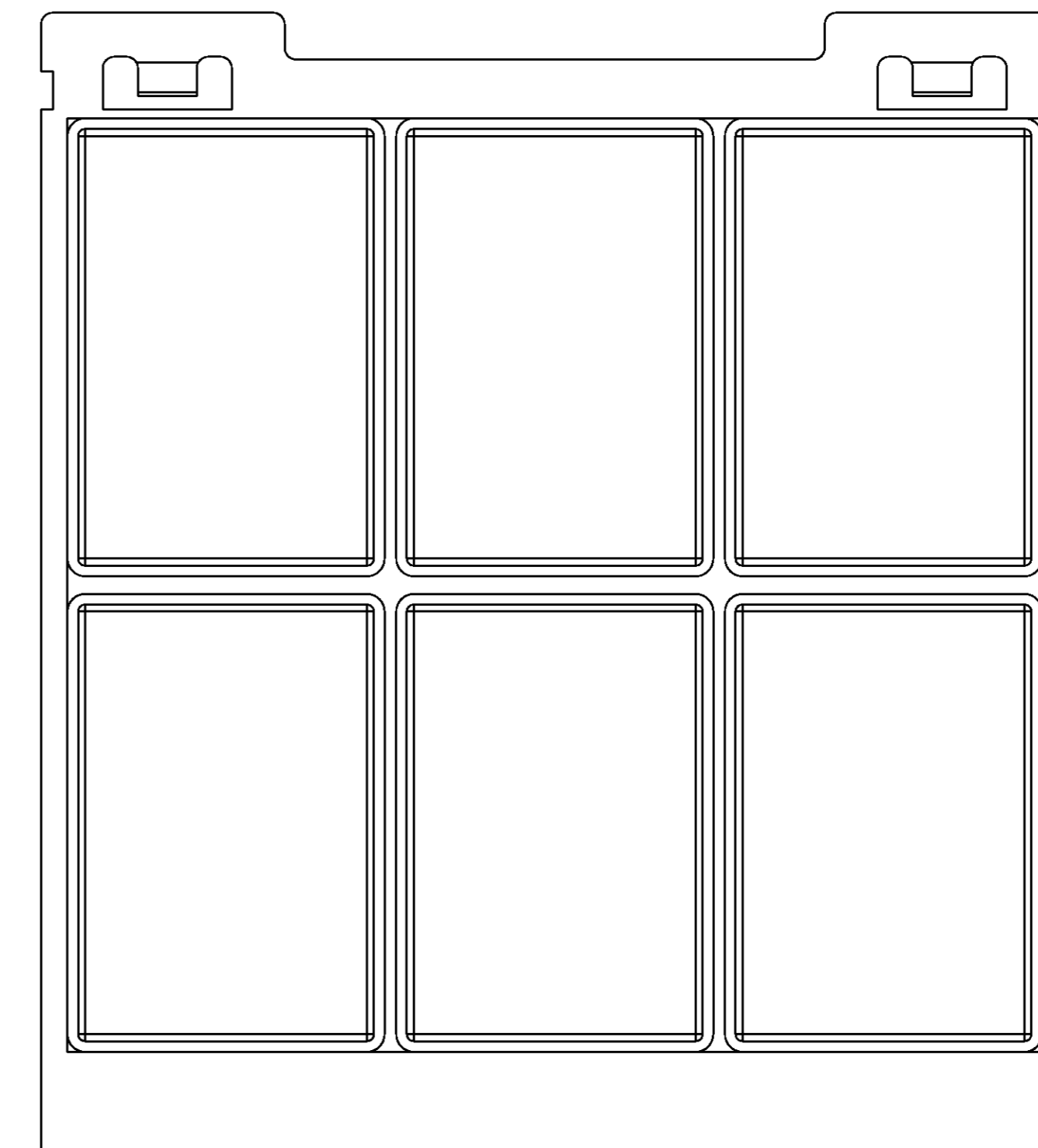

-1 AS SHOWN
 -1 WIE GEZEICHNET

THIS DRAWING IS A CONTROLLED DOCUMENT. <small>DEUTSCH: DOKUMENTENNUMMERN UND DATUM SIND VERBODEN ZU VERÄNDERN. ANDERSON: THE DATE AND DOCUMENT NUMBER ARE UNCLASSIFIED EXCEPT WHERE SHOWN OTHERWISE.</small>		DWN E. WERNER 15-MAY-02	 TE Connectivity
<small>ALLE DIMENSIONEN SIND IN MILLIMETERN ANZUGEN UNLESS OTHERWISE SPECIFIED: ALLE DIMENSIONEN SIND IN MILLIMETERN ANZUGEN UNLESS OTHERWISE SPECIFIED.</small>		CHK H. SCHERER 15-MAY-02	
<small>ALLE DIMENSIONEN SIND IN MILLIMETERN ANZUGEN UNLESS OTHERWISE SPECIFIED: ALLE DIMENSIONEN SIND IN MILLIMETERN ANZUGEN UNLESS OTHERWISE SPECIFIED.</small>		APPV G. FEILDMAYER 15-MAY-02	NAME SOLARLOK BAG, ASSEMBLED SOLARLOK-KOFFER, BESTUECKT
<small>ALLE DIMENSIONEN SIND IN MILLIMETERN ANZUGEN UNLESS OTHERWISE SPECIFIED: ALLE DIMENSIONEN SIND IN MILLIMETERN ANZUGEN UNLESS OTHERWISE SPECIFIED.</small>		PRODUCT SPEC - APPLICATION SPEC - WEIGHT - CUSTOMER DRAWING	RESTRICTED TO NUR FÜR -
<small>ALLE DIMENSIONEN SIND IN MILLIMETERN ANZUGEN UNLESS OTHERWISE SPECIFIED: ALLE DIMENSIONEN SIND IN MILLIMETERN ANZUGEN UNLESS OTHERWISE SPECIFIED.</small>		SIZE A1	SCALE 1:2
<small>ALLE DIMENSIONEN SIND IN MILLIMETERN ANZUGEN UNLESS OTHERWISE SPECIFIED: ALLE DIMENSIONEN SIND IN MILLIMETERN ANZUGEN UNLESS OTHERWISE SPECIFIED.</small>		CASE CODE 00779	DRAWING NO. 1534858
<small>ALLE DIMENSIONEN SIND IN MILLIMETERN ANZUGEN UNLESS OTHERWISE SPECIFIED: ALLE DIMENSIONEN SIND IN MILLIMETERN ANZUGEN UNLESS OTHERWISE SPECIFIED.</small>		SHEET 2	OF 3
<small>ALLE DIMENSIONEN SIND IN MILLIMETERN ANZUGEN UNLESS OTHERWISE SPECIFIED: ALLE DIMENSIONEN SIND IN MILLIMETERN ANZUGEN UNLESS OTHERWISE SPECIFIED.</small>		REVISION 1	DATE 15-MAY-02

LOC	DIST	F	LTB	REVISIONS	DATE	DWN	APVD
A1	-	-	-	AMENDMENT ÄNDERUNG			
				DESCRIPTION BESCHREIBUNG			
				SEE SHEET 1			

DRAWER WITH SMALL PARTS STORAGE BOXES, LEFT
 SCHUBLADE MIT KLEINTEILEMAGAZINE , LINKS

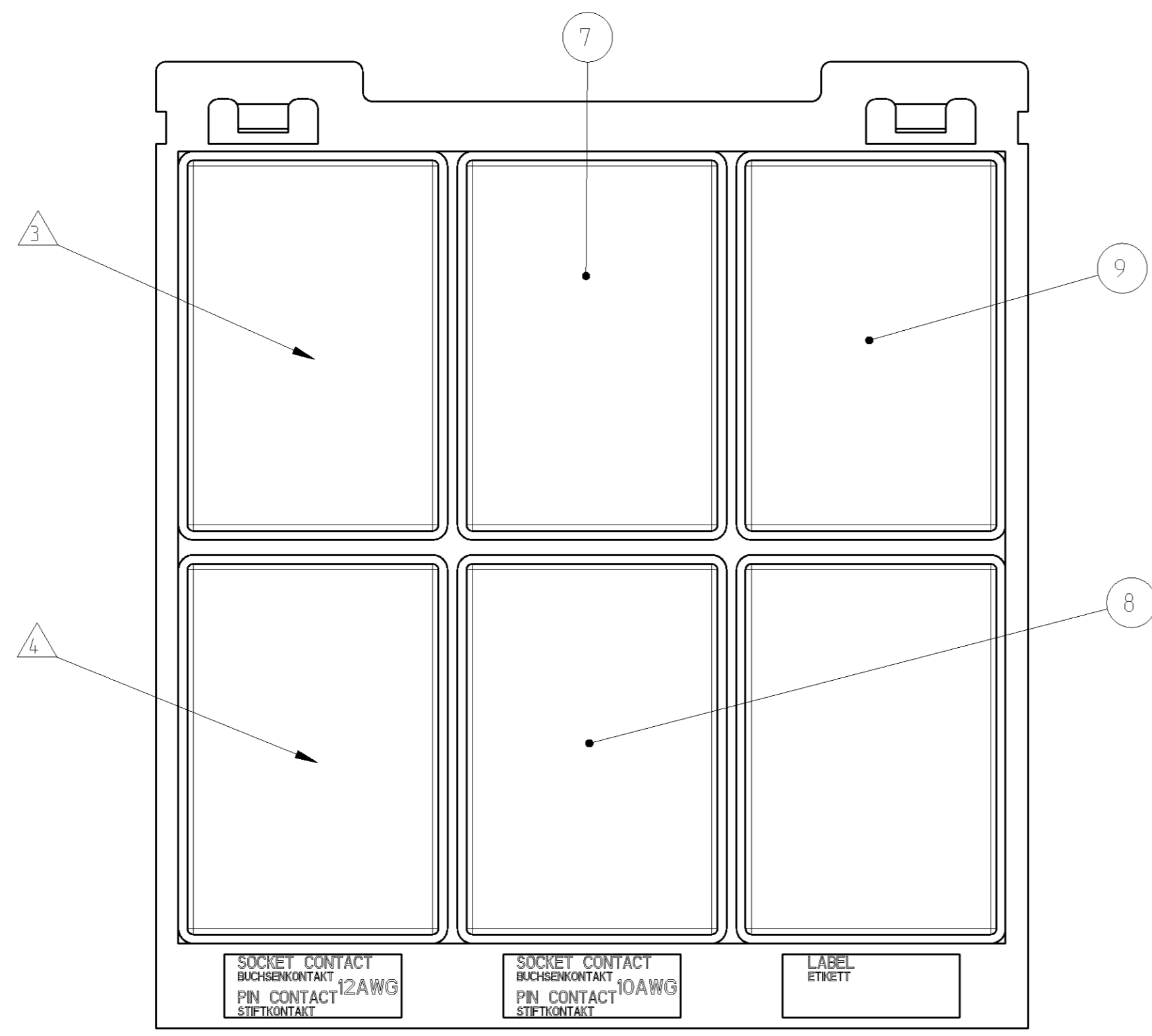

DRAWER WITH SMALL PARTS STORAGE BOXES, RIGHT
 SCHUBLADE MIT KLEINTEILEMAGAZINE , RECHTS

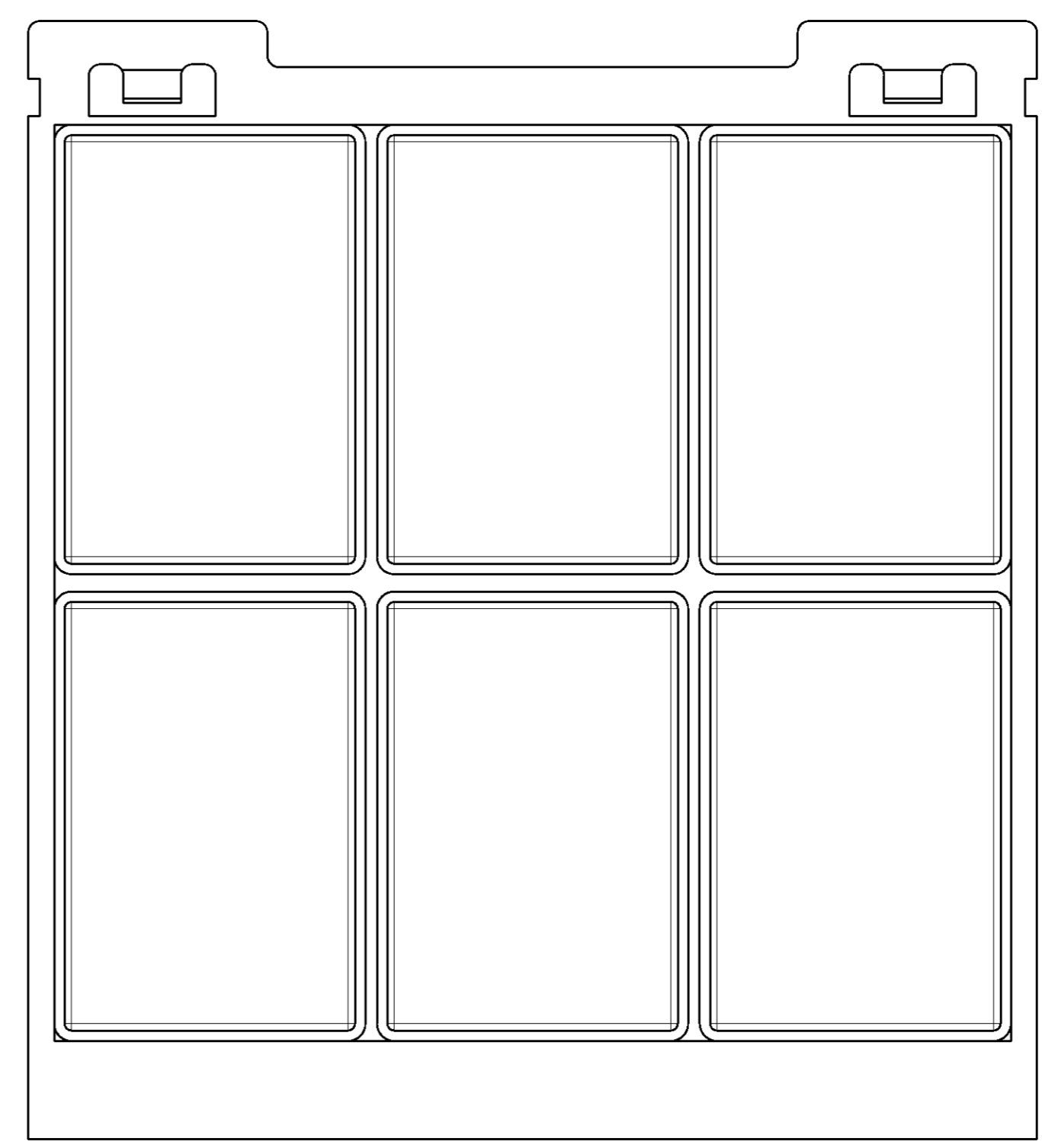

-2 OBSOLETE

-2 AS SHOWN
 -2 WIE GEZEICHNET

THIS DRAWING IS A CONTROLLED DOCUMENT. <small>DEUTSCH: DOKUMENTNUMMERNUMMER WIRD DIREKT MIT INCORPORIERTEN NUMMERNUMMERN VERBUNDEN. DIESE NUMMERNUMMERN SIND FÜR DIE VERBODEN TO VERPUBLICEEREN.</small>		DWN E. WERNER 15-MAY-02	15-MAY-02	TE Connectivity
DIMENSIONS MASSENHEITEN (mm)		CHK H. SCHERER 15-MAY-02	15-MAY-02	
TOLERANCES UNLESS OTHERWISE SPECIFIED: ALL DIMENSIONS IN MILLIMETERS		APVD G. FELDMEIER 15-MAY-02		NAME SOLARLOK BAG, ASSEMBLED SOLARLOK-KOFFER, BESTUECKT
DIMENSIONS MASSENHEITEN (mm)		0 PLC ± 1 PLC ± 2 PLC ± 3 PLC ± 4 PLC ±	PRODUCT SPEC PRODUKTSPEZ. APPLICATION SPEC VERARBEITUNGSSPEZ.	SIZE A1
MATERIAL -		FINISH/BOERENLAECHE/FARBE -	WEIGHT GEWICHT -	CASE CODE 00779
CUSTOMER DRAWING		/KUNDENZEICHNUNG		DRAWING NO. ZEICHNUNGS-NR. ©=1534858
SCALE MASSSTAB 1:2		SHEET BLATT 3 OF 3		RESTRICTED TO NUR FÜR -