

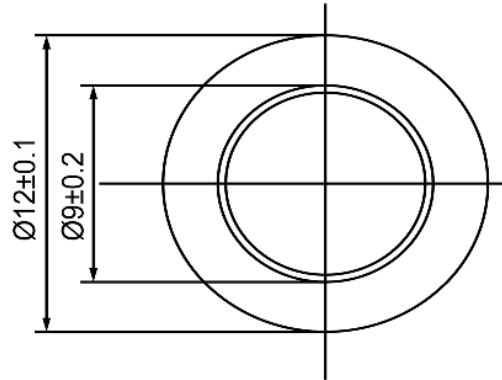

TOP VIEW

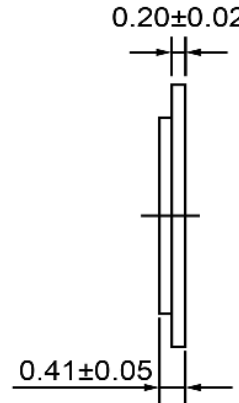

SIDE VIEW



Specifications			Notes	Revision History						
Description	Value	Unit		Version	Description		Date	Approved		
Resonant Frequency	16,500	(Hz)	1) All dimensions are in mm unless otherwise noted 2) All parts meet RoHS	1	Released from Engineering		10/21/2013	J.S		
Resonant Impedance (Max)	600	(Ohm)								
Max Input Voltage	30	(V)								
Capacitance	6,000	(pF)								
Plate Material	Brass									
Operating Temperature	-20 ~ +70	°C								
Storage Temperature	-30 ~ +80	°C								
			 DB UNLIMITED	Drawn by	Date	Checked by	Date	Approved by	Date	
				A.B.	10/21/2013	C.E.	10/21/2013	J.S	10/21/2013	
				Piezo Bender			P12165-1			

Additional considerations can be found at www.dbunlimitedco.com/technical-articles.