

LED Drivers for LCD Backlights

Multifunction Backlight LED Drivers for Small LCD Panels (Charge Pump Type)



BD6085GUL

No.11040EAT28

●Description

BD6085GUL is Multi-Function LED Driver that is the most suitable for the cellular phone. It has many functions that are needed to "the upper side" of the cellular phone.

●Features

- Total 7LEDs driver for LCD Backlight (Main/Sub) and LED Flash
It can set maximum 30mA by 32 steps (Current DAC) for Main/Sub Display
It can set maximum 360mA for Flash LED driver
(It has 3 channels LED driver at maximum 120mA/ch for Flash.)
The number of lighting for Main/Sub/Flash LED can be set up grouping by register.
Ex.) 4LEDs / 0LED / 3LEDs
4LEDs / 1LED / 2LEDs
4LEDs / 2LEDs / 1LED
4LEDs / 1LED / 1LED
5LEDs / 1LED / 1LED
5LEDs / 0LED / 2LEDs
6LEDs / 0LED / 1LED

It can use the 1LED Flash module to 3LED Flash module.
Normal mode = maximum 30mA/ch, Flash mode = x4 normal mode (for 3ch LED).
The grouping of LED is independently controlled by register.
- 4ch Series Regulator (LDO)
It has selectable output voltage by the register.
LDO1,LDO2 : I_{max}=200mA
LDO3,LDO4 : I_{max}=150mA
- Charge Pump DC/DC for LED driver
It has x1/x1.33/x1.5/x2 mode that will be selected automatically.
Soft start functions
Over voltage protection (Auto-return type)
Over current protection (Auto-return type)
- Thermal shutdown (Auto-return type)
- I²C BUS FS mode(max 400kHz)Write/Read
- VCSP50L3(3.30mm × 3.30mm, 0.55mm) Small and thin CSP package

*This chip is not designed to protect itself against radioactive rays.

*This material may be changed on its way to designing.

*This material is not the official specification.

●Absolute Maximum Ratings (Ta=25 °C)

Parameter	Symbol	Ratings	Unit
Maximum voltage	V _{MAX}	7	V
Power Dissipation	P _d	1325	mW
Operating Temperature Range	T _{opr}	-35 ~ +85	°C
Storage Temperature Range	T _{stg}	-55 ~ +150	°C

note)Power dissipation deleting is 10.6mW/ °C, when it's used in over 25 °C.

(It's deleting is on the board that is ROHM's standard)

●Operating conditions (V_{BAT}≥V_{IO}, Ta=-35~85 °C)

Parameter	Symbol	Ratings	Unit
V _{BAT} input voltage	V _{BAT}	2.7~5.5	V
V _{IO} pin voltage	V _{IO}	1.65~3.3	V

●Electrical Characteristics (Unless otherwise specified, Ta=25°C, VBAT=3.6V, VIO=1.8V)

Parameter	Symbol	Limits			Unit	Condition
		Min.	Typ.	Max.		
【Circuit Current】						
VBAT Circuit current 1	IBAT1	-	0.1	1.0	μA	RESETB=0V, VIO=0V
VBAT Circuit current 2	IBAT2	-	0.5	3.0	μA	RESETB=0V, VIO=1.8V
VBAT Circuit current 3	IBAT3	-	90	150	μA	LDO1=LDO2=ON, ILDO=0mA Other blocks=OFF
VBAT Circuit current 4	IBAT4	-	90	150	μA	LDO3=LDO4=ON, ILDO=0mA Other blocks=OFF
VBAT Circuit current 5	IBAT5	-	390	600	μA	LDO1=LDO2=ON, ILDO=0mA DC/DC x1mode, ILED=2.8125(30x3/32)mA x 4ch
VBAT Circuit current 6	IBAT6	-	61	65	mA	DC/DC x1mode, ILED=60mA VBAT=3.7V, LED Vf=3.0V
VBAT Circuit current 7	IBAT7	-	84	94	mA	DC/DC x1.33mode, ILED=60mA VBAT=3.1V, LED Vf=3.0V
VBAT Circuit current 8	IBAT8	-	94	104	mA	DC/DC x1.5 mode, ILED=60mA VBAT=2.9V, LED Vf=3.5V
VBAT Circuit current 9	IBAT9	-	128	136	mA	DC/DC x2 mode, ILED=60mA VBAT=2.9V, LED Vf=4.0V
【LED Driver】						
LED current Step	ILEDSTP	32			Step	LED1~7
White LED Maximum setup current	IMAXWLED	-	30	-	mA	LED1~7 (Normal mode)
Flash LED Maximum setup current	IMAXFLED	-	120	-	mA	LED5~7 (Flash mode)
White LED current accuracy	IWLED	-7%	15	+7%	mA	ILED=15mA setting (Normal mode) At VLED=1.0V
Flash LED current accuracy	IFLED	-	60	-	mA	ILED=60mA setting (Flash mode) At VLED=1.0V
LED current Matching	ILEDMT	-	-	4	%	Between LED1~7 at VLED=1.0V
Flash / Normal current ratio	RATFL	3.2	4	4.8	A/A	LED5~7, Flash mode/Normal mode At VLED=1.0V
LED OFF Leak current	ILKLED	-	-	1.0	μA	VLED=4.5V
【DC/DC(Charge Pump)】						
Maximum Output voltage	V ^o CP	4.65	5.1	5.55	V	
Current Load	IOUT	-	-	480	mA	VBAT≥3.2V, VOUT=4V
Oscillator frequency	fosc	0.72	0.9	1.08	MHz	
Over Voltage Protection detect voltage	OVP	5.0	5.5	6.0	V	
Short Circuit current limit	Ilim	-	250	500	mA	VOUT=0V
【I²C Input (SDA, SCL)】						
LOW level input voltage	VIL	-0.3	-	0.25 × VIO	V	
HIGH level input voltage	VIH	0.75 × VIO	-	VBAT +0.3	V	
Hysteresis of Schmitt trigger input	Vhys	0.05 × VIO	-	-	V	
LOW level output voltage (SDA) at 3mA sink current	VOL	0	-	0.3	V	
Input current each I/O pin	Iin	-3	-	3	μA	Input voltage = 0.1×VIO~0.9×VIO
【RESETB】						
LOW level input voltage	VIL	-0.3	-	0.25 × VIO	V	
HIGH level input voltage	VIH	0.75 × VIO	-	VBAT +0.3	V	
Input current each I/O pin	Iin	-3	-	3	μA	Input voltage = 0.1×VIO~0.9×VIO

●Electrical Characteristics (Unless otherwise specified, Ta=25°C, VBAT=3.6V, VIO=1.8V)

Parameter	Symbol	Limits			Unit	Condition
		Min.	Typ.	Max.		
【Regulator (LDO1)】						
Output voltage	Vo1	1.164	1.20	1.236	V	Io=50mA
		1.261	1.30	1.339	V	Io=50mA
		1.455	1.50	1.545	V	Io=50mA
		1.552	1.60	1.648	V	Io=50mA
		1.746	1.80	1.854	V	Io=50mA <Initial Voltage>
		2.134	2.20	2.266	V	Io=50mA
		2.328	2.40	2.472	V	Io=50mA
		2.425	2.50	2.575	V	Io=50mA
		2.522	2.60	2.678	V	Io=50mA
		2.619	2.70	2.781	V	Io=50mA
		2.716	2.80	2.884	V	Io=50mA
		2.813	2.90	2.987	V	Io=50mA
		2.910	3.00	3.090	V	Io=50mA
		3.007	3.10	3.193	V	Io=50mA
		3.104	3.20	3.296	V	Io=50mA
3.201	3.30	3.399	V	Io=50mA		
Output Current	Io1	-	-	200	mA	Vo=1.8V
Dropout Voltage	Vsat1	-	0.2	0.3	V	VBAT=2.5V, Io=200mA, Vo=2.8V
Load stability	ΔVo11	-	10	60	mV	Io=1~200mA, Vo=1.8V
Input voltage stability	ΔVo12	-	10	60	mV	VBAT=3.4~4.5V, Io=50mA, Vo=1.8V
Ripple Rejection Ratio	RR1	-	65	-	dB	f=100Hz, Vin=200mVp-p, Vo=1.2V Io=50mA, BW=20Hz~20kHz
Short circuit current limit	Ilim1	-	250	500	mA	Vo=0V
Discharge resister at OFF	ROFF1	-	1.0	1.5	kΩ	
【Regulator (LDO2)】						
Output voltage	Vo2	1.164	1.20	1.236	V	Io=50mA
		1.261	1.30	1.339	V	Io=50mA
		1.455	1.50	1.545	V	Io=50mA
		1.552	1.60	1.648	V	Io=50mA
		1.746	1.80	1.854	V	Io=50mA
		2.134	2.20	2.266	V	Io=50mA
		2.328	2.40	2.472	V	Io=50mA
		2.425	2.50	2.575	V	Io=50mA <Initial Voltage>
		2.522	2.60	2.678	V	Io=50mA
		2.619	2.70	2.781	V	Io=50mA
		2.716	2.80	2.884	V	Io=50mA
		2.813	2.90	2.987	V	Io=50mA
		2.910	3.00	3.090	V	Io=50mA
		3.007	3.10	3.193	V	Io=50mA
		3.104	3.20	3.296	V	Io=50mA
3.201	3.30	3.399	V	Io=50mA		
Output Current	Io2	-	-	200	mA	Vo=2.5V
Dropout Voltage	Vsat2	-	0.2	0.3	V	VBAT=2.5V, Io=200mA, Vo=2.8V
Load stability	ΔVo21	-	10	60	mV	Io=1~200mA, Vo=2.5V
Input voltage stability	ΔVo22	-	10	60	mV	VBAT=3.4~4.5V, Io=50mA, Vo=2.5V
Ripple Rejection Ratio	RR2	-	65	-	dB	f=100Hz, Vin=200mVp-p, Vo=1.2V Io=50mA, BW=20Hz~20kHz
Short circuit current limit	Ilim2	-	250	500	mA	Vo=0V
Discharge resister at OFF	ROFF2	-	1.0	1.5	kΩ	

●Electrical Characteristics (Unless otherwise specified, Ta=25°C, VBAT=3.6V, VIO=1.8V)

Parameter	Symbol	Limits			Unit	Condition
		Min.	Typ.	Max.		
【Regulator (LDO3)】						
Output voltage	Vo3	1.164	1.20	1.236	V	Io=50mA
		1.261	1.30	1.339	V	Io=50mA
		1.455	1.50	1.545	V	Io=50mA
		1.552	1.60	1.648	V	Io=50mA
		1.746	1.80	1.854	V	Io=50mA <Initial Voltage>
		2.134	2.20	2.266	V	Io=50mA
		2.328	2.40	2.472	V	Io=50mA
		2.425	2.50	2.575	V	Io=50mA
		2.522	2.60	2.678	V	Io=50mA
		2.619	2.70	2.781	V	Io=50mA
		2.716	2.80	2.884	V	Io=50mA
		2.813	2.90	2.987	V	Io=50mA
		2.910	3.00	3.090	V	Io=50mA
		3.007	3.10	3.193	V	Io=50mA
		3.104	3.20	3.296	V	Io=50mA
3.201	3.30	3.399	V	Io=50mA		
Output Current	Io3	-	-	150	mA	Vo=1.8V
Dropout Voltage	Vsat3	-	0.2	0.3	V	VBAT=2.5V, Io=150mA, Vo=2.8V
Load stability	Δvo31	-	10	60	mV	Io=1~150mA, Vo=1.8V
Input voltage stability	Δvo32	-	10	60	mV	VBAT=3.4~4.5V, Io=50mA, Vo=1.8V
Ripple Rejection Ratio	RR3	-	65	-	dB	f=100Hz, Vin=200mVp-p, Vo=1.2V Io=50mA, BW=20Hz~20kHz
Short circuit current limit	Ilim3	-	200	400	mA	Vo=0V
Discharge resister at OFF	ROFF3	-	1.0	1.5	kΩ	
【Regulator (LDO4)】						
Output voltage	Vo4	1.164	1.20	1.236	V	Io=50mA
		1.261	1.30	1.339	V	Io=50mA
		1.455	1.50	1.545	V	Io=50mA
		1.552	1.60	1.648	V	Io=50mA
		1.746	1.80	1.854	V	Io=50mA
		2.134	2.20	2.266	V	Io=50mA
		2.328	2.40	2.472	V	Io=50mA
		2.425	2.50	2.575	V	Io=50mA
		2.522	2.60	2.678	V	Io=50mA
		2.619	2.70	2.781	V	Io=50mA
		2.716	2.80	2.884	V	Io=50mA <Initial Voltage>
		2.813	2.90	2.987	V	Io=50mA
		2.910	3.00	3.090	V	Io=50mA
		3.007	3.10	3.193	V	Io=50mA
		3.104	3.20	3.296	V	Io=50mA
3.201	3.30	3.399	V	Io=50mA		
Output Current	Io4	-	-	150	mA	Vo=2.8V
Dropout Voltage	Vsat4	-	0.2	0.3	V	VBAT=2.5V, Io=150mA, Vo=2.8V
Load stability	Δvo41	-	10	60	mV	Io=1~150mA, Vo=2.8V
Input voltage stability	Δvo42	-	10	60	mV	VBAT=3.4~4.5V, Io=50mA, Vo=2.8V
Ripple Rejection Ratio	RR4	-	65	-	dB	f=100Hz, Vin=200mVp-p, Vo=1.2V Io=50mA, BW=20Hz~20kHz
Short circuit current limit	Ilim4	-	200	400	mA	Vo=0V
Discharge resister at OFF	ROFF4	-	1.0	1.5	kΩ	

●Block Diagram / Application Circuit example

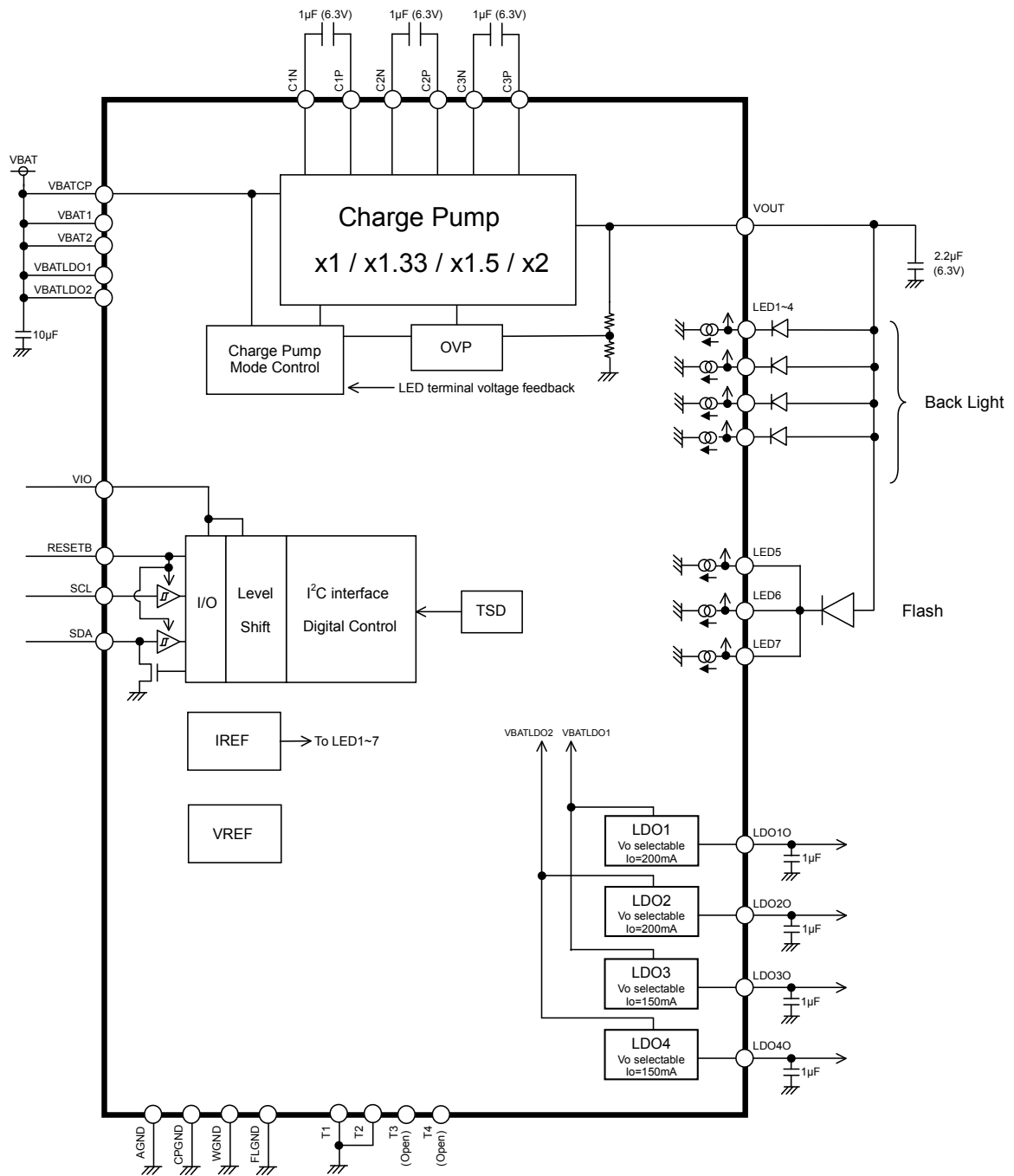

Fig.1 Block Diagram / Application Circuit example 1
Back Light (4ch) + Flash (total 360mA)

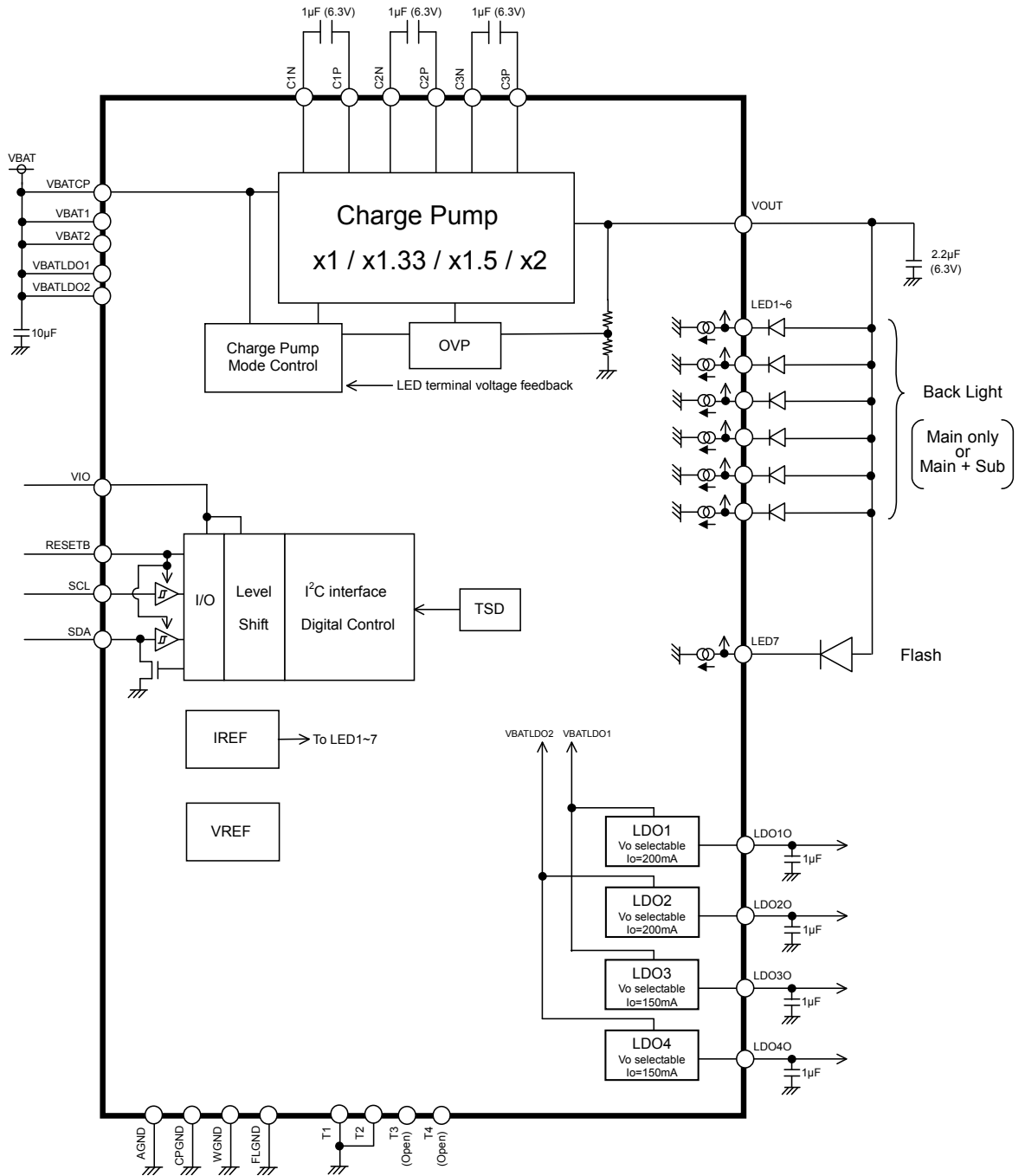
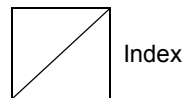

Fig.2 Block Diagram / Application Circuit example 2
Back Light (6ch) + Flash (max 120mA)

●Pin Arrangement [Bottom View]

F	T4	VBATLDO2	VBAT1	AGND	VBATLDO1	T3
E	LDO2O	LDO4O	VBAT2	LDO3O	LDO1O	VIO
D	LED6	LED7	RESETB	SCL	SDA	C1N
C	LED5	FLGND	/	CPGND	C2N	C1P
B	LED4	WGND	LED2	VOUT	C2P	VBATCP
A	T1	LED3	LED1	C3N	C3P	T2
	1	2	3	4	5	6



Total: 35balls

●Package

VCSP50L3

SIZE : 3.30mm × 3.30mm

A ball pitch : 0.5mm

Height : 0.55mm max

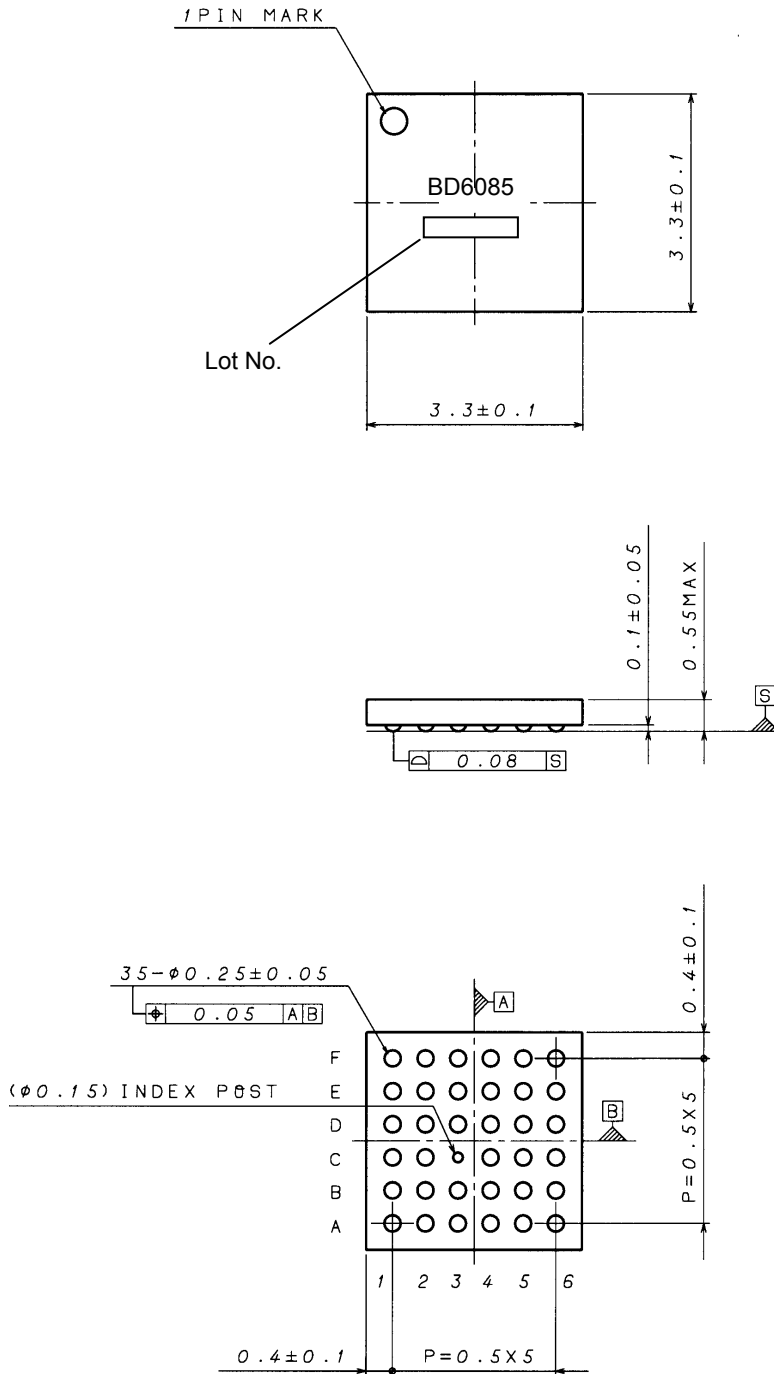

● Pin Functions

No	Ball No.	Pin Name	I/O	ESD Diode		Functions	Equivalent Circuit
				For Power	For Ground		
1	B6	VBATCP	-	-	GND	Power supply for charge pump	A
2	F3	VBAT1	-	-	GND	Power supply	A
3	E3	VBAT2	-	-	GND	Power supply	A
4	F5	VBATLDO1	-	-	GND	Power supply for LDO	A
5	F2	VBATLDO2	-	-	GND	Power supply for LDO	A
6	A1	T1	I	VBAT	GND	Test Input Pin (short to Ground)	S
7	A6	T2	I	VBAT	GND	Test Input Pin (short to Ground)	S
8	F6	T3	O	VBAT	GND	Test Output Pin (Open)	M
9	F1	T4	O	VBAT	GND	Test Output Pin (Open)	N
10	E6	VIO	-	VBAT	GND	Power supply for I/O and Digital	C
11	D3	RESETB	I	VBAT	GND	Reset input (L: reset, H: reset cancel)	H
12	D5	SDA	I/O	VBAT	GND	I ² C data input / output	I
13	D4	SCL	I	VBAT	GND	I ² C clock input	H
14	C4	CPGND	-	VBAT	-	Ground	B
15	F4	AGND	-	VBAT	-	Ground	B
16	B2	WGND	-	VBAT	-	Ground	B
17	C2	FLGND	-	VBAT	-	Ground	B
18	D6	C1N	I/O	VBAT	GND	Charge Pump capacitor is connected	F
19	C6	C1P	I/O	-	GND	Charge Pump capacitor is connected	G
20	C5	C2N	I/O	VBAT	GND	Charge Pump capacitor is connected	F
21	B5	C2P	I/O	-	GND	Charge Pump capacitor is connected	G
22	A4	C3N	I/O	VBAT	GND	Charge Pump capacitor is connected	F
23	A5	C3P	I/O	-	GND	Charge Pump capacitor is connected	G
24	B4	VOUT	O	-	GND	Charge Pump output pin	A
25	E5	LDO1O	O	VBAT	GND	LDO1 output pin	Q
26	E1	LDO2O	O	VBAT	GND	LDO2 output pin	Q
27	E4	LDO3O	O	VBAT	GND	LDO3 output pin	Q
28	E2	LDO4O	O	VBAT	GND	LDO4 output pin	Q
29	A3	LED1	I	-	GND	LED cathode connection 1 (for Back Light)	E
30	B3	LED2	I	-	GND	LED cathode connection 2 (for Back Light)	E
31	A2	LED3	I	-	GND	LED cathode connection 3 (for Back Light)	E
32	B1	LED4	I	-	GND	LED cathode connection 4 (for Back Light)	E
33	C1	LED5	I	-	GND	LED cathode connection 5 (for Back Light or Flash)	E
34	D1	LED6	I	-	GND	LED cathode connection 6 (for Back Light or Flash)	E
35	D2	LED7	I	-	GND	LED cathode connection 7 (for Back Light or Flash)	E

※The LED terminal that isn't used is to short-circuit to the ground. But, the setup of a register concerned with LED that isn't used is prohibited.

Total: 35Pin

●Equivalent Circuit

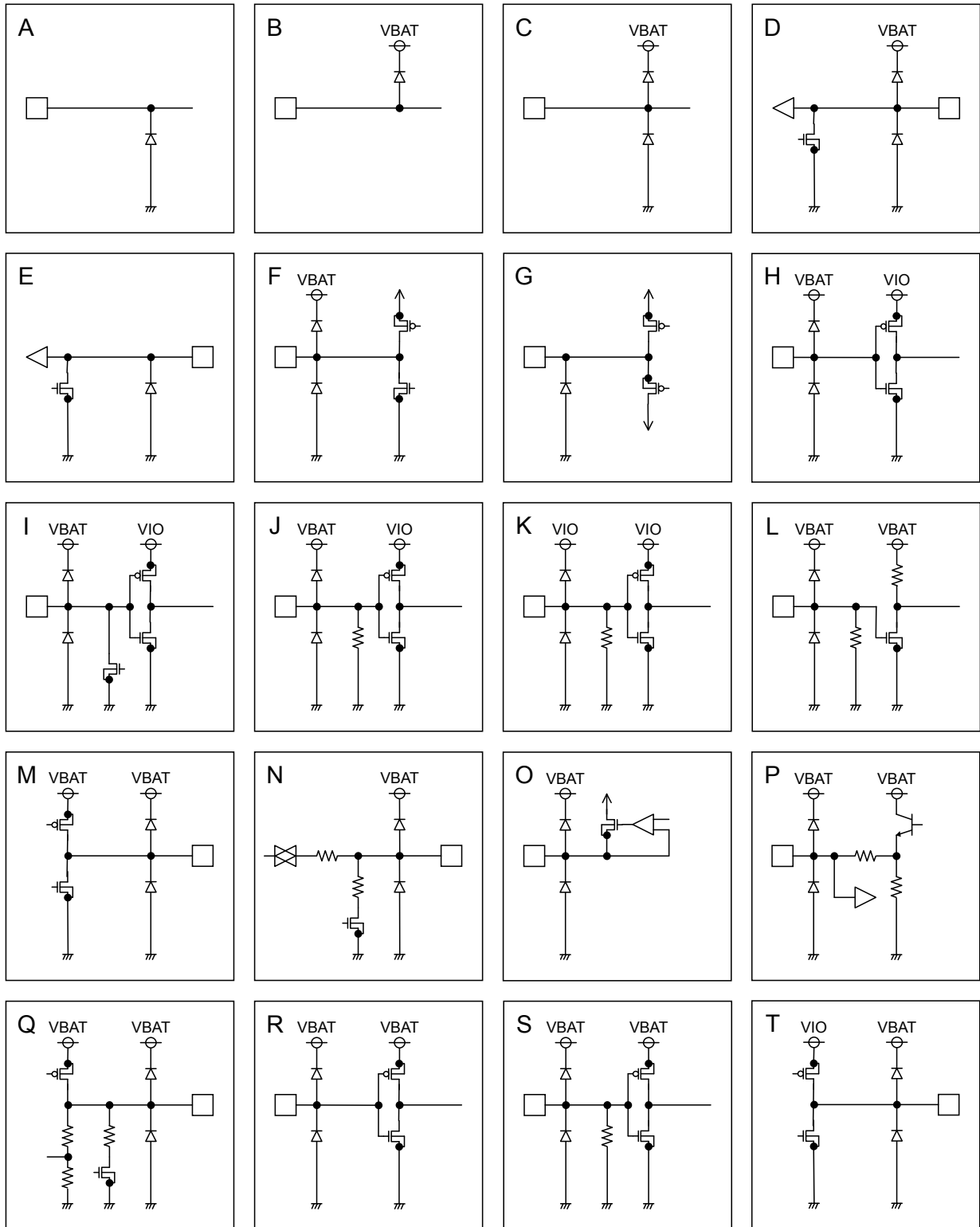

● I²C BUS format

The writing/reading operation is based on the I²C slave standard.

• Slave address

A7	A6	A5	A4	A3	A2	A1	R/W
1	1	1	0	1	1	0	1/0

• Bit Transfer

SCL transfers 1-bit data during H. SCL cannot change signal of SDA during H at the time of bit transfer. If SDA changes while SCL is H, START conditions or STOP conditions will occur and it will be interpreted as a control signal.

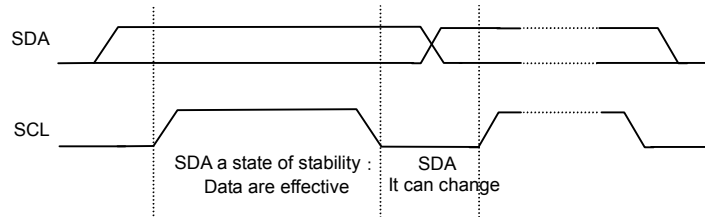

• START and STOP condition

When SDA and SCL are H, data is not transferred on the I²C- bus. This condition indicates, if SDA changes from H to L while SCL has been H, it will become START (S) conditions, and an access start, if SDA changes from L to H while SCL has been H, it will become STOP (P) conditions and an access end.

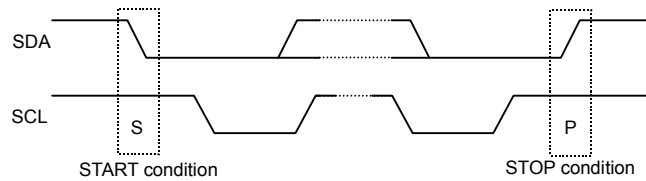

• Acknowledge

It transfers data 8 bits each after the occurrence of START condition. A transmitter opens SDA after transfer 8bits data, and a receiver returns the acknowledge signal by setting SDA to L.

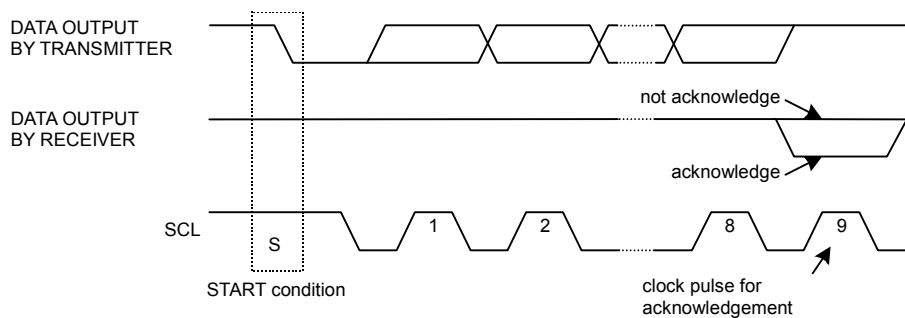

• Writing protocol

A register address is transferred by the next 1 byte that transferred the slave address and the write-in command. The 3rd byte writes data in the internal register written in by the 2nd byte, and after 4th byte or, the increment of register address is carried out automatically. However, when a register address turns into the last address, it is set to 00h by the next transmission. After the transmission end, the increment of the address is carried out.

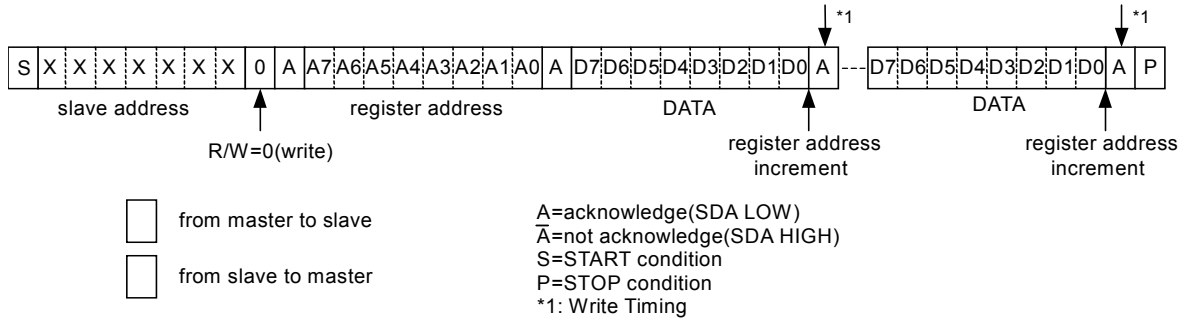

• Reading protocol

It reads from the next byte after writing a slave address and R/W bit. The register to read considers as the following address accessed at the end, and the data of the address that carried out the increment is read after it. If an address turns into the last address, the next byte will read out 00h. After the transmission end, the increment of the address is carried out.

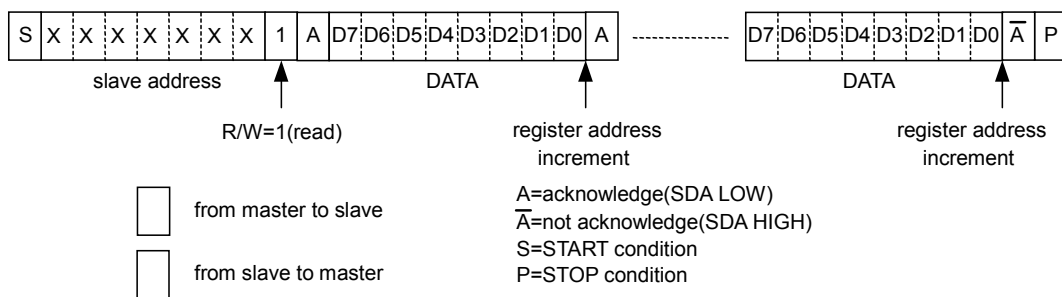

• Multiple reading protocols

After specifying an internal address, it reads by repeated START condition and changing the data transfer direction. The data of the address that carried out the increment is read after it. If an address turns into the last address, the next byte will read out 00h. After the transmission end, the increment of the address is carried out.

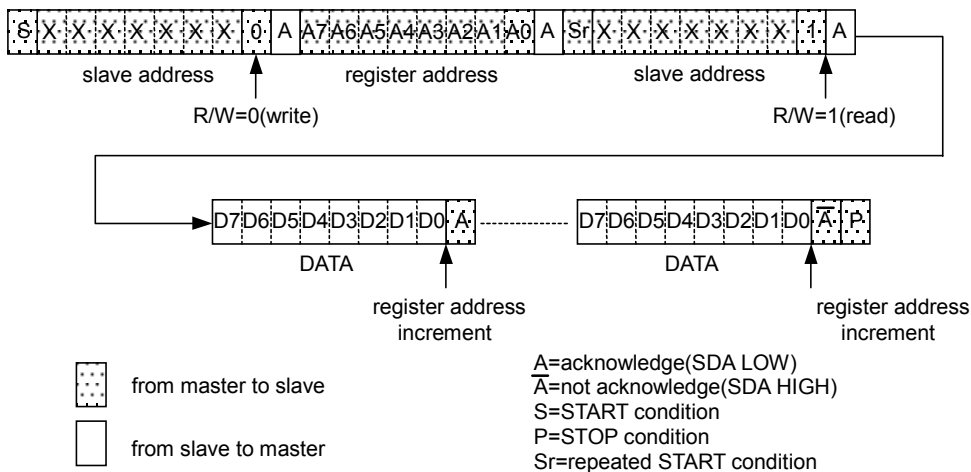

As for reading protocol and multiple reading protocols, please do A-bar (not acknowledge) after doing the final reading operation. It stops with read when ending by A (acknowledge), and SDA stops in the state of Low when the reading data of that time is 0. However, this state returns usually when SCL is moved, data is read, and A-bar (not acknowledge) is done.

●Timing diagram

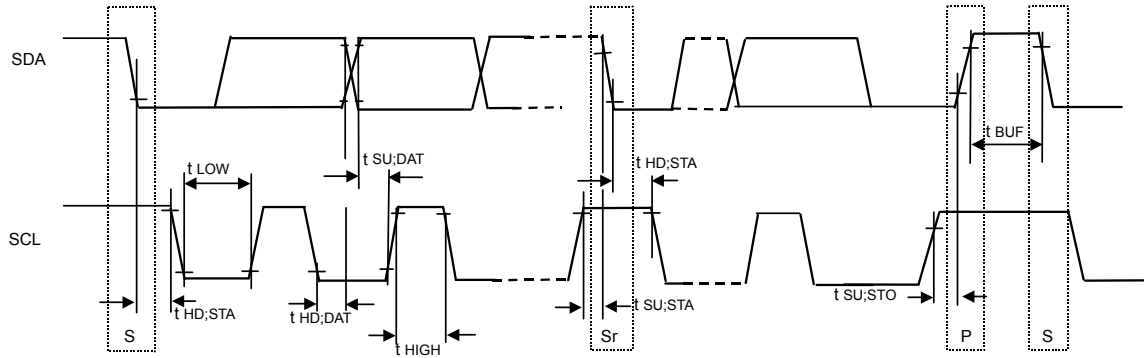

●Electrical Characteristics(Unless otherwise specified, Ta=25 °C, VBAT=3.6V, VIO=1.8V)

Parameter	Symbol	Standard-mode			Fast-mode			Unit
		Min.	Typ.	Max.	Min.	Typ.	Max.	
[I²C BUS format]								
SCL clock frequency	fSCL	0	-	100	0	-	400	kHz
LOW period of the SCL clock	tLOW	4.7	-	-	1.3	-	-	µs
HIGH period of the SCL clock	tHIGH	4.0	-	-	0.6	-	-	µs
Hold time (repeated) START condition After this period, the first clock is generated	tHD:STA	4.0	-	-	0.6	-	-	µs
Set-up time for a repeated START condition	tSU:STA	4.7	-	-	0.6	-	-	µs
Data hold time	tHD:DAT	0	-	3.45	0	-	0.9	µs
Data set-up time	tSU:DAT	250	-	-	100	-	-	ns
Set-up time for STOP condition	tSU:STO	4.0	-	-	0.6	-	-	µs
Bus free time between a STOP and START condition	tBUF	4.7	-	-	1.3	-	-	µs

● Register List

Address	Register data								Function
	D7	D6	D5	D4	D3	D2	D1	D0	
00h	-	GRPSET2	GRPSET1	GRPSET0	-	-	-	SFTRST	Software Reset LED Lighting group Setting
01h	-	LDO4EN	LDO3EN	LDO2EN	LDO1EN	FLLEDEN	SLEDEN	MLEDEN	Enable Control
02h	-	-	-	IMLED4	IMLED3	IMLED2	IMLED1	IMLED0	Main LED Current Setting
03h	-	-	-	ISLED4	ISLED3	ISLED2	ISLED1	ISLED0	Sub LED Current Setting
04h	-	-	FLASHEN	IFLLED4	IFLLED3	IFLLED2	IFLLED1	IFLLED0	Flash LED Current Setting Flash mode Setting
05h	LDO2VSEL3	LDO2VSEL2	LDO2VSEL1	LDO2VSEL0	LDO1VSEL3	LDO1VSEL2	LDO1VSEL1	LDO1VSEL0	LDO1 Vout Control LDO2 Vout Control
06h	LDO4VSEL3	LDO4VSEL2	LDO4VSEL1	LDO4VSEL0	LDO3VSEL3	LDO3VSEL2	LDO3VSEL1	LDO3VSEL0	LDO3 Vout Control LDO4 Vout Control

Input "0" for "-".

Prohibit to accessing the address that isn't mentioned.

● Register Map

Address 00h < Software Reset, LED Lighting group Setting >

Address	R/W	Bit7	Bit6	Bit5	Bit4	Bit3	Bit2	Bit1	Bit0
00h	R/W	-	GRPSET2	GRPSET1	GRPSET0	-	-	-	SFTRST
Initial Value	00h	-	0	0	0	-	-	-	0

Bit7 : (Not used)

Bit [6:4] : GRPSET [2:0]

	(Main group)	(Sub group)	(Flash group)
"000" :	LED1~4	---	LED5~7
"001" :	LED1~4	LED5	LED6~7
"010" :	LED1~4	LED5~6	LED7
"011" :	LED1~4	LED5	LED7
"100" :	LED1~5	LED6	LED7
"101" :	LED1~5	---	LED6~7
"110" :	LED1~6	---	LED7
"111" :	LED1~6	---	LED7

Bit [3:1] : (Not used)

Bit0 : SFTRST

"0" : Reset cancel

"1" : Reset (All register initializing)

Address 01h < Enable Control >

Address	R/W	Bit7	Bit6	Bit5	Bit4	Bit3	Bit2	Bit1	Bit0
01h	R/W	-	LDO4EN	LDO3EN	LDO2EN	LDO1EN	FLLEDEN	SLEDEN	MLEDEN
Initial Value	00h	-	0	0	0	0	0	0	0

Bit7 : (Not used)

Bit6 : LDO4EN
 "0" : LDO4 OFF
 "1" : LDO4 ON

Bit5 : LDO3EN
 "0" : LDO3 OFF
 "1" : LDO3 ON

Bit4 : LDO2EN
 "0" : LDO2 OFF
 "1" : LDO2 ON

Bit3 : LDO1EN
 "0" : LDO1 OFF
 "1" : LDO1 ON

Bit2 : FLLEDEN
 "0" : Flash LED OFF
 "1" : Flash LED ON

Bit1 : SLEDEN
 "0" : Sub LED OFF
 "1" : Sub LED ON

Bit0 : MLEDEN
 "0" : Main LED OFF
 "1" : Main LED ON

Address 02h < Main LED Current Setting >

Address	R/W	Bit7	Bit6	Bit5	Bit4	Bit3	Bit2	Bit1	Bit0
02h	R/W	-	-	-	IMLED4	IMLED3	IMLED2	IMLED1	IMLED0
Initial Value	00h	-	-	-	0	0	0	0	0

Bit[7:5] : (Not used)

Bit[4:0] : IMLED [4:0]

"00000"	0.9375 mA	(Initial value)
"00001"	1.875 mA	
"00010"	2.8125 mA	
"00011"	3.75 mA	
"00100"	4.6875 mA	
"00101"	5.625 mA	
"00110"	6.5625 mA	
"00111"	7.5 mA	
"01000"	8.4375 mA	
"01001"	9.375 mA	
"01010"	10.3125 mA	
"01011"	11.25 mA	
"01100"	12.1875 mA	
"01101"	13.125 mA	
"01110"	14.0625 mA	
"01111"	15 mA	
"10000"	15.9375 mA	
"10001"	16.875 mA	
"10010"	17.8125 mA	
"10011"	18.75 mA	
"10100"	19.6875 mA	
"10101"	20.625 mA	
"10110"	21.5625 mA	
"10111"	22.5 mA	
"11000"	23.4375 mA	
"11001"	24.375 mA	
"11010"	25.3125 mA	
"11011"	26.25 mA	
"11100"	27.1875 mA	
"11101"	28.125 mA	
"11110"	29.0625 mA	
"11111"	30 mA	

* LED Current : 30 x 1/32 mA Step

Address 03h < Sub LED Current Setting >

Address	R/W	Bit7	Bit6	Bit5	Bit4	Bit3	Bit2	Bit1	Bit0
03h	R/W	-	-	-	ISLED4	ISLED3	ISLED2	ISLED1	ISLED0
Initial Value	00h	-	-	-	0	0	0	0	0

Bit[7:5] : (Not used)

Bit[4:0] : ISLED [4:0]

"00000"	0.9375 mA	(Initial value)
"00001"	1.875 mA	
"00010"	2.8125 mA	
"00011"	3.75 mA	
"00100"	4.6875 mA	
"00101"	5.625 mA	
"00110"	6.5625 mA	
"00111"	7.5 mA	
"01000"	8.4375 mA	
"01001"	9.375 mA	
"01010"	10.3125 mA	
"01011"	11.25 mA	
"01100"	12.1875 mA	
"01101"	13.125 mA	
"01110"	14.0625 mA	
"01111"	15 mA	
"10000"	15.9375 mA	
"10001"	16.875 mA	
"10010"	17.8125 mA	
"10011"	18.75 mA	
"10100"	19.6875 mA	
"10101"	20.625 mA	
"10110"	21.5625 mA	
"10111"	22.5 mA	
"11000"	23.4375 mA	
"11001"	24.375 mA	
"11010"	25.3125 mA	
"11011"	26.25 mA	
"11100"	27.1875 mA	
"11101"	28.125 mA	
"11110"	29.0625 mA	
"11111"	30 mA	

* LED Current : 30 x 1/32 mA Step

Address 04h < Flash LED Current Setting, Flash mode Setting >

Address	R/W	Bit7	Bit6	Bit5	Bit4	Bit3	Bit2	Bit1	Bit0
04h	R/W	-	-	FLASHEN	IFLLED4	IFLLED3	IFLLED2	IFLLED1	IFLLED0
Initial Value	00h	-	-	0	0	0	0	0	0

Bit[7:6] : (Not used)

Bit5 : FLASHEN

“0” : Flash mode OFF

“1” : Flash mode ON (x4 normal mode)

Bit[4:0] : IFLLED [4:0]

	(At FLASHEN=0)	(At FLASHEN=1)	(Initial value)
“0000”	0.9375 mA,	3.75 mA	
“00001”	1.875 mA,	7.5 mA	
“00010”	2.8125 mA,	11.25 mA	
“00011”	3.75 mA,	15 mA	
“00100”	4.6875 mA,	18.75 mA	
“00101”	5.625 mA,	22.5 mA	
“00110”	6.5625 mA,	26.25 mA	
“00111”	7.5 mA,	30 mA	
“01000”	8.4375 mA,	33.75 mA	
“01001”	9.375 mA,	37.5 mA	
“01010”	10.3125 mA,	41.25 mA	
“01011”	11.25 mA,	45 mA	
“01100”	12.1875 mA,	48.75 mA	
“01101”	13.125 mA,	52.5 mA	
“01110”	14.0625 mA,	56.25 mA	
“01111”	15 mA,	60 mA	
“10000”	15.9375 mA,	63.75 mA	
“10001”	16.875 mA,	67.5 mA	
“10010”	17.8125 mA,	71.25 mA	
“10011”	18.75 mA,	75 mA	
“10100”	19.6875 mA,	78.75 mA	
“10101”	20.625 mA,	82.5 mA	
“10110”	21.5625 mA,	86.25 mA	
“10111”	22.5 mA,	90 mA	
“11000”	23.4375 mA,	93.75 mA	
“11001”	24.375 mA,	97.5 mA	
“11010”	25.3125 mA,	101.25 mA	
“11011”	26.25 mA,	105 mA	
“11100”	27.1875 mA,	108.75 mA	
“11101”	28.125 mA,	112.5 mA	
“11110”	29.0625 mA,	116.25 mA	
“11111”	30 mA,	120 mA	

* LED Current : 30 x 1/32 mA Step (at FLASHEN=0), 120 x 1/32 mA Step (at FLASHEN=1)

Address 05h < LDO1 Vout Control, LDO2 Vout Control >

Address	R/W	Bit7	Bit6	Bit5	Bit4	Bit3	Bit2	Bit1	Bit0
05h	R/W	LDO2VSEL3	LDO2VSEL2	LDO2VSEL1	LDO2VSEL0	LDO1VSEL3	LDO1VSEL2	LDO1VSEL1	LDO1VSEL0
Initial Value	74h	0	1	1	1	0	1	0	0

Bit[7:4] : LDO2VSEL [3:0]

"0000" : 1.20 V
 "0001" : 1.30 V
 "0010" : 1.50 V
 "0011" : 1.60 V
 "0100" : 1.80 V
 "0101" : 2.20 V
 "0110" : 2.40 V
 "0111" : 2.50 V (Initial value)
 "1000" : 2.60 V
 "1001" : 2.70 V
 "1010" : 2.80 V
 "1011" : 2.90 V
 "1100" : 3.00 V
 "1101" : 3.10 V
 "1110" : 3.20 V
 "1111" : 3.30 V

Bit[3:0] : LDO1VSEL [3:0]

"0000" : 1.20 V
 "0001" : 1.30 V
 "0010" : 1.50 V
 "0011" : 1.60 V
 "0100" : 1.80 V (Initial value)
 "0101" : 2.20 V
 "0110" : 2.40 V
 "0111" : 2.50 V
 "1000" : 2.60 V
 "1001" : 2.70 V
 "1010" : 2.80 V
 "1011" : 2.90 V
 "1100" : 3.00 V
 "1101" : 3.10 V
 "1110" : 3.20 V
 "1111" : 3.30 V

Address 06h < LDO3 Vout Control, LDO4 Vout Control >

Address	R/W	Bit7	Bit6	Bit5	Bit4	Bit3	Bit2	Bit1	Bit0
06h	R/W	LDO4VSEL3	LDO4VSEL2	LDO4VSEL1	LDO4VSEL0	LDO3VSEL3	LDO3VSEL2	LDO3VSEL1	LDO3VSEL0
Initial Value	A4h	1	0	1	0	0	1	0	0

Bit[7:4] : LDO4VSEL [3:0]

"0000" : 1.20 V
 "0001" : 1.30 V
 "0010" : 1.50 V
 "0011" : 1.60 V
 "0100" : 1.80 V
 "0101" : 2.20 V
 "0110" : 2.40 V
 "0111" : 2.50 V
 "1000" : 2.60 V
 "1001" : 2.70 V
 "1010" : 2.80 V (Initial value)
 "1011" : 2.90 V
 "1100" : 3.00 V
 "1101" : 3.10 V
 "1110" : 3.20 V
 "1111" : 3.30 V

Bit[3:0] : LDO3VSEL [3:0]

"0000" : 1.20 V
 "0001" : 1.30 V
 "0010" : 1.50 V
 "0011" : 1.60 V
 "0100" : 1.80 V (Initial value)
 "0101" : 2.20 V
 "0110" : 2.40 V
 "0111" : 2.50 V
 "1000" : 2.60 V
 "1001" : 2.70 V
 "1010" : 2.80 V
 "1011" : 2.90 V
 "1100" : 3.00 V
 "1101" : 3.10 V
 "1110" : 3.20 V
 "1111" : 3.30 V

●Explanation for operate

1. Reset

There are two kinds of reset, software reset and hardware reset.

(1) Software reset

- All the registers are initialized more than making a register (SFTRST) setup "1".
- The register of software resetting is an automatic return (Auto Return 0).

(2) Hardware reset

- It shifts to hardware reset by changing RESETB pin "H" → "L".
- The condition of all the registers under hardware reset pin is returned to the initial value, and it stops accepting all address.
- It's possible to release from a state of hardware reset by changing RESETB pin "L" → "H".
- RESETB pin has delay circuit. It doesn't recognize as hardware reset in "L" period under 5μs.

(3) Reset Sequence

- When hardware reset was done during software reset, software reset is canceled when hardware reset is canceled. (Because the initial value of software reset is "0")

2. Thermal shutdown

The blocks which thermal shutdown function is effective in the following.

Charge pump
LED Driver
LDO1, LDO2, LDO3, LDO4

A thermal shutdown function works in about 190°C.

Detection temperature has a hysteresis, and detection release temperature is about 170°C.

(Design reference value)

3. Charge Pump for LED driver

Charge Pump block is designed for the power supply for LED driver.

It has the x1.0/x1.33/x1.5/x2.0 mode. it changes to the most suitable mode automatically by Vf of LED and the battery voltage. It has the mode of x1.33 and it can be higher efficiency than traditional.

Start

Charge Pump circuit operates when any LED turns ON.

Soft start

When the start of the Charge Pump circuit is done, it has the soft start function to prevent a rush current.

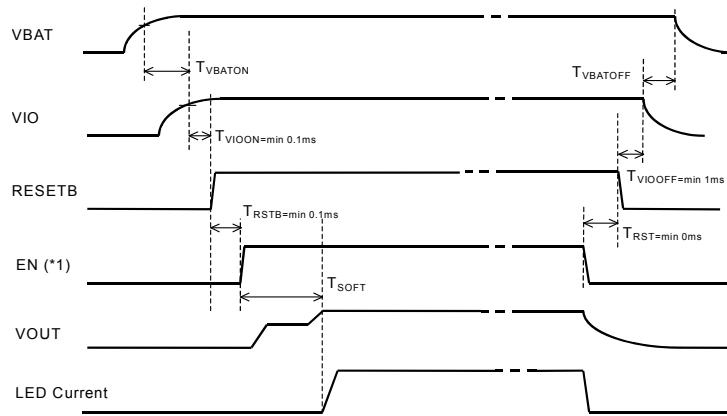

(*1) An EN signal in the upper figure means the following;

"EN is high" = Any LED turns ON

But if $T_a > T_{SD}$, EN Signal doesn't become effective.

Charge Pump Mode transition

The transition of boost multiple transits automatically by Vf of LED and the battery voltage.

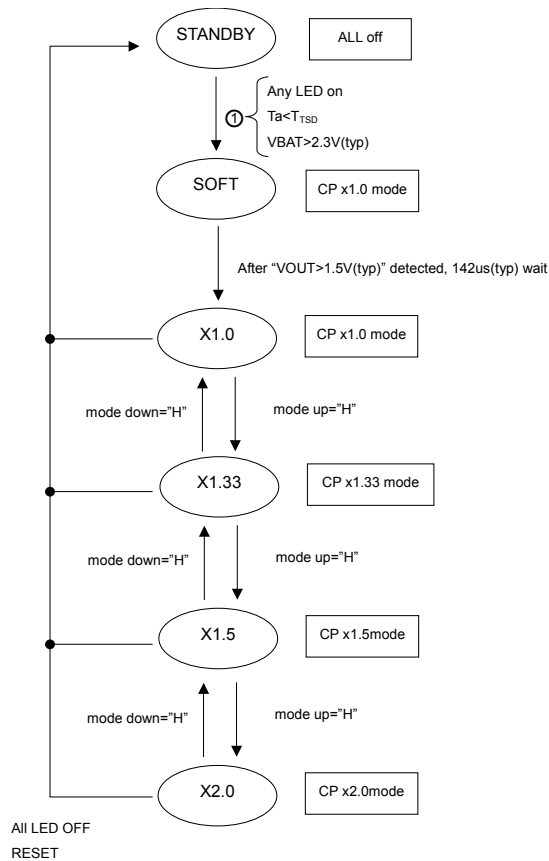

BD6085GUL changes the four charge pump movement mode automatically to realize low consumption power.

< Mode Up >

A LED terminal voltage is monitored, and the movement mode is changed to $\times 1 \rightarrow \times 1.33$, $\times 1.33 \rightarrow \times 1.5$ and $\times 1.5 \rightarrow \times 2$ automatically when a LED terminal voltage is lower than 0.2V (typ).

At this time, the maximum output voltage of the charge pump is restricted to 5.1V (typ).

< Mode Down >

The rise in the battery voltage, the off control of LED lighting and the data writing to the address 02h,03h,04h (LED Current Setting) is monitored, and the movement mode is changed to $\times 2 \rightarrow \times 1.5 \rightarrow \times 1.33 \rightarrow \times 1$ automatically at FLASHEN (Address 04h) = "0". This mode down movement lasts until a mode up movement happens. At FLASHEN = "1", the mode down doesn't happen.

The thresholds of rise in a battery voltage are 2.9V, 3.3V, 3.7V and 4.1V (typ).

And, as for the off control of LED lighting, it is shown that MLEDEN, SLEDEN and FLLEDEN (Address 01h) and FLASHEN (Address 04h) transited in "1" \rightarrow "0".

Over Voltage protection / Over Current protection

Charge Pump circuit output (VOUT) is equipped with the over-voltage protection and the over current protection function. A VOUT over-voltage detection voltage is about 5.5V (typ). (VOUT at the time of rise in a voltage)

A detection voltage has a hysteresis, and a detection release voltage is about 5.1V (typ).

And, when VOUT output short to ground, input current of the battery terminal is limited by an over current protection function.

4. LED Driver

LED current value setting (for Main/Sub)

Internal circuit fixes maximum current value of LED.
LED current is maximum 30mA/ch.

LED current value setting (for Flash)

Internal circuit fixes maximum current value of LED.

When FLASHEN (Address 04h)=0, LED current is maximum 30mA/ch. (Normal mode)

When FLASHEN (Address 04h)=1, LED current change to x4 of Normal mode. (Flash mode)

At Normal mode, it can use for LCD Backlight or Torch mode of Flash.

At Flash mode, it can use for LED Flash.

The number of LED Lighting

The number of lighting for Main/Sub/Flash LED can be set up grouping by the register GRPSET* (Address 00h).

The setting of the number of lighting is as the following.

The grouping of LED (Main/Sub/Flash) is independently controlled by register MLEDEN, SLEDEN, FLLEDEN (Address 01h).

Grouping setting	LED1	LED2	LED3	LED4	LED5	LED6	LED7	Main/Sub/Flash
(0,0,0)	Main	Main	Main	Main	Flash	Flash	Flash	4 / 0 / 3
(0,0,1)	Main	Main	Main	Main	Sub	Flash	Flash	4 / 1 / 2
(0,1,0)	Main	Main	Main	Main	Sub	Sub	Flash	4 / 2 / 1
(0,1,1)	Main	Main	Main	Main	Sub	-	Flash	4 / 1 / 1
(1,0,0)	Main	Main	Main	Main	Main	Sub	Flash	5 / 1 / 1
(1,0,1)	Main	Main	Main	Main	Main	Flash	Flash	5 / 0 / 2
(1,1,0)	Main	Main	Main	Main	Main	Main	Flash	6 / 0 / 1
(1,1,1)	Main	Main	Main	Main	Main	Main	Flash	6 / 0 / 1

Grouping setting (*,*,*) means ("GRPSET2","GRPSET1","GRPSET0").

The change of the Grouping setting with turning it on is prohibited.
The LED terminal that isn't used must be connected to the ground.

Normal mode/Flash mode

Normal mode and Flash mode change as the figure of the follow.

I_{LED} is set by the register.

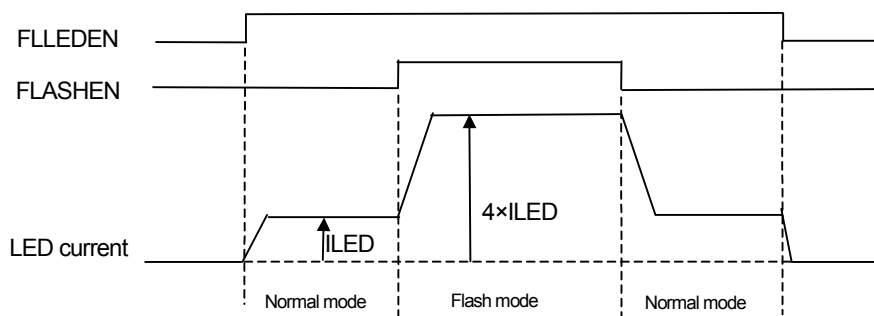

5. I/O

When the RESETB pin is Low, the input buffers (SDA and SCL) are disabled for the Low consumption power.

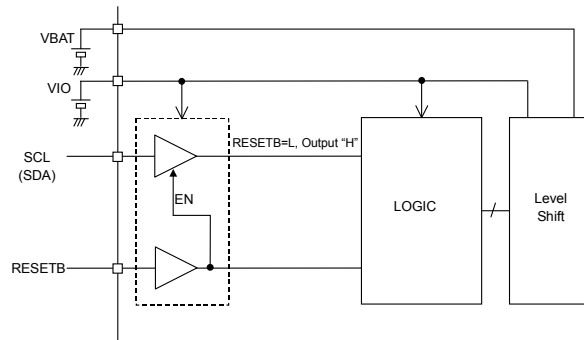

6. About the start of LDO1~LDO4

It must start as follows.

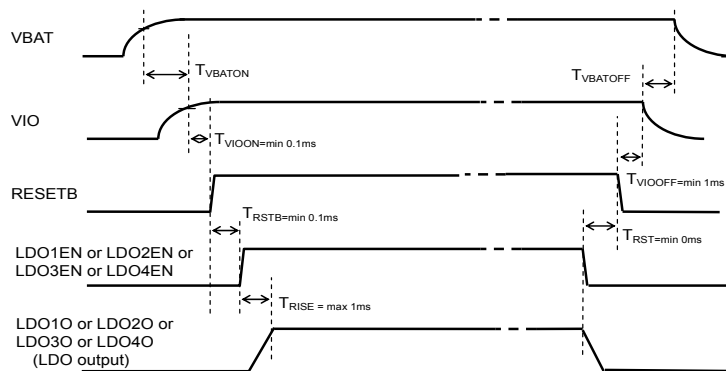

<Start Sequence>

VBAT ON (Enough rise up) → VIO ON (Enough rise up) → Reset release → LDO ON
(Register access acceptable)

<End Sequence>

LDO OFF → Reset → VIO OFF (Enough fall down) → VBAT OFF

7. About the terminal management of the function that isn't used

Set up the terminal that isn't used as follows.

The LED terminal which isn't used : Short to ground

Don't do the control concerned with this terminal.

T1, T2 : Short to ground

T3, T4 : Open

●PCB pattern of the Power dissipation measuring board

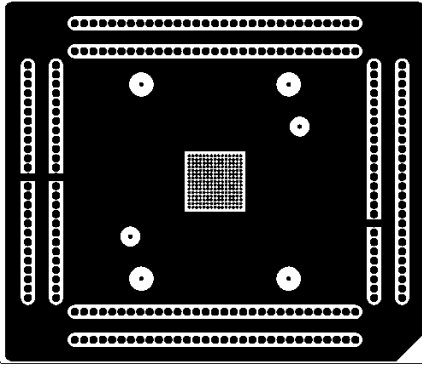

1st layer(component)

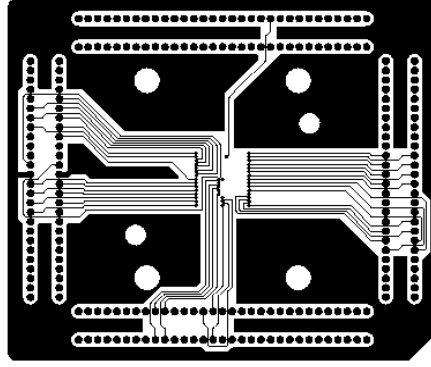

2nd layer

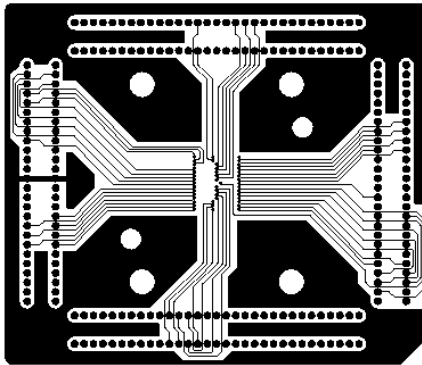

3rd layer

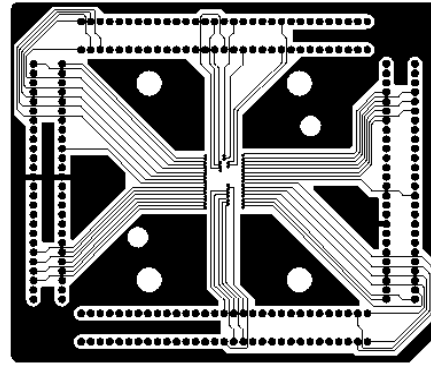

4th layer

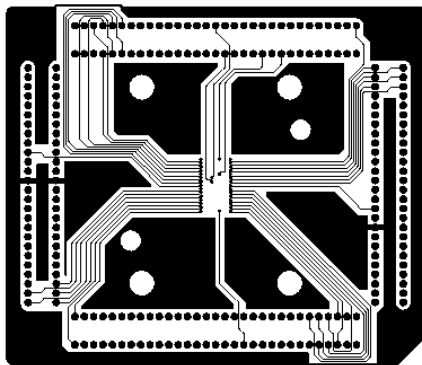

5th layer

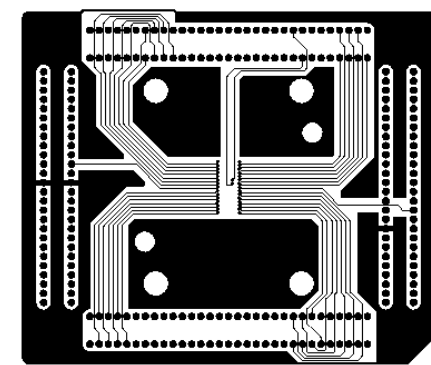

6th layer

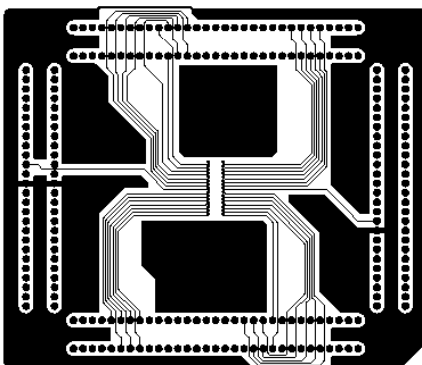

7th layer

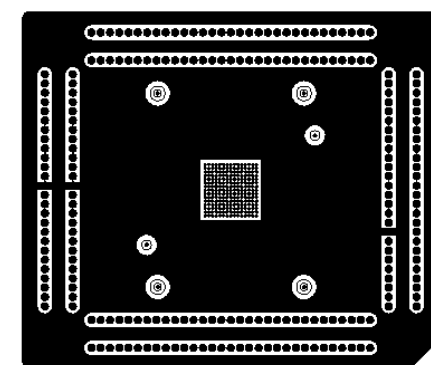

8th layer(solder)

●Cautions on use

- (1) Absolute Maximum Ratings
An excess in the absolute maximum ratings, such as supply voltage, temperature range of operating conditions, etc., can break down devices, thus making impossible to identify breaking mode such as a short circuit or an open circuit. If any special mode exceeding the absolute maximum ratings is assumed, consideration should be given to take physical safety measures including the use of fuses, etc.
- (2) Power supply and ground line
Design PCB pattern to provide low impedance for the wiring between the power supply and the ground lines. Pay attention to the interference by common impedance of layout pattern when there are plural power supplies and ground lines. Especially, when there are ground pattern for small signal and ground pattern for large current included the external circuits, please separate each ground pattern. Furthermore, for all power supply pins to ICs, mount a capacitor between the power supply and the ground pin. At the same time, in order to use a capacitor, thoroughly check to be sure the characteristics of the capacitor to be used present no problem including the occurrence of capacity dropout at a low temperature, thus determining the constant.
- (3) Ground voltage
Make setting of the potential of the ground pin so that it will be maintained at the minimum in any operating state. Furthermore, check to be sure no pins are at a potential lower than the ground voltage including an actual electric transient.
- (4) Short circuit between pins and erroneous mounting
In order to mount ICs on a set PCB, pay thorough attention to the direction and offset of the ICs. Erroneous mounting can break down the ICs. Furthermore, if a short circuit occurs due to foreign matters entering between pins or between the pin and the power supply or the ground pin, the ICs can break down.
- (5) Operation in strong electromagnetic field
Be noted that using ICs in the strong electromagnetic field can malfunction them.
- (6) Input pins
In terms of the construction of IC, parasitic elements are inevitably formed in relation to potential. The operation of the parasitic element can cause interference with circuit operation, thus resulting in a malfunction and then breakdown of the input pin. Therefore, pay thorough attention not to handle the input pins, such as to apply to the input pins a voltage lower than the ground respectively, so that any parasitic element will operate. Furthermore, do not apply a voltage to the input pins when no power supply voltage is applied to the IC. In addition, even if the power supply voltage is applied, apply to the input pins a voltage lower than the power supply voltage or within the guaranteed value of electrical characteristics.
- (7) External capacitor
In order to use a ceramic capacitor as the external capacitor, determine the constant with consideration given to a degradation in the nominal capacitance due to DC bias and changes in the capacitance due to temperature, etc.
- (8) Thermal shutdown circuit (TSD)
This LSI builds in a thermal shutdown (TSD)circuit. When junction temperatures become detection temperature or higher, the thermal shutdown circuit operates and turns a switch OFF. The thermal shutdown circuit, which is aimed at isolating the LSI from thermal runaway as much as possible, is not aimed at the protection or guarantee of the LSI. Therefore, do not continuously use the LSI with this circuit operating or use the LSI assuming its operation.
- (9) Thermal design
Perform thermal design in which there are adequate margins by taking into account the permissible dissipation (Pd)in actual states of use.
- (10) LDO
Use each output of LDO by the independence. Don't use under the condition that each output is short-circuited because it has the possibility that an operation becomes unstable.
- (11) About the pin for the test, the un-use pin
Prevent a problem from being in the pin for the test and the un-use pin under the state of actual use. Please refer to a function manual and an application notebook. And, as for the pin that doesn't specially have an explanation, ask our company person in charge.
- (12) About the rush current
For ICs with more than one power supply, it is possible that rush current may flow instantaneously due to the internal powering sequence and delays. Therefore, give special consideration to power coupling capacitance, power wiring, width of ground wiring, and routing of wiring.
- (13) About the function description or application note or more.
The function description and the application notebook are the design materials to design a set. So, the contents of the materials aren't always guaranteed. Please design application by having fully examination and evaluation include the external elements.

● Power dissipation (On the ROHM's standard board)

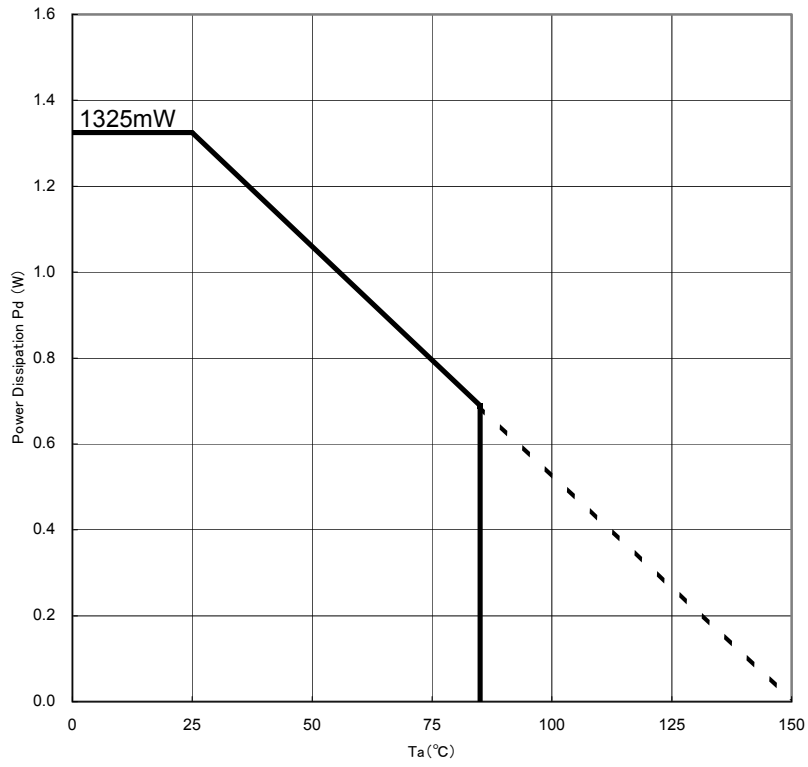

Information of the ROHM's standard board
 Material : glass-epoxy
 Size : Refer to after page.

●Ordering part number

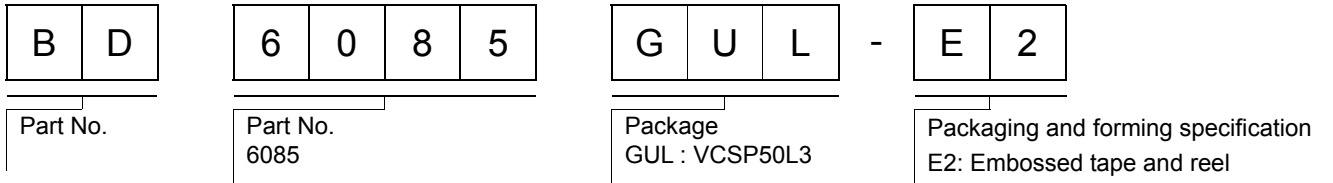

VCSP50L3(BD6085GUL)

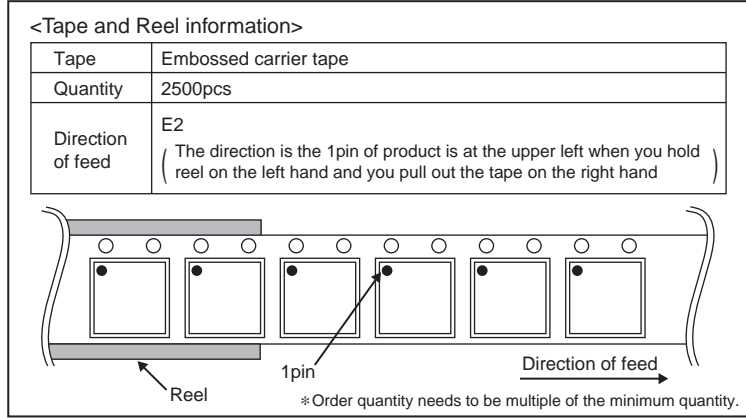
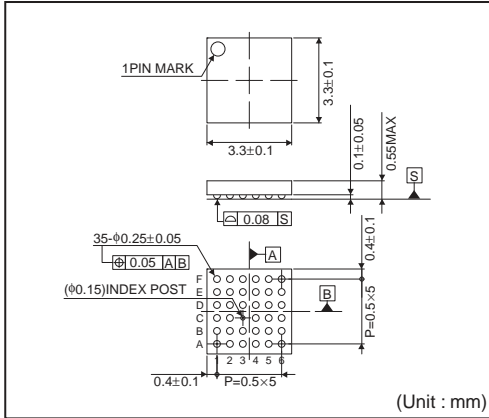

Notes

No copying or reproduction of this document, in part or in whole, is permitted without the consent of ROHM Co.,Ltd.

The content specified herein is subject to change for improvement without notice.

The content specified herein is for the purpose of introducing ROHM's products (hereinafter "Products"). If you wish to use any such Product, please be sure to refer to the specifications, which can be obtained from ROHM upon request.

Examples of application circuits, circuit constants and any other information contained herein illustrate the standard usage and operations of the Products. The peripheral conditions must be taken into account when designing circuits for mass production.

Great care was taken in ensuring the accuracy of the information specified in this document. However, should you incur any damage arising from any inaccuracy or misprint of such information, ROHM shall bear no responsibility for such damage.

The technical information specified herein is intended only to show the typical functions of and examples of application circuits for the Products. ROHM does not grant you, explicitly or implicitly, any license to use or exercise intellectual property or other rights held by ROHM and other parties. ROHM shall bear no responsibility whatsoever for any dispute arising from the use of such technical information.

The Products specified in this document are intended to be used with general-use electronic equipment or devices (such as audio visual equipment, office-automation equipment, communication devices, electronic appliances and amusement devices).

The Products specified in this document are not designed to be radiation tolerant.

While ROHM always makes efforts to enhance the quality and reliability of its Products, a Product may fail or malfunction for a variety of reasons.

Please be sure to implement in your equipment using the Products safety measures to guard against the possibility of physical injury, fire or any other damage caused in the event of the failure of any Product, such as derating, redundancy, fire control and fail-safe designs. ROHM shall bear no responsibility whatsoever for your use of any Product outside of the prescribed scope or not in accordance with the instruction manual.

The Products are not designed or manufactured to be used with any equipment, device or system which requires an extremely high level of reliability the failure or malfunction of which may result in a direct threat to human life or create a risk of human injury (such as a medical instrument, transportation equipment, aerospace machinery, nuclear-reactor controller, fuel-controller or other safety device). ROHM shall bear no responsibility in any way for use of any of the Products for the above special purposes. If a Product is intended to be used for any such special purpose, please contact a ROHM sales representative before purchasing.

If you intend to export or ship overseas any Product or technology specified herein that may be controlled under the Foreign Exchange and the Foreign Trade Law, you will be required to obtain a license or permit under the Law.



Thank you for your accessing to ROHM product informations.
More detail product informations and catalogs are available, please contact us.

ROHM Customer Support System

<http://www.rohm.com/contact/>

