

TPS563219EVM-663 3-A, Regulator Evaluation Module

This user's guide contains information for the TPS563219 as well as support documentation for the TPS563219EVM-663 evaluation module. Included are the performance specifications, schematic, and the bill of materials of the TPS563219EVM-663.

Contents

1	Introduction	2
2	Performance Specification Summary	2
3	Modifications.....	3
3.1	Output Voltage Setpoint.....	3
4	Test Setup and Results	4
4.1	Input/Output Connections.....	4
4.2	Start-Up Procedure	4
4.3	Efficiency.....	5
4.4	Load Regulation.....	6
4.5	Line Regulation	7
4.6	Load Transient Response	7
4.7	Output Voltage Ripple.....	8
4.8	Input Voltage Ripple	8
4.9	Start-Up	9
4.10	Shut-Down	10
5	Board Layout.....	11
5.1	Layout.....	11
6	Schematic, Bill of Materials, and Reference	12
6.1	Schematic	12
6.2	Bill of Materials	13
6.3	Reference	14

List of Figures

1	TPS563219EVM-663 Efficiency	5
2	TPS563219EVM-663 Light Load Efficiency	5
3	TPS563219EVM-663 Load Regulation, 5 V Input.....	6
4	TPS563219EVM-663 Load Regulation, 12 V Input	6
5	TPS563219EVM-663 Line Regulation	7
6	TPS563219EVM-663 Load Transient Response, 25% to 75% Load Step.....	7
7	TPS563219EVM-663 Output Voltage Ripple, $I_{OUT} = 3\text{ A}$	8
8	TPS563219EVM-663 Input Voltage Ripple, $I_{OUT} = 3\text{ A}$	8
9	TPS563219EVM-663 Start-Up Relative to V_{IN}	9
10	TPS563219EVM-663 Start-Up Relative to EN.....	9
11	TPS563219EVM-663 Shut-Down Relative to V_{IN}	10
12	TPS563219EVM-663 Shut-Down Relative to EN	10
13	Top Assembly.....	11
14	Top Layer.....	11
15	Bottom Layer.....	12

16	TPS563219EVM-663 Schematic Diagram	12
----	--	----

List of Tables

1	Input Voltage and Output Current Summary	2
2	TPS563219EVM-663 Performance Specifications Summary	2
3	Output Voltages	3
4	Connection and Test Points	4
5	Bill of Materials	13

1 Introduction

The TPS563219 is a single, adaptive on-time, D-CAP2™ mode, synchronous buck converter requiring a very low external component count. The D-CAP2 control circuit is optimized for low-ESR output capacitors such as POSCAP, SP-CAP, or ceramic types and features fast transient response with no external compensation. The slow start time is externally programmable and there is a dedicated Power Good (PG) pin to aid in voltage monitoring and sequencing. The switching frequency is internally set at a nominal 650 kHz. The high-side and low-side switching MOSFETs are incorporated inside the TPS563219 package along with the gate-drive circuitry. The low drain-to-source on resistance of the MOSFETs allows the TPS563219 to achieve high efficiencies and helps keep the junction temperature low at high output currents. The TPS563219 dc/dc synchronous converter is designed to provide up to a 3-A output from an input voltage source of 4.5 V to 17 V. The output voltage range is from 0.8 V to 6.5 V. Rated input voltage and output current ranges for the evaluation module are given in [Table 1](#).

The TPS563219EVM-663 evaluation module (EVM) is a single, synchronous buck converter providing 1.05 V at 3 A from 4.5-V to 17-V input. This user's guide describes the TPS563219EVM-663 performance.

Table 1. Input Voltage and Output Current Summary

EVM	Input Voltage Range	Output Current Range
TPS563219EVM-663	$V_{IN} = 4.5 \text{ V to } 17 \text{ V}$	0 A to 3 A

2 Performance Specification Summary

A summary of the TPS563219EVM-663 performance specifications is provided in [Table 2](#). Specifications are given for an input voltage of $V_{IN} = 12 \text{ V}$ and an output voltage of 1.05 V, unless otherwise noted. The ambient temperature is 25°C for all measurement, unless otherwise noted.

Table 2. TPS563219EVM-663 Performance Specifications Summary

Specifications		Test Conditions	Min	Typ	Max	Unit
Input voltage range (V_{IN})			4.5	12	17	V
CH1	Output voltage			1.05		V
	Operating frequency	$V_{IN} = 12 \text{ V}, I_O = 3 \text{ A}$		650		kHz
	Output current range		0		3	A
	Over current limit	$V_{IN} = 12 \text{ V}, L_O = 1.5 \mu\text{H}$				A
	Output ripple voltage	$V_{IN} = 12 \text{ V}, I_O = 3 \text{ A}$		20		mV _{PP}

3 Modifications

These evaluation modules are designed to provide access to the features of the TPS563219. Some modifications can be made to this module.

3.1 Output Voltage Setpoint

To change the output voltage of the EVMs, it is necessary to change the value of resistor R1. Changing the value of R1 can change the output voltage above 0.765 V. The value of R1 for a specific output voltage can be calculated using [Equation 1](#).

$$R1 = \frac{R2 \times (V_{OUT} - 0.765 \text{ V})}{0.765 \text{ V}} \quad (1)$$

[Table 3](#) lists the R1 values for some common output voltages. Note that the values given in [Table 3](#) are standard values and not the exact value calculated using [Table 3](#).

Table 3. Output Voltages

Output Voltage (V)	R1 (kΩ)	R2 (kΩ)	L1 (μH)			C5 + C6 + C7 (μF)
			Min	Typ	Max	
1.0	3.09	10.0	1.5	2.2	4.7	20 - 68
1.05	3.74	10.0	1.5	2.2	4.7	20 - 68
1.2	5.76	10.0	1.5	2.2	4.7	20 - 68
1.5	9.53	10.0	1.5	2.2	4.7	20 - 68
1.8	13.7	10.0	1.5	2.2	4.7	20 - 68
2.5	22.6	10.0	2.2	3.3	4.7	20 - 68
3.3	33.2	10.0	2.2	3.3	4.7	20 - 68
5.0	54.9	10.0	3.3	4.7	4.7	20 - 68
6.5	75.0	10.0	3.3	4.7	4.7	20 - 68

4 Test Setup and Results

This section describes how to properly connect, set up, and use the TPS563219EVM-663. The section also includes test results typical for the evaluation modules and efficiency, output load regulation, output line regulation, load transient response, output voltage ripple, input voltage ripple, start-up, and switching frequency.

4.1 Input/Output Connections

The TPS563219EVM-663 is provided with input/output connectors and test points as shown in [Table 4](#). A power supply capable of supplying 3 A must be connected to J1 through a pair of 20-AWG wires. The load must be connected to J2 through a pair of 20-AWG wires. The maximum load current capability is 3 A. Wire lengths must be minimized to reduce losses in the wires. Test point TP1 provides a place to monitor the V_{IN} input voltages with TP2 providing a convenient ground reference. TP7 is used to monitor the output voltage with TP8 as the ground reference.

Table 4. Connection and Test Points

Reference Designator	Function
J1	V_{IN} (see Table 1 for V_{IN} range)
J2	V_{OUT} , 1.05 V at 3-A maximum
JP1	EN control. Shunt EN to GND to disable, shunt EN to V_{IN} to enable.
TP1	V_{IN} positive monitor point
TP2	GND monitor test point
TP3	EN test point
TP4	Switch node test point
TP5	Test point for loop response measurements
TP6	V_{OUT} positive monitor point
TP7	GND monitor test point

4.2 Start-Up Procedure

1. Ensure that the jumper at JP1 (Enable control) pins 1 and 2 are covered to shunt EN to GND, disabling the output.
2. Apply appropriate V_{IN} voltage to VIN (J1-2) and GND (J1-1). See [Table 1](#) for V_{IN} voltage range.
3. Move the jumper at JP1 (Enable control) from pins 1 and 2 (EN and GND), to pins 2 and 3 (EN and V_{IN}) enabling the output.

4.3 Efficiency

Figure 1 shows the efficiency for the TPS563219EVM-663 at an ambient temperature of 25°C.

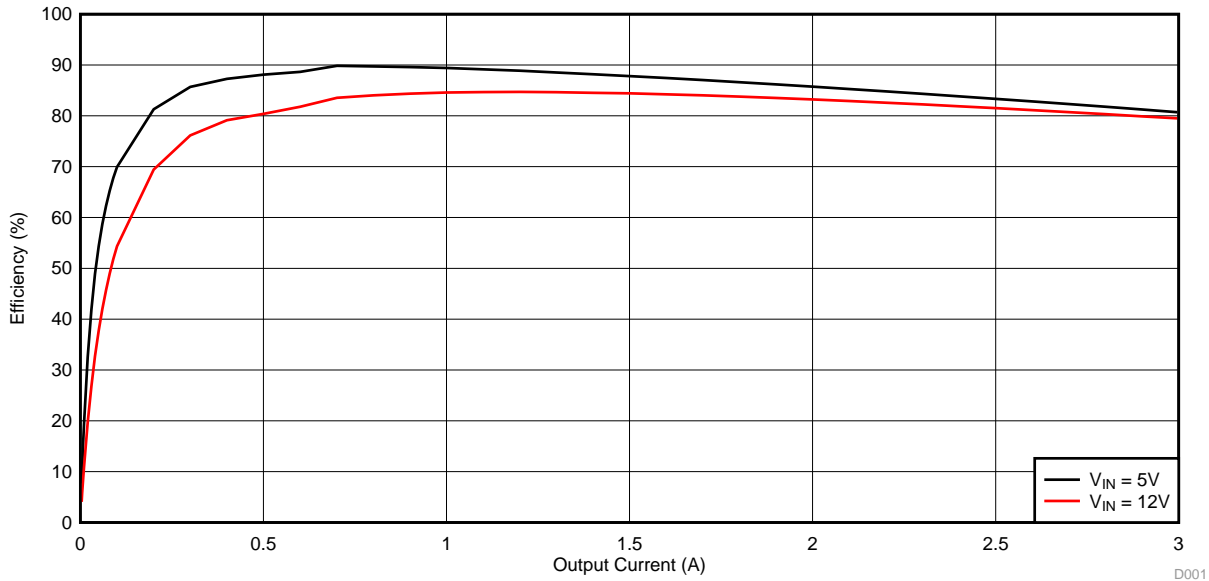

Figure 1. TPS563219EVM-663 Efficiency

Figure 2 shows the efficiency at light loads for the TPS563219EVM-663 at an ambient temperature of 25°C.

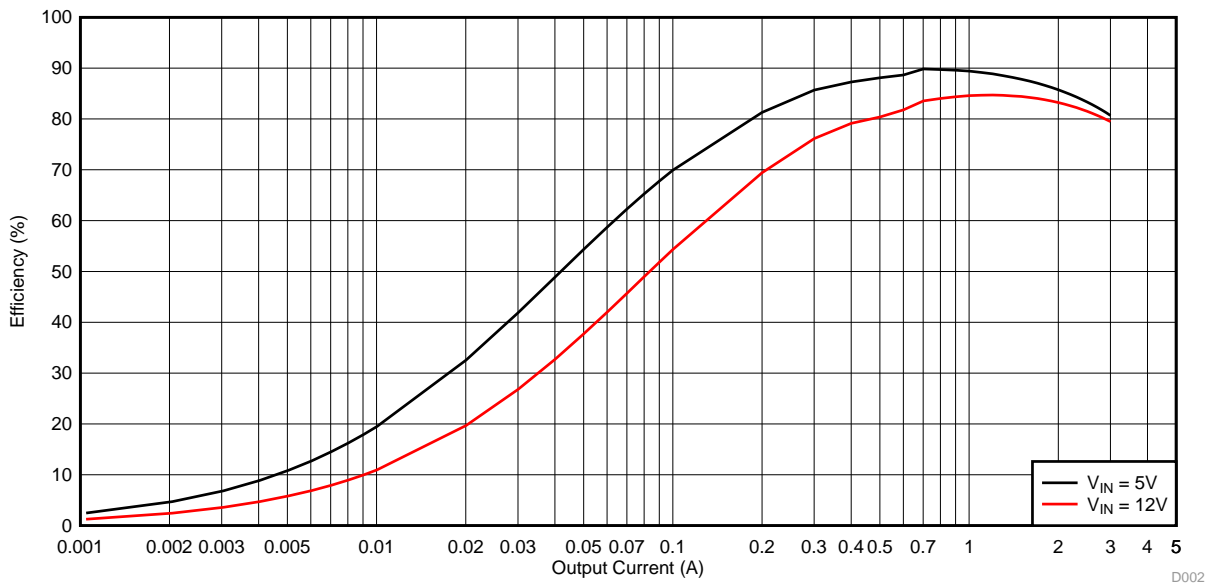

Figure 2. TPS563219EVM-663 Light Load Efficiency

4.4 Load Regulation

The load regulation for the TPS563219EVM-663 is shown in [Figure 3](#) and [Figure 4](#).

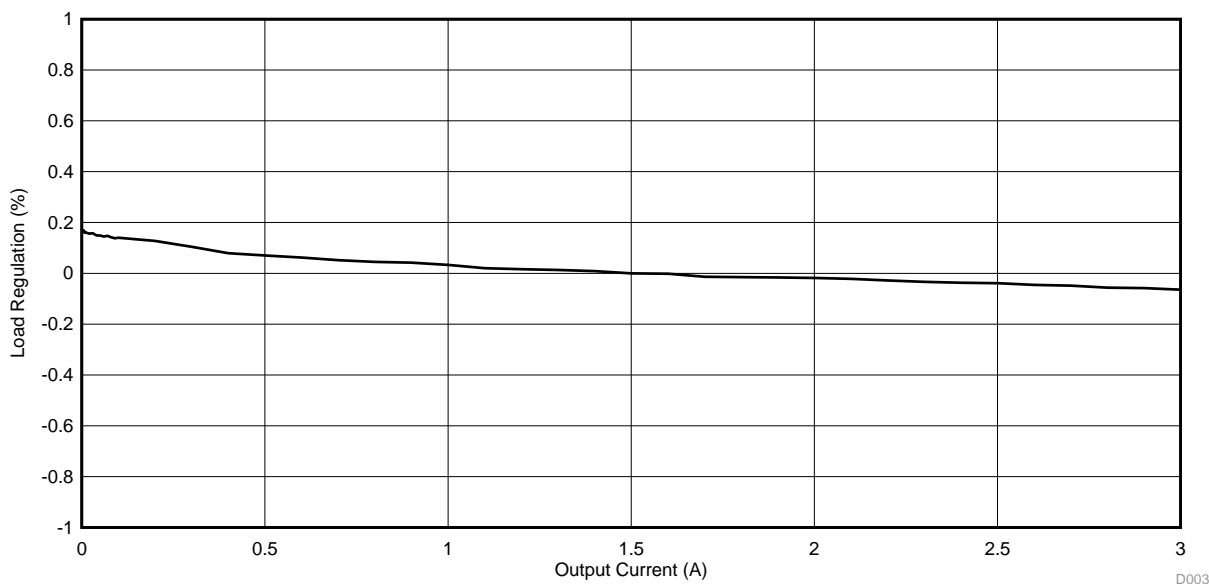

Figure 3. TPS563219EVM-663 Load Regulation, 5 V Input

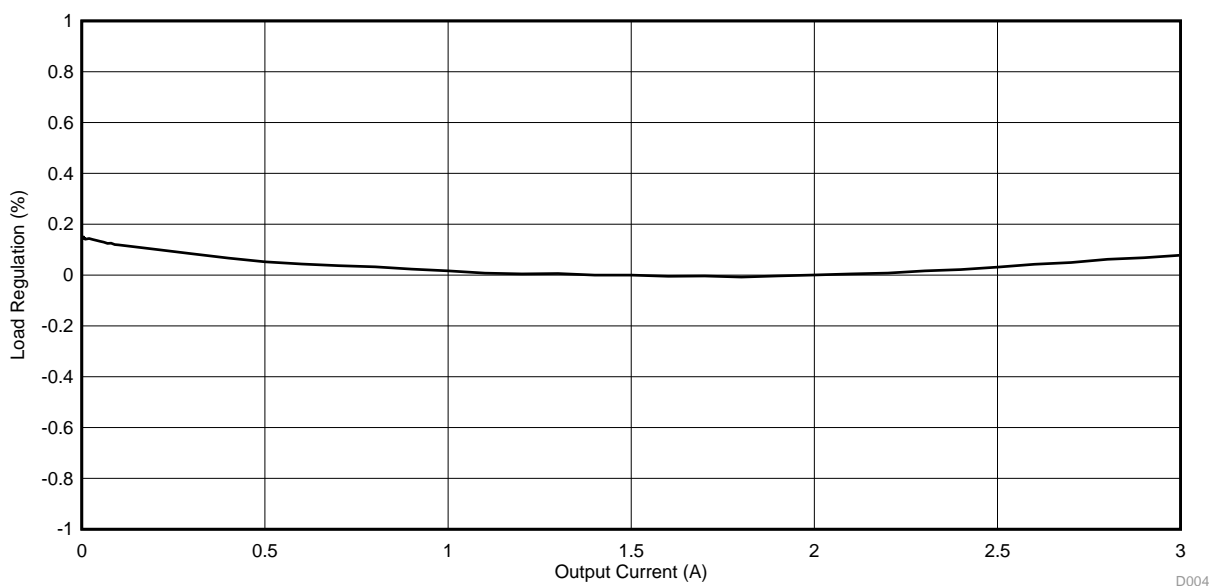

Figure 4. TPS563219EVM-663 Load Regulation, 12 V Input

4.5 Line Regulation

The line regulation for the TPS563219EVM-663 is shown in Figure 5.

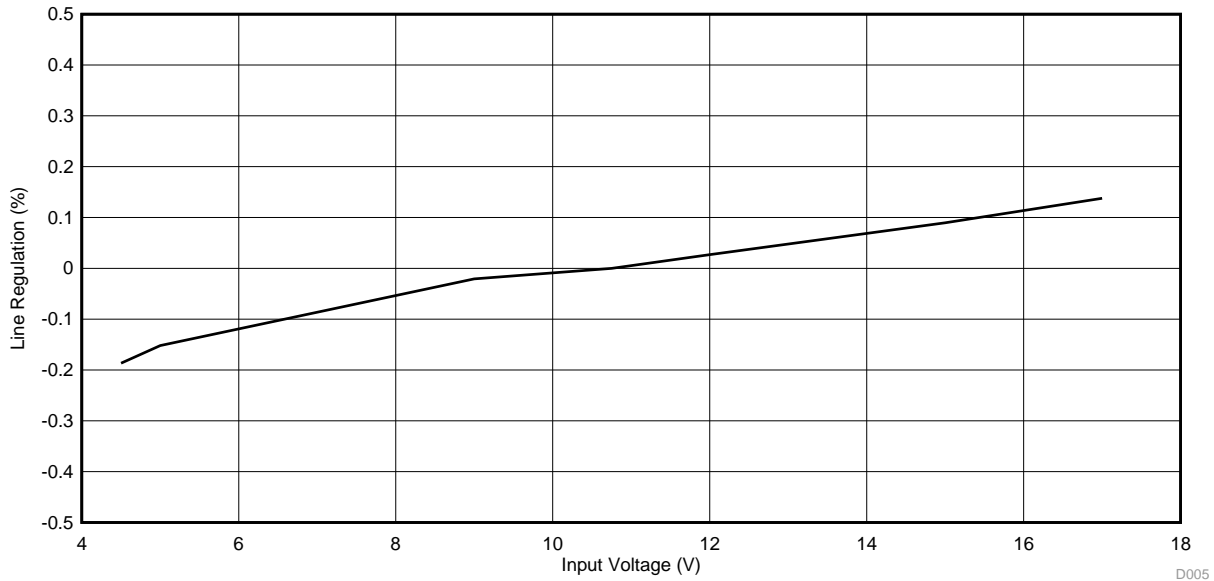

Figure 5. TPS563219EVM-663 Line Regulation

4.6 Load Transient Response

The TPS563219EVM-663 response to load transient is shown in Figure 6. The current steps and slew rates are indicated in the figures. Total peak-to-peak voltage variation is as shown.

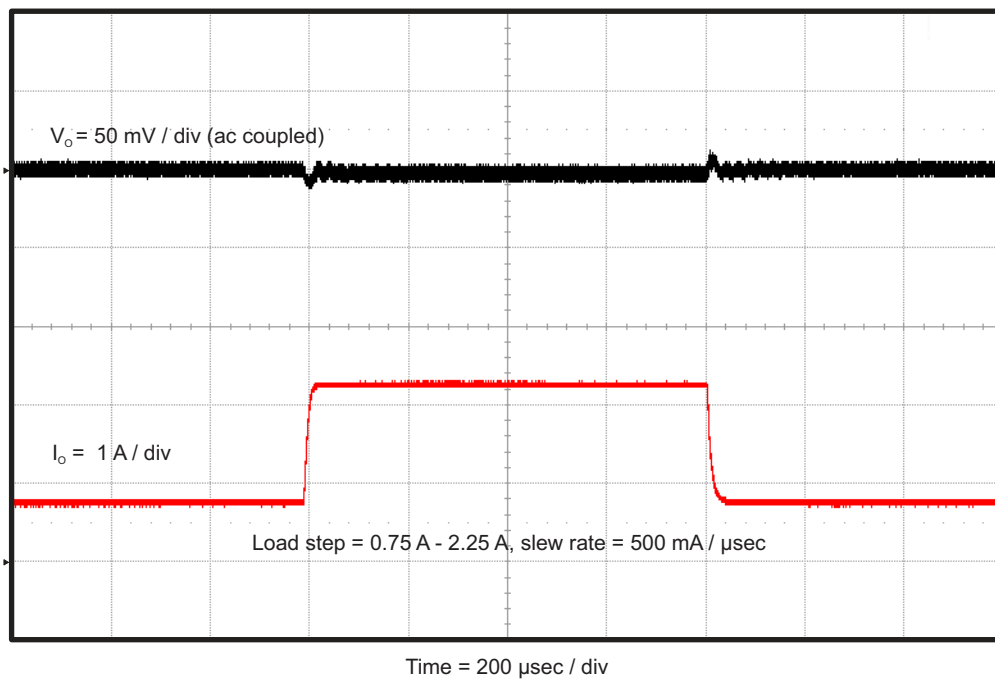

Figure 6. TPS563219EVM-663 Load Transient Response, 25% to 75% Load Step

4.7 Output Voltage Ripple

The TPS563219EVM-663 output voltage ripple is shown in [Figure 7](#). The output currents are as indicated.

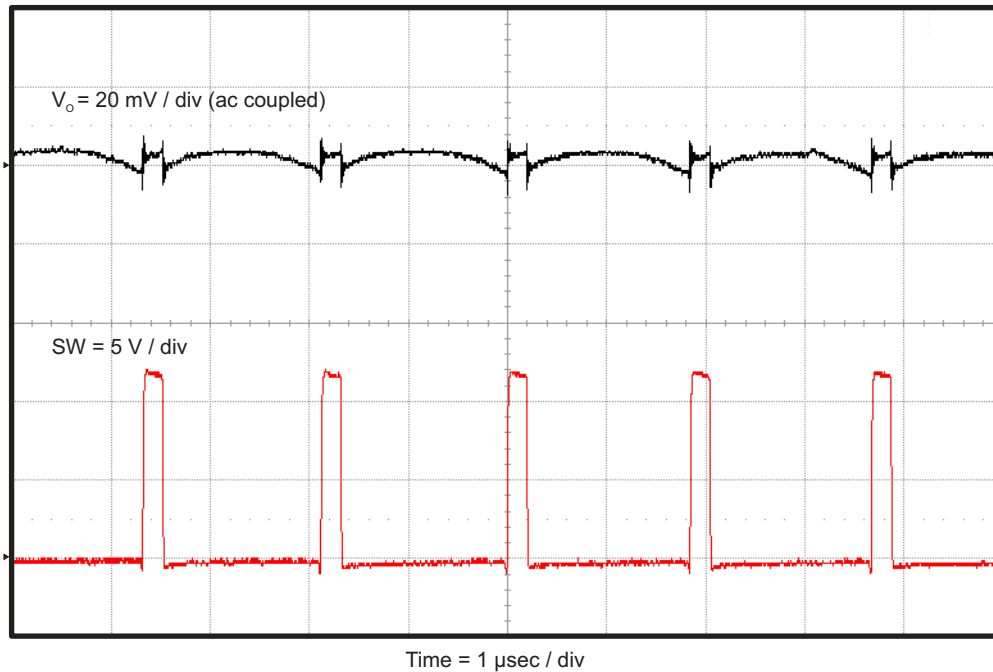

Figure 7. TPS563219EVM-663 Output Voltage Ripple, $I_{OUT} = 3 \text{ A}$

4.8 Input Voltage Ripple

The TPS563219EVM-663 input voltage ripple is shown in [Figure 8](#). The output current is as indicated.

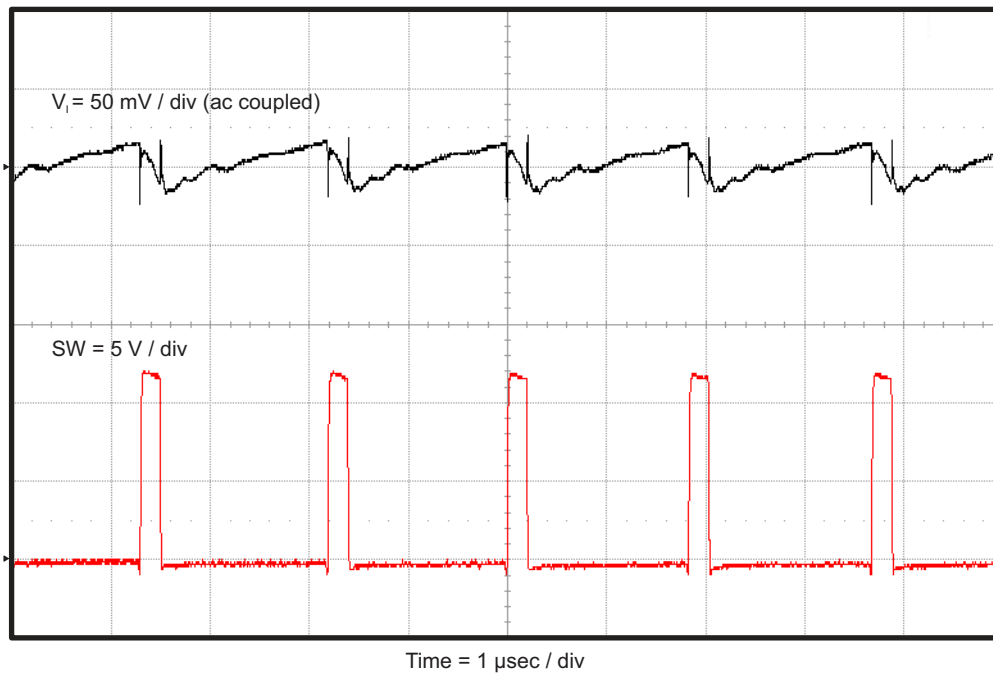

Figure 8. TPS563219EVM-663 Input Voltage Ripple, $I_{OUT} = 3 \text{ A}$

4.9 Start-Up

The TPS563219EVM-663 start-up waveform relative to V_{IN} is shown in Figure 9. Load = 1 Ω resistive.

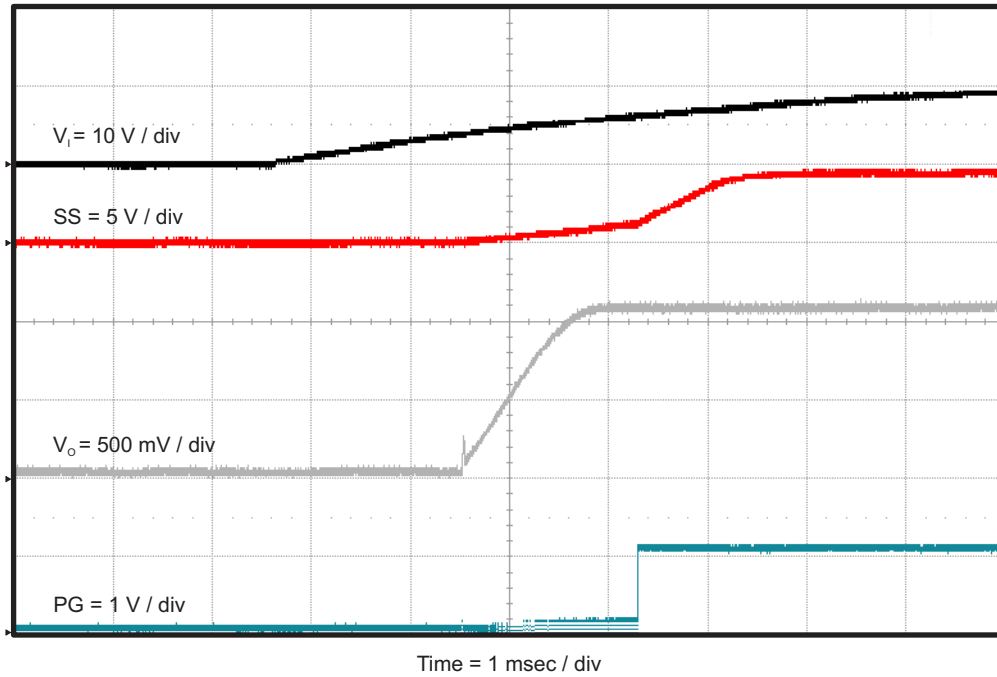

Figure 9. TPS563219EVM-663 Start-Up Relative to V_{IN}

The TPS563219EVM-663 start-up waveform relative to enable (EN) is shown in Figure 10. Load = 1 Ω resistive.

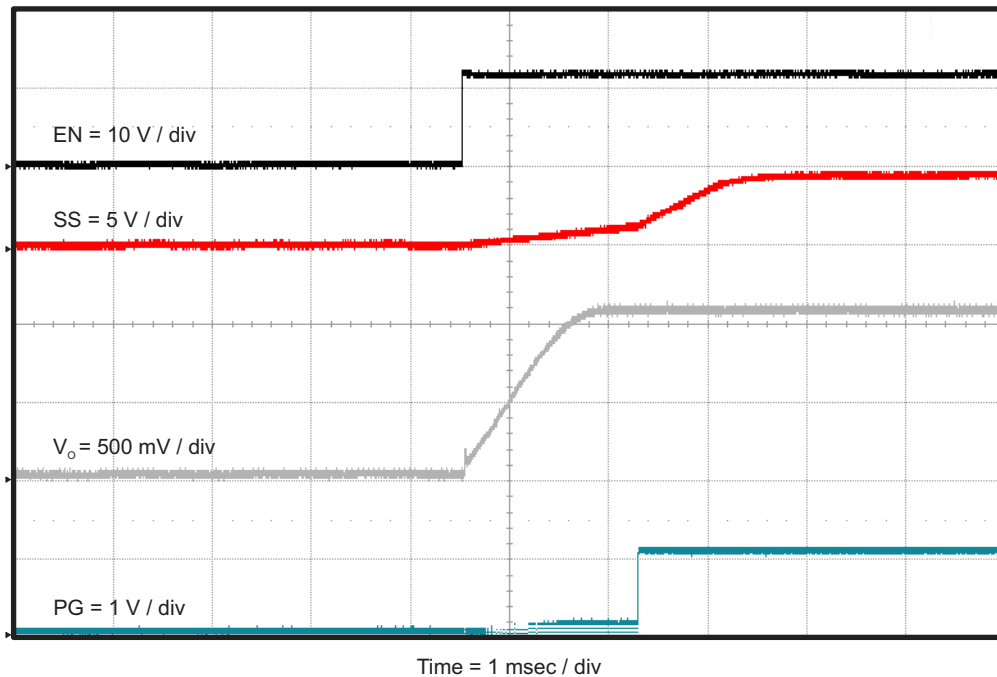

Figure 10. TPS563219EVM-663 Start-Up Relative to EN

4.10 Shut-Down

The TPS563219EVM-663 shut-down waveform relative to V_{IN} is shown in Figure 11. Load = 1 Ω resistive.

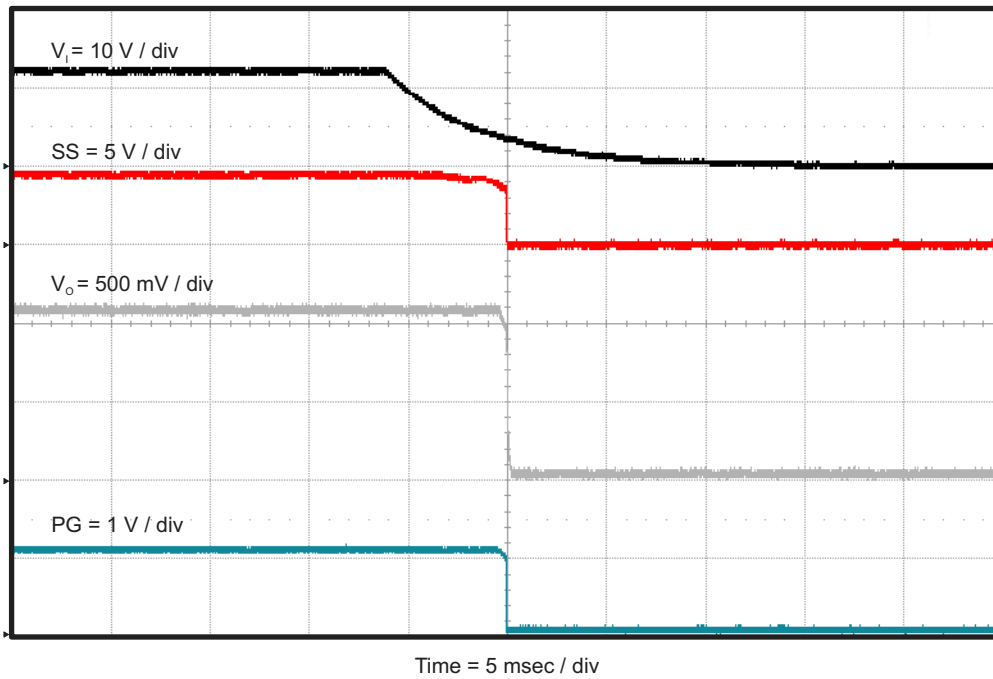

Figure 11. TPS563219EVM-663 Shut-Down Relative to V_{IN}

The TPS563219EVM-663 shut-down waveform relative to EN is shown in Figure 12. Load = 1 Ω resistive.

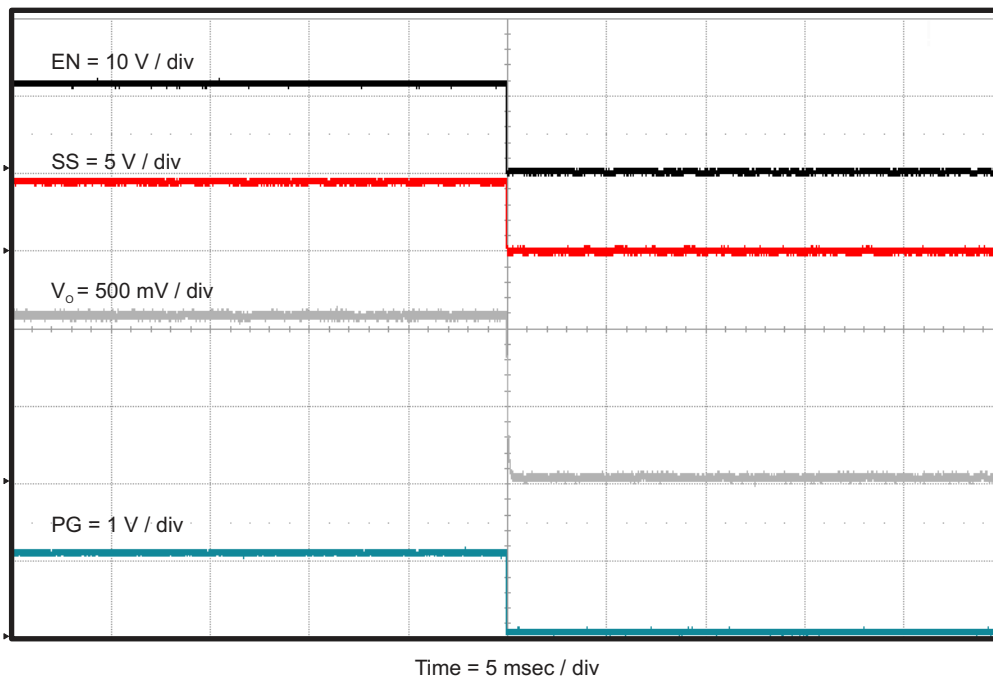

Figure 12. TPS563219EVM-663 Shut-Down Relative to EN

5 Board Layout

This section provides a description of the TPS563219EVM-663, board layout, and layer illustrations.

5.1 Layout

The board layout for the TPS563219EVM-663 is shown in [Figure 13](#), [Figure 14](#) and [Figure 15](#). The top layer contains the main power traces for VIN, VOUT, and ground. Also on the top layer are connections for the pins of the TPS563219 and a large area filled with ground. Most of the signal traces are also located on the top side. The input decoupling capacitors, C1, C2, and C3 are located as close to the IC as possible. The input and output connectors, test points, and all of the components are located on the top side. The bottom layer is a ground plane along with the switching node copper fill, signal ground copper fill and the feed back trace from the point of regulation to the top of the resistor divider network.

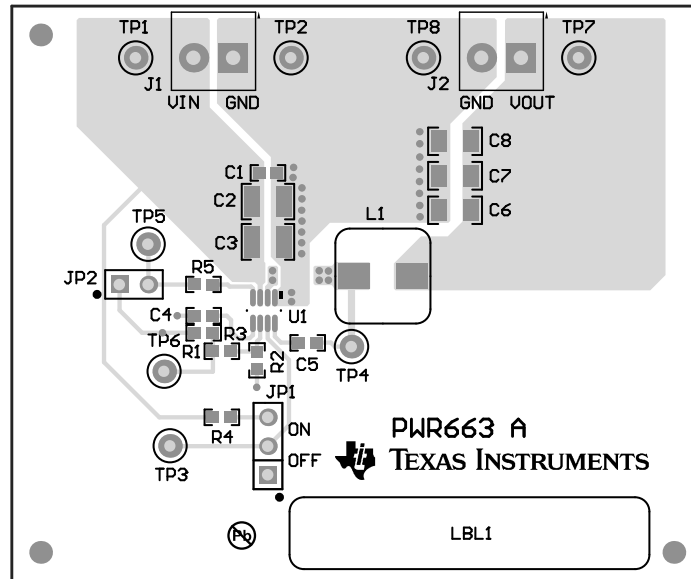

Figure 13. Top Assembly

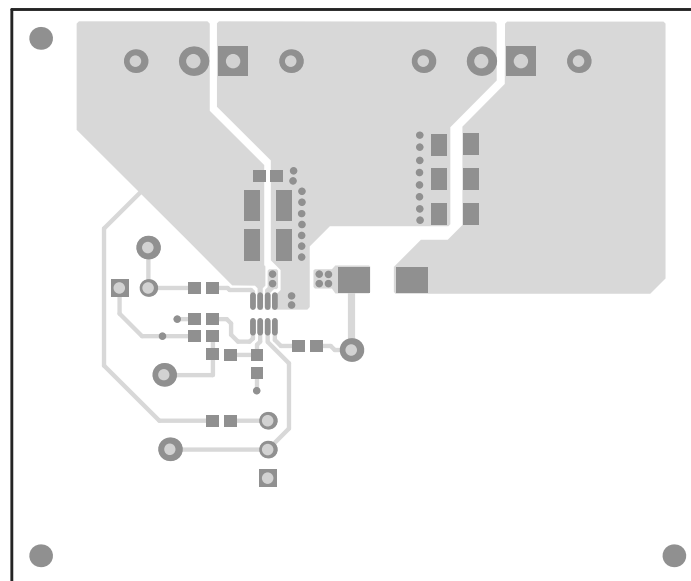

Figure 14. Top Layer

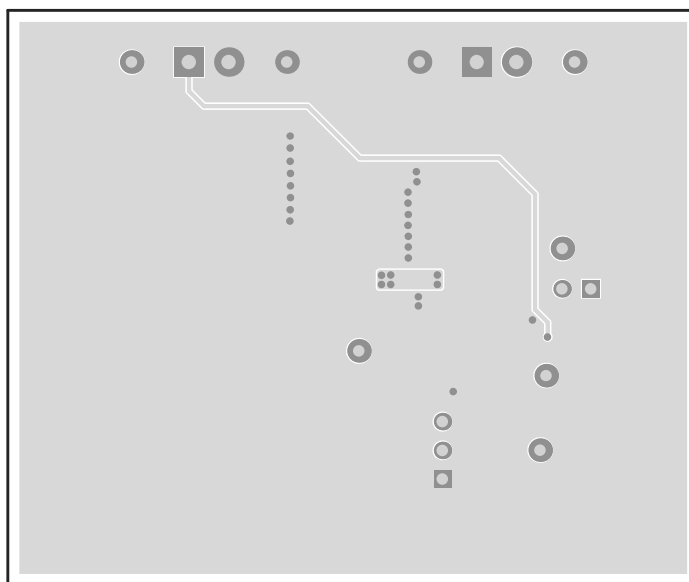

Figure 15. Bottom Layer

6 Schematic, Bill of Materials, and Reference

6.1 Schematic

Figure 16 is the schematic for the TPS563219EVM-663.

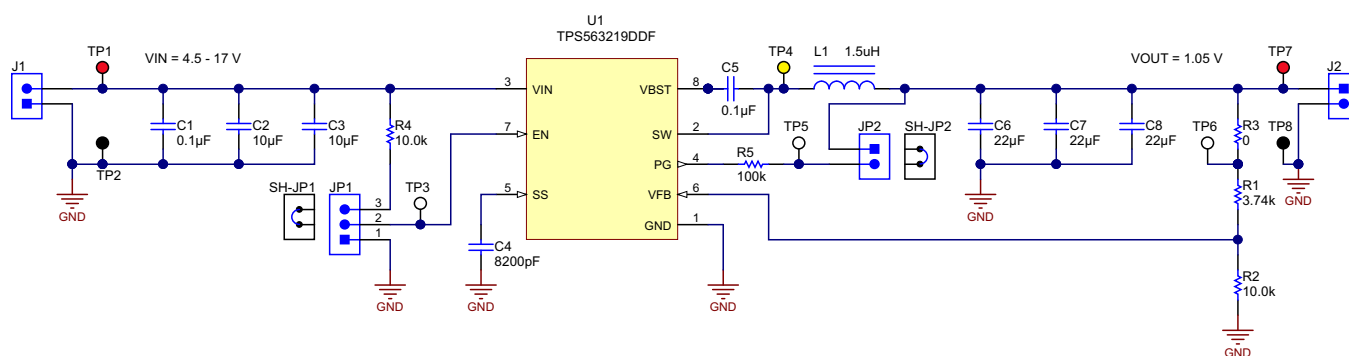

Figure 16. TPS563219EVM-663 Schematic Diagram

6.2 Bill of Materials

Table 5. Bill of Materials

Designator	Quantity	Value	Description	Package Reference	Part Number	Manufacturer
!PCB1	1		Printed Circuit Board		PWR663	Any
C1, C5	2	0.1uF	CAP, CERM, 0.1uF, 25V, +/-10%, X5R, 0603	0603	GRM188R61E104KA01D	MuRata
C2, C3	2	10uF	CAP, CERM, 10uF, 25V, +/-10%, X5R, 1210	1210	GRM32DR61E106KA12L	MuRata
C4	1	8200pF	CAP, CERM, 8200pF, 25V, +/-10%, X7R, 0603	0603	GRM188R71E822KA01D	MuRata
C6, C7, C8	3	22uF	CAP, CERM, 22uF, 10V, +/-10%, X7R, 1206	1206	GRM31CR71A226KE15L	MuRata
J1, J2	2		Terminal Block, 6A, 3.5mm Pitch, 2-Pos, TH	7.0x8.2x6.5mm	ED555/2DS	On-Shore Technology
JP1	1		Header, 100mil, 3x1, Tin, TH	Header, 3 PIN, 100mil, Tin	PEC03SAAN	Sullins Connector Solutions
JP2	1		Header, 100mil, 2x1, Tin, TH	Header, 2 PIN, 100mil, Tin	PEC02SAAN	Sullins Connector Solutions
L1	1	1.5uH	Inductor, Shielded Drum Core, Superflux, 1.5uH, 11A, 0.0078 ohm, SMD	WE-HC4	744311150	Würth Elektronik eiSos
LBL1	1		Thermal Transfer Printable Labels, 1.250" W x 0.250" H - 10,000 per roll	PCB Label 1.25"H x 0.250"W	THT-13-457-10	Brady
R1	1	3.74k	RES, 3.74k ohm, 1%, 0.1W, 0603	0603	CRCW06033K74FKEA	Vishay-Dale
R2, R4	2	10.0k	RES, 10.0k ohm, 1%, 0.1W, 0603	0603	CRCW060310K0FKEA	Vishay-Dale
R3	1	0	RES, 0 ohm, 5%, 0.1W, 0603	0603	ERJ-3GEY0R00V	Panasonic
R5	1	100k	RES, 100k ohm, 1%, 0.1W, 0603	0603	CRCW0603100KFKEA	Vishay-Dale
SH-JP1, SH-JP2	2	1x2	Shunt, 100mil, Gold plated, Black	Shunt	969102-0000-DA	3M
TP1, TP7	2	Red	Test Point, Miniature, Red, TH	Red Miniature Testpoint	5000	Keystone
TP2, TP8	2	Black	Test Point, Miniature, Black, TH	Black Miniature Testpoint	5001	Keystone
TP3, TP5, TP6	3	White	Test Point, Miniature, White, TH	White Miniature Testpoint	5002	Keystone
TP4	1	Yellow	Test Point, Miniature, Yellow, TH	Yellow Miniature Testpoint	5004	Keystone
U1	1		TPS56X21X 4.5V to 17 V Input, Synchronous Step-Down Voltage Regulator DDF0008A	DDF0008A	TPS563219DDF	Texas Instruments

6.3 Reference

1. *TPS56x219 4.5 V to 17 V Input, 2-A/3-A Synchronous Step-Down Voltage Regulator in SOT-23 data sheet* ([SLVSCM7](#))

IMPORTANT NOTICE

Texas Instruments Incorporated and its subsidiaries (TI) reserve the right to make corrections, enhancements, improvements and other changes to its semiconductor products and services per JESD46, latest issue, and to discontinue any product or service per JESD48, latest issue. Buyers should obtain the latest relevant information before placing orders and should verify that such information is current and complete. All semiconductor products (also referred to herein as "components") are sold subject to TI's terms and conditions of sale supplied at the time of order acknowledgment.

TI warrants performance of its components to the specifications applicable at the time of sale, in accordance with the warranty in TI's terms and conditions of sale of semiconductor products. Testing and other quality control techniques are used to the extent TI deems necessary to support this warranty. Except where mandated by applicable law, testing of all parameters of each component is not necessarily performed.

TI assumes no liability for applications assistance or the design of Buyers' products. Buyers are responsible for their products and applications using TI components. To minimize the risks associated with Buyers' products and applications, Buyers should provide adequate design and operating safeguards.

TI does not warrant or represent that any license, either express or implied, is granted under any patent right, copyright, mask work right, or other intellectual property right relating to any combination, machine, or process in which TI components or services are used. Information published by TI regarding third-party products or services does not constitute a license to use such products or services or a warranty or endorsement thereof. Use of such information may require a license from a third party under the patents or other intellectual property of the third party, or a license from TI under the patents or other intellectual property of TI.

Reproduction of significant portions of TI information in TI data books or data sheets is permissible only if reproduction is without alteration and is accompanied by all associated warranties, conditions, limitations, and notices. TI is not responsible or liable for such altered documentation. Information of third parties may be subject to additional restrictions.

Resale of TI components or services with statements different from or beyond the parameters stated by TI for that component or service voids all express and any implied warranties for the associated TI component or service and is an unfair and deceptive business practice. TI is not responsible or liable for any such statements.

Buyer acknowledges and agrees that it is solely responsible for compliance with all legal, regulatory and safety-related requirements concerning its products, and any use of TI components in its applications, notwithstanding any applications-related information or support that may be provided by TI. Buyer represents and agrees that it has all the necessary expertise to create and implement safeguards which anticipate dangerous consequences of failures, monitor failures and their consequences, lessen the likelihood of failures that might cause harm and take appropriate remedial actions. Buyer will fully indemnify TI and its representatives against any damages arising out of the use of any TI components in safety-critical applications.

In some cases, TI components may be promoted specifically to facilitate safety-related applications. With such components, TI's goal is to help enable customers to design and create their own end-product solutions that meet applicable functional safety standards and requirements. Nonetheless, such components are subject to these terms.

No TI components are authorized for use in FDA Class III (or similar life-critical medical equipment) unless authorized officers of the parties have executed a special agreement specifically governing such use.

Only those TI components which TI has specifically designated as military grade or "enhanced plastic" are designed and intended for use in military/aerospace applications or environments. Buyer acknowledges and agrees that any military or aerospace use of TI components which have **not** been so designated is solely at the Buyer's risk, and that Buyer is solely responsible for compliance with all legal and regulatory requirements in connection with such use.

TI has specifically designated certain components as meeting ISO/TS16949 requirements, mainly for automotive use. In any case of use of non-designated products, TI will not be responsible for any failure to meet ISO/TS16949.

Products

Audio	www.ti.com/audio
Amplifiers	amplifier.ti.com
Data Converters	dataconverter.ti.com
DLP® Products	www.dlp.com
DSP	dsp.ti.com
Clocks and Timers	www.ti.com/clocks
Interface	interface.ti.com
Logic	logic.ti.com
Power Mgmt	power.ti.com
Microcontrollers	microcontroller.ti.com
RFID	www.ti-rfid.com
OMAP Applications Processors	www.ti.com/omap
Wireless Connectivity	www.ti.com/wirelessconnectivity

Applications

Automotive and Transportation	www.ti.com/automotive
Communications and Telecom	www.ti.com/communications
Computers and Peripherals	www.ti.com/computers
Consumer Electronics	www.ti.com/consumer-apps
Energy and Lighting	www.ti.com/energy
Industrial	www.ti.com/industrial
Medical	www.ti.com/medical
Security	www.ti.com/security
Space, Avionics and Defense	www.ti.com/space-avionics-defense
Video and Imaging	www.ti.com/video

TI E2E Community

e2e.ti.com