

TPS62097-Q1 2-A High Efficiency Step-Down Converter in Wettable Flanks QFN Package

1 Features

- AEC-Q100 Qualified With the Following Results:
 - Device Temperature Grade 1: -40°C to 125°C Operating Junction Temperature Range
 - Device HBM ESD Classification Level 2
 - Device CDM ESD Classification Level C6
- iDCS-Control Topology with Selectable Switching Frequency
- Forced PWM or Power Save Mode
- Up to 97% Efficiency
- 2.5-V to 6.0-V Input Voltage
- 0.8-V to V_{IN} Adjustable Output Voltage
- 3.3-V Fixed Output Voltage, TPS6209733-Q1
- $\pm 1\%$ Output Voltage Accuracy
- Hiccup Short Circuit Protection
- Programmable Soft Startup
- Output Voltage Tracking
- 100% Duty Cycle for Lowest Dropout
- Output Discharge
- Power Good Output
- Thermal Shutdown Protection
- Available in 3-mm x 3-mm QFN Package with Wettable Flanks

2 Applications

- Gateway
- Head Unit
- Instrumentation Cluster
- Telematics

3 Description

The TPS62097-Q1 device is a synchronous step-down converter optimized for high efficiency and noise critical applications. The devices focus on high efficiency conversion over a wide output current range. At medium to heavy loads, the converter operates in PWM mode and automatically enters Power Save Mode operation at light load. The switching frequency is selectable in the range of 1.5 MHz to 2.5 MHz by an external resistor. iDCS-Control is able to be operated in a forced PWM mode for low noise operation with a constant switching frequency.

To address the requirements of system power rails, the internal compensation circuit allows a large selection of external output capacitor values in excess of $150\ \mu\text{F}$. To control the inrush current during the startup, the device provides a programmable soft startup by an external capacitor connected to the SS/TR pin. The SS/TR pin is also used in voltage tracking configurations. The device integrates short circuit protection, power good and thermal shutdown features.

Device Information⁽¹⁾

PART NUMBER	PACKAGE	BODY SIZE (NOM)
TPS62097-Q1	QFN (16)	3.0 mm x 3.0 mm
TPS6209733-Q1	QFN (16)	3.0 mm x 3.0 mm

(1) For all available packages, see the orderable addendum at the end of the datasheet.

Output Voltage Options

PART NUMBER	OUTPUT VOLTAGE	MARKING SYMBOL
TPS62097-Q1	Adj.	9700Q
TPS6209733-Q1	3.3 V	9733Q

1.8-V Output, Typical Application

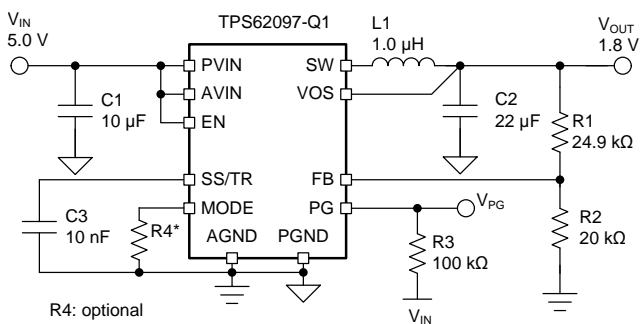

Copyright © 2016, Texas Instruments Incorporated

1.8-V Output, Efficiency, MODE = Open

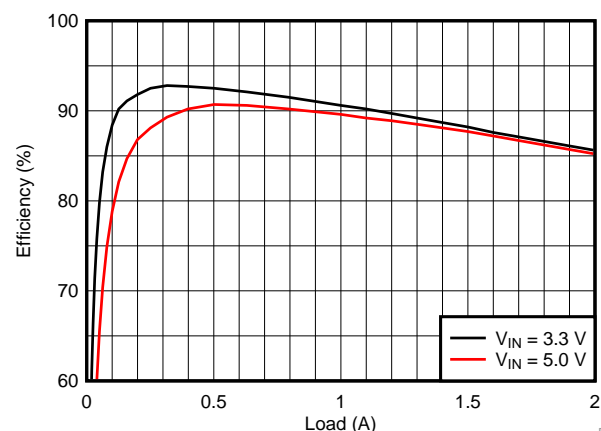

D026



Table of Contents

1	Features	1	7.4	Device Function Modes	8
2	Applications	1	8	Application Information	12
3	Description	1	8.1	Application Information.....	12
4	Revision History	2	8.2	1.8-V Output Application	12
5	Terminal Configuration and Functions	3	9	Power Supply Recommendations	17
6	Specifications	4	10	PCB Layout	18
6.1	Absolute Maximum Ratings	4	10.1	Layout Guidelines	18
6.2	ESD Ratings.....	4	10.2	Layout Example	18
6.3	Recommend Operating Conditions.....	4	10.3	Thermal Information.....	18
6.4	Thermal Information	4	11	Device and Documentation Support	19
6.5	Electrical Characteristics.....	5	11.1	Device Support	19
6.6	Typical Characteristics.....	6	11.2	Community Resources.....	19
7	Detailed Description	7	11.3	Trademarks	19
7.1	Overview	7	11.4	Electrostatic Discharge Caution.....	19
7.2	Functional Block Diagram	7	11.5	Glossary	19
7.3	Feature Description.....	8	12	Mechanical, Packaging, and Orderable Information	19

4 Revision History

Changes from Original (August 2017) to Revision A

Page

•	Production Data release.	1
---	-------------------------------	----------

5 Terminal Configuration and Functions

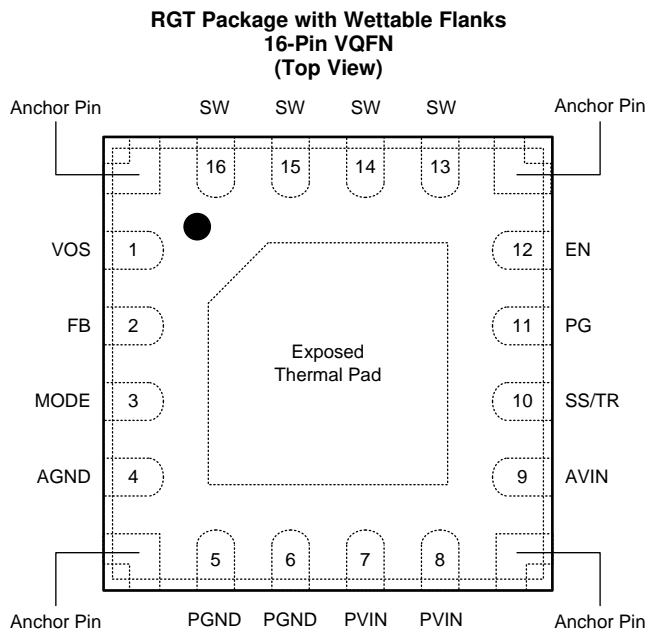

Pin Functions

PIN		I/O	DESCRIPTION
NAME	NO.		
PGND	5,6		Power ground pin.
SW	13,14,15,16	PWR	Switch pin. It is connected to the internal MOSFET switches. Connect the external inductor between this terminal and the output capacitor.
VOS	1	I	Output voltage sense pin. This pin must be directly connected to the output capacitor.
FB	2	I	Feedback pin. For the adjustable output voltage version, a resistor divider sets the output voltage. For the fixed output voltage versions, this pin is recommended to be connected to AGND for improved thermal performance. The pin also can be left floating as an internal 400kΩ resistor is connected between this pin and AGND for fixed output voltage versions.
PG	11	O	Power good open drain output pin. The pull-up resistor should not be connected to any voltage higher than 6 V. If it's not used, leave the pin floating.
EN	12	I	Enable pin. To enable the device this pin needs to be pulled high. Pulling this pin low disables the device. This pin has an internal pull-down resistor of typically 375kΩ when the device is disabled.
PVIN	7,8	PWR	Power input supply pin.
AVIN	9	I	Analog input supply pin. Connect it to the PVIN pin together.
SS/TR	10	I	Soft startup and voltage tracking pin. A capacitor is connected to this pin to set the soft startup time. Leaving this pin floating sets the minimum startup time.
MODE	3	I	Mode selection pin. Connect this pin to AGND to enable Power Save Mode with automatic transition between PWM and Power Save Mode. Connect this pin to an external resistor or leave floating to enable forced PWM mode only. See Table 1 .
AGND	4		Analog ground pin.
Exposed Thermal Pad			The exposed thermal pad is connected to AGND. It must be soldered for mechanical reliability.
Anchor Pins			These pins do not require an electrical connection but can be connected to AGND. They must be soldered for mechanical reliability. Refer to EXAMPLE BOARD LAYOUT at the end of this data sheet.

6 Specifications

6.1 Absolute Maximum Ratings⁽¹⁾

		MIN	MAX	UNIT
Voltage at Pins ⁽²⁾	AVIN, PVIN, EN, VOS, PG	-0.3	6.0	V
	MODE, SS/TR, SW (DC)	-0.3	V _{IN} +0.3V	
	FB	-0.3	3.0	
	SW (AC, less than 100ns) ⁽³⁾	-3	11	
Sink current	PG	0	1.0	mA
Temperature	Operating Junction, T _J	-40	150	°C
	Storage, T _{stg}	-65	150	

- (1) Stresses beyond those listed under absolute maximum ratings may cause permanent damage to the device. These are stress ratings only, and functional operation of the device at these or any other conditions beyond those indicated under recommended operating conditions is not implied. Exposure to absolute-maximum-rated conditions for extended periods may affect device reliability.
- (2) All voltage values are with respect to network ground terminal.
- (3) While switching.

6.2 ESD Ratings

			VALUE	UNIT
V _{ESD}	Electrostatic discharge	Human-body model (HBM), per AEC Q100-002 ⁽¹⁾	±2500	V
		Charged-device model (CDM), per AEC Q100-011 ⁽¹⁾	±1500	

- (1) AEC Q100-002 indicates that HBM stressing shall be in accordance with the ANSI/ESDA/JEDEC JS-001 specification.

6.3 Recommend Operating Conditions

		MIN	MAX	UNIT
V _{IN}	Input voltage range	2.5	6.0	V
V _{PG}	Pull-up resistor voltage	0	6.0	V
V _{OUT}	Output voltage range	0.8	V _{IN}	V
I _{OUT}	Output current range	0	2.0	A
T _J	Operating junction temperature	-40	125	°C

6.4 Thermal Information

	THERMAL METRIC ⁽¹⁾	TPS62097-Q1WRGT	UNITS
R _{θJA}	Junction-to-ambient thermal resistance	44.2	°C/W
R _{θJC(top)}	Junction-to-case (top) thermal resistance	51.7	°C/W
R _{θJB}	Junction-to-board thermal resistance	19.3	°C/W
Ψ _{JT}	Junction-to-top characterization parameter	1.1	°C/W
Ψ _{JB}	Junction-to-board characterization parameter	19.3	°C/W
R _{θJC(bot)}	Junction-to-case (bottom) thermal resistance	3.6	°C/W

- (1) For more information about traditional and new thermal metrics, see the IC Package Thermal Metrics application report, [SPRA953](#)

6.5 Electrical Characteristics

$T_J = -40^{\circ}\text{C}$ to 125°C , and $V_{IN} = 2.5\text{V}$ to 6.0V . Typical values are at $T_J = 25^{\circ}\text{C}$ and $V_{IN} = 3.6\text{V}$, unless otherwise noted.

PARAMETER		TEST CONDITIONS	MIN	TYP	MAX	UNIT
SUPPLY						
I_Q	Quiescent current into AVIN, PVIN	EN = High, Device not switching, $T_J = -40^{\circ}\text{C}$ to 85°C	40	57		μA
		EN = High, Device not switching	40	65		
I_{SD}	Shutdown current into AVIN, PVIN	EN = Low, $T_J = -40^{\circ}\text{C}$ to 85°C	0.7	3		μA
		EN = Low	0.7	10		
V_{UVLO}	Under voltage lock out threshold	V_{IN} falling	2.2	2.3	2.4	V
		V_{IN} rising	2.3	2.4	2.5	
T_{QJSD}	Thermal shutdown threshold	T_J rising		160		$^{\circ}\text{C}$
	Thermal shutdown hysteresis	T_J falling		20		$^{\circ}\text{C}$
LOGIC INTERFACE (EN, MODE)						
V_{H_EN}	High-level input voltage, EN pin		1.6	2.0		V
V_{L_EN}	Low-level input voltage, EN pin		1.0	1.3		V
$I_{EN,LKG}$	Input leakage current into EN pin	EN = High	0.01	0.9		μA
R_{PD}	Pull-down resistance at EN pin	EN = Low		375		k Ω
V_{H_MO}	High-level input voltage, MODE pin			1.2		V
V_{L_MO}	Low-level input voltage, MODE pin		0.4			V
$I_{MO,LKG}$	Input leakage current into MODE pin	MODE = High	0.01	0.16		μA
SOFT STARTUP, POWER GOOD (SS/TR, PG)						
I_{SS}	Soft startup current		5.5	7.5	9.5	μA
	Voltage tracking gain factor	$V_{FB} / V_{SS/TR}$		1		
V_{PG}	Power good threshold	V_{OUT} rising, referenced to V_{OUT} nominal	92	95	98	%
		V_{OUT} falling, referenced to V_{OUT} nominal	87	90	92	
$V_{PG,OL}$	Low-level output voltage, PG pin	$I_{sink} = 1\text{mA}$		0.4		V
$I_{PG,LKG}$	Input leakage current into PG pin	$V_{PG} = 5.0\text{V}$	0.01	1.6		μA
OUTPUT						
V_{OUT}	Output voltage accuracy TPS6209733Q	PWM mode, No load	-1.0		1.0	%
		PSM mode ⁽¹⁾	-1.0		2.1	
V_{FB}	Feedback reference voltage	PWM mode	792	800	808	mV
		PSM mode ⁽¹⁾	792	800	817	
$I_{FB,LKG}$	Input leakage current into FB pin	$V_{FB} = 0.8\text{V}$		0.01	0.1	μA
R_{DIS}	Output discharge resistor	EN = Low, $V_{OUT} = 1.8\text{V}$		165		Ω
	Line regulation	$I_{OUT} = 0.5\text{A}$, $V_{OUT} = 1.8\text{V}^{(1)}$		0.02		%/V
	Load regulation	PWM mode, $V_{OUT} = 1.8\text{V}^{(1)}$		0.2		%/A
POWER SWITCH						
$R_{DS(on)}$	High-side FET on-resistance	$I_{SW} = 500\text{mA}$, $V_{IN} = 5.0\text{V}$		42		m Ω
		$I_{SW} = 500\text{mA}$, $V_{IN} = 3.6\text{V}$		53		
	Low-side FET on-resistance	$I_{SW} = 500\text{mA}$, $V_{IN} = 5.0\text{V}$		40		m Ω
		$I_{SW} = 500\text{mA}$, $V_{IN} = 3.6\text{V}$		50		
I_{LIMF}	High-side FET forward current limit		3.1	3.6	4.2	A
		$V_{IN} = 5.0\text{V}$	3.3	3.6	3.9	
I_{LIMN}	Low-side FET negative current limit	Forced PWM mode	-1.25	-1.1	-0.7	A

(1) Conditions: L = 1 μH , $C_{OUT} = 22\mu\text{F}$, Switching Frequency = 2.0MHz

6.6 Typical Characteristics

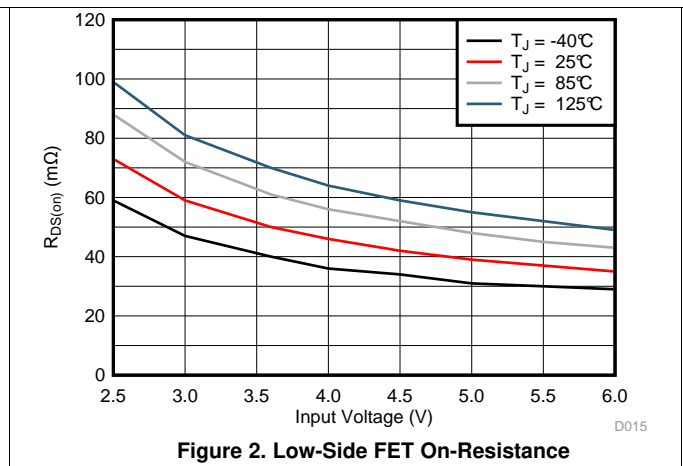
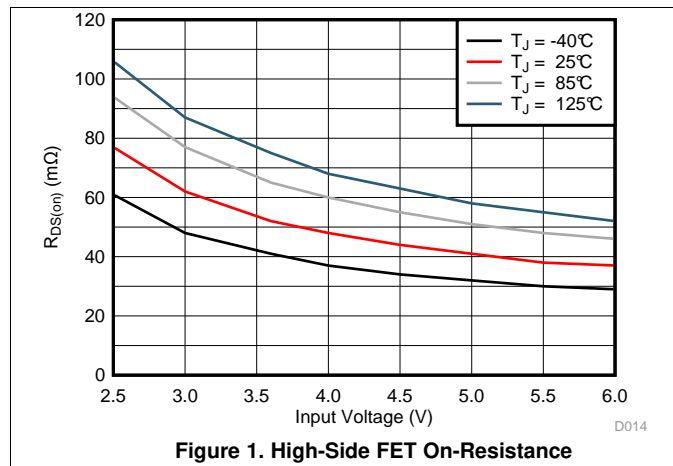

7 Detailed Description

7.1 Overview

The TPS62097-Q1 synchronous step-down converter is based on the iDCS-Control (Industrial Direct Control with Seamless transition into Power Save Mode) topology. The control topology not only keeps the advantages of DCS-Control, but also provides other features:

- Forced PWM mode over the whole load range
- Selectable PWM switching frequency
- 1% output voltage accuracy
- Output voltage sequencing and tracking

The iDCS-Control topology operates in PWM (Pulse Width Modulation) mode for medium to heavy load conditions and in Power Save Mode (PSM) at light load conditions. Or the forced PWM mode removes power save mode operation and operates the device always at its nominal switching frequency.

In PWM mode, the device operates with a predictive On-time switching pulse. A constant switching frequency over the input and output voltage range is achieved by using an input and output voltage feed forward to set the on-time, as shown in Table 1. In PSM mode, the switching frequency is reduced to achieve high efficiency over the entire load current range. Since iDCS-Control supports both operation modes within a single building block, the transition from PWM mode to Power Save Mode is seamless and without effects on the output voltage.

7.2 Functional Block Diagram

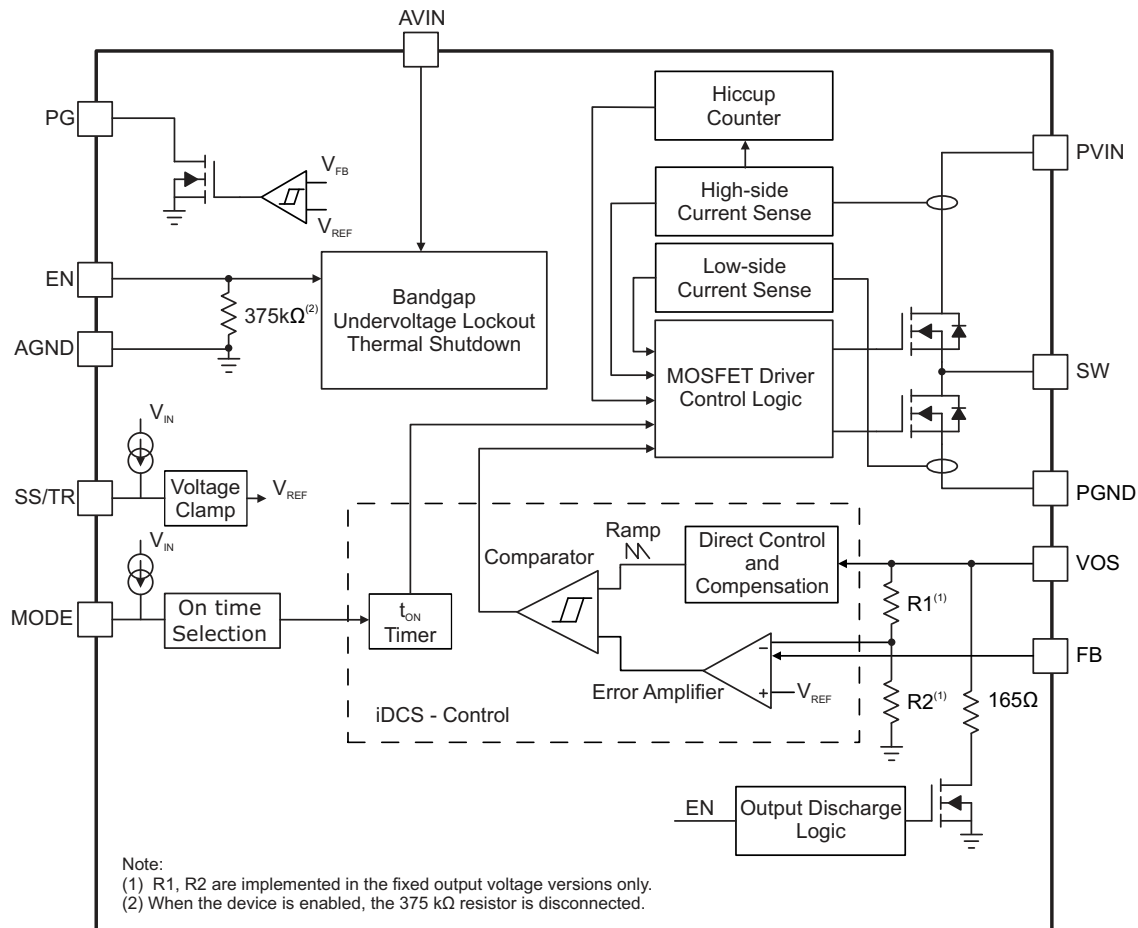

7.3 Feature Description

7.3.1 100% Duty Cycle Mode

The device offers a low input to output voltage dropout by entering 100% duty cycle mode, when the input voltage reaches the level of the output voltage. In this mode the high-side MOSFET switch is constantly turned on and the low-side MOSFET is switched off. The minimum input voltage to maintain output regulation, depending on the load current and output voltage, is calculated as:

$$V_{IN(min)} = V_{OUT(min)} + I_{OUT} \times (R_{DS(on)} + R_L)$$

where

- $V_{IN(min)}$ = Minimum input voltage to maintain a minimum output voltage
- I_{OUT} = Output current
- $R_{DS(on)}$ = High side FET on-resistance
- R_L = Inductor ohmic resistance (DCR) (1)

When the device operates close to 100% duty cycle mode, the TPS62097-Q1 can't enter Power Save Mode regardless of the load current if the input voltage decreases to typically 15% above the output voltage. The device maintains output regulation in PWM mode.

7.3.2 Switch Current Limit and Hiccup Short Circuit Protection

The switch current limit prevents the devices from high inductor current and from drawing excessive current from the battery or input voltage rail. Excessive current might occur with a shorted/saturated inductor or a heavy load/shorted output circuit condition. If the inductor current reaches the threshold I_{LIMF} , the high-side MOSFET is turned off and the low-side MOSFET is turned on to ramp down the inductor current. Once this switch current limit is triggered 32 times, the devices stop switching and enable the output discharge. The devices then automatically start a new startup after a typical delay time of 100 μ s has passed. This is HICCUP short circuit protection and is implemented to reduce the current drawn during a short circuit condition. The devices repeat this mode until the high load condition disappears.

When the device is in forced PWM mode, the negative current limit of the low-side MOSFET is active. The negative current limit prevents excessive current from flowing back through the inductor to the input.

7.3.3 Under Voltage Lockout (UVLO)

To avoid mis-operation of the device at low input voltages, an under voltage lockout is implemented, which shuts down the devices at voltages lower than V_{UVLO} with a hysteresis of 100mV.

7.3.4 Thermal Shutdown

The device goes into thermal shutdown and stops switching once the junction temperature exceeds T_{JSD} . Once the device temperature falls below the threshold by 20°C, the device returns to normal operation automatically.

7.4 Device Function Modes

7.4.1 Enable and Disable (EN)

The device is enabled by setting the EN pin to a logic High. Accordingly, shutdown mode is forced if the EN pin is pulled Low with a shutdown current of typically 0.7 μ A.

In shutdown mode, the internal power switches as well as the entire control circuitry are turned off. An internal resistor of 165 Ω discharges the output via the VOS pin smoothly. The output discharge function also works when thermal shutdown, undervoltage lockout or HICCUP short circuit protection are triggered.

An internal pull-down resistor of 375 k Ω is connected to the EN pin when the EN pin is Low. The pull-down resistor is disconnected when the EN pin is High.

7.4.2 Power Save Mode and Forced PWM Mode (MODE)

The MODE pin is a multi-functional pin that allows the device operation in forced PWM mode or PWM/PSM mode, and to select the PWM switching frequency.

Device Function Modes (continued)

Once the EN pin is pulled high, the IC enables internal circuit blocks and prepares to ramp the output up. The period between the rising edge of the EN pin and the beginning of the power stage switching is called the MODE detection time, typically 50µs. During the MODE detection time period, shown in Figure 3, the PWM switching frequency and operating mode are set by the MODE pin status, as shown in Table 1.

The PWM switching frequency can't be changed after the detection time period. Only when the device is set in PWM/PSM mode during the MODE detection time period (MODE = AGND), it is possible to switch between PWM/PSM and forced PWM operation modes by toggling the MODE pin with a GPIO pin of a micro-controller, for example. The other four MODE pin selections force the device in PWM mode only.

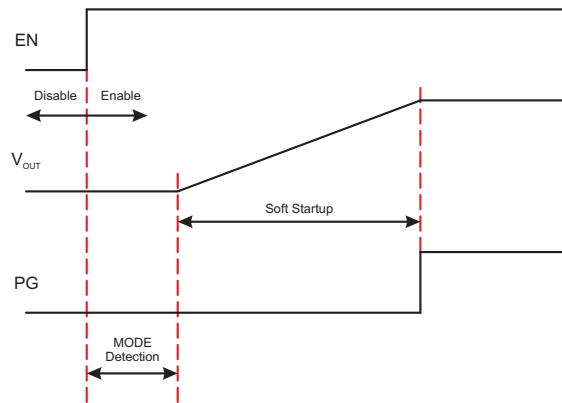

Figure 3. Power Up Sequence

Table 1. Switching Frequency and Mode Selection

Typical PWM Switching Frequency (MHz)	Resistance at MODE pin (E24 EIA Value)	Toggle MODE pin after MODE detection	ON-Time Equation	Operating Mode
1.50	8.2kΩ ±5%	No	$t_{ON} = 667ns \times V_{OUT} / V_{IN}$	Forced PWM
1.75	18kΩ ±5%	No	$t_{ON} = 571ns \times V_{OUT} / V_{IN}$	Forced PWM
2.00	AGND	Yes	$t_{ON} = 500ns \times V_{OUT} / V_{IN}$	PWM/PSM and Forced PWM
2.25	39kΩ ±5%	No	$t_{ON} = 444ns \times V_{OUT} / V_{IN}$	Forced PWM
2.50	75kΩ ±5% or Open	No	$t_{ON} = 400ns \times V_{OUT} / V_{IN}$	Forced PWM

Connecting the MODE pin to AGND with a resistor or leaving the MODE pin open forces the device into PWM mode for the whole load range. The device operates with a constant switching frequency that allows simple filtering of the switching frequency for noise sensitive applications. In forced PWM mode, the efficiency is lower than that of PSM at light load.

Connecting the MODE pin to the AGND pin enables Power Save Mode with an automatic transition between PWM and Power Save Mode. As the load current decreases and the inductor current becomes discontinuous, the device enters Power Save Mode operation automatically. In Power Save Mode, the switching frequency is reduced and estimated by Equation 2. In Power Save Mode, the output voltage rises slightly above the nominal output voltage, as shown in Figure 13. This effect is minimized by increasing the output capacitor.

$$f_{PSM} = \frac{2 \times I_{OUT}}{t_{ON}^2 \times \frac{V_{IN}}{V_{OUT}} \times \frac{V_{IN} - V_{OUT}}{L}} \tag{2}$$

When the device operates close to 100% duty cycle mode, the TPS62097-Q1 can't enter Power Save Mode regardless of the load current if the input voltage decreases to typically 15% above the output voltage. The device maintains output regulation in PWM mode.

7.4.3 Soft Startup (SS/TR)

The TPS62097-Q1 programs its output voltage ramp rate with the SS/TR pin. Connecting an external capacitor to SS/TR enables output soft startup to reduce inrush current from the input supply. The device charges the capacitor voltage to the input supply voltage with a constant current of typically 7.5µA. The FB pin voltage follows the SS/TR pin voltage until the internal reference voltage of 0.8V is reached. The soft startup time is calculated using Equation 3. Keep the SS/TR pin floating to set the minimum startup time.

$$t_{SS} = C_{SS/TR} \times \frac{0.8V}{7.5\mu A} \quad (3)$$

An active pull-down circuit is connected to the SS/TR pin. It discharges the external soft startup capacitor in case of disable, UVLO, thermal shutdown and HICCUP short circuit protection.

7.4.4 Voltage Tracking (SS/TR)

The SS/TR pin is externally driven by another voltage source to achieve output voltage tracking. The application circuit is shown in Figure 4. From 0 V to 0.8 V, the internal reference voltage to the internal error amplifier follows the SS/TR pin voltage. When the SS/TR pin voltage is above 0.8 V, the voltage tracking is disabled and the FB pin voltage is regulated at 0.8 V. The device achieves ratiometric or coincidental (simultaneous) output tracking, as shown in Figure 5.

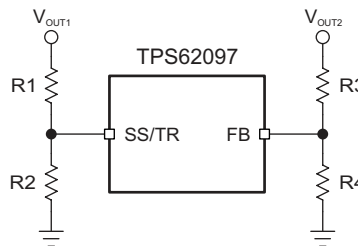

Figure 4. Output Voltage Tracking

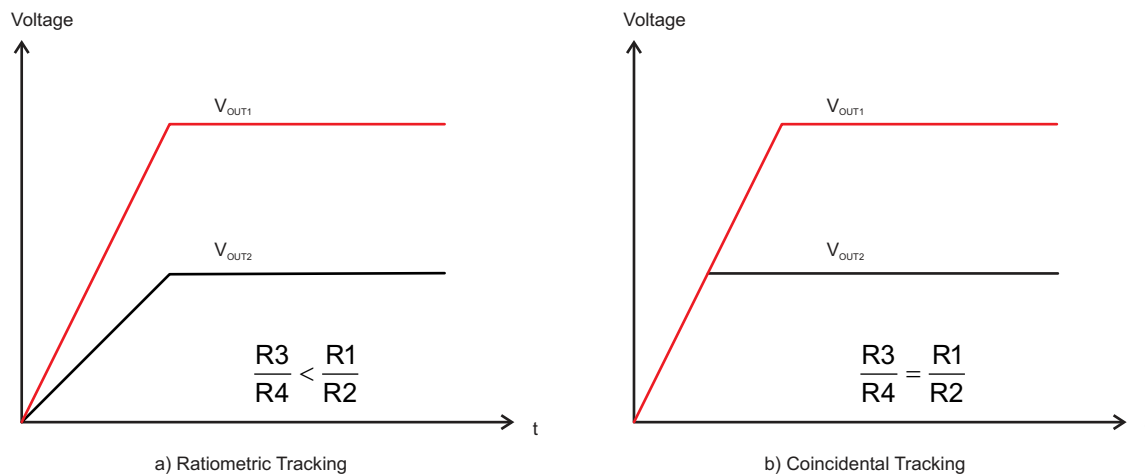

Figure 5. Voltage Tracking Options

The R2 value should be set properly to achieve accurate voltage tracking by taking 7.5 µA soft startup current into account. 1 kΩ or smaller is a sufficient value for R2.

For decreasing SS/TR pin voltage, the device doesn't sink current from the output when the device is in PSM. So the resulting decreases of the output voltage may be slower than the SS/TR pin voltage if the load is light. When driving the SS/TR pin with an external voltage, do not exceed the voltage rating of the SS/TR pin which is $V_{IN}+0.3V$.

7.4.5 Power Good (PG)

The TPS62097-Q1 has a power good output. The PG pin goes high impedance once the output voltage is above 95% of the nominal voltage, and is driven low once the output voltage falls below typically 90% of the nominal voltage. The PG pin is an open drain output and is specified to sink up to 1mA. The power good output requires a pull-up resistor connected to any voltage rail less than 6V. The PG signal can be used for sequencing of multiple rails by connecting it to the EN pin of other converters. Leave the PG pin floating when not used. [Table 2](#) shows the PG pin logic.

Table 2. PG Pin Logic

Device Conditions		Logic Status	
		High Z	Low
Enable	EN = High, $V_{FB} \geq V_{PG}$	√	
	EN = Low, $V_{FB} \leq V_{PG}$		√
Shutdown	EN = Low		√
Thermal Shutdown	$T_J > T_{JSD}$		√
UVLO	$0.7\text{ V} < V_{IN} < V_{UVLO}$		√
Power Supply Removal	$V_{IN} \leq 0.7\text{ V}$	√	

8 Application Information

NOTE

Information in the following applications sections is not part of the TI component specification, and TI does not warrant its accuracy or completeness. TI's customers are responsible for determining suitability of components for their purposes. Customers should validate and test their design implementation to confirm system functionality.

8.1 Application Information

The following section discusses the design of the external components to complete the power supply design of the TPS62097-Q1.

8.2 1.8-V Output Application

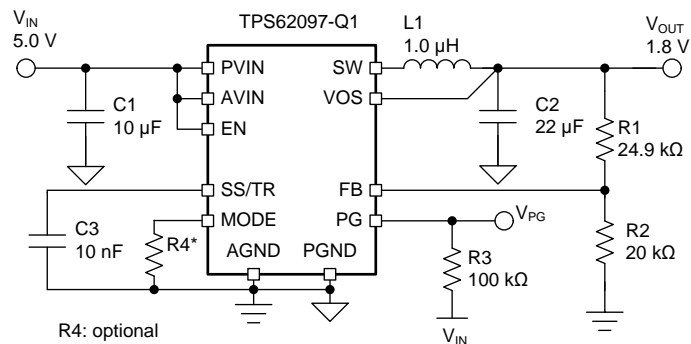

Copyright © 2016, Texas Instruments Incorporated

Figure 6. 1.8-V Output Application Schematic

8.2.1 Design Requirements

For this design example, use the following as the input parameters.

Table 3. Design Parameters

DESIGN PARAMETER	EXAMPLE VALUE
Input voltage range	2.5 V to 6 V
Output voltage	1.8 V
Output current	2.0 A

Table 4 lists the components used for the example.

Table 4. List of Components

REFERENCE	DESCRIPTION	MANUFACTURER ⁽¹⁾
C1	10 µF, Ceramic Capacitor, 6.3V, X7R, size 0805, C2012X7R0J106M125AB	TDK
C2	22 µF, Ceramic Capacitor, 6.3V, X7S, size 0805, C2012X7S1A226M125AC	TDK
C3	10 nF, Ceramic Capacitor, 6.3V, X7R, size 0603, GRM188R70J103KA01	Murata
L1	1 µH, Shielded, 5.4A, XFL4020-102MEB	Coilcraft
R1	Depending on the output voltage, 1% accuracy	Std
R2	20 kΩ, 1% accuracy	Std
R3	100 kΩ, 1% accuracy	Std

(1) See [Third-party Products Disclaimer](#)

8.2.2 Detailed Design Procedure

8.2.2.1 Setting the Output Voltage

The output voltage is set by an external resistor divider according to the following equation:

$$V_{OUT} = V_{FB} \times \left(1 + \frac{R1}{R2}\right) = 0.8 \text{ V} \times \left(1 + \frac{R1}{R2}\right) \quad (4)$$

R2 should not be higher than 20 kΩ to reduce noise coupling into the FB pin and improve the output voltage regulation. Choose additional resistor values for other outputs. A feed forward capacitor is not required.

The fixed output voltage version, TPS6209733-Q1, does not need an external resistor divider. TI recommends to connect the FB pin to AGND for improved thermal performance.

8.2.2.2 Output Filter Design

The inductor and the output capacitor together provide a low-pass filter. To simplify the selection process, [Table 5](#) outlines possible inductor and capacitor value combinations for most applications.

Table 5. Output Capacitor / Inductor Combinations

NOMINAL L [μH] ⁽¹⁾	NOMINAL C _{OUT} [μF] ⁽²⁾				
	10	22	47	100	150
0.47					
1		+(3)	+	+	+
2.2					

- (1) Inductor tolerance and current de-rating is anticipated. The effective inductance can vary by +20% and -30%. The required effective inductance is 500nH minimum.
- (2) Capacitance tolerance and bias voltage de-rating is anticipated. The effective capacitance can vary by 20% and -50%.
- (3) Typical application configuration. Other '+' mark indicates recommended filter combinations. Other values may be acceptable in applications but should be fully tested by the user. Refer to the application note [SLVA710](#).

8.2.2.3 Inductor Selection

The main parameters for the inductor selection are the inductor value and the saturation current. To calculate the maximum inductor current under static load conditions, [Equation 5](#) is given.

$$I_{L,MAX} = I_{OUT,MAX} + \frac{\Delta I_L}{2}$$

$$\Delta I_L = V_{OUT} \times \frac{1 - \frac{V_{OUT}}{V_{IN}}}{L \times f_{SW}} \quad (5)$$

Where:

- I_{OUT,MAX} = Maximum output current
- ΔI_L = Inductor current ripple
- f_{SW} = Switching frequency
- L = Inductor value

TI recommends to choose the saturation current for the inductor 20% to 30% higher than the I_{L,MAX}, out of [Equation 5](#). A higher inductor value is also useful to lower ripple current but increases the transient response time as well.

8.2.2.4 Capacitor Selection

The input capacitor is the low impedance energy source for the converters which helps to provide stable operation. A low ESR multilayer ceramic capacitor is required for best filtering and should be placed between PVIN and PGND as close as possible to those pins. For most applications a 10-μF capacitor is sufficient, though a larger value reduces input current ripple.

The architecture of the TPS62097-Q1 allows the use of tiny ceramic output capacitors with low equivalent series resistance (ESR). These capacitors provide low output voltage ripple and are recommended. To keep its low resistance up to high frequencies and to get narrow capacitance variation with temperature, TI recommends to use X7R or X5R dielectrics. The recommended typical output capacitor value is 22 μF and can vary over a wide range as outlined in [Table 5](#).

Ceramic capacitors have a DC-Bias effect, which has a strong influence on the final effective capacitance. Choose the right capacitor carefully in combination with considering its package size and voltage rating. Ensure that the input effective capacitance is at least 5 μF and the output effective capacitance is at least 10 μF .

8.2.3 Application Performance Curves

$T_A = 25^\circ\text{C}$, BOM = [Table 4](#) unless otherwise noted.

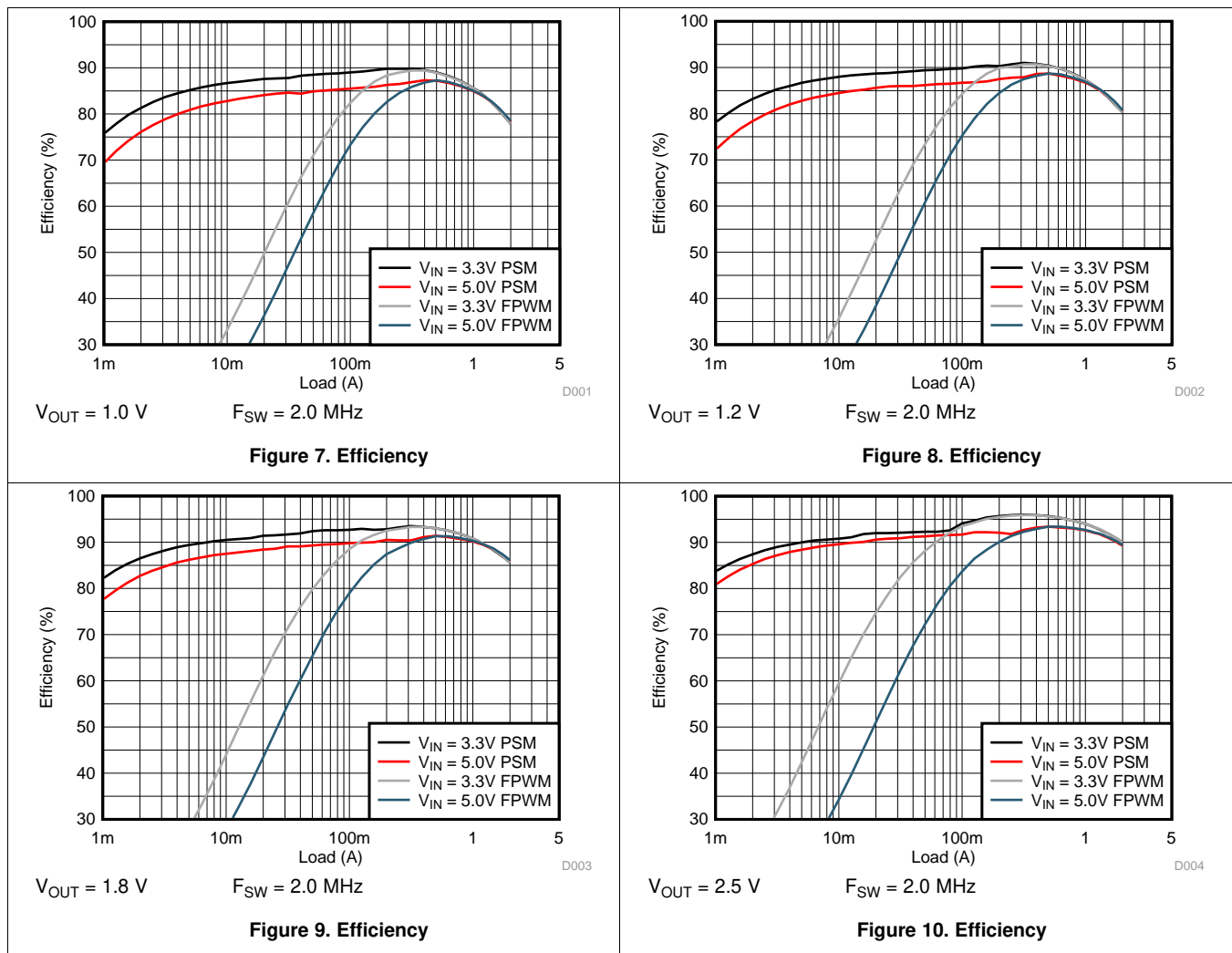

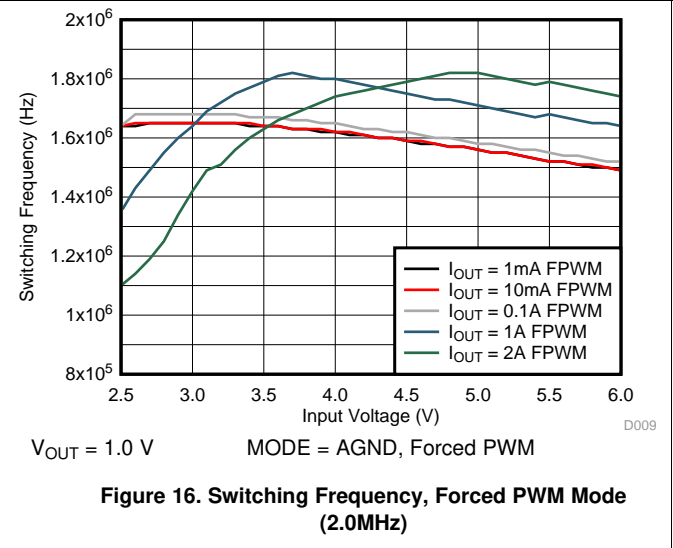
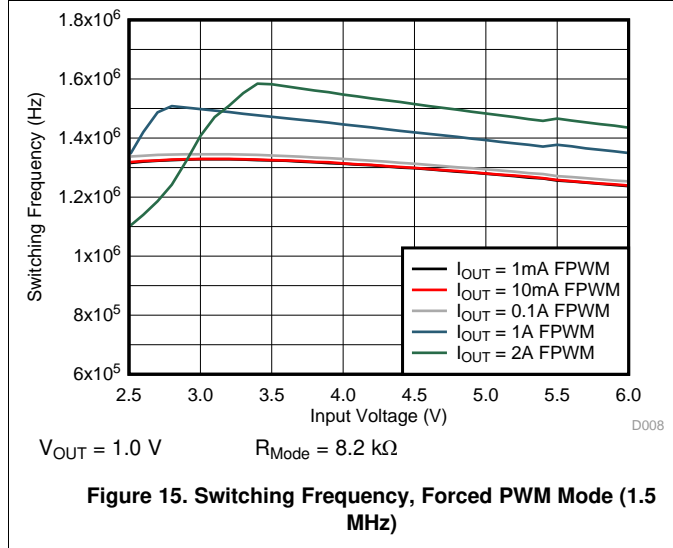
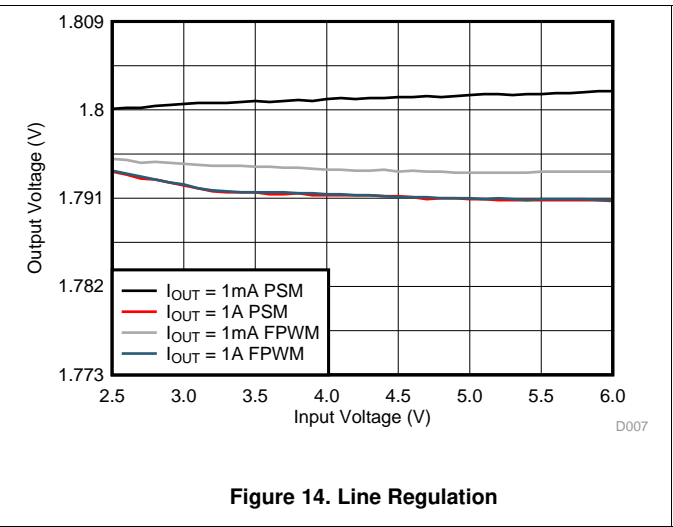
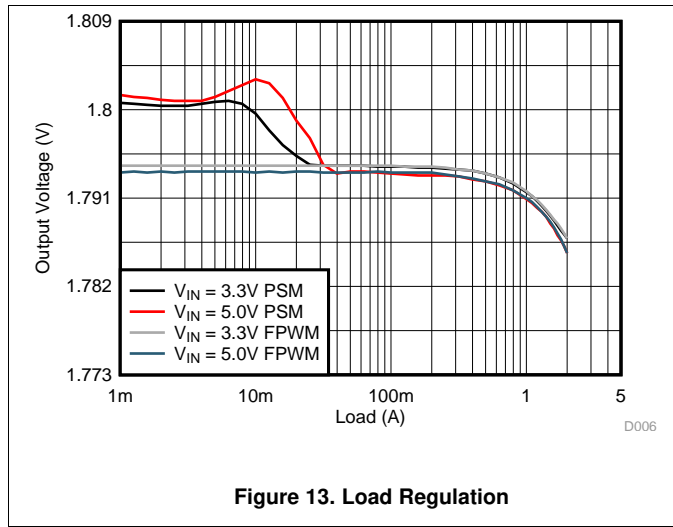
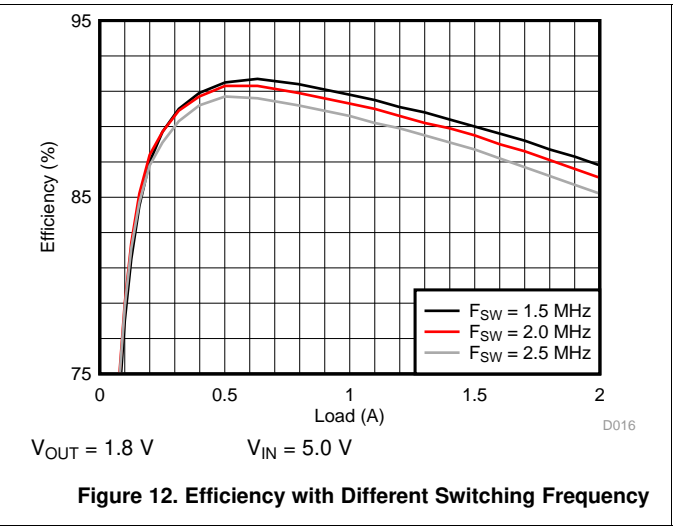
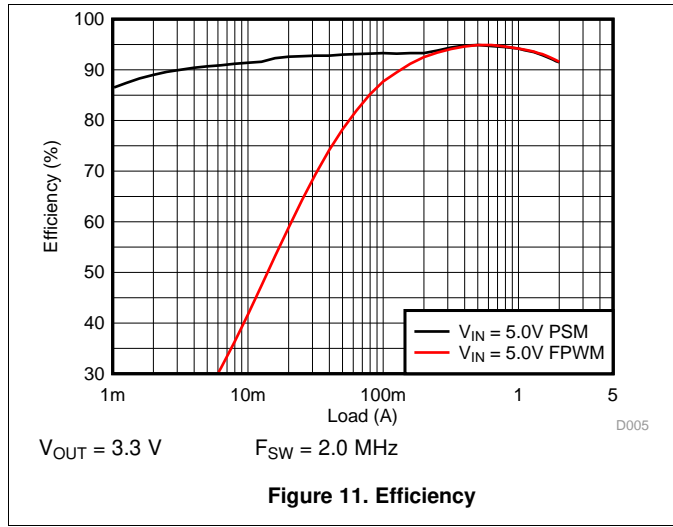

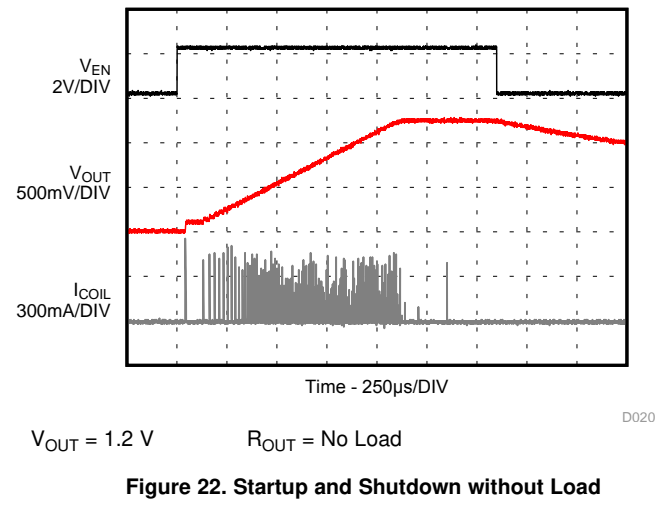
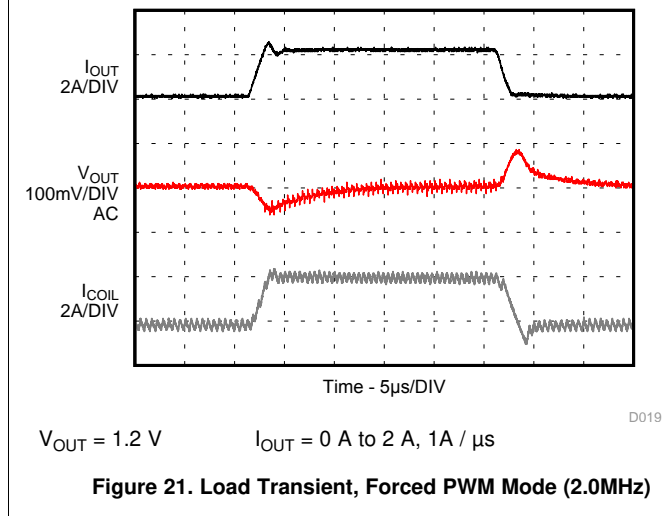
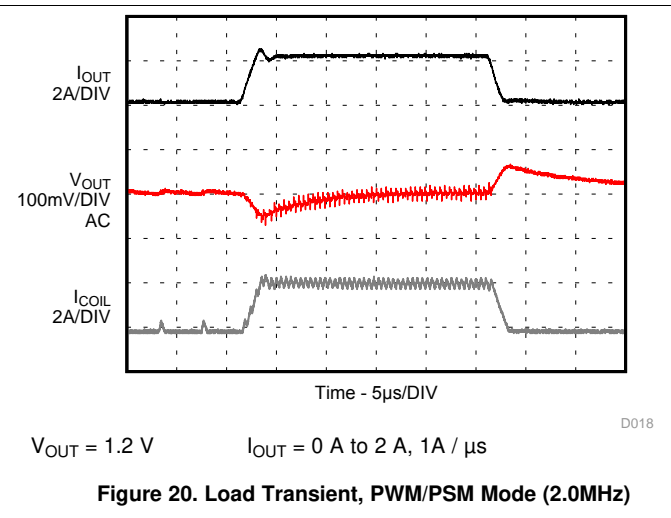
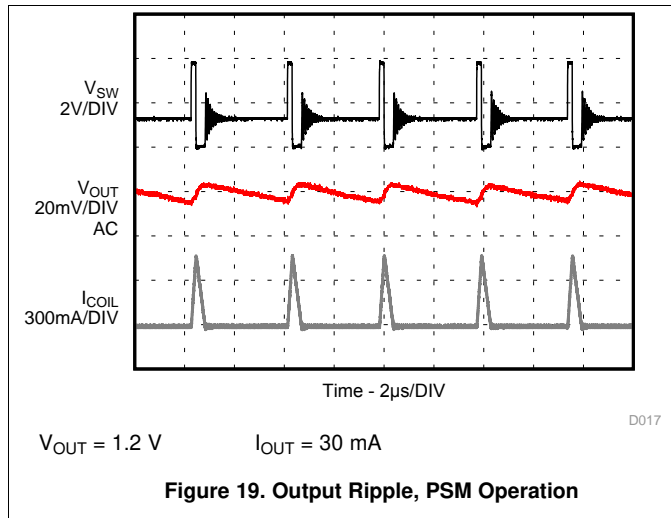
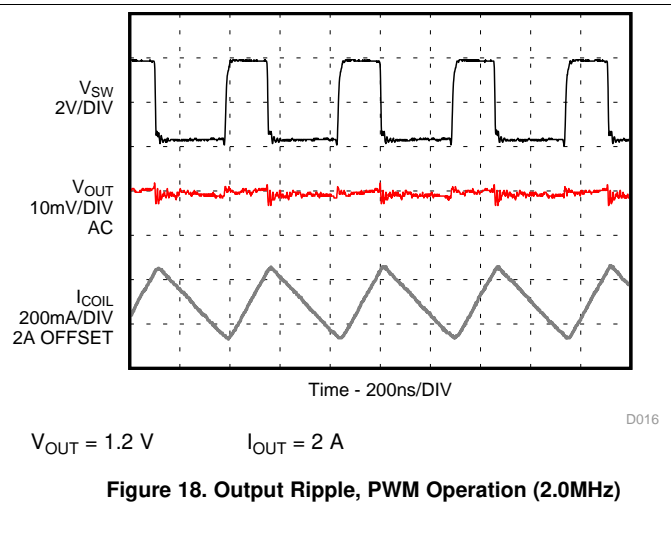
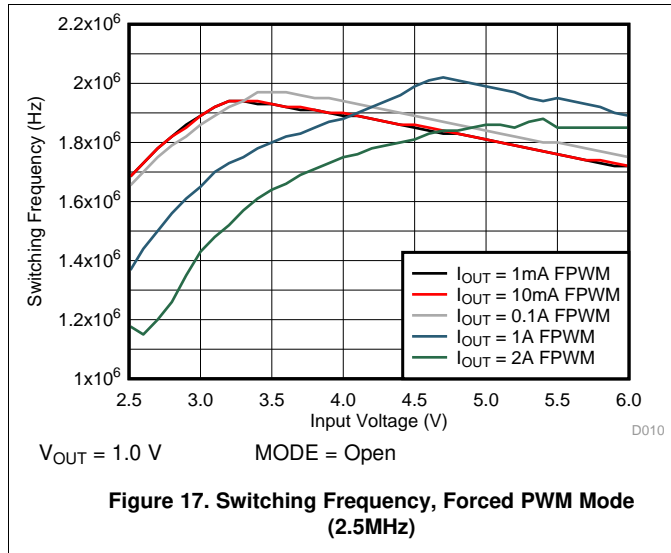

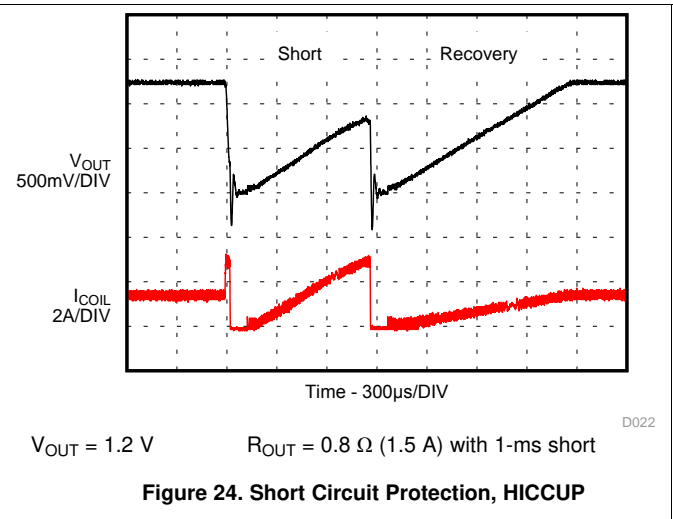
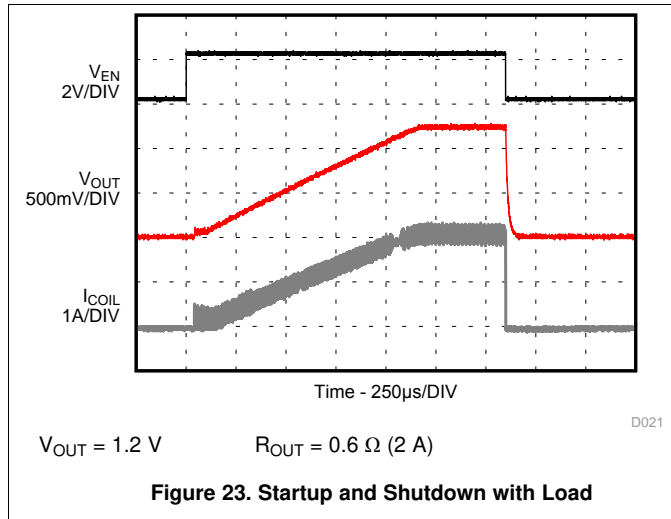

9 Power Supply Recommendations

The devices are designed to operate from an input voltage supply range between 2.5V and 6V. The average input current of the TPS62097-Q1 is calculated as:

$$I_{IN} = \frac{1}{\eta} \times \frac{V_{OUT} \times I_{OUT}}{V_{IN}} \quad (6)$$

Ensure that the power supply has a sufficient current rating for the application.

10 PCB Layout

10.1 Layout Guidelines

- TI recommends to place all components as close as possible to the IC. Specially, the input capacitor placement must be closest to the PVIN and PGND pins of the device.
- The low side of the input and output capacitors must be connected directly to the PGND pin to avoid a ground potential shift.
- Use wide and short traces for the main current paths to reduce the parasitic inductance and resistance.
- The sense trace connected to VOS pin is a signal trace. Special care should be taken to avoid noise being induced. Keep the trace away from SW nodes.
- Refer to [Figure 25](#) for an example of component placement, routing and thermal design.

10.2 Layout Example

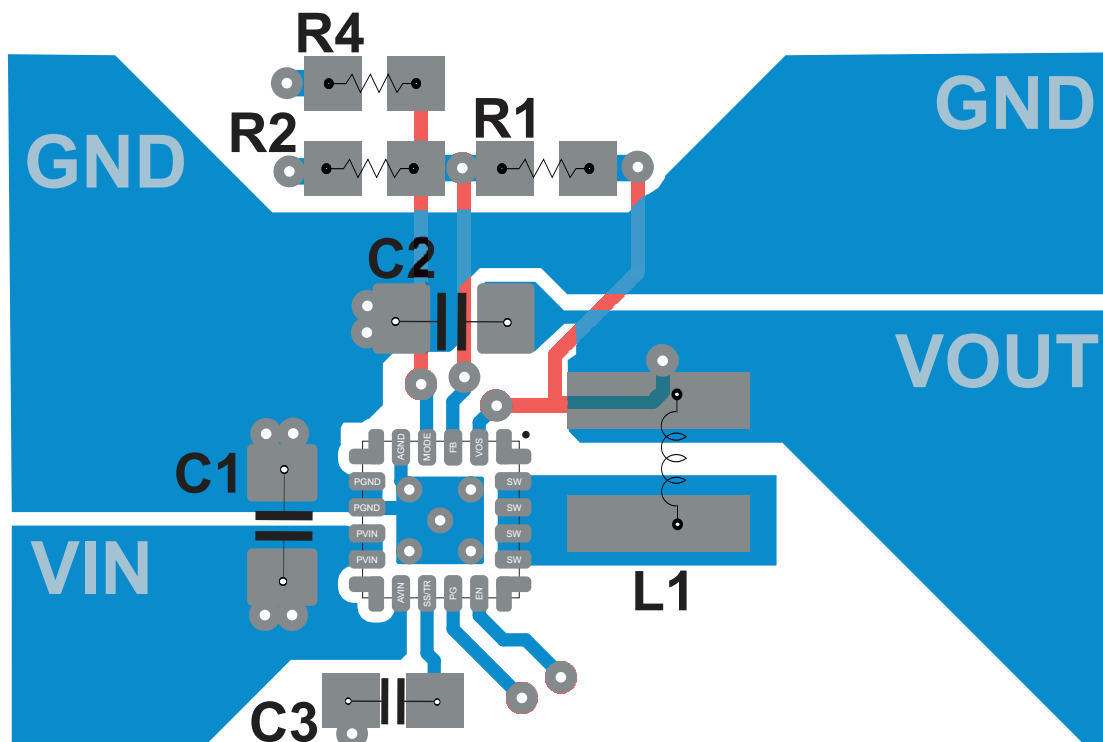

Figure 25. TPS62097-Q1 PCB Layout

10.3 Thermal Information

Implementation of integrated circuits in low-profile and fine pitch surface mount packages typically requires special attention to power dissipation. Many system dependent issues such as thermal coupling, airflow, added heat sinks and convection surfaces, and the presence of other heat-generating components affect the power-dissipation limits of a given component. For more details on how to use the thermal parameters, see the application notes: Thermal Characteristics Application Notes [SZZA017](#) and [SPRA953](#).

11 Device and Documentation Support

11.1 Device Support

11.1.1 Third-Party Products Disclaimer

TI'S PUBLICATION OF INFORMATION REGARDING THIRD-PARTY PRODUCTS OR SERVICES DOES NOT CONSTITUTE AN ENDORSEMENT REGARDING THE SUITABILITY OF SUCH PRODUCTS OR SERVICES OR A WARRANTY, REPRESENTATION OR ENDORSEMENT OF SUCH PRODUCTS OR SERVICES, EITHER ALONE OR IN COMBINATION WITH ANY TI PRODUCT OR SERVICE.

11.2 Community Resources

The following links connect to TI community resources. Linked contents are provided "AS IS" by the respective contributors. They do not constitute TI specifications and do not necessarily reflect TI's views; see TI's [Terms of Use](#).

TI E2E™ Online Community *TI's Engineer-to-Engineer (E2E) Community*. Created to foster collaboration among engineers. At e2e.ti.com, you can ask questions, share knowledge, explore ideas and help solve problems with fellow engineers.

Design Support *TI's Design Support* Quickly find helpful E2E forums along with design support tools and contact information for technical support.

11.3 Trademarks

E2E is a trademark of Texas Instruments.
All other trademarks are the property of their respective owners.

11.4 Electrostatic Discharge Caution



These devices have limited built-in ESD protection. The leads should be shorted together or the device placed in conductive foam during storage or handling to prevent electrostatic damage to the MOS gates.

11.5 Glossary

[SLYZ022](#) — *TI Glossary*.

This glossary lists and explains terms, acronyms, and definitions.

12 Mechanical, Packaging, and Orderable Information

The following pages include mechanical, packaging, and orderable information. This information is the most current data available for the designated devices. This data is subject to change without notice and revision of this document. For browser-based versions of this data sheet, refer to the left-hand navigation.

PACKAGING INFORMATION

Orderable Device	Status (1)	Package Type	Package Drawing	Pins	Package Qty	Eco Plan (2)	Lead finish/ Ball material (6)	MSL Peak Temp (3)	Op Temp (°C)	Device Marking (4/5)	Samples
TPS6209733QWRGTRQ1	ACTIVE	VQFN	RGT	16	3000	RoHS & Green	SN	Level-2-260C-1 YEAR	-40 to 125	9733Q	Samples
TPS62097QWRGTRQ1	ACTIVE	VQFN	RGT	16	3000	RoHS & Green	SN	Level-2-260C-1 YEAR	-40 to 125	9700Q	Samples

(1) The marketing status values are defined as follows:

ACTIVE: Product device recommended for new designs.

LIFEBUY: TI has announced that the device will be discontinued, and a lifetime-buy period is in effect.

NRND: Not recommended for new designs. Device is in production to support existing customers, but TI does not recommend using this part in a new design.

PREVIEW: Device has been announced but is not in production. Samples may or may not be available.

OBSOLETE: TI has discontinued the production of the device.

(2) **RoHS:** TI defines "RoHS" to mean semiconductor products that are compliant with the current EU RoHS requirements for all 10 RoHS substances, including the requirement that RoHS substance do not exceed 0.1% by weight in homogeneous materials. Where designed to be soldered at high temperatures, "RoHS" products are suitable for use in specified lead-free processes. TI may reference these types of products as "Pb-Free".

RoHS Exempt: TI defines "RoHS Exempt" to mean products that contain lead but are compliant with EU RoHS pursuant to a specific EU RoHS exemption.

Green: TI defines "Green" to mean the content of Chlorine (Cl) and Bromine (Br) based flame retardants meet JS709B low halogen requirements of <=1000ppm threshold. Antimony trioxide based flame retardants must also meet the <=1000ppm threshold requirement.

(3) MSL, Peak Temp. - The Moisture Sensitivity Level rating according to the JEDEC industry standard classifications, and peak solder temperature.

(4) There may be additional marking, which relates to the logo, the lot trace code information, or the environmental category on the device.

(5) Multiple Device Markings will be inside parentheses. Only one Device Marking contained in parentheses and separated by a "~" will appear on a device. If a line is indented then it is a continuation of the previous line and the two combined represent the entire Device Marking for that device.

(6) Lead finish/Ball material - Orderable Devices may have multiple material finish options. Finish options are separated by a vertical ruled line. Lead finish/Ball material values may wrap to two lines if the finish value exceeds the maximum column width.

Important Information and Disclaimer:The information provided on this page represents TI's knowledge and belief as of the date that it is provided. TI bases its knowledge and belief on information provided by third parties, and makes no representation or warranty as to the accuracy of such information. Efforts are underway to better integrate information from third parties. TI has taken and continues to take reasonable steps to provide representative and accurate information but may not have conducted destructive testing or chemical analysis on incoming materials and chemicals. TI and TI suppliers consider certain information to be proprietary, and thus CAS numbers and other limited information may not be available for release.

In no event shall TI's liability arising out of such information exceed the total purchase price of the TI part(s) at issue in this document sold by TI to Customer on an annual basis.

OTHER QUALIFIED VERSIONS OF TPS62097-Q1 :

- Catalog: [TPS62097](#)

NOTE: Qualified Version Definitions:

- Catalog - TI's standard catalog product

TAPE AND REEL INFORMATION

QUADRANT ASSIGNMENTS FOR PIN 1 ORIENTATION IN TAPE

*All dimensions are nominal

Device	Package Type	Package Drawing	Pins	SPQ	Reel Diameter (mm)	Reel Width W1 (mm)	A0 (mm)	B0 (mm)	K0 (mm)	P1 (mm)	W (mm)	Pin1 Quadrant
TPS6209733QWRGTRQ1	VQFN	RGT	16	3000	330.0	12.4	3.3	3.3	1.0	8.0	12.0	Q2
TPS62097QWRGTRQ1	VQFN	RGT	16	3000	330.0	12.4	3.3	3.3	1.0	8.0	12.0	Q2

TAPE AND REEL BOX DIMENSIONS

*All dimensions are nominal

Device	Package Type	Package Drawing	Pins	SPQ	Length (mm)	Width (mm)	Height (mm)
TPS6209733QWRGTRQ1	VQFN	RGT	16	3000	367.0	367.0	38.0
TPS62097QWRGTRQ1	VQFN	RGT	16	3000	367.0	367.0	38.0

RGT 16

GENERIC PACKAGE VIEW

VQFN - 1 mm max height

PLASTIC QUAD FLATPACK - NO LEAD

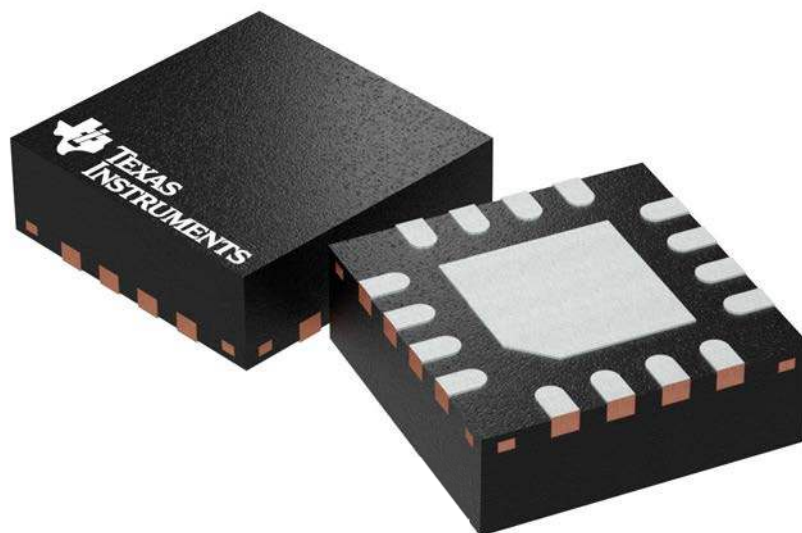

Images above are just a representation of the package family, actual package may vary.
Refer to the product data sheet for package details.

4203495/1

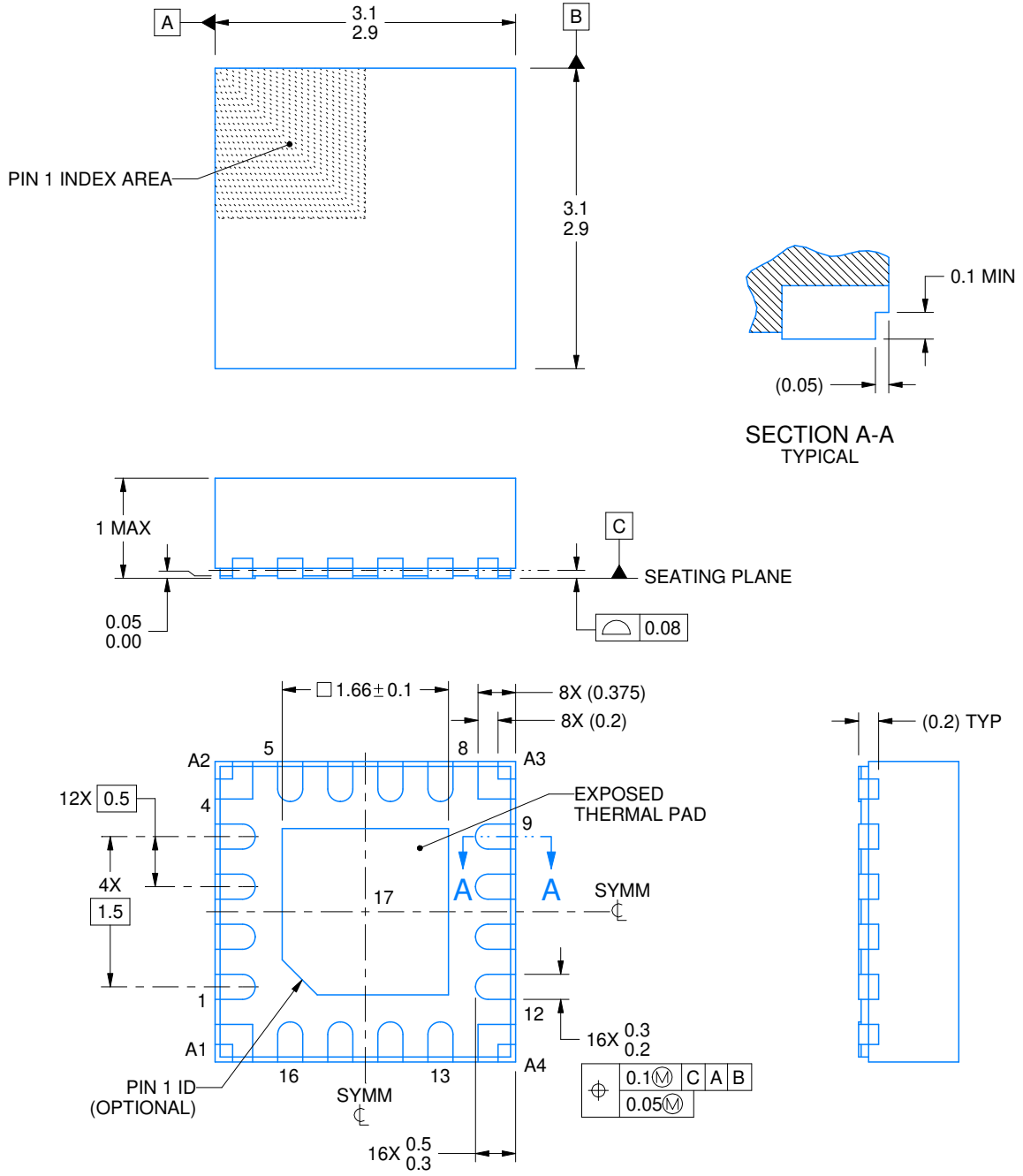

4223569/C 03/2020

NOTES:

1. All linear dimensions are in millimeters. Any dimensions in parenthesis are for reference only. Dimensioning and tolerancing per ASME Y14.5M.
2. This drawing is subject to change without notice.
3. The package thermal pad must be soldered to the printed circuit board for thermal and mechanical performance.

EXAMPLE BOARD LAYOUT

RGT0016H

VQFN - 1 mm max height

PLASTIC QUAD FLATPACK - NO LEAD

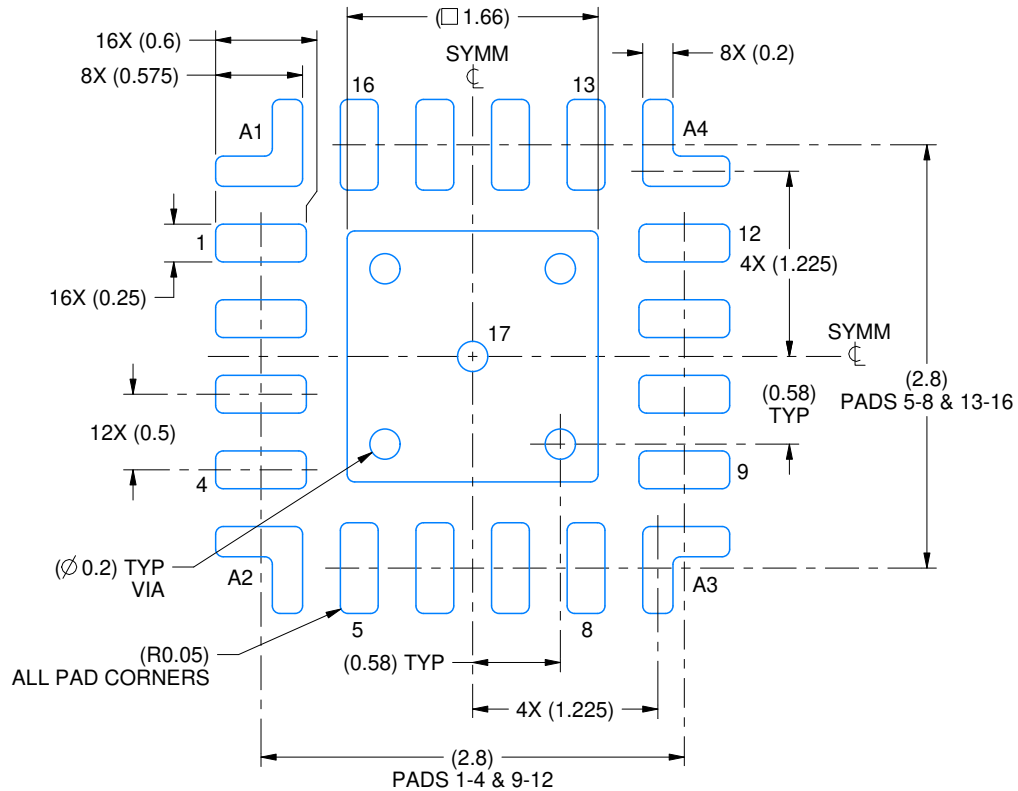

LAND PATTERN EXAMPLE
EXPOSED METAL SHOWN
SCALE:20X

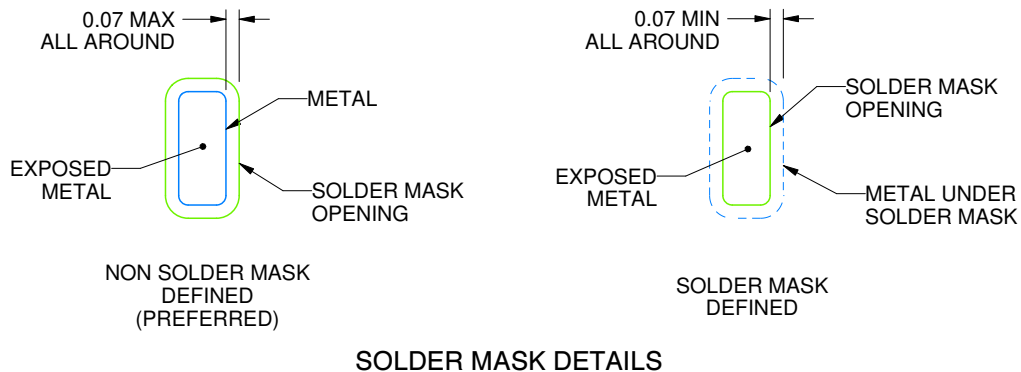

SOLDER MASK DETAILS

4223569/C 03/2020

NOTES: (continued)

- This package is designed to be soldered to a thermal pad on the board. For more information, see Texas Instruments literature number SLUA271 (www.ti.com/lit/sluea271).
- Vias are optional depending on application, refer to device data sheet. If any vias are implemented, refer to their locations shown on this view. It is recommended that vias under paste be filled, plugged or tented.

EXAMPLE STENCIL DESIGN

RGT0016H

VQFN - 1 mm max height

PLASTIC QUAD FLATPACK - NO LEAD

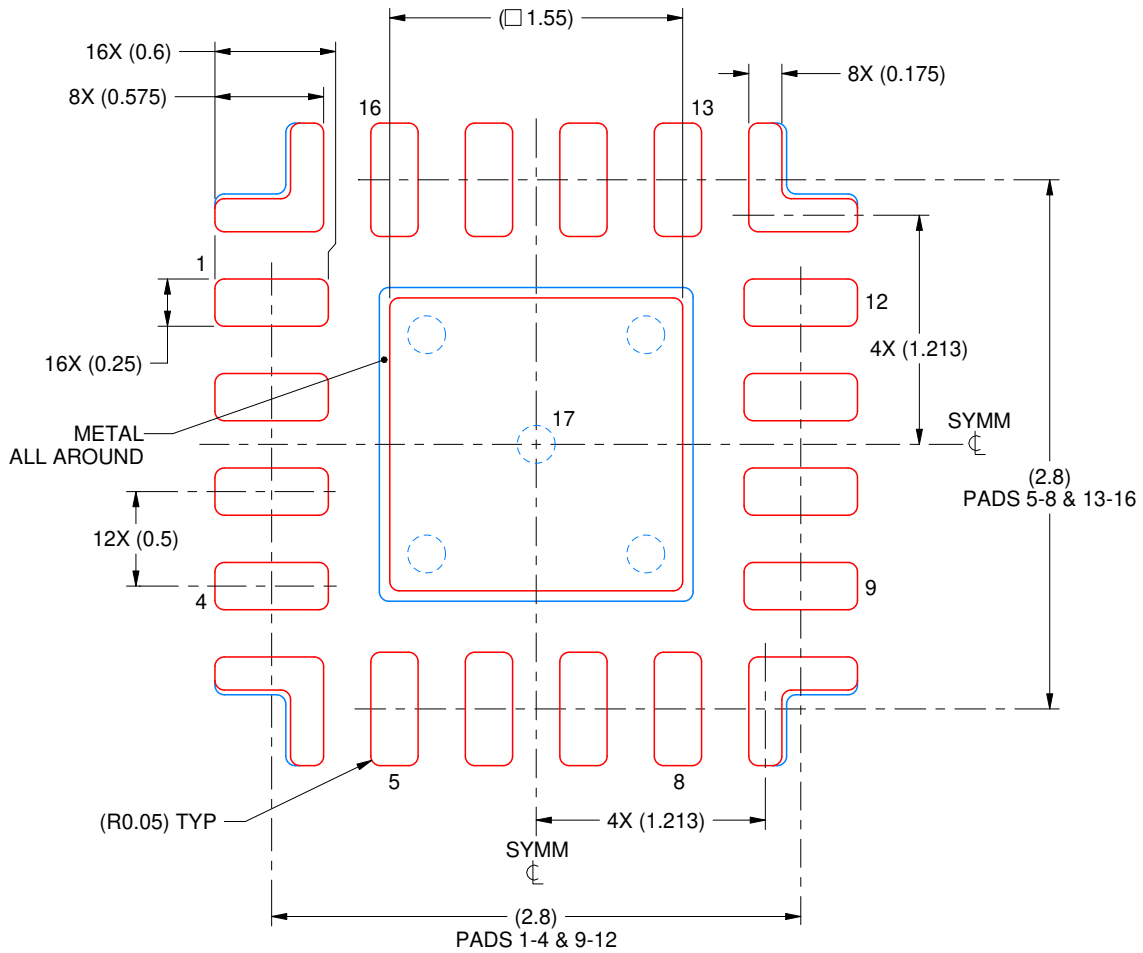

SOLDER PASTE EXAMPLE BASED ON 0.1 mm THICK STENCIL

PRINTED SOLDER COVERAGE BY AREA UNDER PACKAGE
THERMAL PAD 17: 87% - PADS A1, A2, A3, & A4: 89%
SCALE:25X

4223569/C 03/2020

NOTES: (continued)

6. Laser cutting apertures with trapezoidal walls and rounded corners may offer better paste release. IPC-7525 may have alternate design recommendations.

IMPORTANT NOTICE AND DISCLAIMER

TI PROVIDES TECHNICAL AND RELIABILITY DATA (INCLUDING DATASHEETS), DESIGN RESOURCES (INCLUDING REFERENCE DESIGNS), APPLICATION OR OTHER DESIGN ADVICE, WEB TOOLS, SAFETY INFORMATION, AND OTHER RESOURCES "AS IS" AND WITH ALL FAULTS, AND DISCLAIMS ALL WARRANTIES, EXPRESS AND IMPLIED, INCLUDING WITHOUT LIMITATION ANY IMPLIED WARRANTIES OF MERCHANTABILITY, FITNESS FOR A PARTICULAR PURPOSE OR NON-INFRINGEMENT OF THIRD PARTY INTELLECTUAL PROPERTY RIGHTS.

These resources are intended for skilled developers designing with TI products. You are solely responsible for (1) selecting the appropriate TI products for your application, (2) designing, validating and testing your application, and (3) ensuring your application meets applicable standards, and any other safety, security, or other requirements. These resources are subject to change without notice. TI grants you permission to use these resources only for development of an application that uses the TI products described in the resource. Other reproduction and display of these resources is prohibited. No license is granted to any other TI intellectual property right or to any third party intellectual property right. TI disclaims responsibility for, and you will fully indemnify TI and its representatives against, any claims, damages, costs, losses, and liabilities arising out of your use of these resources.

TI's products are provided subject to TI's Terms of Sale (<https://www.ti.com/legal/termsofsale.html>) or other applicable terms available either on [ti.com](https://www.ti.com) or provided in conjunction with such TI products. TI's provision of these resources does not expand or otherwise alter TI's applicable warranties or warranty disclaimers for TI products.

Mailing Address: Texas Instruments, Post Office Box 655303, Dallas, Texas 75265
Copyright © 2021, Texas Instruments Incorporated