

# General Specifications

Toggles

Rockers  
B

Pushbuttons

Illuminated PB

Programmable

Keylocks

Rotaries

Slides

Tactiles

Tilt

Touch

Indicators

Accessories

Supplement

## Electrical Capacity (Resistive Load)

Power Level: 9A @ 125V AC

## Other Ratings

**Contact Resistance:** 20 milliohms maximum

**Insulation Resistance:** 500 megohms minimum @ 500V DC

**Dielectric Strength:** 1,500V AC minimum between contacts for 1 minute minimum;  
3,000V AC minimum between contacts & case for 1 minute minimum

**Mechanical Life:** 30,000 operations minimum

**Electrical Life:** 10,000 operations minimum

**Nominal Operating Force:** 10.0N

**Angle of Throw:** 30°

## Materials & Finishes

**Rocker:** Polycarbonate

**Housing:** Polyamide

**Movable Contact:** Beryllium copper with silver plating

**Movable Contacts:** Silver alloy

**Stationary Contacts:** Silver alloy

**Switch Terminals:** Brass with silver plating

**Lamp Terminals:** Brass with silver plating

## Environmental Data

**Operating Temp Range:** -20°C through +85°C (-4°F through +185°F)

**Humidity:** 90 ~ 95% humidity for 96 hours @ 40°C (104°F)

**Vibration:** 10 ~ 55Hz with peak-to-peak amplitude of 0.75mm traversing the frequency range  
& returning in 1 minute; 3 right angled directions for 2 hours

**Shock:** 50G (490m/s<sup>2</sup>) acceleration (tested in 6 right angled directions, with 5 shocks in each direction)

## Standards & Certifications

**UL:** File No. E44145  
9A @ 125V AC  
Markings on case are standard.

**CSA:** File No. 0701166\_0\_000  
9A @ 125V AC  
Markings on case are standard.

# Distinctive Characteristics

Full face, Neon illumination in choice of red, amber, or green.

Neon lamp suited to 125V AC applications.

9-amp electrical capacity in compact body.

Built-in resistor for direct connection to 125V AC power source.

Low cost molded rocker.

Front panel, snap-in mounting assures labor-saving installation.

Single-break, snap-acting contact mechanism gives smooth actuation and audible feedback.

Quick-make, quick-break characteristic limits arcing and prolongs electrical life.

Stable stationary contact construction for high reliability.

Offset terminal alignment gives outstanding insulation resistance and dielectric strength.

Quick connect terminals (.187"/4.75mm) can be used with connectors.



Actual Size

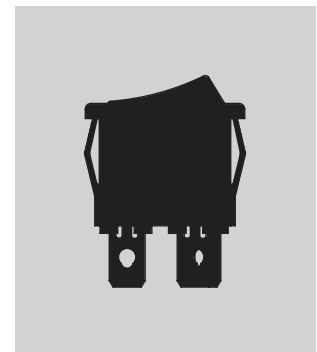

- Toggles
- B** Rockers
- Pushbuttons
- Programmable Illuminated PB
- Keylocks
- Rotaries
- Slides
- Tactiles
- Tilt
- Touch
- Indicators
- Accessories
- Supplement

### TYPICAL SWITCH ORDERING EXAMPLE

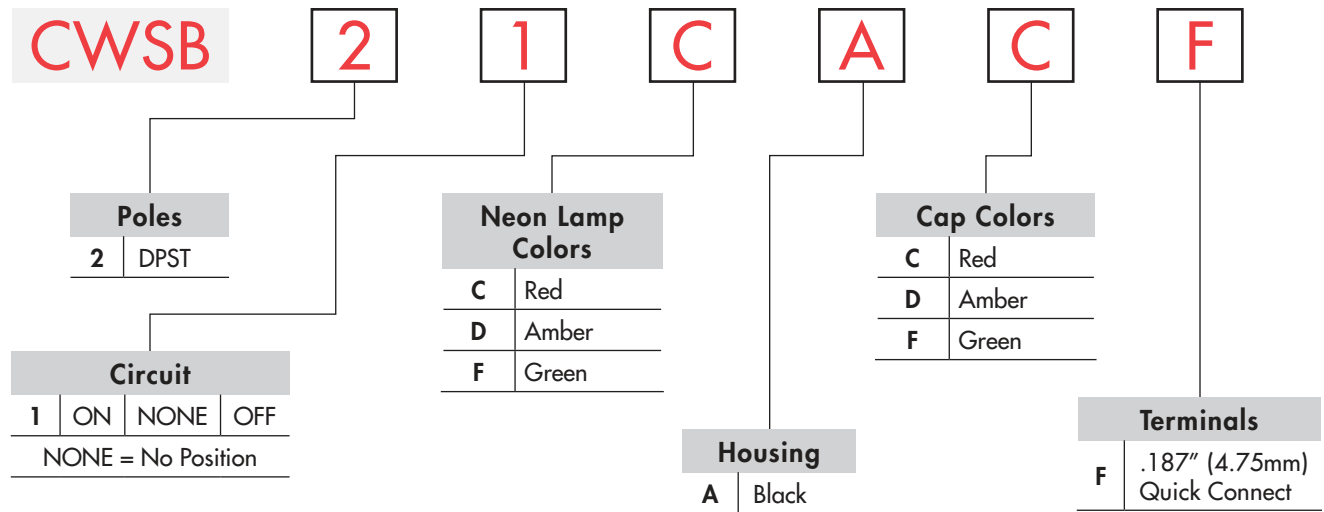

#### IMPORTANT:



Switches are supplied with UL & CSA markings on the case. Specific models & ratings noted on the General Specifications page.

#### DESCRIPTION FOR TYPICAL ORDERING EXAMPLE

**CWSB21CACF**

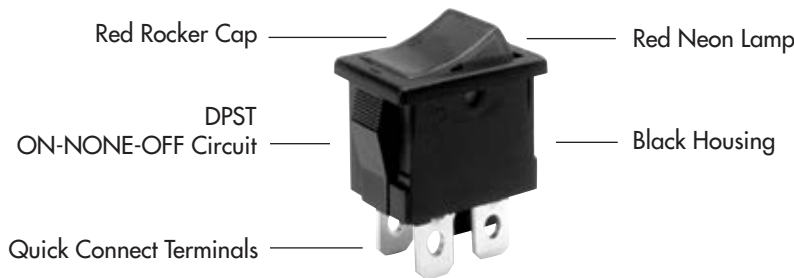

### POLE & CIRCUIT

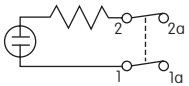
Pole	Model	Rocker Position NONE = No Position			Connected Terminals			Throw & Switch/Lamp Schematic
		Down	Center	Up	Down	Center	Up	
DP	CWSB21	ON	NONE	OFF	1-1a 2-2a	OPEN	OPEN	DPST 

Note: Terminal numbers "1a" and "2a" are actually on the switch.

## NEON LAMP COLORS & SPECIFICATIONS

The Neon lamp is factory assembled and not available separately. The lamp circuit is synchronous to switching circuit.

The electrical specifications shown are determined at a basic temperature of 25°C.

Values for the built-in resistors are given in the accompanying table.

		Colors		
		<b>C</b> Red	<b>D</b> Amber	<b>F</b> Green
Voltage	V	125V AC	125V AC	125V AC
Internal Series Resistance		33K ohms	33K ohms	68K ohms
Current	I	1.4mA	1.4mA	0.6mA
Endurance	Hours	15,000	15,000	8,000

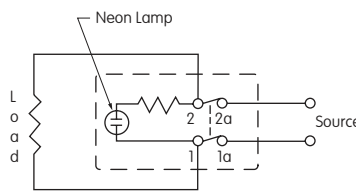

## HOUSING

**A** Black Housing with Snap-in Mounting

On Off (I O) symbols are molded on the bezel.



## TERMINALS

**F** .187" (4.75mm) Quick Connect

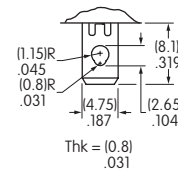

## CAP COLOR CODES

Cap Colors Available

**C** Red    **D** Amber    **F** Green



Caps are factory assembled and are not available separately.

## TYPICAL SWITCH DIMENSIONS

Double Pole

Neon Illuminated

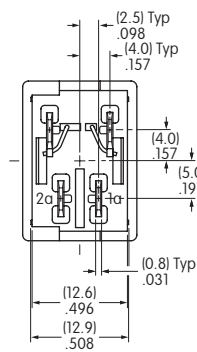
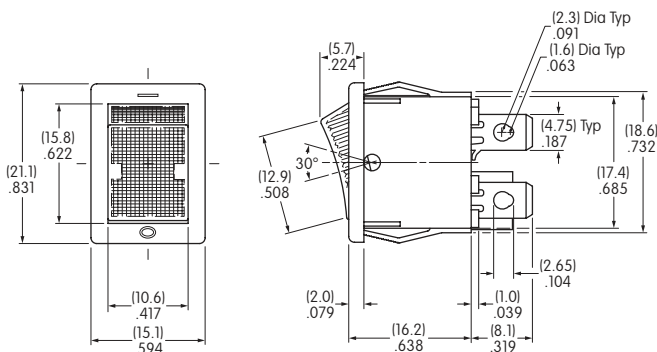

Panel Thickness  
.030" ~ .079"  
(0.75mm ~ 2.0mm)



CWSB21CACF

Toggles  
Rockers  
Pushbuttons  
Illuminated PB  
Programmable  
Keylocks  
Rotaries  
Slides  
Tactiles  
Tilt  
Touch  
Indicators  
Accessories  
Supplement