



# EN29A0QI 10A Power Module

## Step-Down DC-DC Switching Converter with Integrated Inductor

### DESCRIPTION

The EN29A0QI is a member of the EN2900 family of PowerSoCs optimized for powering noise sensitive loads which require tight DC and AC tolerance such as transceiver, high speed IO, and RF. PowerSoC devices integrate the controller, MOSFETS, inductor, and high frequency bypass capacitors to provide a low noise, low ripple, easy to use power conversion solution.

The EN29A0QI offers very tight DC accuracy combined with remote ground sense to meet the challenging tolerance requirements for high speed transceivers. The inductor is sized to provide very low output switching ripple while the package is designed for low EMI. The loop topology is based on low impedance voltage mode control combined with a high-performance error amplifier for excellent transient performance. The wide bandwidth loop, combined with the low impedance voltage mode control can enable a significant reduction of expensive bulk decoupling capacitors.

The EN29A0QI features a bidirectional SYNC pin which enables synchronization from an external clock, or can provide a master clock output. Other features include precision enable threshold, glitch free startup into a pre-biased load, and programmable soft-start and soft-shutdown.

### FEATURES

- Very low noise and ripple for transceiver power
- High accuracy VREF: 1% over Line, Load, Temp
- Remote ground sense for tight POL regulation
- Optimized for powering VCCR, VCCT, and VCCH
- High efficiency;  $V_{IN}=12V$ ,  $V_{OUT}=1.0V$ ; 86.5% @10A
- 10A continuous output current with no derating
- Wide input voltage range (9V to 16V)
- Bidirectional frequency synchronization
- High performance error amplifier
- Precision enable and POK for sequencing
- Programmable soft-start and soft-shutdown
- Full suite of protections: OCP, SCP, OTP, Input OVLO, UVLO, Output OVP with programmable threshold
- Monotonic startup into pre-biased loads
- RoHS compliant, MSL level 3, 260°C reflow

### APPLICATIONS

- Noise sensitive FPGA rails such as transceiver and high-speed IO
- Sensitive RF applications such as RRU
- Wireless and Wireline communications systems
- Data Center and Cloud server and storage equipment

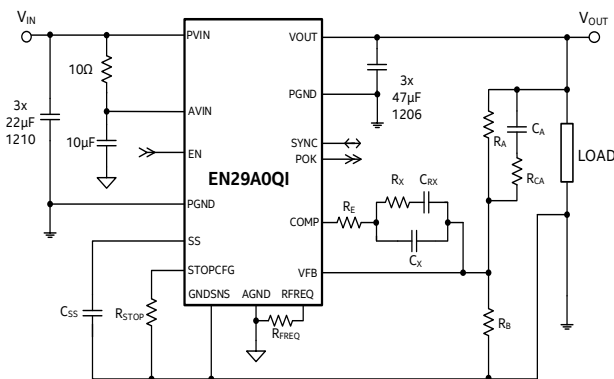

Figure 1: Simplified Applications Circuit

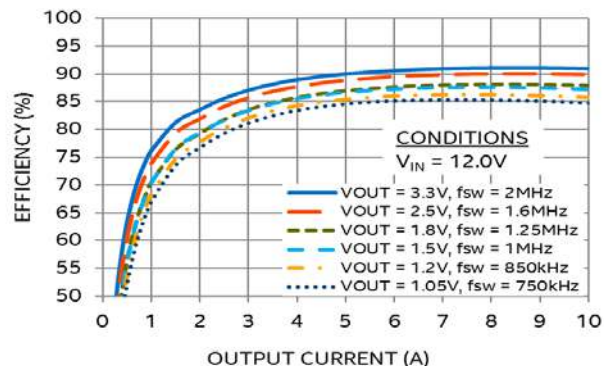

Figure 2: Efficiency at VIN = 12 V

## ORDERING INFORMATION

Table 1

Part Number	Package Markings	T <sub>J</sub> Rating (°C)	Package Description
EN29A0QI	EN29A0QI	-40 to +125	84-pin (12mm x 14mm x 4mm) QFN
EVB-EN29A0QI	EN29A0QI	QFN Evaluation Board	

Packing and Marking Information: <https://www.altera.com/support/quality-and-reliability/packing.html>

## PIN ASSIGNMENTS

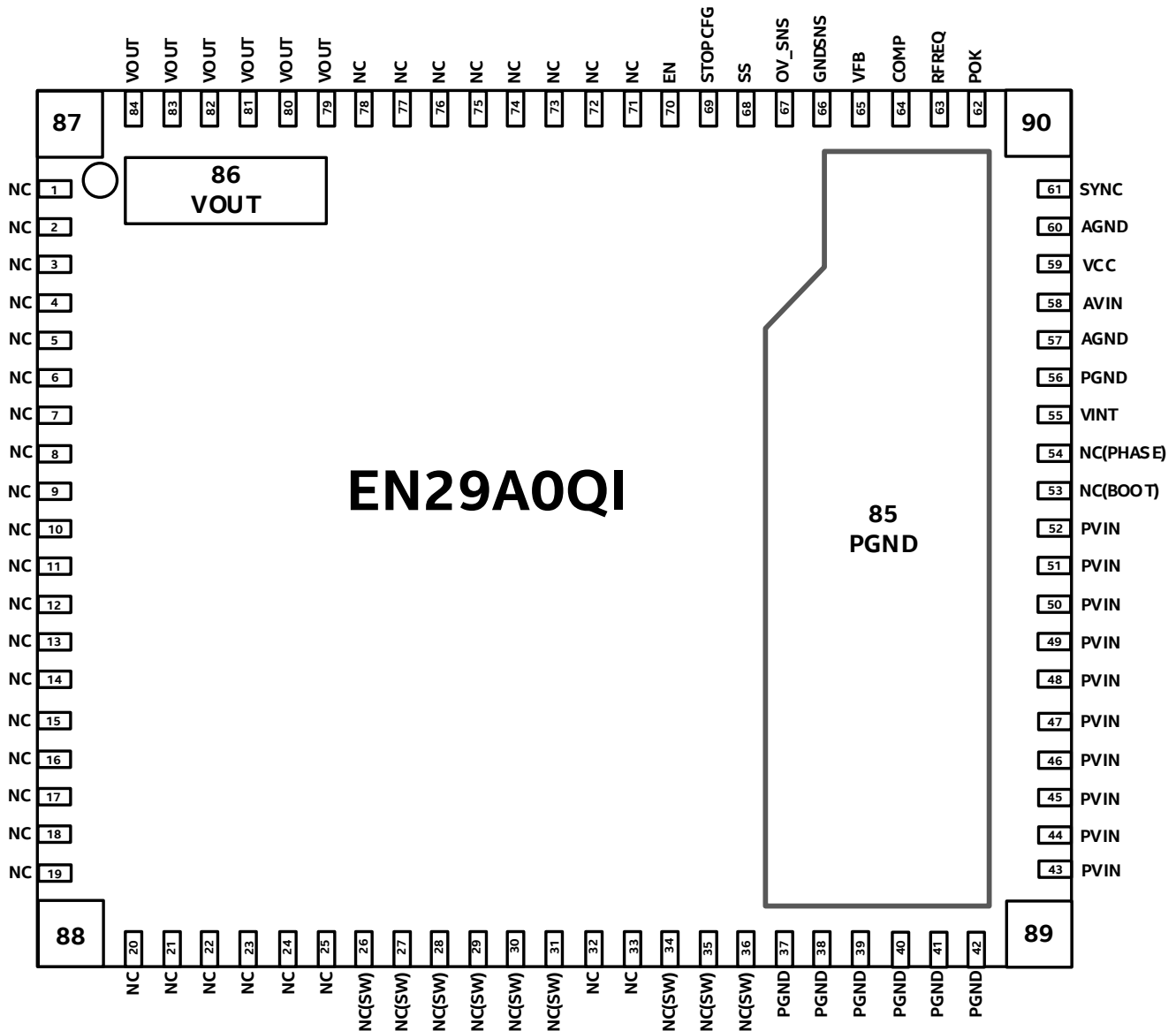

Figure 3: Pin Out Diagram (Top View)

NOTE A: White 'dot' on top left is pin 1 indicator on top of the device package.

## PIN DESCRIPTION

Table 2

PIN	NAME	I/O	FUNCTION
1-19	NC	-	These pins must be soldered to PCB. These pins are not tied to any internal signal, voltage, or ground, and may be connected to the VOUT plane. Refer to Layout Recommendation section.
20-25, 32, 33, 71-78	NC	-	No Connect. These pins must be soldered to PCB but not electrically connected to each other or to any external signal, voltage, or ground. These pins may be connected internally. Failure to follow this guideline may result in device damage.
26-31, 34-36	NC(SW)	-	No Connect. These pins are internally connected to the common switching node of the internal MOSFETs. They must be soldered to PCB but not be electrically connected to any external signal, ground, or voltage. Failure to follow this guideline may result in device damage.
37-42, 56	PGND	Ground	Input/output power ground. Connect to the ground electrode of the input and output filter capacitors. See VOUT and PVIN pin descriptions for more details.
43-52	PVIN	Power	Input power supply. Connect to input power supply. Decouple with input capacitor to PGND pin.
53	NC(BOOT)	-	No Connect. This pin is internally connected to the bootstrap capacitor. It must be soldered to PCB but not be electrically connected to any external signal, ground, or voltage. Failure to follow this guideline may result in device damage. It is recommended, but not mandatory, to have a test point on this pin for debug purposes.
54	NC(PHASE)	-	No Connect. This pin is internally connected to the switching node and is the return pin of the bootstrap capacitor. It must be soldered to PCB but not be electrically connected to any external signal, ground, or voltage. Failure to follow this guideline may result in device damage. It is recommended, but not mandatory, to have a test point on this pin for debug purposes.
55	VINT	Analog	Internal regulated voltage rail used for internal circuitry. Decouple with 2.2µF ceramic capacitor to PGND. This rail may not be used to power external circuitry.
57, 60	AGND	Power	The quiet ground for the control circuits. Connect to the ground plane with a via right next to the pin.
58	AVIN	Power	Input power supply for the controller. Connect to input voltage at a quiet point through a RC filter.
59	VCC	Analog	Internal regulated voltage rail used for internal circuitry. Decouple with 100nF ceramic capacitor to AGND. This rail may not be used to power external circuitry.

PIN	NAME	I/O	FUNCTION
61	SYNC	Digital	Bidirectional frequency synchronization pin. Depending on whether the part is a SYNC Master or Slave, this pin can provide a synchronization clock to other devices or accept an external clock input. This pin may be left floating when not used. Refer to section on Frequency Synchronization and Master/Slave Operation for details on SYNC configuration.
62	POK	Digital	Power OK is an open drain transistor used for power system state indication. POK is logic high when VOUT is within +10% to -8% of VOUT nominal (refer to Electrical Characteristics Table for range of VOUT within which POK is high).
63	RFREQ	Analog	Frequency adjust pin. This pin must have a resistor to AGND which sets the free running frequency of the internal oscillator.
64	COMP	Analog	Error amplifier output. Allows for customization of control loop.
65	VFB	Analog	This is the external feedback input pin. A resistor divider connects from the output to GNDSNS. The mid-point of the resistor divider is connected to VFB. A feed-forward capacitor ( $C_A$ ) and resistor ( $R_{CA}$ ) are required parallel to the upper feedback resistor ( $R_A$ ). VOUT regulation is based on the VFB node voltage equal to 0.6V.
66	GNDSNS	Analog	Ground sense pin. Connect to load ground. The soft-start capacitor, soft-shutdown resistor and the feedback resistor are referenced to GNDSNS.
67	OV_SNS	Analog	Output over-voltage sense pin. Connect to VFB pin unless external OVP circuit is desired. Connect to AGND when not used. Refer to section on Programming Output Voltage trip-point for details on OV_SNS configuration.
68	SS	Analog	A soft-start capacitor is connected between this pin and GNDSNS. The value of the capacitor controls the soft-start interval. Refer to soft-start in the Functional Description for more details.
69	STOPCFG	Analog	Soft-shutdown configuration. A resistor connected between this pin and GNDSNS sets the output soft-shutdown time. If STOPCFG is open, the output will tri-state when disabled. Refer to Soft-shutdown in the Functional Description for more details.
70	EN	Analog	Input Enable. Applying logic high enables the output and initiates a soft-start. Applying logic low disables the output according to the STOPCFG configuration.
79-84	VOUT	Power	Regulated converter output. Connect to the load and place output filter capacitor(s) between these pins and PGND pins.
85	PGND	Ground	Not a perimeter pin. Device thermal pad to be connected to the system GND plane for heat-sinking purposes. Refer to Layout Recommendation section.

PIN	NAME	I/O	FUNCTION
86	VOUT	Power	Not a perimeter pin. Device thermal pad to be connected to the system VOUT plane for heat-sinking purposes. Refer to Layout Recommendation section.
87-90	NC	-	Corner pads (mechanical purpose). These pins must be soldered to PCB. These pins are not tied to any internal signal, voltage, or ground, and may be connected to the PVIN, VOUT or PGND planes. Refer to Layout Recommendation section.

## ABSOLUTE MAXIMUM RATINGS

**CAUTION:** Absolute Maximum ratings are stress ratings only. Functional operation beyond the recommended operating conditions is not implied. Stress beyond the absolute maximum ratings may impair device life. Exposure to absolute maximum rated conditions for extended periods may affect device reliability.

### Absolute Maximum Pin Ratings

Table 3

PARAMETER	SYMBOL	MIN	MAX	UNITS
PVIN, AVIN, VOUT		-0.3	18.7	V
VFB, SS, COMP, RFREQ, STOPCFG, OVSNS		-0.3	2.5	V
POK, SYNC			6.0	V
EN (internal clamp inactive)			3.6	V
Enable pin input current (EN pulled up to AVIN through resistor)	$I_{EN}$		200	$\mu A$
NC(SW) Voltage DC	$V_{SW}$	-0.3	PVIN+0.3	V
NC(SW) Voltage Peak < 10ns		-3	25	V

### Absolute Maximum Thermal Ratings

PARAMETER	CONDITION	MIN	MAX	UNITS
Maximum Operating Junction Temperature			+150	$^{\circ}C$
Storage Temperature Range		-65	+150	$^{\circ}C$
Reflow Peak Body Temperature	(10 Sec) MSL3 JEDEC J-STD-020A		+260	$^{\circ}C$

### Absolute Maximum ESD Ratings

PARAMETER	CONDITION	MIN	MAX	UNITS
HBM (Human Body Model)		$\pm 2000$		V
CDM (Charged Device Model)		$\pm 500$		V

## RECOMMENDED OPERATING CONDITIONS

Table 4

PARAMETER	SYMBOL	MIN	MAX	UNITS
Input Voltage Range	$V_{IN}$	9	16	V
Output Voltage Range	$V_{OUT}$	0.75	3.3	V
Output Current Range	$I_{OUT}$		10	A
Operating Junction Temperature	$T_J$	-40	+125	$^{\circ}C$

## THERMAL CHARACTERISTICS

Table 5

PARAMETER	SYMBOL	TYPICAL	UNITS
Thermal Shutdown	$T_{SD}$	150	°C
Thermal Shutdown Hysteresis	$T_{SDH}$	30	°C
Thermal Resistance: Junction to Ambient (0 LFM) <sup>(1)</sup>	$\theta_{JA}$	10	°C/W
Thermal Resistance: Junction to Case (0 LFM)	$\theta_{JC}$	0.5	°C/W

(1) Based on 2oz. external copper layers and proper thermal design in line with EIJ/JEDEC JESD51-7 standard for high thermal conductivity boards.

## ELECTRICAL CHARACTERISTICS

NOTE: The minimum and maximum values are over the operating junction temperature range (-40°C to 125°C) unless otherwise noted. Typical values are tested at  $V_{IN} = 12V$  and  $T_A = 25^\circ C$ .

Table 6

PARAMETER	SYMBOL	TEST CONDITIONS	MIN	TYP	MAX	UNITS
Operating Input Voltage	$V_{IN}$	PVIN tied to AVIN with a 10 ohm resistor	9		16	V
Input Under Voltage Lock-Out – AVIN Rising	$V_{UVLOR}$	Voltage above which UVLO is not asserted	7.75	8.19	8.75	V
Input Under Voltage Lock-Out – AVIN Falling	$V_{UVLOF}$	Voltage below which UVLO is asserted	7.25	7.83	8.25	V
Input Under Voltage Lock-Out Hysteresis				300		mV
Input Over Voltage Lock-Out – AVIN Rising	$V_{OVLOR}$	Voltage above which OVLO is asserted	16.5	17.5	18.5	V
Input Over Voltage Lock-Out – AVIN Falling	$V_{OVLOF}$	Voltage below which OVLO is not asserted	16	17.0	18	V
PVIN Slew rate <sup>(2)</sup>			1		120	V/ms
Shut-Down Supply Current	$I_S$	EN = 0; (AVIN + PVIN current)	9	13	25	mA
AVIN Quiescent Current	$I_{AVINQ}$	EN= 1; AVIN current only	1	10	12	mA
No Load Quiescent Current	$I_{VINQ}$	PVIN + AVIN current $V_{OUT} = 1.2V$	35	49	65	mA
Feedback Pin Voltage <sup>(3)</sup> (Line, Load, Temperature)	$V_{FB}$	$9V \leq V_{IN} \leq 16V$ $0A \leq I_{LOAD} \leq 10A$ $-40^\circ C \leq T_A \leq 85^\circ C$	0.594	0.6	0.606	V
Feedback pin Input Leakage Current	$I_{FB}$	VFB pin input leakage current	-10		10	nA
Switching frequency	$f_{SW}$	Free-running (set with $R_{FREQ}$ )	450		2000	kHz
Switching frequency accuracy		Not including $R_{FREQ}$ tolerance ( $R_{FREQ} = 30.1k\Omega$ , $f_{SW} = 1 MHz$ )	-5		+5	%
Minimum On-time	$T_{ON\_MIN}$	Measured at SW node	20	39	56	ns
External Sync Amplitude – High			1.4		3.6	V



PARAMETER	SYMBOL	TEST CONDITIONS	MIN	TYP	MAX	UNITS
External Sync Amplitude – Low					0.6	V
Sync pin Rise time <sup>(2)</sup>		When SYNC is an output and driving $C_L < 30\text{pF}$			80	ns
External Sync Minimum Pulse Width		3.3V/1.8V logic, edge triggered	50			ns
External Sync Duty Max		3.3V/1.8V logic			90	%
External Sync– Programmed Freq difference	$\Delta f_{\text{SYNC}}$	Maximum frequency difference to ensure synchronization			15	%
EN pin threshold (precision Enable)	$V_{\text{EN}}$		1.085	1.126	1.165	V
EN Hysteresis	$V_{\text{EN\_HYST}}$		75	122	165	mV
EN Pin Current	$I_{\text{EN}}$	$V_{\text{EN}} = 3.6\text{V}$			1	$\mu\text{A}$
EN high Response Delay		Time from when EN is high till soft-start begins to ramp			90	$\mu\text{s}$
EN low Response Delay		Time from EN low till output mode response			1.8	$\mu\text{s}$
ENABLE Lockout	$t_{\text{ENLO}}$	Once EN has been pulled low, internal lockout time before device will respond to an EN high event	10	12.2	15.5	ms
ENABLE Spurious Pulse Rejection		Leading edge blanking	200	330	600	ns
SS Pin voltage range <sup>(2)</sup>		Soft-start	0		0.6	V
SS Ramp Time <sup>(2)</sup>	$t_{\text{RISE}}$	$3.3\text{nF} \leq C_{\text{SS}} \leq 680\text{nF}$	0.1		20	ms
SS Pin charging current	$I_{\text{SS}}$		18	20	22	$\mu\text{A}$
Soft-start Discharge Resistance		Internal resistance	400	590	750	ohms
Soft-shutdown Resistance <sup>(2)(4)</sup>		STOPCFG pin resistor range	1		100	k $\Omega$
Soft-shutdown internal switch Resistance <sup>(2)</sup>		Switch resistance from SS to STOPCFG pins		100		$\Omega$

PARAMETER	SYMBOL	TEST CONDITIONS	MIN	TYP	MAX	UNITS
POK Threshold VOUT Rising		Range of Output Voltage as a Fraction of Programmed Value above which POK is Asserted.	92	93.8	95.5	%
POK Hysteresis		As a percentage of reference voltage	1	2.1	3.3	%
POK Logic Low		With 5mA current sink into POK pin	0.01	0.19	0.3	V
POK Low to High Delay Time		No Fault present			10	us
POK High to Low Delay Time		Fault or VOUT low			600	ns
OCP trip magnitude <sup>(5)</sup>	I <sub>OCP</sub>	V <sub>OUT</sub> = 1.5V, f <sub>sw</sub> = 1MHz	11	12.4	15	A
OCP_Timer		Time device may remain in OCP (current-limiting) mode before a fault	15	20	25	ms
OCP Timer Reset		Length of time of non-OCP cycles before OCP Timer is reset	5	10	20	ms
OVP Threshold		When using the same divider ratio as the VFB feedback divider circuit; measured as a percentage of nominal output voltage (V <sub>GNDSENS</sub> = V <sub>AGND</sub> )	107	110	113	%
OVP Fault Delay		Delay time from OVP fault to fault response			550	ns
Inductor Value			280	350	420	nH
DCR of the Inductor				2		mΩ

(2) Parameter not production tested but is guaranteed by design.

(3) The VFB pin controls the output voltage. Touching or injecting an external signal on the pin during operation may cause the output to change.

(4) Refer to section on soft-shutdown operation for R<sub>STOP</sub> recommendations

(5) OCP trip magnitude will vary with Switching frequency. Refer to section on programming Switching Frequency

## TYPICAL PERFORMANCE CURVES

NOTE: Typical performance curves are  $T_A = 25^\circ\text{C}$  unless otherwise noted.

### Efficiency vs. Output Current

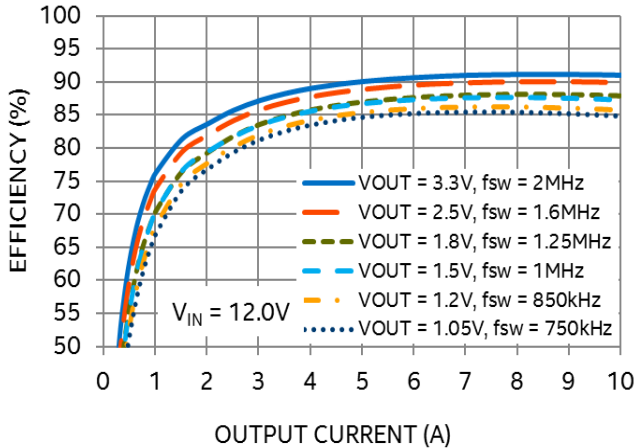

### Efficiency vs. Output Current

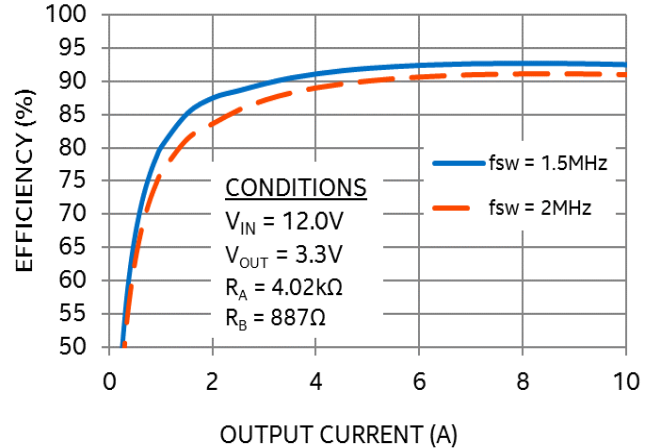

### Efficiency vs. Output Current

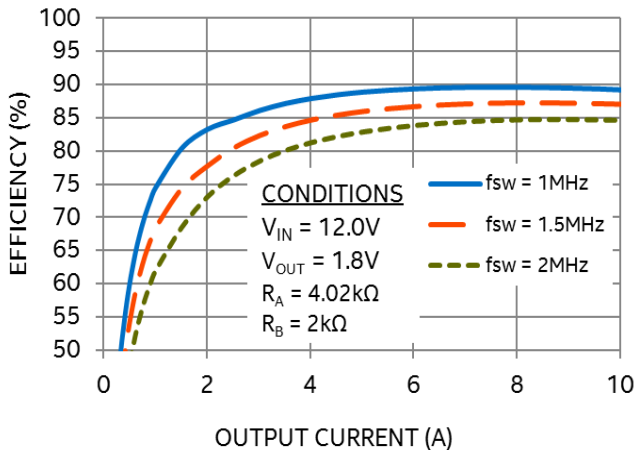

### Efficiency vs. Output Current

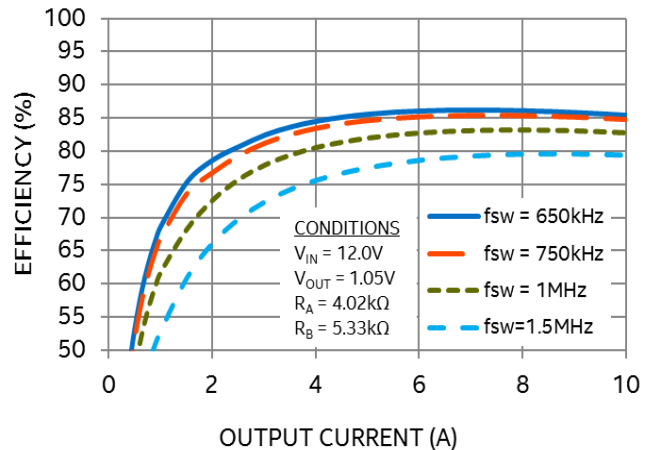

### Output voltage vs Output current

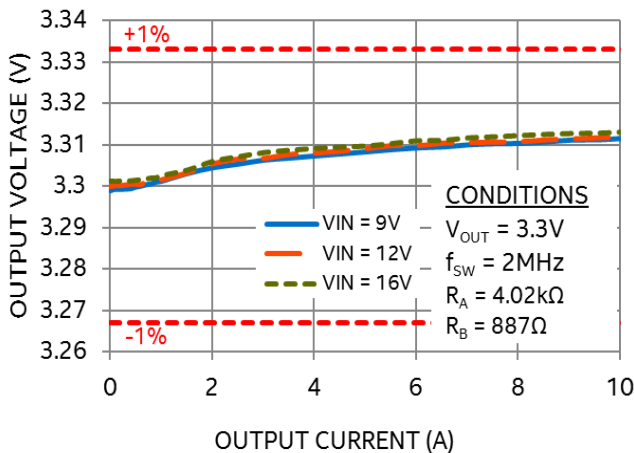

### Output voltage vs Output current

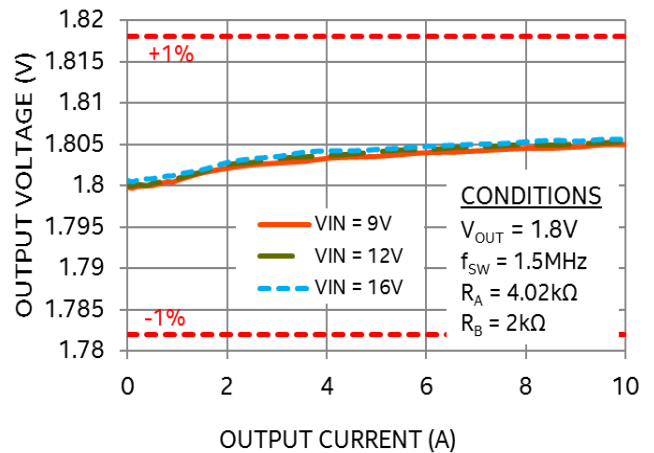

## TYPICAL PERFORMANCE CURVES (CONTINUED)

**Output voltage vs Output current**

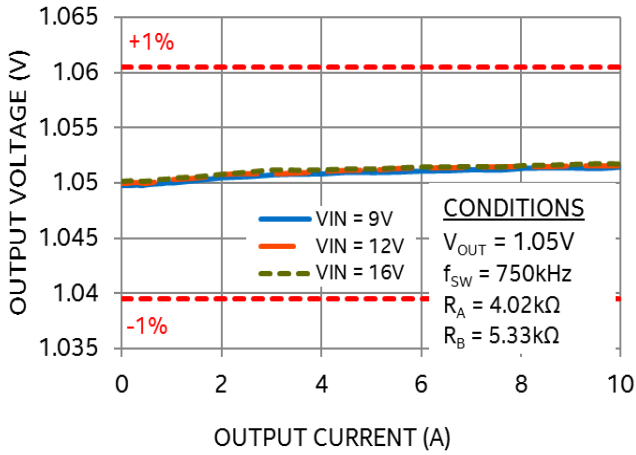

**Reference voltage vs Temperature**

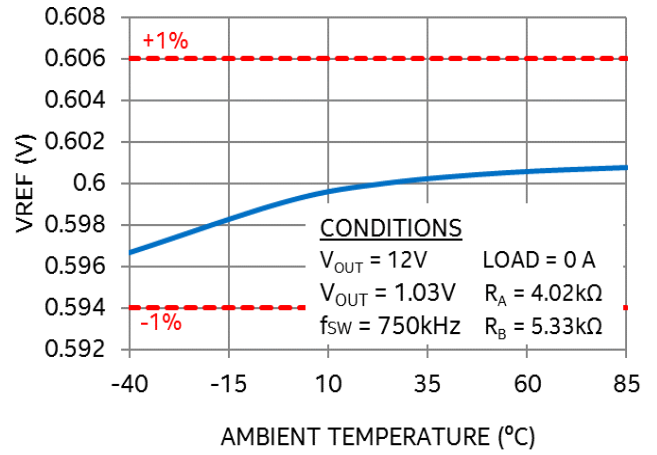

**Switching Frequency vs  $R_{FREQ}$**

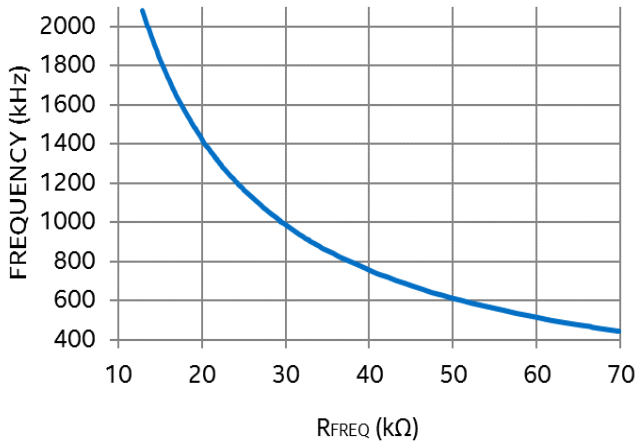

**Thermal Derating**

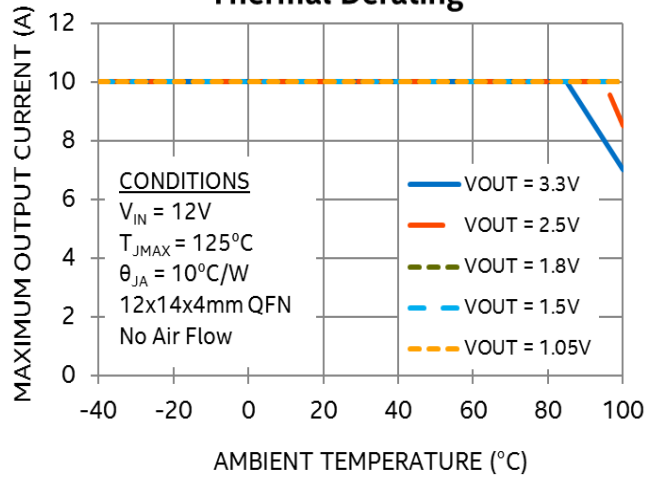

**EMI Performance**

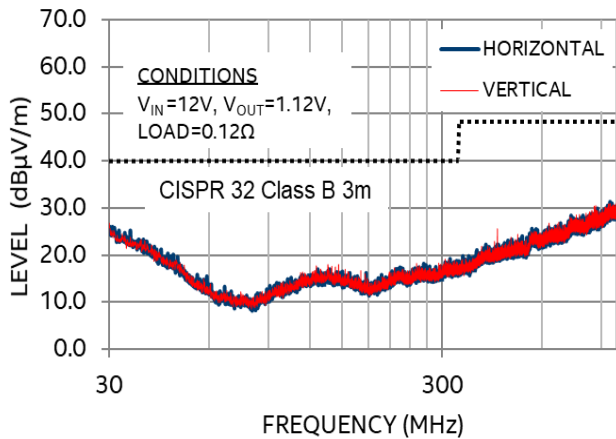

**EMI Performance**

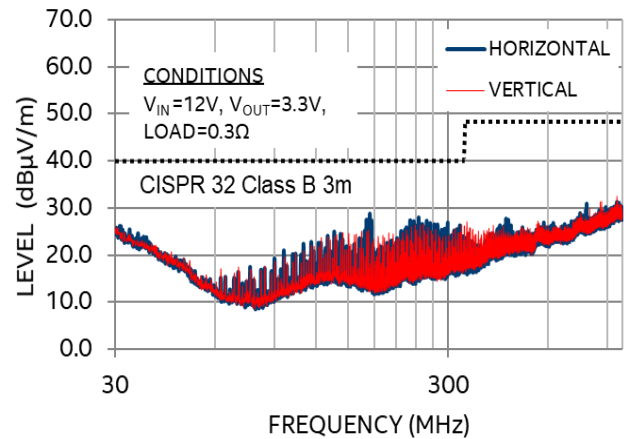

## TYPICAL PERFORMANCE CHARACTERISTICS

NOTE: Typical performance characteristics are  $T_A = 25^\circ\text{C}$  unless otherwise noted.

**Output Ripple at 500MHz Bandwidth**

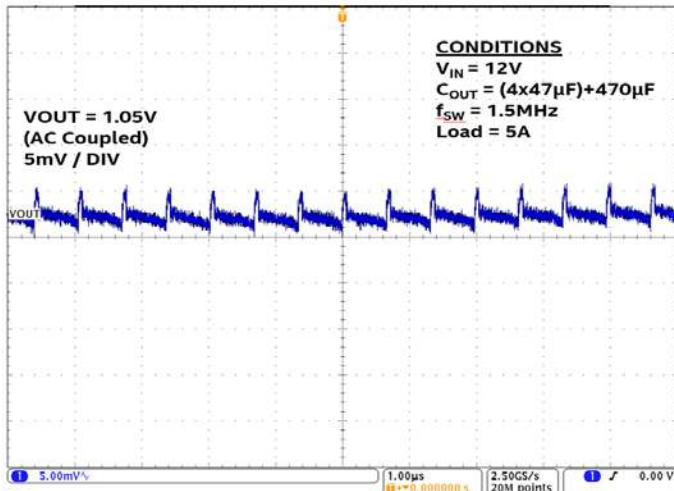

**Output Ripple at 20MHz Bandwidth**

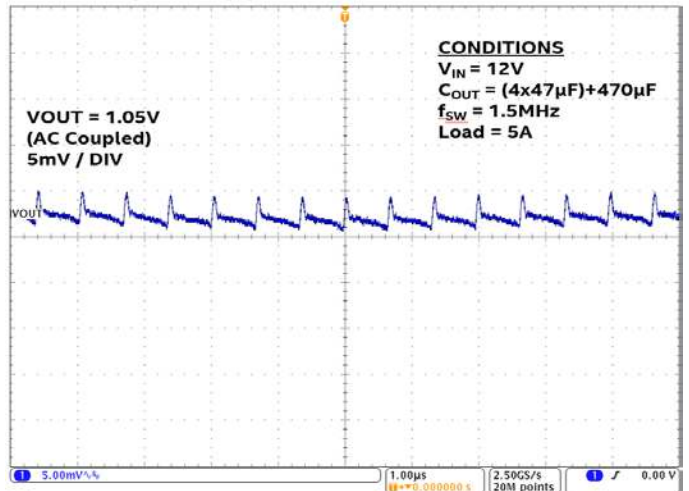

**Output Ripple at 500MHz Bandwidth**

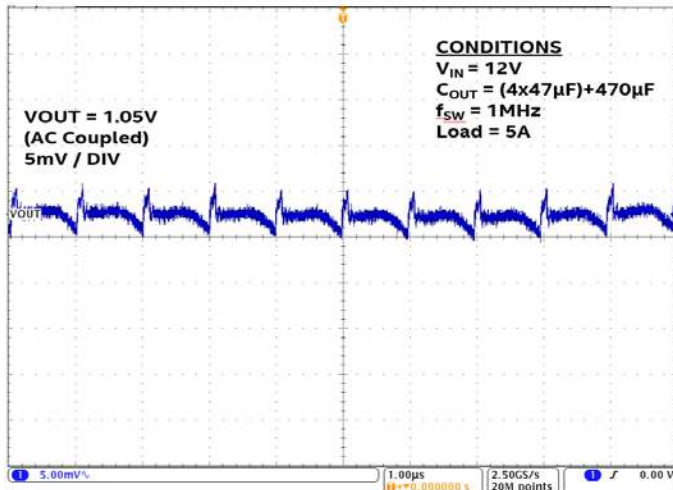

**Output Ripple at 20MHz Bandwidth**

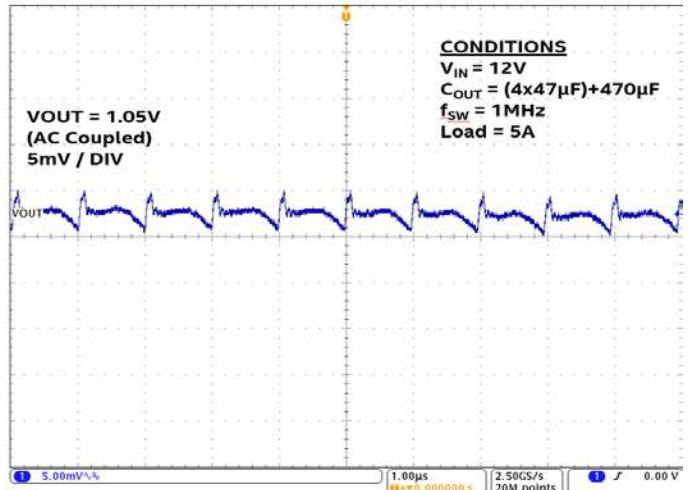

**Output Ripple at 500MHz Bandwidth**

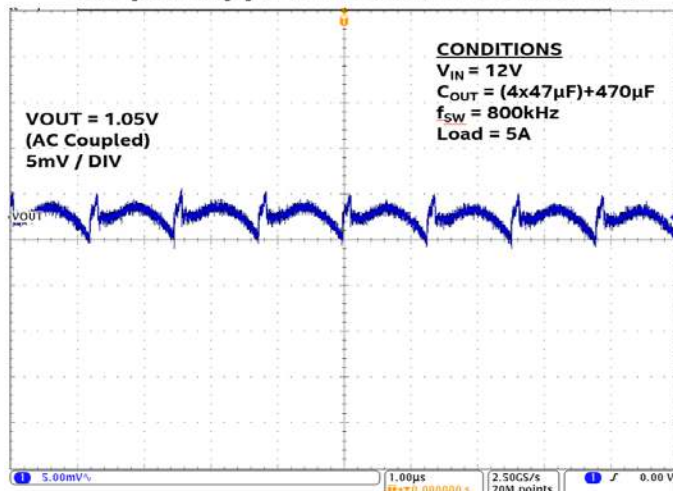

**Output Ripple at 20MHz Bandwidth**

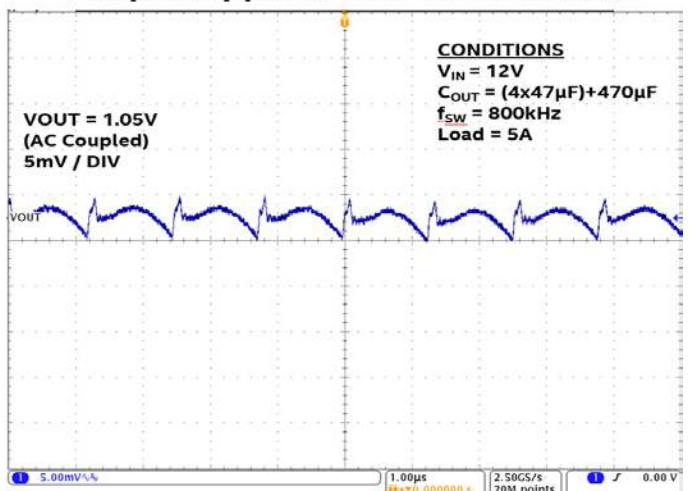

## TYPICAL PERFORMANCE CHARACTERISTICS (CONTINUED)

### Startup and Shutdown at No Load

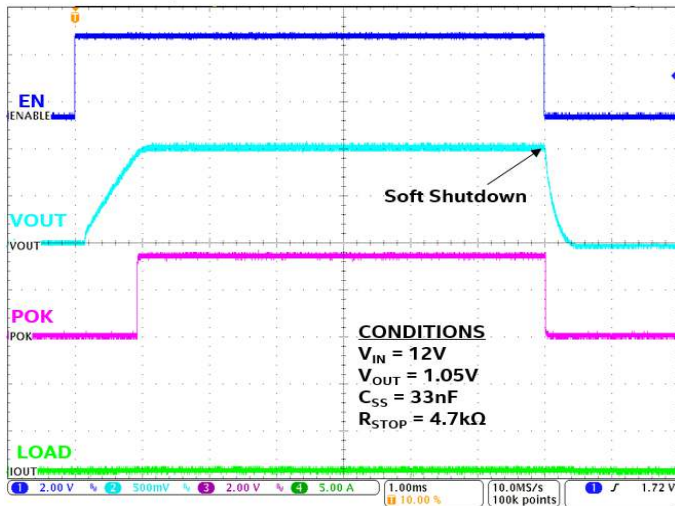

### Startup and Shutdown at No Load

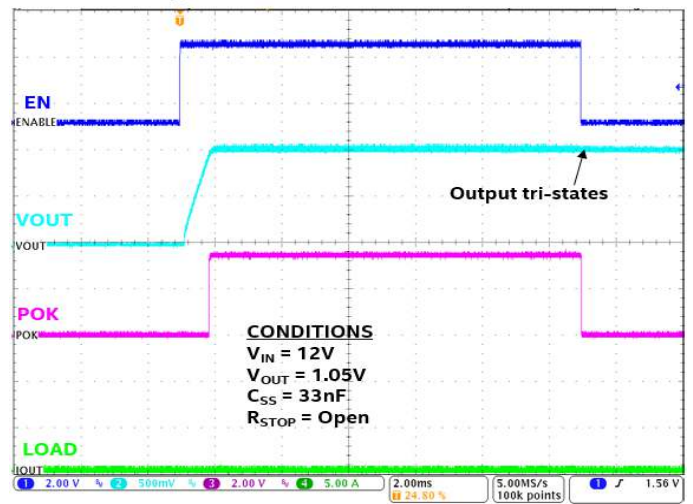

### Startup and Shutdown at 5A Load

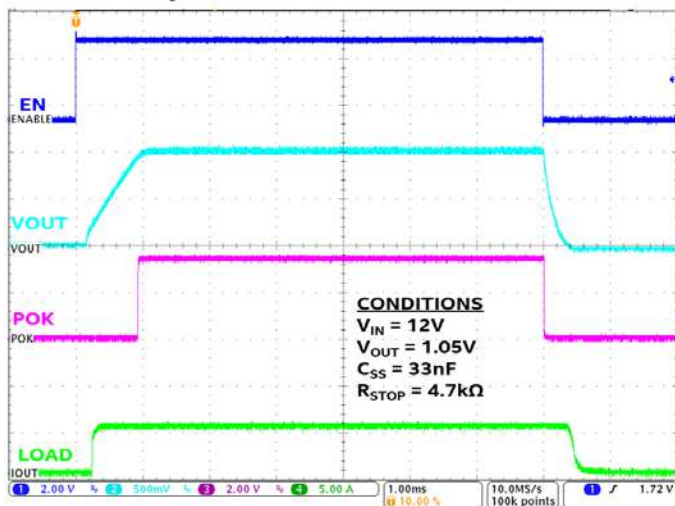

### Pre-Bias Startup

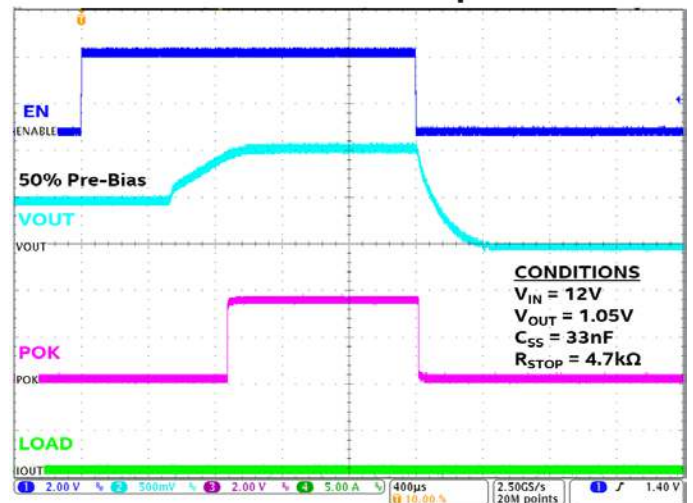

### Pre-Bias Startup

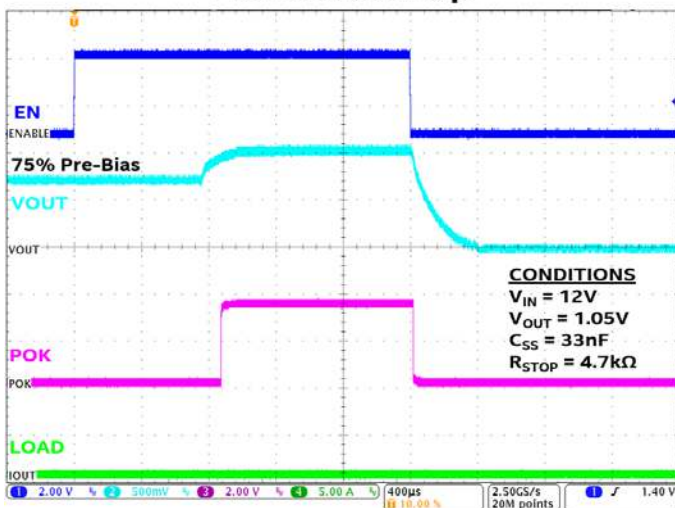

### Pre-Bias Startup

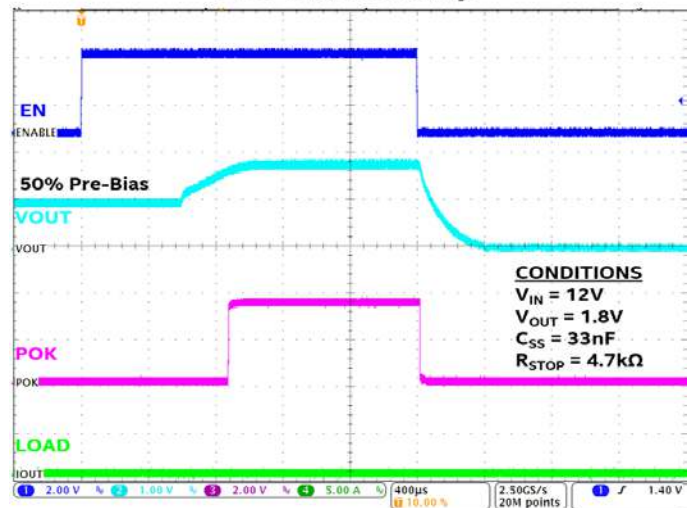

## TYPICAL PERFORMANCE CHARACTERISTICS (CONTINUED)

### Pre-Bias Startup

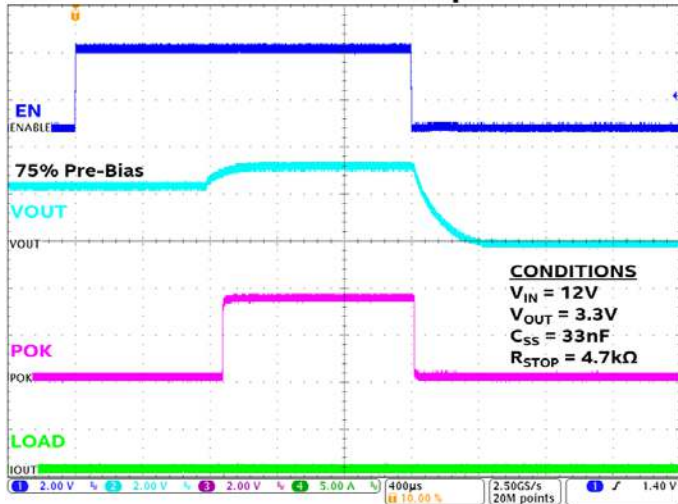

### VIN Startup at No Load

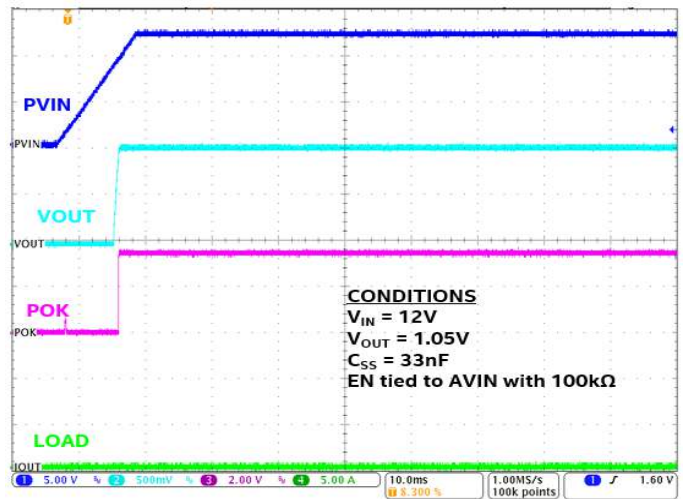

### VIN Shutdown at No Load

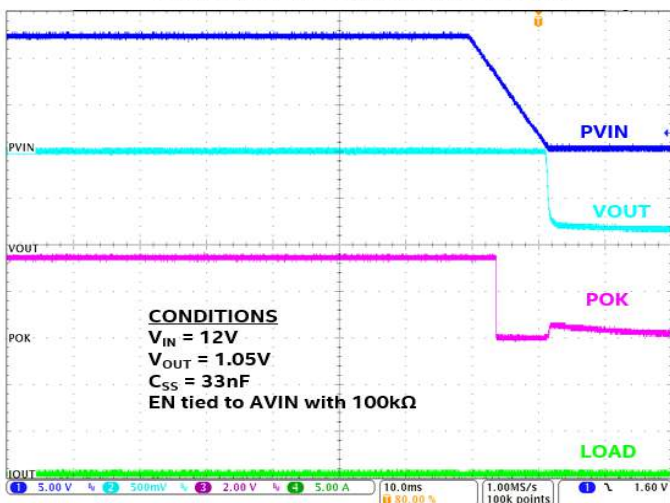

### VIN Startup at 5A Load

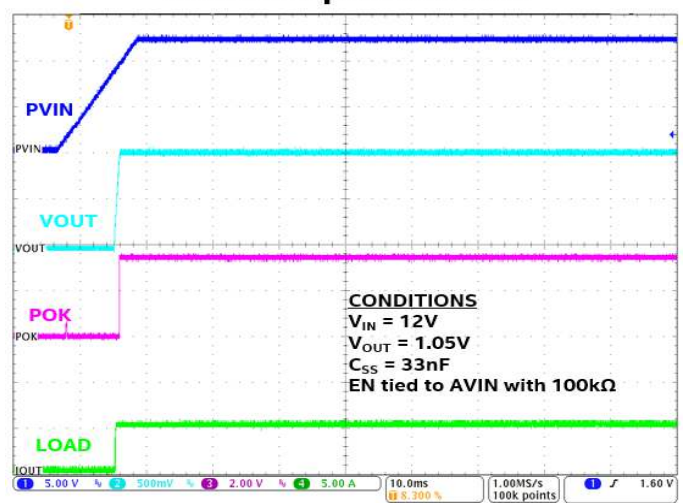

### VIN Shutdown at 5A Load

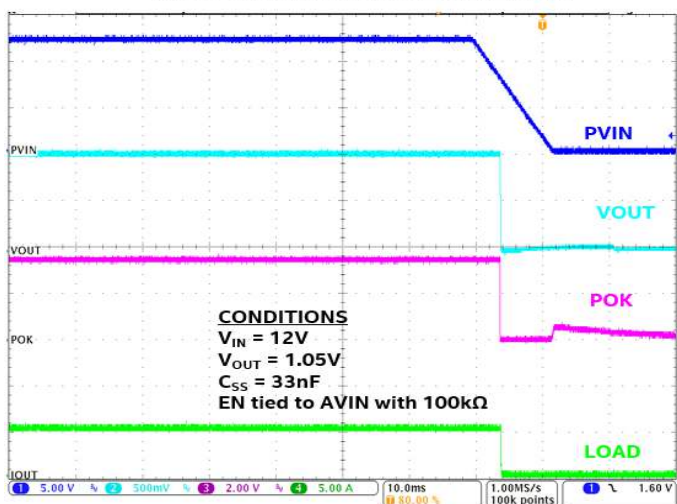

### OCP during steady-state operation

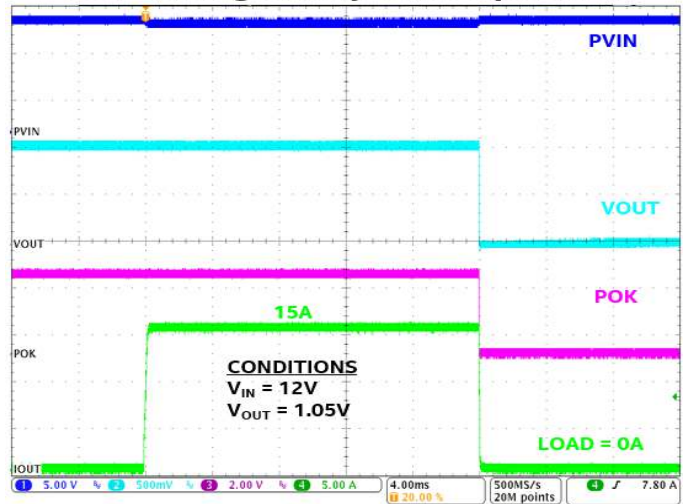

## TYPICAL PERFORMANCE CHARACTERISTICS (CONTINUED)

### Startup into Current limit

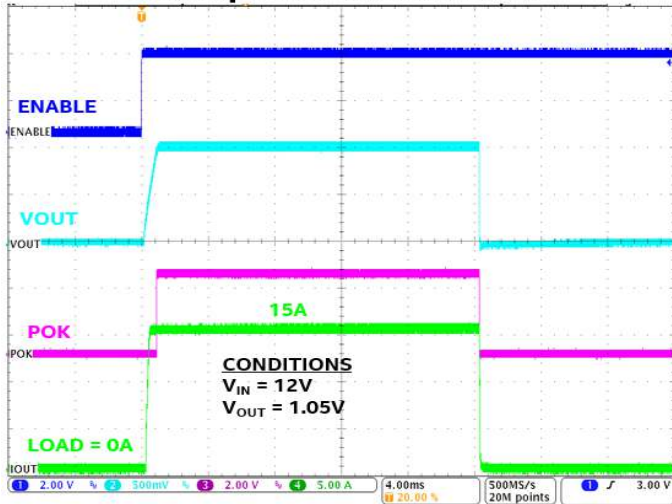

### Surge current capability

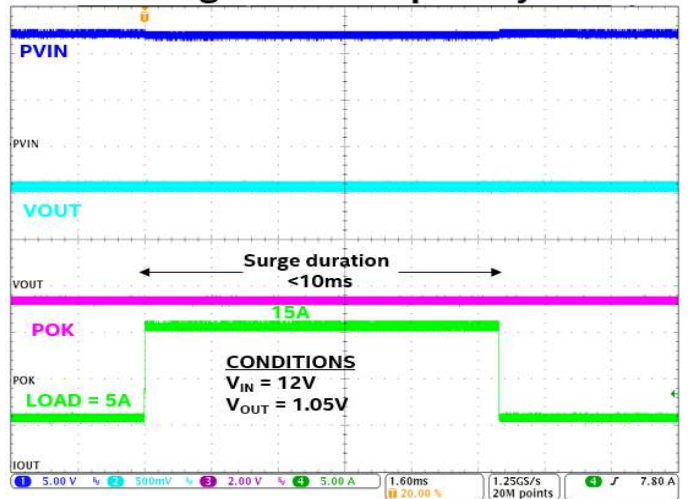

### Surge during startup

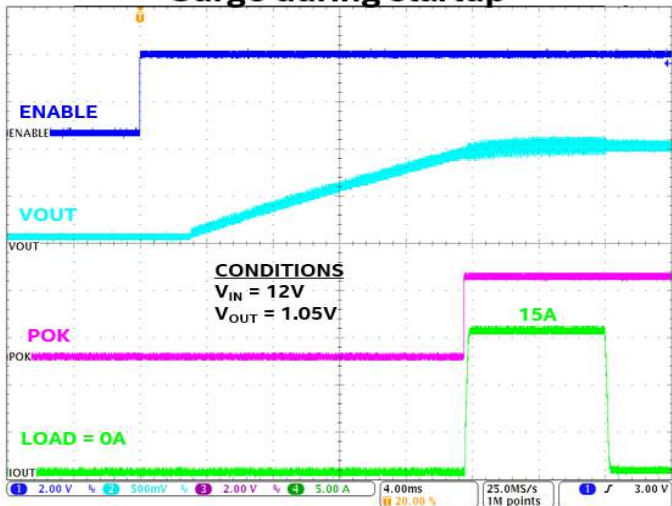

### Short-circuit protection

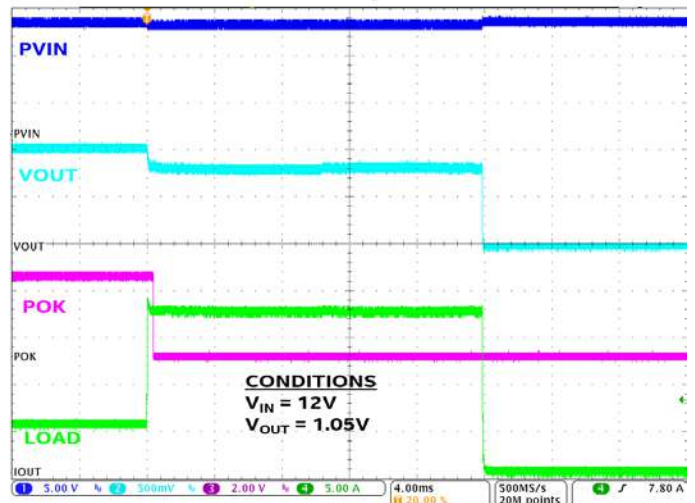

### Startup into a short-circuit

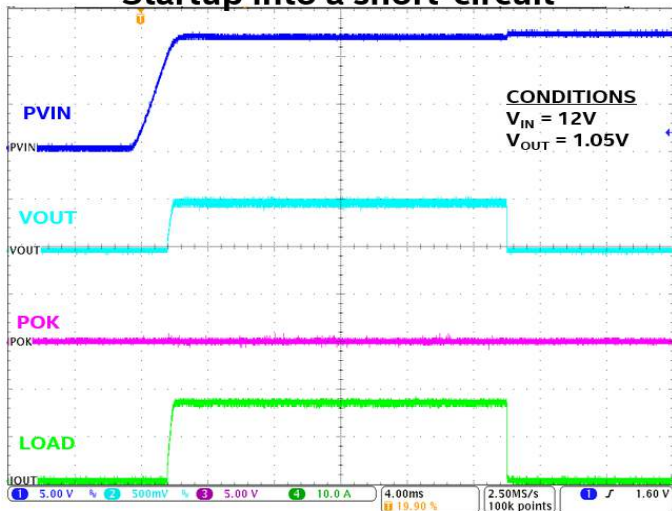



## TYPICAL PERFORMANCE CHARACTERISTICS (CONTINUED)

### Load Transient 2.5 to 7.5A

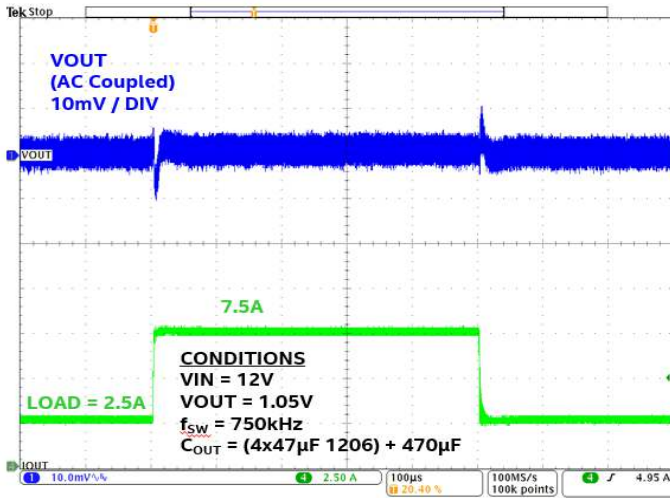

### Load Transient 5 to 10A

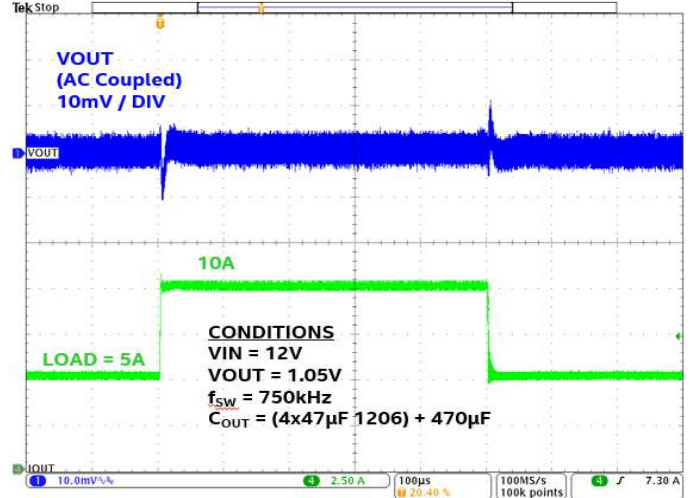

### Load Transient 0 to 10A

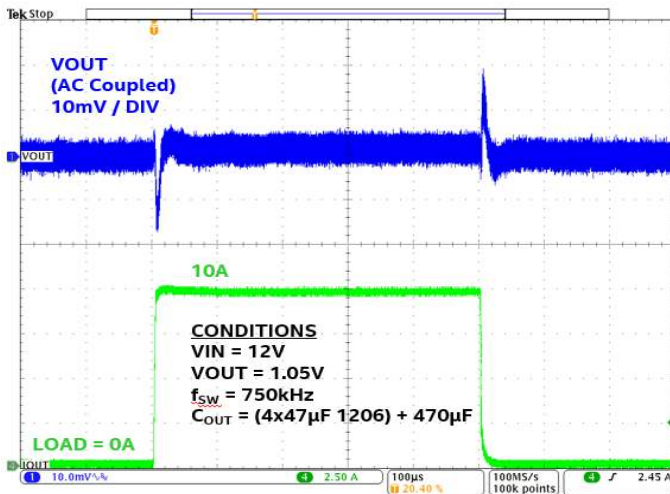

### Load Transient 2.5 to 7.5A

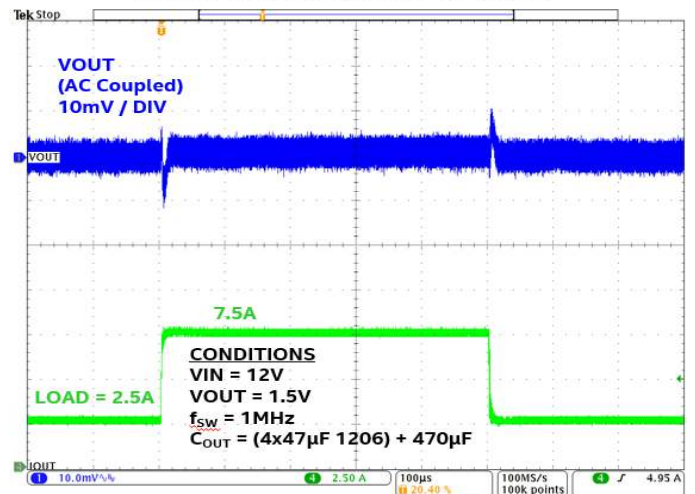

### Load Transient 5 to 10A

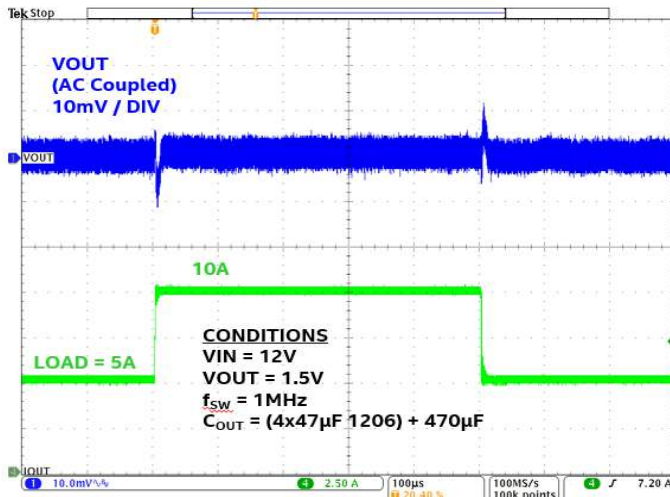

### Load Transient 0 to 10A

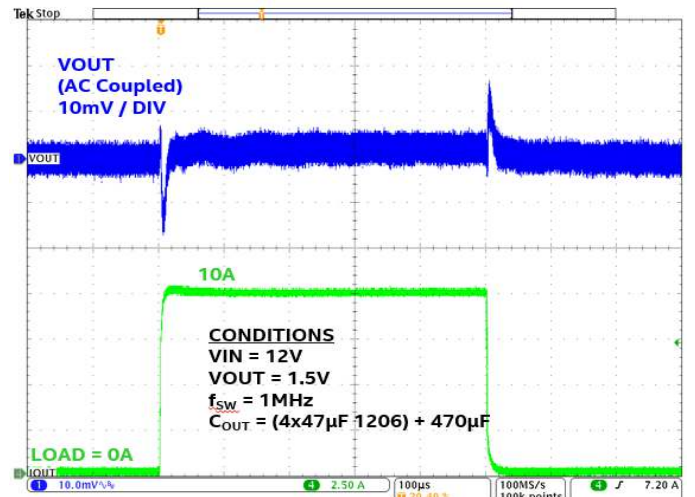

## FUNCTIONAL BLOCK DIAGRAM

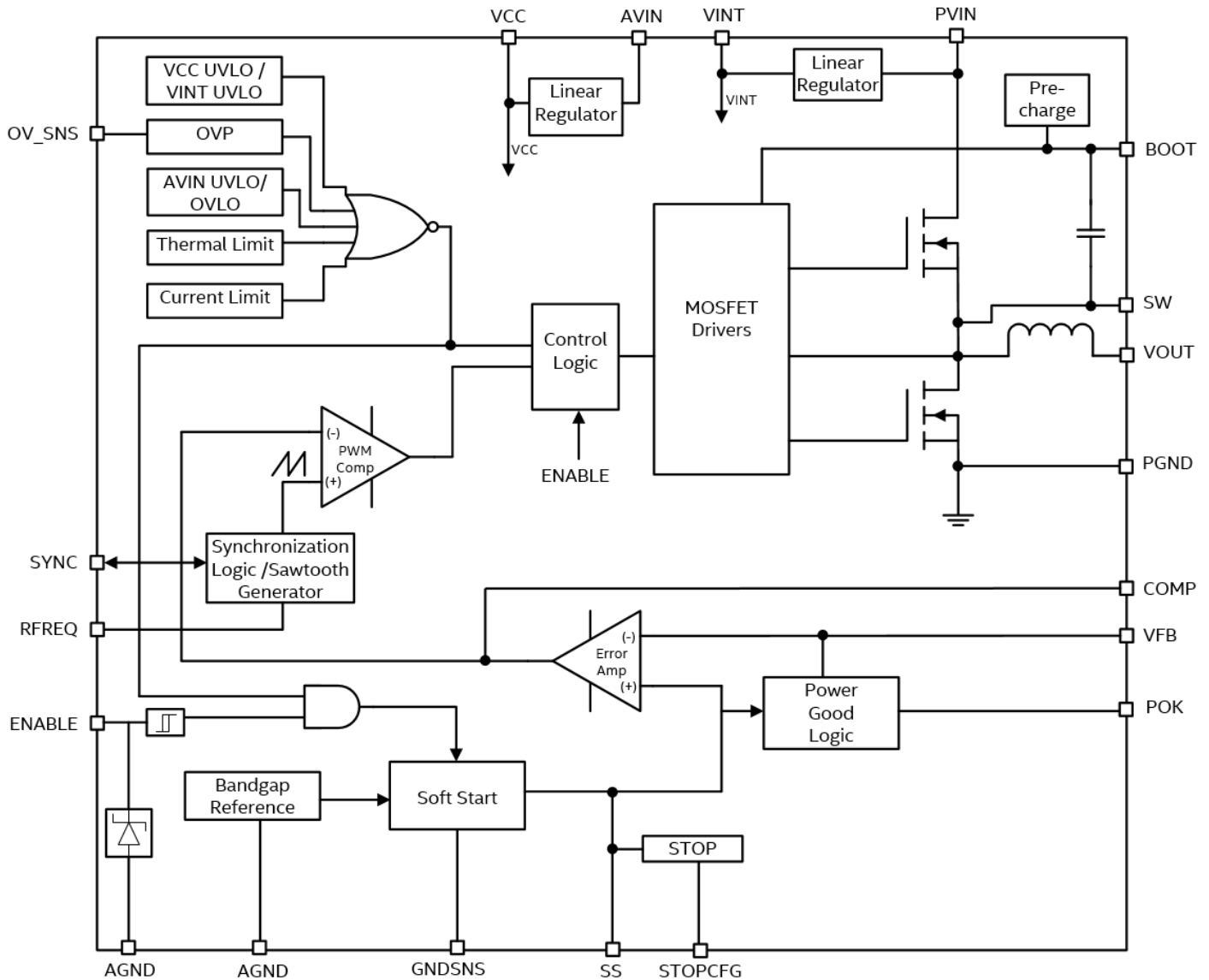

Figure 4: Functional Block Diagram

## FUNCTIONAL DESCRIPTION

### Synchronous Buck Module

The EN29A0QI is a highly integrated synchronous, buck converter with integrated controller, power MOSFET switches and integrated inductor. The nominal input voltage (PVIN) range is 9V to 16V and can support up to 10A of continuous output current. The output voltage is programmed using an external resistor divider network. The feedback control loop is customizable through external components. Type III or Type IV voltage mode control may be implemented to maximize control loop bandwidth and to maintain excellent phase margin to improve transient performance. The operating switching frequency is between 0.45MHz and 2MHz and enables the use of small-size input and output capacitors.

## Operational Features:

- Precision enable circuit with tight threshold range
- Soft-start circuit allowing controlled startup when the converter is initially powered up
- Power OK circuit indicating the output voltage is greater than 92% of programmed value
- Resistor programmable switching frequency
- Bidirectional frequency synchronization pin

## Protection Features:

- Over-current protection from excessive load current
- Thermal shutdown with hysteresis to prevent over temperature stress
- Output voltage pre-bias startup protection for smooth monotonic startup
- Output over-voltage protection
- Input under-voltage protection
- Input over-voltage protection

## Precision Enable Operation

The enable (EN) pin provides a mean to start up or to shut down the device. When the EN pin is asserted high, the device will undergo a normal soft-start where the output will rise monotonically into regulation. Asserting a logic low on this pin will deactivate the device by turning off the internal power switches and the POK flag will also be pulled low. The output will tri-state or go through a soft-shutdown when EN goes low depending on the resistor connected to STOPCFG pin (refer to the section on soft-shutdown operation for more details). The EN threshold is a precision analog voltage rather than a digital logic threshold. The EN pin may be connected to AVIN through a resistor (typically 100kΩ) or be controlled by a 3.3V/1.8V logic signal. The maximum input current on the EN pin when tied to AVIN through a resistor should not exceed 200μA. A precision voltage reference and a comparator circuit are kept powered up even when EN is de-asserted. The narrow voltage gap between EN Logic Low and EN Logic High allows the device to turn on at a precise enable voltage level. With the enable threshold pinpointed, a proper choice of soft-start capacitor helps to accurately sequence multiple power supplies in a system as desired. There is an Enable lockout time of 12.5ms that prevents the device from re-enabling immediately after it is disabled.

## Soft-Start Operation

The SS pin in conjunction with a small external capacitor between this pin and GNDSNS provides a soft-start function to limit in-rush current during device power-up. When the part is initially powered up, the output voltage is gradually ramped to its final value. The gradual output ramp is achieved by increasing the reference voltage to the error amplifier. A constant current flowing into the soft-start capacitor provides the reference voltage ramp. When the voltage on the soft-start capacitor reaches 0.60V, the output has reached its programmed voltage. The output rise time can be controlled by the choice of soft-start capacitor value.

The rise time is defined as the time from when the enable signal crosses the threshold and the input voltage crosses the upper UVLO threshold to the time when the output voltage reaches 95% of the programmed value. The rise time ( $t_{RISE}$ ) is given by the following equation:

$$t_{RISE} [ms] = C_{SS} [nF] \times 0.03$$

With a 33nF soft-start capacitance on the SS pin, the soft-start rise time will be set to 0.99ms. The recommended range for the value of the SS capacitor is between 3.3nF and 680nF. Note that excessive bulk capacitance on the output can cause an over current event on startup if the soft-start time is too low. The minimum soft-start time for a given output voltage and output capacitance is given by:

$$t_{\text{RISE, min}} = 0.1 \times V_{\text{OUT}} \times C_{\text{OUT}}$$

## Soft-Shutdown Operation

The EN29A0 has a programmable soft-shutdown, controlled by a resistor,  $R_{\text{STOP}}$ , on the STOPCFG pin. When the ENABLE pin goes low, internal circuitry detects the presence of a resistor on the STOPCFG pin. This resistor forms a RC circuit with the soft-start capacitor to determine the output decay time. If STOPCFG pin is left open, the output tri-states when the part is disabled. The soft-shutdown time is calculated as

$$t_{\text{STOP}} [\mu\text{s}] = 3 \times C_{\text{SS}} [\text{nF}] \times R_{\text{STOP}} [\text{k}\Omega]$$

The recommended range for the value for  $R_{\text{STOP}}$  is between 1k $\Omega$  and 100k $\Omega$ . To prevent the output voltage from undershooting on shutdown, the minimum recommended  $R_{\text{STOP}}$  for a given combination of  $V_{\text{OUT}}$ ,  $C_{\text{OUT}}$  and  $C_{\text{SS}}$  is given by

$$R_{\text{STOP}} = \frac{\pi C_{\text{OUT}} V_{\text{OUT}}}{10 C_{\text{SS}}}$$

Note that  $R_{\text{STOP}}$  must be configured before the device is powered on. The maximum soft-shutdown time is limited by the EN lockout time ( $t_{\text{ENLO}}$ ) found in the Electrical Characteristics Table. If  $t_{\text{STOP}}$  is greater than  $t_{\text{ENLO}}$ , then the output will soft-shutdown till it reaches  $t_{\text{ENLO}}$  after which it will tri-state. The soft-shutdown mode is available only when EN is pulled low during normal operation – in the event of a fault, the output will tri-state regardless of the presence of a resistor on the STOPCFG pin. Note that excessive bulk capacitance on the output can cause an over-current event on shutdown if the soft-shutdown time is too low. For a given output voltage and output capacitance the minimum soft-shutdown time to prevent an over-current event on shutdown is given by:

$$t_{\text{STOP, min}} = 0.1 \times V_{\text{OUT}} \times C_{\text{OUT}}$$

## POK Operation

The POK signal is an open drain signal (requires a pull up resistor to VCC or similar voltage) from the converter indicating the output voltage is within the specified range. Typically, a 100k $\Omega$  or lower resistance is used as the pull-up resistor. The POK signal will be logic high when the rising output voltage crosses 93.8% (nominal) of the programmed voltage level. If the output voltage falls below the falling threshold, the POK signal will be de-asserted. POK is also logic low if any of the conditions are met: 1) the input voltage is below  $V_{\text{UVLOR}}$ , 2) EN is pulled low, 3) any other faults are present in the system. The POK signal can be used to sequence downstream converters by tying to their enable pins.

## Resistor Programmable Frequency

The operation of the EN29A0QI can be optimized by proper choice of the  $R_{\text{FREQ}}$  resistor. The frequency can be tuned to optimize dynamic performance and efficiency. The corresponding  $R_{\text{FREQ}}$  values may be obtained from the  $f_{\text{SW}}$  vs  $R_{\text{FREQ}}$  characteristic curve. Table 7 provides a list of recommended frequencies for some common output voltage settings at  $V_{\text{IN}} = 12\text{V}$ .

A reduced frequency may be desired in some applications to achieve better efficiency. However, note that at lower frequencies the average OCP current magnitude is also reduced proportionally due to an increase in the inductor peak-peak ripple current. The relationship between OCP magnitude,  $I_{\text{OCP}}$ , and the switching frequency,  $f_{\text{SW}}$ , is given by:

$$\Delta I_{OCP} [A] \propto 1/(2 \times \Delta f_{sw} [MHz])$$

where  $\Delta I_{OCP}$  is the change in OCP level from the nominal OCP level for a change in frequency of  $\Delta f_{sw}$ .

**Table 7**

VOUT (V)	Minimum frequency		Recommended frequency		Maximum frequency	
	Frequency (MHz)	R <sub>FREQ</sub> (kΩ)	Frequency (MHz)	R <sub>FREQ</sub> (kΩ)	Frequency (MHz)	R <sub>FREQ</sub> (kΩ)
0.75	0.45	68.1	0.5	60.4	0.75	40.2
1	0.5	60.4	0.75	40.2	1	30.1
1.2	0.6	51.1	0.85	35.7	1.25	23.2
1.5	0.7	43.2	1	30.1	1.55	18.2
1.8	0.8	38.3	1.25	23.3	1.85	14.7
2.5	1	30.1	1.6	17.4	2	13.7
3.3	1.25	23.3	2	13.7	2	13.7

### Frequency Synchronization and Master/ Slave operation

The EN29A0QI's switching frequency may be synchronized to an external clock signal through the bidirectional SYNC pin, provided the external synchronization frequency is higher than the frequency set by the frequency adjust resistor, R<sub>FREQ</sub>. When a clock signal is present at SYNC, an activity detector detects the leading edge of the clock signal and the internal oscillator phase locks to the external clock. Refer to the Electrical Characteristics Table for specifications to ensure synchronization.

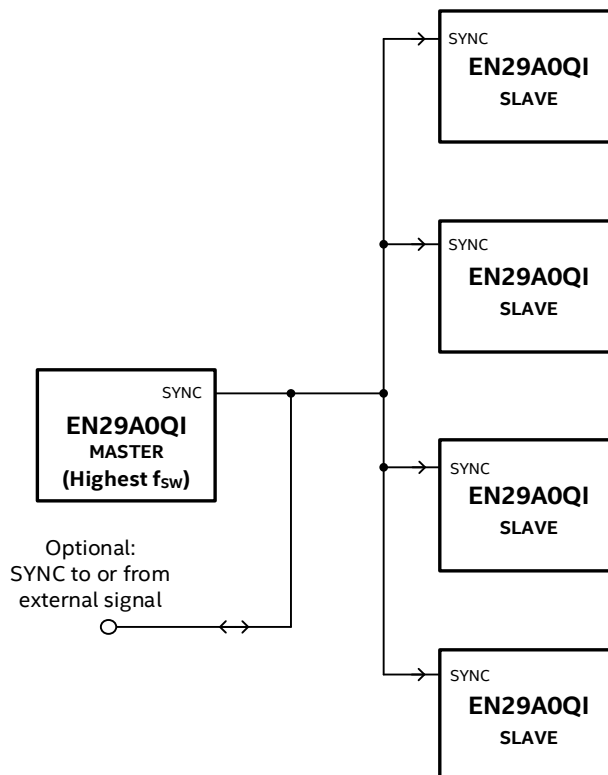

**Figure 5: Frequency synchronization**

Multiple EN29A0QI devices may be connected in a Master/Slave configuration. The device set at the highest free-running frequency is automatically placed in Master mode and becomes the SYNC master. In Master mode, a version of the internal switching oscillator signal is output on the SYNC pin. This PWM signal from the Master is fed to the Slave device at its SYNC pin. The slave device's PWM frequency synchronizes to the PWM frequency on its SYNC pin. The Master device's switching clock may be phase-locked to an external clock source of higher frequency to move the entire system frequency away from sensitive frequencies, in which case all devices are synchronized to the external clock. Additional Slave devices may be synchronized with the Master by connecting the SYNC of the Master to the SYNC of all other Slave devices. Refer to Figure 5 for details. To guarantee a particular device is set as the Master device, set its free-running switching frequency 1% or more higher than that of the remaining devices, after accounting for the tolerance of the  $R_{FREQ}$  resistors. The SYNC pin may be left floating when the frequency synchronization feature is not used.

## Over-Current Protection (OCP)

The EN29A0QI monitors current in the high side and low side MOSFET switches, both sinking and sourcing, to provide comprehensive current monitoring and protection. A proprietary dual threshold current limit scheme is employed. When the peak current exceeds the upper limit threshold, the high-side MOSFET is turned off, the low-side MOSFET is turned on, and PWM is ignored. Once the current ramps down below the lower threshold, the device will respond to PWM once again. This approach guarantees the device will stay within the inductor and MOSFET safe operating area versus a cycle by cycle limit where inductor current can get into a run-away condition. The OCP fault is determined by two timers working in conjunction: an OCP Timer (counting up to 20ms nominally) and an OCP Reset Timer (counting up to 10ms nominally). The OCP Timer is triggered during the first switch cycle that the output current exceeds the OCP trip level, and it starts counting up to 20ms. OCP Timer will count to 20ms and then latch the unit off unless OCP Reset Timer intervenes and resets the count. OCP Reset Timer counts up to 10ms when there is no current limiting. If current limiting occurs it is reset back to zero. Each time the OCP Reset Timer counts up to 10ms it resets the OCP Timer back to zero. Each cycle that the current limit is exceeded, the device will limit the output current by ignoring the PWM command until the current drops below the OCP level or OCP Timer is exceeded. If OCP Timer is exceeded the device will immediately set the shut-down latch: output will tristate and POK will go low. The OCP latch is reset by toggling the enable pin or cycling input power. Note that the OCP magnitude depends on switching frequency and duty ratio. Refer to the Resistor Programmable Frequency section for details on its dependence on switching frequency.

## Over-Temperature Protection (OTP)

When the junction temperature exceeds the thermal shutdown temperature, sensing circuits in the converter will cause the device to set the shut-down latch: output will tristate and POK will go low. The part will exit the OTP latch and restart with a normal soft-start and resume normal operation after the junction temperature drops to a safe operating level if the enable pin is toggled or input power is cycled. The thermal shutdown temperature and hysteresis values can be found in the Thermal Characteristics table.

## Input Under-Voltage Lock-Out (UVLO)

When the input voltage is below a required voltage level ( $V_{UVLOR}$ ) for normal operation, the converter switching is inhibited. The lock-out threshold has hysteresis to prevent chatter. When the device is operating normally, if the input voltage falls below the lower threshold ( $V_{UVLOF}$ ) the output will tri-state and POK will go low. Once a UVLO fault has occurred and the shut-down latch is set, the part will restart with a normal soft-start and resume normal operation if 1) Enable is toggled after the input voltage has gone back up above the upper threshold ( $V_{UVLOR}$ ), or 2) The device's input power is toggled.

## Input Over-Voltage Lock-Out (OVLO)

When the input voltage exceeds nominal voltage level ( $V_{OVLO}$ ) for normal operation, the output will tri-state and POK goes low. The lock-out threshold has hysteresis to prevent chatter. Once an OVLO fault has occurred and the shut-down latch is set, the part will restart with a normal soft-start and resume normal operation if 1) Enable is toggled and the input voltage has fallen back below the lower threshold ( $V_{OVLOF}$ ), or 2) The device's input power is toggled.

## Output Over-Voltage Protection (OVP)

If the same resistor divider ratio as the feedback resistor divider ratio is used for the OV\_SNS pin, the nominal overvoltage trip point is set 10% higher than the nominal set voltage. The OV\_SNS pin may also be directly connected to the VFB pin to avoid redundancy. The over-voltage trip point is set nominally to 10% higher than the programmed output voltage when OV\_SNS is tied to the VFB pin. When using an external resistor divider, the overvoltage trip point is set by the divider ratio which can be computed using the following equation:

$$R_{B1} = \frac{0.66 \times R_{A1}}{V_{OVERVOLTAGE} - 0.66}$$

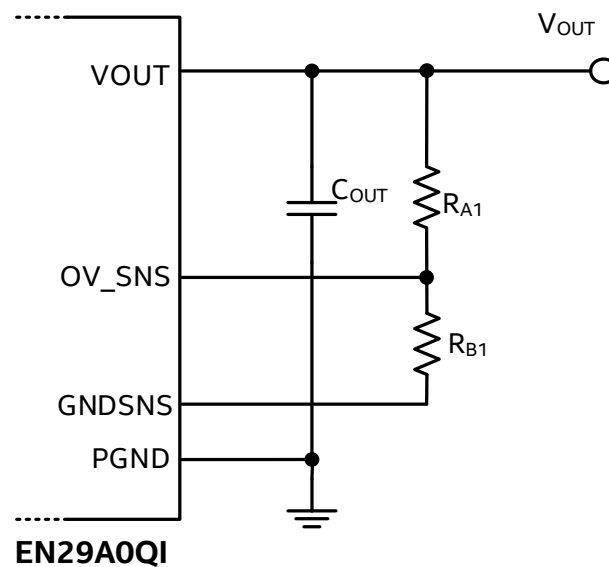

Figure 6: OVP trip-point external resistor divider

When the over-voltage trip point is exceeded the output will tri-state and POK goes low. Once an OVP fault has occurred and the shut-down latch is set, the part will restart with a normal soft-start and resume normal operation if 1) Enable is toggled after the fault is cleared, or 2) The device's input power is cycled.

Connecting the OV\_SNS pin to AGND disables the output over-voltage protection feature.

## Pre-Bias Startup Protection

A pre-biased condition can exist for a number of reasons. Rails with large bulk capacitance which may have insufficient time to discharge, leakage paths from one rail to another, dual/redundant supplies, etc. For pre-bias conditions where the output is below the target voltage the device shall attempt to start switching and regulate the output to the target Vout. The output rate of rise for this condition shall be monotonic within +/-

2% of the rising voltage trajectory. For voltages greater than the target voltage the device shall not respond to the ENABLE signal and will not startup. POK will remain low.

Note that when soft-shutdown is active, the part will pull the pre-bias rail low on shut-down till the Enable lockout time ( $t_{ENLO}$ ) has expired. For applications where this is not desired, it is recommended to leave the STOPCFG open.

## Fault Response Summary

Table 8

Fault condition	Output Response	Other Responses
Vin Under Voltage Lock Out; Vin Falling. (UVLO during VIN rising is not a fault condition, but does ignore the EN pin until VIN crosses the UVLO rising threshold.)	Tristate	Latch off <sup>(1)</sup> POK goes low Discharge SS pin
Vin Over Voltage Lock Out	Tristate	Latch off <sup>(1)</sup> POK goes low Discharge SS pin
Over Temperature Protection	Tristate	Latch off <sup>(1)</sup> POK goes low Discharge SS pin
Vout Over Voltage Protection	Tristate	Latch off <sup>(1)</sup> POK goes low Discharge SS pin
Over Current Protection (subject to OCP Timer and OCP Reset Timer functionality)	Tristate	Latch off <sup>(1)</sup> POK goes low Discharge SS pin

<sup>(1)</sup> Requires enable pin toggle or input power cycle to clear fault after fault condition is removed.



## APPLICATION INFORMATION

### Output Voltage Setting

The EN29A0QI output voltage is programmed using a simple resistor divider network ( $R_A$  and  $R_B$ ). Figure 7 shows the resistor divider configuration.

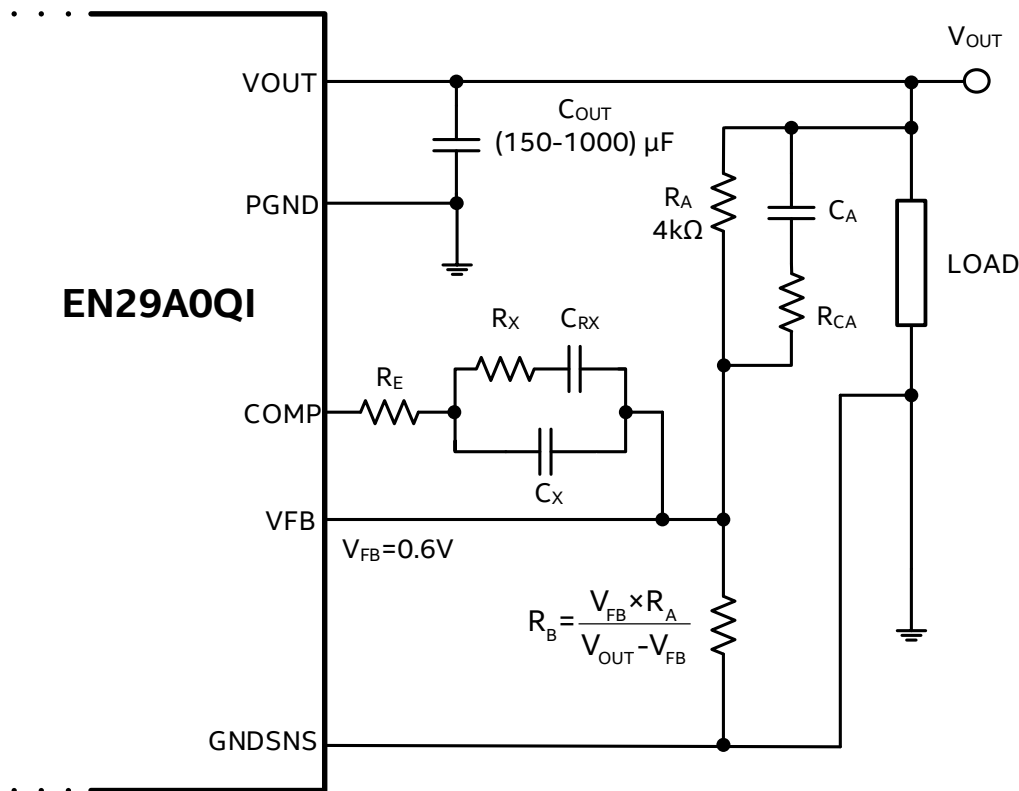

**Figure 7: VOUT Resistor Divider & Compensation Network**

The recommended  $R_A$  resistor value is  $4\text{k}\Omega$  and the feedback voltage is typically  $0.6\text{V}$ . Depending on the output voltage ( $V_{OUT}$ ), the  $R_B$  resistor value may be calculated as shown in Figure 7. Since the accuracy of the output voltage setting is dependent upon the feedback voltage and the external resistors, 1% or better resistors are recommended. The external compensation capacitor ( $C_A$ ) and resistor ( $R_{CA}$ ) is also required in parallel with  $R_A$ . Table 9 shows external compensation recommendations for a minimum footprint solution and for optimized transient response for different output voltages at  $V_{IN} = 12\text{V}$ .

**Table 9: External Compensation Recommendations**

CONFIGURATION	VOUT (V)	$R_A$ (k $\Omega$ )	$C_A$ (pF)	$R_{CA}$ ( $\Omega$ )	$R_X$ (k $\Omega$ )	$C_X$ (pF)	$C_{RX}$ (pF)	$C_{OUT}$ ( $\mu\text{F}$ )
Minimum size	$0.75 \leq V_{OUT} \leq 3.3$	4	680	150	4	10	1000	3 x 47 (1206)
Optimized transient response	$0.75 \leq V_{OUT} \leq 1.5$	4	470	150	10	10	1000	4 x 47 (1206) + 470
	$1.5 < V_{OUT} \leq 2.5$	4	330	150	10	10	1000	4 x 47 (1206) + 470
	$2.5 < V_{OUT} \leq 3.3$	4	330	150	15	10	1000	4 x 47 (1206) + 470

When remote sensing is desired, the GNDSNS trace and the VOUT trace leading to the compensation network must be tapped from closest to the load. If remote sensing is not used, these traces are tapped from the local ceramic filter capacitor. The GNDSNS pin may also be tied to PGND close to the part when remote sense is not used.

## Compensation and Transient Response

The EN29A0QI uses an Type III compensation for optimizing stability and transient response. The error amplifier’s input (VFB) and output (COMP) pins are directly accessible to allow for direct tuning of the compensation network, as shown in Figure 7. Some standard compensation values are provided in Table 9. A downloadable compensation calculation tool is also provided at EN29A0QI’s product page at [www.altera.com/enpirion](http://www.altera.com/enpirion) for easier calculation and optimization of the compensation components. This tool also provides the option of selecting Type IV compensation network, an enhanced version of type III compensation, to provide excellent transient response where desired. For applications where Type IV is not desired or needed, the  $R_E$  resistor may be set to  $0\Omega$ .

## Input Capacitor Selection

The input of synchronous buck regulators can be very noisy and should be decoupled properly in order to ensure stable operation. In addition, input line inductance can contribute to higher input voltage ripple. The EN29A0QI requires a minimum of 3 x 22 $\mu$ F input capacitors. As the distance of the input power source to the input of the EN29A0QI is increased, it is recommended to increase input capacitance in order to mitigate the line inductance from the source. The type of capacitance that is used can vary greatly. Low-cost, low-ESR ceramic capacitors should be used. The dielectric must be X5R or X7R rated. Y5V or equivalent dielectric formulations must not be used as these lose too much capacitance with frequency, temperature and bias voltage. In some applications, lower value capacitors are needed in parallel with the larger capacitors in order to provide high frequency decoupling. Larger electrolytic or tantalum bulk capacitors may be used in conjunction to increase total input capacitance but should not be used solely as a replacement for the ceramic capacitors.

**Table 10: Recommended Input Capacitors**

Description	MFG	P/N
22 $\mu$ F $\pm$ 10%, 25V, X5R, 1210	Murata	GRM32ER61E226KE15K
	TDK	C3225X5R1E226K250AC

## Output Capacitor Selection

The output ripple of synchronous buck converters can be attributed to its inductance, switching frequency and output decoupling. The EN29A0QI requires a minimum of 3 x 47 $\mu$ F output capacitors. Low ESR ceramic capacitors are required with X5R or X7R rated dielectric formulation. Y5V or equivalent dielectric formulations must not be used as these lose too much capacitance with frequency, temperature and bias voltage.

## Output Ripple

Output ripple voltage is determined by the aggregate output capacitor impedance. Output impedance, denoted as Z, is comprised of effective series resistance (ESR) and effective series inductance (ESL):

$$Z = ESR + ESL$$

The resonant frequency of a ceramic capacitor is inversely proportional to the capacitance. Lower capacitance corresponds to higher resonant frequency. When two capacitors are placed in parallel, the benefit of both are combined. It is beneficial to decouple the output with capacitors of various capacitance and size.

A graphical tool, located at <https://www.altera.com/support/support-resources/support-centers/signal-power-integrity/power-distribution-network.html>, helps model and optimize the Power Distribution Network for Intel FPGAs.

**Table 11: Recommended Output Capacitors**

Description	MFG	P/N
47µF ±20%, 6.3V, X5R, 1206	Taiyo Yuden	JMK316BJ476ML-T
	Murata	GRM31CR60J476ME19L
	TDK	JMK316BJ476MD-T

## THERMAL CONSIDERATIONS

Thermal considerations are important power supply design facts that cannot be avoided in the real world. Whenever there are power losses in a system, the heat that is generated by the power dissipation needs to be accounted for. The Intel Enpirion PowerSoC helps alleviate some of those concerns.

The Intel Enpirion EN29A0QI DC-DC converter is packaged in a 12x14x4mm 84-pin QFN package. The QFN package is constructed with copper lead frames that have exposed thermal pads. The exposed thermal pad on the package should be soldered directly on to a copper ground pad on the printed circuit board (PCB) to act as a heat sink. The recommended maximum junction temperature for continuous operation is 125°C. Continuous operation above 125°C may reduce long-term reliability. The device has a thermal overload protection circuit designed to turn off the device at an approximate junction temperature value of 150°C.

The following example and calculations illustrate the thermal performance of the EN29A0QI.

Example:

$$V_{IN} = 12V$$

$$V_{OUT} = 1.05V$$

$$I_{OUT} = 10A$$

First calculate the output power.

$$P_{OUT} = 1.05V \times 10A = 10.5W$$

Next, determine the input power based on the efficiency ( $\eta$ ) shown in Figure 8.

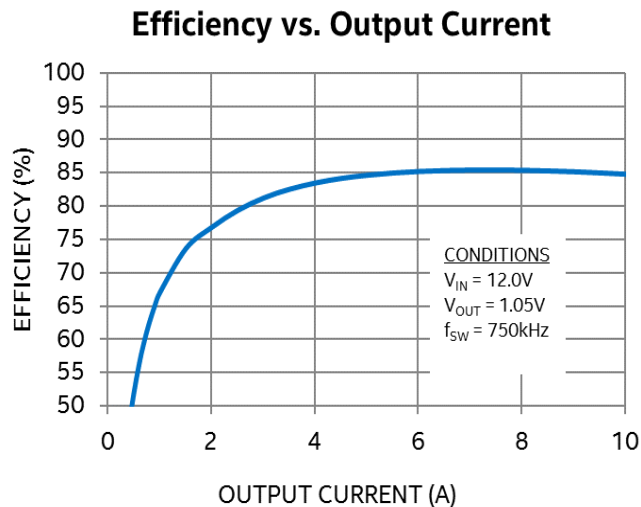

**Figure 8: Efficiency vs. Output Current**

For  $V_{IN} = 12V$ ,  $V_{OUT} = 1.05V$  at 10A,  $\eta \approx 85\%$

$$\eta = P_{OUT} / P_{IN} = 85\% = 0.85$$

$$P_{IN} = P_{OUT} / \eta$$

$$P_{IN} \approx 10.5W / 0.85 \approx 12.35W$$

The power dissipation ( $P_D$ ) is the power loss in the system and can be calculated by subtracting the output power from the input power.

$$P_D = P_{IN} - P_{OUT}$$

$$\approx 12.35W - 10.5 \approx 1.85W$$

With the power dissipation known, the temperature rise in the device may be estimated based on the theta JA value ( $\theta_{JA}$ ). The  $\theta_{JA}$  parameter estimates how much the temperature will rise in the device for every watt of power dissipation. The EN29A0QI has a  $\theta_{JA}$  value of 10°C/W without airflow.

Determine the change in temperature ( $\Delta T$ ) based on  $P_D$  and  $\theta_{JA}$ .

$$\Delta T = P_D \times \theta_{JA}$$

$$\Delta T \approx 1.85W \times 10^\circ\text{C}/W = 18.5^\circ\text{C} \approx 19^\circ\text{C}$$

The junction temperature ( $T_J$ ) of the device is approximately the ambient temperature ( $T_A$ ) plus the change in temperature. We assume the initial ambient temperature to be 25°C.

$$T_J = T_A + \Delta T$$

$$T_J \approx 25^\circ\text{C} + 19^\circ\text{C} \approx 44^\circ\text{C}$$

The maximum operating junction temperature ( $T_{JMAX}$ ) of the device is 125°C, so the device can operate at a higher ambient temperature. The maximum ambient temperature ( $T_{AMAX}$ ) allowed can be calculated.

$$T_{AMAX} = T_{JMAX} - P_D \times \theta_{JA}$$

$$\approx 125^\circ\text{C} - 19^\circ\text{C} \approx 106^\circ\text{C}$$

The maximum ambient temperature the device can reach is 106°C given the input and output conditions. Note that the efficiency used in this example is at 25°C ambient temperature. Refer to the de-rating curves in the Typical Performance Curves section.

*Note: Thermal Characteristics its is based on a 4-layer PCB, with 2oz. external copper layers and proper thermal design in line with EIJ/JEDEC JESD51-7 standard for high thermal conductivity boards.*

## APPLICATION CIRCUITS

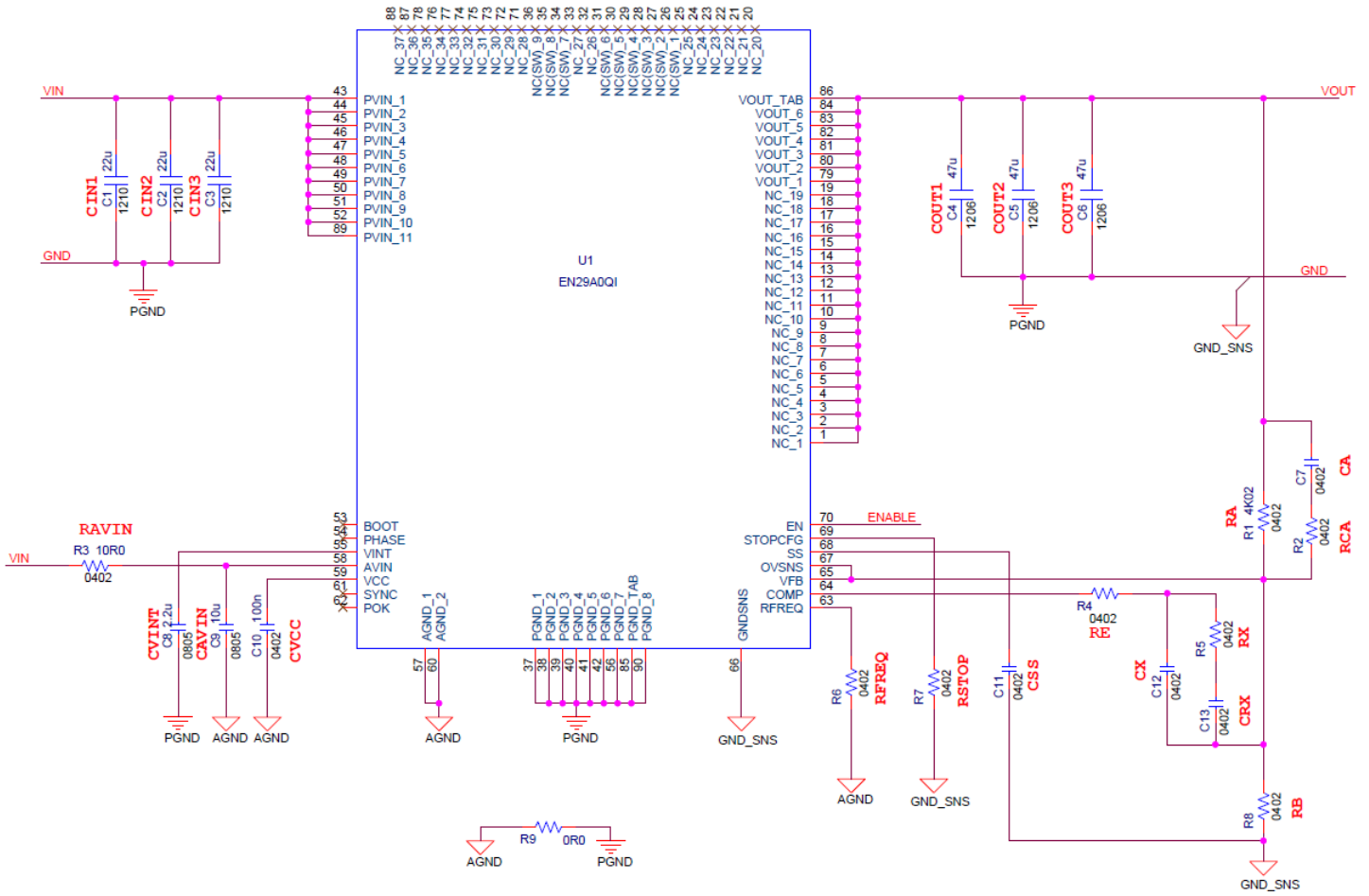

Figure 9: Typical Application Circuit

## LAYOUT RECOMMENDATIONS

Figures 10-13 shows critical components and traces of a recommended minimum footprint EN29A0QI layout. The Gerber files are available on the Altera website [www.altera.com/enpirion](http://www.altera.com/enpirion) for exact dimensions. Please refer to Figure 9 for the corresponding schematic.

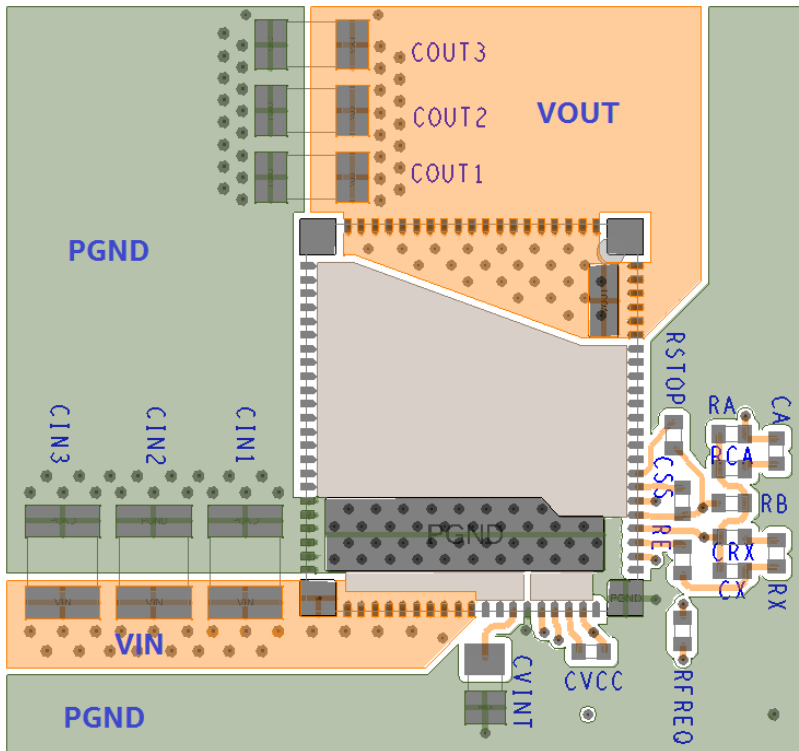

Figure 10: Top PCB Layer Critical Components and Copper for Minimum Footprint (Top View)

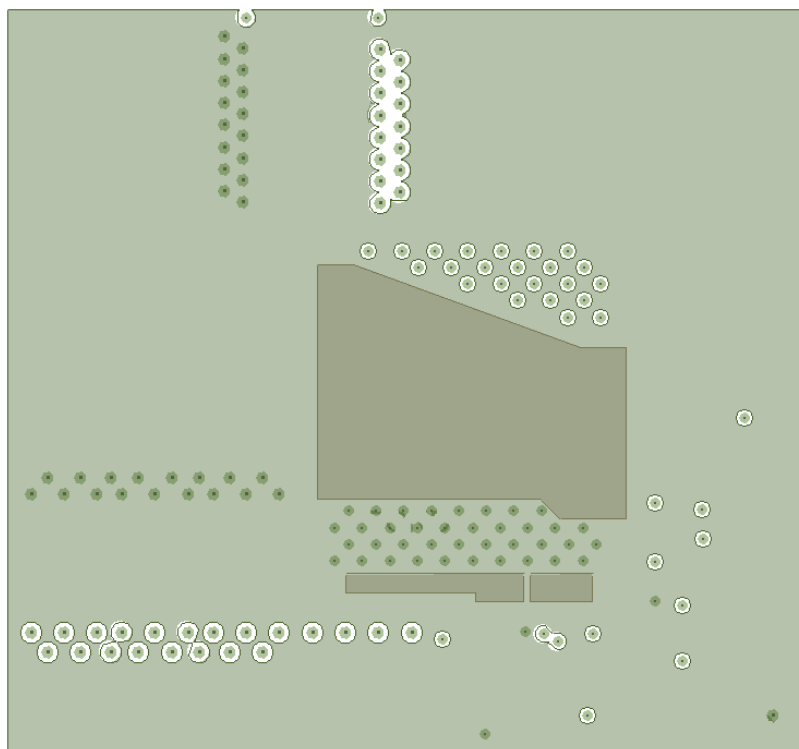

Figure 11: Inner Layer 2 – PGND

**Recommendation 1:** Input and output filter capacitors should be placed on the same side of the PCB, and as close to the EN29A0QI package as possible. They should be connected to the device with very short and wide traces. Do not use thermal reliefs or spokes when connecting the capacitor pads to the respective nodes. The +V and GND traces between the capacitors and the EN29A0QI should be as close to each other as possible so that the gap between the two nodes is minimized, even under the capacitors.

**Recommendation 2:** The system ground plane should be on the 2<sup>nd</sup> layer below the surface layer. This ground plane should be continuous and un-interrupted below the converter and the input/output capacitors. Please see the Gerber files on the Altera website [www.altera.com/enpirion](http://www.altera.com/enpirion).

**Recommendation 3:** The large thermal pad (Pin 85) and the VOUT thermal pad (Pin 86) underneath the device must be connected to the system ground plane and the VOUT plane respectively, through as many vias as possible. The drill diameter of the vias should be 0.33mm, and the vias must have at least 1 oz. copper plating on the inside wall, making the finished hole size around 0.20-0.26mm. Do not use thermal reliefs or spokes to connect the vias to the ground plane. This connection provides the path for heat dissipation from the converter.

**Recommendation 4:** The corner pads (Pins 87-90) are not connected internally and maybe connected to nearby planes for ease of layout. Figure 9 and Figure 10 show Pin 89 connected to the VIN plane and Pin 90 connected to the PGND plane.

**Recommendation 5:** Multiple small vias (the same size as the thermal via discussed in recommendation 3) should be used to connect ground terminal of the input capacitor and output capacitors to the system ground plane. It is preferred to put these vias under the capacitors along the edge of the GND copper closest to the +V copper. These vias connect the input/output filter capacitors to the GND plane, and help reduce parasitic inductances in the input and output current loops. If the vias cannot be placed under  $C_{IN}$  and  $C_{OUT}$ , then put them just outside the capacitors. Do not use thermal reliefs or spokes to connect these vias to the ground plane.

**Recommendation 6:** AVIN is the power supply for the internal small-signal control circuits. It should be connected to the input voltage at a quiet point through a RC circuit ( $R_{AVIN}$  and  $C_{AVIN}$ ). In Figure 13 this connection to  $R_{AVIN}$  is made at the input capacitor close to the  $V_{IN}$  connection on the input source side. Avoid connecting AVIN near the PVIN pin even though it is the same node as the input ripple is higher there.

**Recommendation 7:** The  $V_{OUT}$  sense point should be just after the last output filter capacitor. Keep the sense trace as short as possible in order to avoid noise coupling into the control loop. If remote sensing is desired, the  $V_{OUT}$  sense point and the GNDSNS point must be closest to the load.

**Recommendation 8:** Keep  $R_A$ ,  $C_A$ ,  $R_{CA}$ ,  $R_X$ ,  $C_X$ ,  $R_{CX}$  and  $R_B$  close to the VFB pin (see Figure 10). Keep the trace to VFB pin as short as possible. Whenever possible, connect  $R_B$  directly to the GNDSNS pin instead of going through the GND plane. The AGND should connect to the PGND at a single point from the AGND pin to the 3<sup>rd</sup> layer PGND plane (shown in Figure 12).

**Recommendation 9:** The layer 1 metal under the device must not be more than shown in Figure 10. See the following section regarding **Exposed Metal on Bottom of Package**. As with any switch-mode DC/DC converter, try not to run sensitive signal or control lines underneath the converter package on other layers.



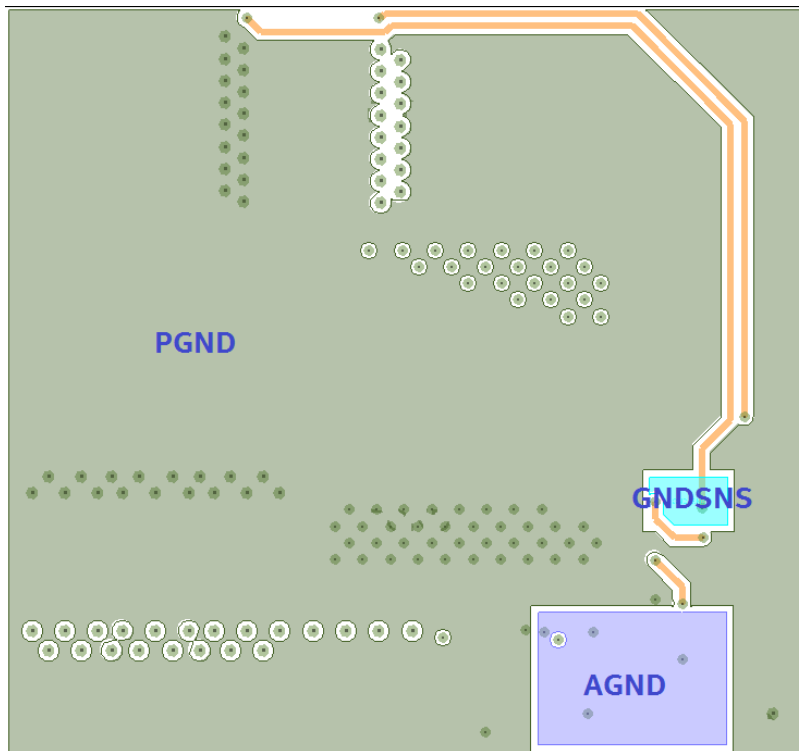

Figure 12: Inner Layer 3 – Grounds

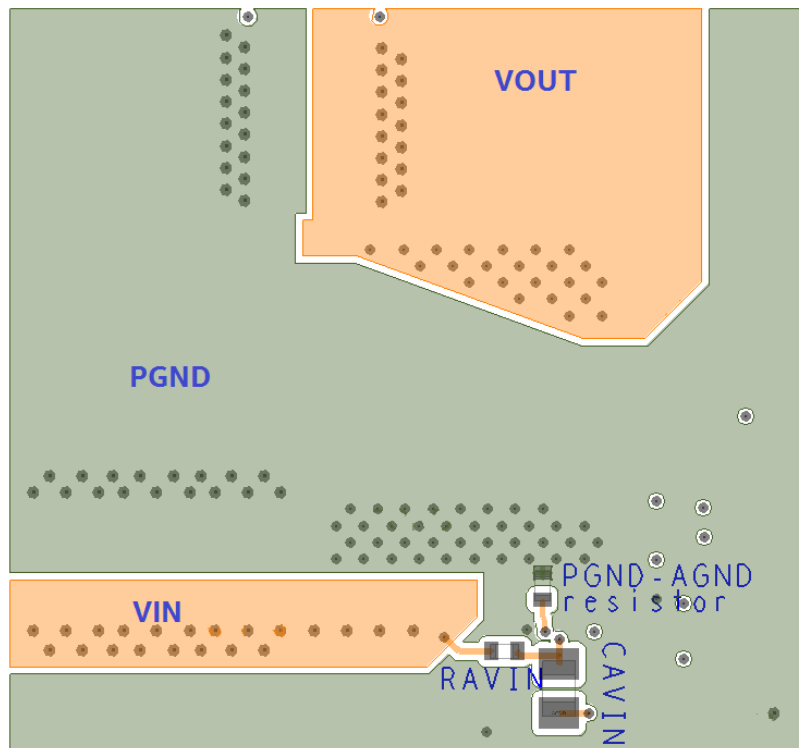

Figure 13: Bottom Layer

# DESIGN CONSIDERATIONS FOR LEAD-FRAME BASED MODULES

## Exposed Metal on Bottom of Package

Lead-frames offer many advantages in thermal performance, in reduced electrical lead resistance, and in overall foot print. However, they do require some special considerations.

In the assembly process lead frame construction requires that, for mechanical support, some of the lead-frame cantilevers be exposed at the point where wire-bond or internal passives are attached. This results in several small pads being exposed on the bottom of the package, as shown in Figure 14.

Only the thermal pad and the perimeter pads are to be mechanically or electrically connected to the PCB. The PCB top layer under the EN29A0QI should be clear of any metal (copper pours, traces, or vias) except for the thermal pad. The “shaded-out” area in Figure 14 represents the area that should be clear of any metal on the top layer of the PCB. Any layer 1 metal under the shaded-out area runs the risk of undesirable shorted connections even if it is covered by soldermask.

The solder stencil aperture should be smaller than the PCB ground pad. This will prevent excess solder from causing bridging between adjacent pins or other exposed metal under the package. Please consult the General QFN Package Soldering Guidelines for more details and recommendations.

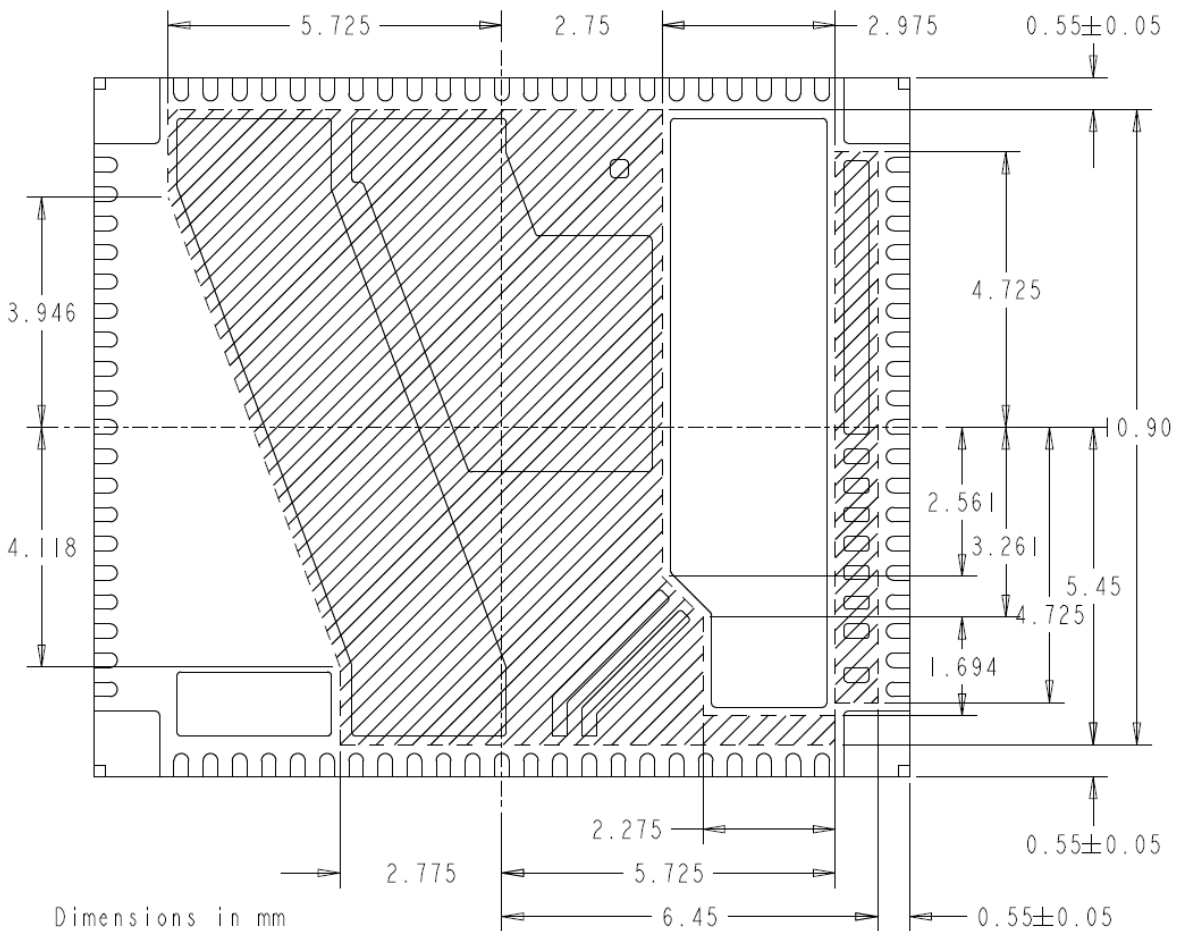
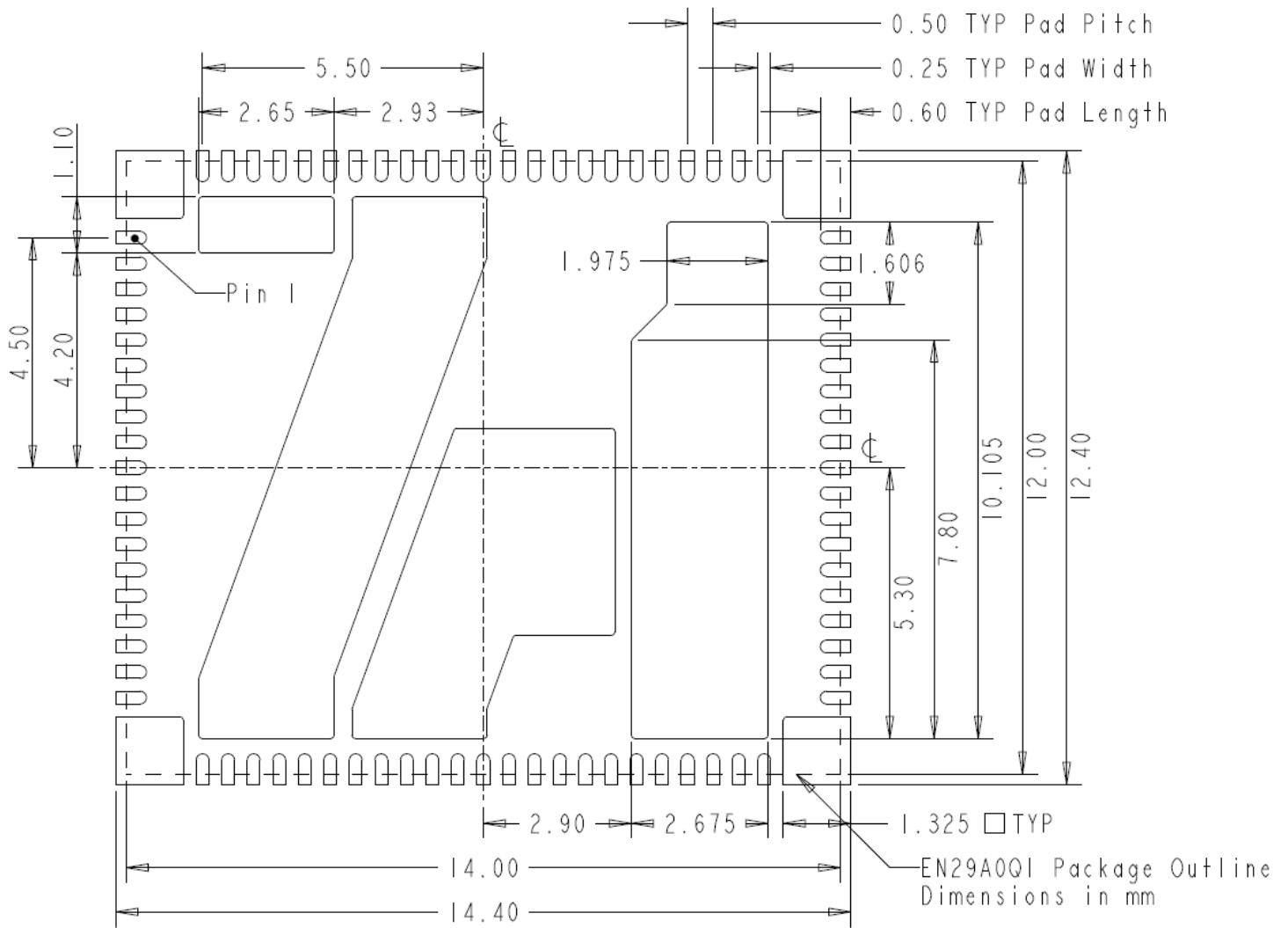

Figure 14: Lead-Frame exposed metal (Bottom View)

Shaded area highlights exposed metal that is not to be mechanically or electrically connected to the PCB.



**Figure 15: Landing Pattern with Solder Stencil (Top View)**

The solder stencil aperture for the thermal PGND pad is shown in Figure 15 and is based on Enpirion power product manufacturing specifications.

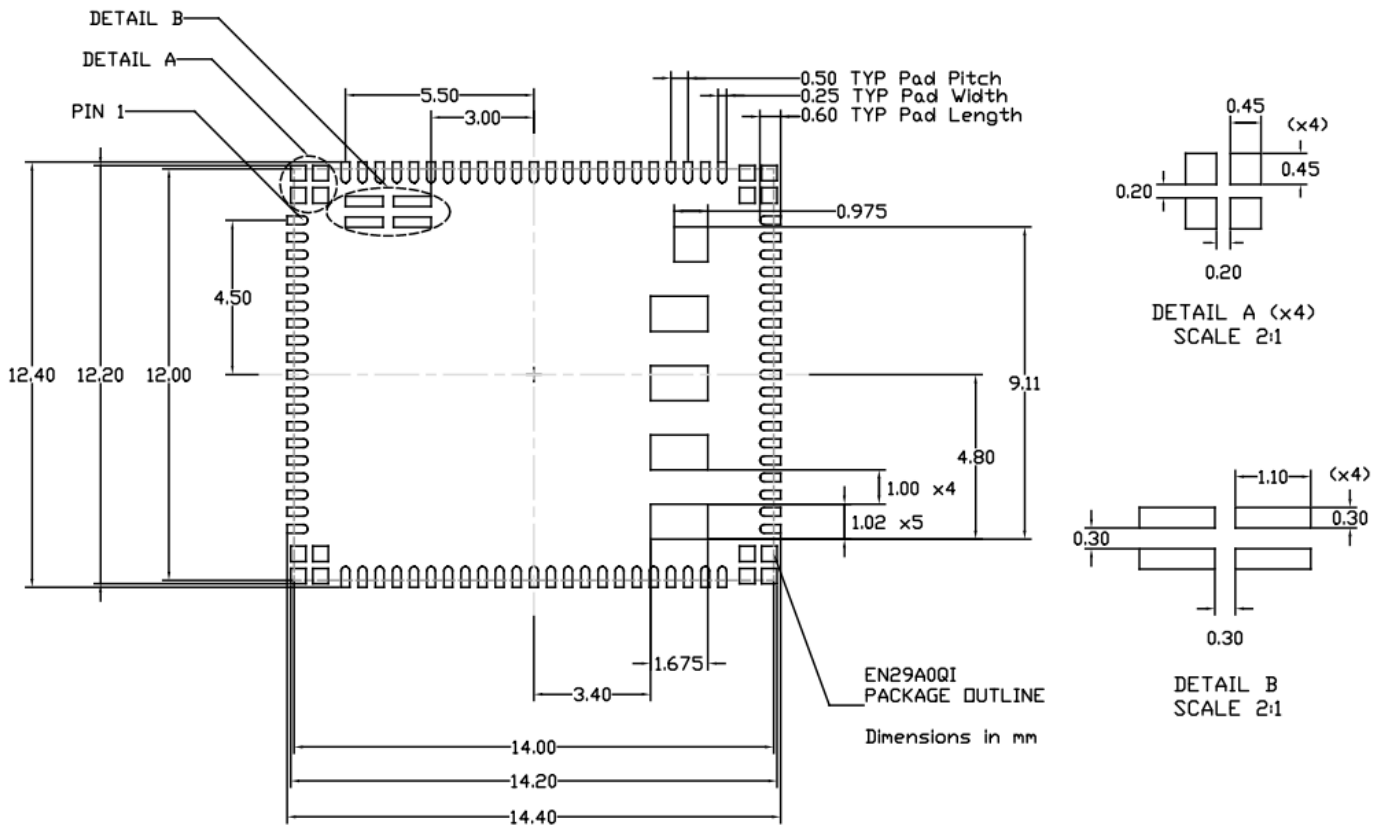
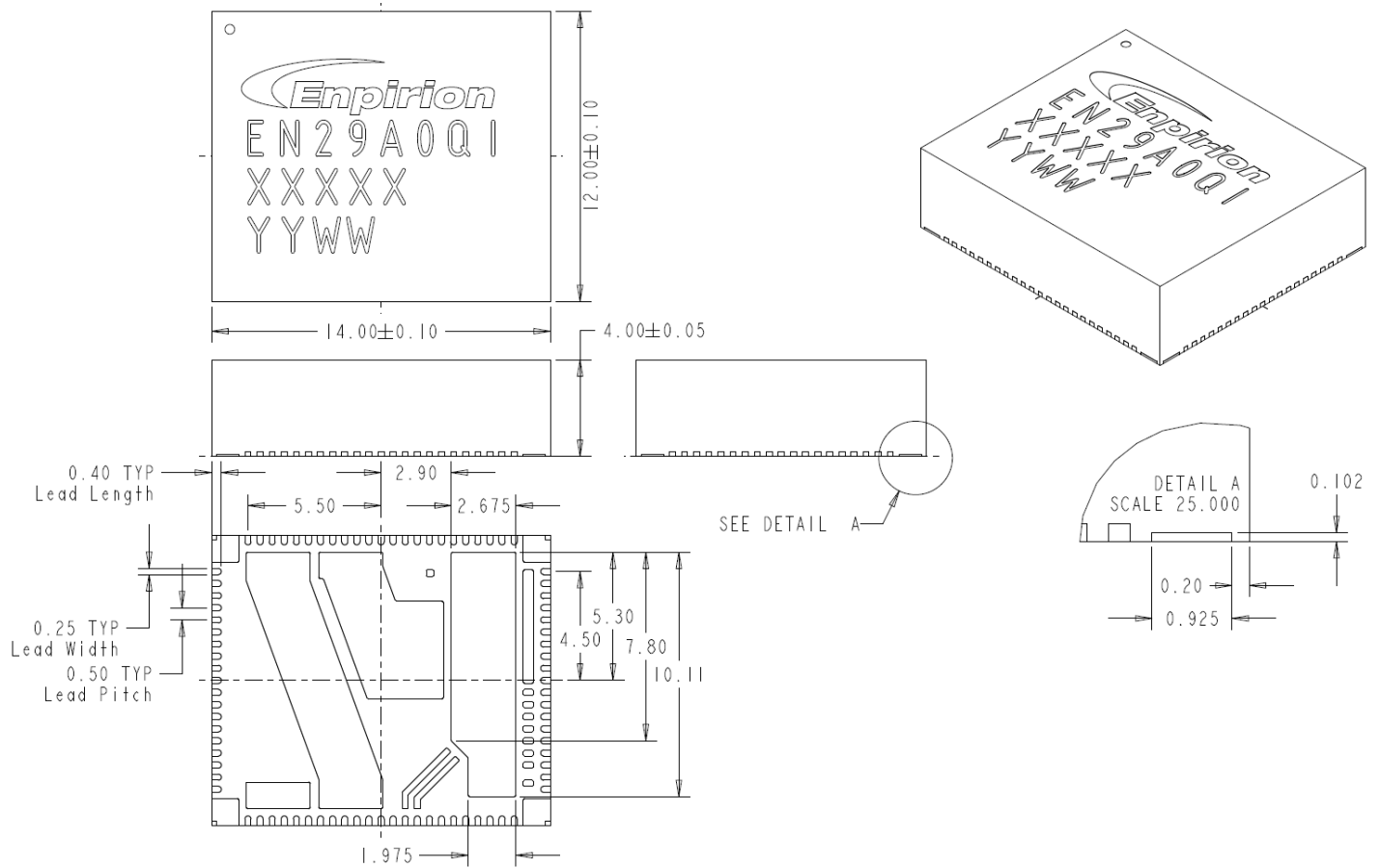

Figure 16: Solder Stencil Drawing

# PACKAGE DIMENSIONS



**Figure 17: EN29A0QI Package Dimensions**

**Packing and Marking Information:** <https://www.altera.com/support/quality-and-reliability/packing.html>

## REVISION HISTORY

Rev	Date	Change(s)
A	Mar, 2018	<ul style="list-style-type: none"><li>• Initial Release</li></ul>
B	Jun, 2018	<ul style="list-style-type: none"><li>• Updated MSL rating from MSL4 to MSL3</li><li>• Updated thermal ratings to reflect junction temperature rating (125°C)</li><li>• Updated Electrical characteristics table (EN Hysteresis and Soft-start discharge resistance) maximum ratings to reflect data at T<sub>J</sub>=125°C</li><li>• Updated keep-out and landing pattern diagrams to show additional dimensions (Figures 14, 15)</li></ul>
C	Sep, 2018	<ul style="list-style-type: none"><li>• Replaced EMI charts</li></ul>

## WHERE TO GET MORE INFORMATION

For more information about Intel and Intel Enpirion PowerSoCs, visit:

<https://www.altera.com/products/power/overview.html>