



ABSTRACT

This user's guide describes the characteristics, operation, and use of the OPT4001YMNEVM evaluation module. It discusses how to set up and configure the software and hardware, and reviews various aspects of the program operation. Throughout this document, the terms evaluation board, evaluation module, and EVM are synonymous with the OPT4001YMNEVM. This document also includes an electrical schematic, printed circuit board (PCB) layout drawings, and a parts list for the EVM.

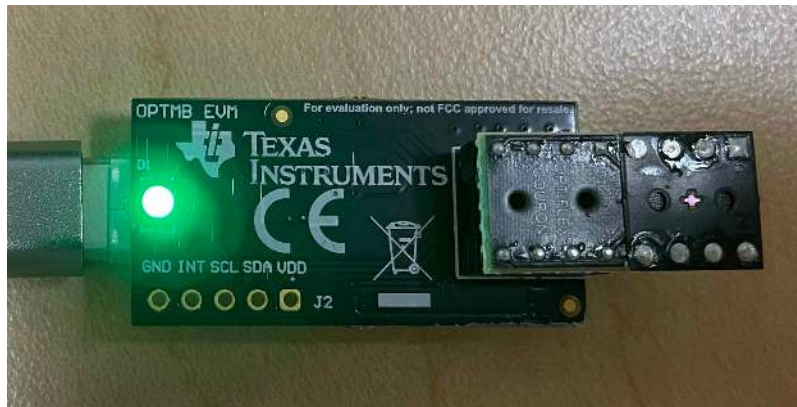

Table of Contents

1 Overview	3
1.1 OPT4001YMNEVM Kit Contents.....	3
1.2 Related Documentation from Texas Instruments.....	4
2 OPT4001YMNEVM Hardware	5
2.1 Theory of Operation for the OPT4001YMNEVM.....	6
2.2 OPT4001YMNEVM Hardware Overview.....	6
3 OPT4001YMNEVM Software	7
3.1 Hardware Requirements.....	7
3.2 Software Installation.....	7
3.3 Typical OPT4001YMNEVM Hardware Setup.....	11
3.4 Launching the OPT4001EVM Software.....	13
3.5 OPT4001EVM Software Operation.....	14
4 Schematic, PCB Layout, and Bill of Materials	19
4.1 Flex Coupon Board.....	19
4.2 Rigid Coupon Board.....	21
4.3 Motherboard.....	24
5 Troubleshooting	28
5.1 Microsoft Windows 7 Manual Driver Installation.....	28

List of Figures

Figure 1-1. Hardware Included with OPT4001YMNEVM Kit.....	3
Figure 2-1. EVM Hardware Setup.....	5
Figure 3-1. OPT4001YMNEVM Software-Installation File.....	7
Figure 3-2. OPT4001YMNEVM Software-Installation Launch.....	8
Figure 3-3. OPT4001YMNEVM Software-Installation Prompts.....	8
Figure 3-4. OPT4001YMNEVM Software-Installation Prompts.....	9
Figure 3-5. OPT4001YMNEVM Software-Installation Prompts.....	9

Figure 3-6. OPT4001YMNEVM Software-Installation Prompts.....	10
Figure 3-7. OPT4001YMNEVM Software-Installation Prompts.....	10
Figure 3-8. OPT4001YMNEVM Software-Installation Prompts.....	11
Figure 3-9. Typical Hardware Connection.....	11
Figure 3-10. Typical Response After Connecting OPT4001YMNEVM to the Computer.....	12
Figure 3-11. OPT4001 Main Operation Screen.....	13
Figure 3-12. Hardware Error Message.....	13
Figure 3-13. GUI Capture Running.....	14
Figure 3-14. Latte Scripts Window.....	16
Figure 3-15. Registers View.....	17
Figure 4-1. OPT4001YMNEVM construction.....	19
Figure 4-2. OPT4001 Flex Coupon Board Schematic.....	19
Figure 4-3. PCB Top Layer.....	20
Figure 4-4. PCB Bottom Layer.....	20
Figure 4-5. PCB Top-Layer Assembly Drawing.....	20
Figure 4-6. PCB Bottom-Layer Assembly Drawing.....	20
Figure 4-7. OPT4001 Coupon Rigid Board Schematic.....	21
Figure 4-8. PCB Top Layer.....	22
Figure 4-9. PCB Bottom Layer.....	22
Figure 4-10. PCB Top-Layer Assembly Drawing.....	22
Figure 4-11. PCB Bottom-Layer Assembly Drawing.....	23
Figure 4-12. OPTMBEVM Schematic.....	24
Figure 4-13. PCB Top Layer.....	25
Figure 4-14. PCB Bottom Layer.....	25
Figure 4-15. PCB Top-Layer Assembly Drawing.....	26
Figure 4-16. PCB Bottom-Layer Assembly Drawing.....	26
Figure 5-1. OPT4001YMNEVM on Microsoft® Windows® 7 With Drivers not Installed.....	28

Trademarks

Windows 10®, Microsoft®, and Windows® are registered trademarks of Microsoft Corporation. All trademarks are the property of their respective owners.

1 Overview

The **OPT4001** is an ambient light sensor (ALS) with a digital output integrated circuit. It uses a two-wire interface that works with the I²C protocol making it ideal for many applications. The OPT4001YMN is the picostar package version of the OPT4001 device. The picostar package achieves very small size and thickness and orients with the photodiode facing down and senses light through a cutout in the board. This requires the sensor be soldered to a flex PCB in most applications to maximize the field of view of the sensor. The OPT4001YMNEVM is a platform for evaluating the performance of the OPT4001 under various conditions. The OPT4001YMNEVM consists of two PCBs. The first is the OPTMB EVM board, which is a motherboard. This board communicates with a computer through USB connection and provides power and sends and receives appropriate digital signals with the **OPT4001** IC. The motherboard will relay USB commands from the EVM GUI software running on the PC to the **OPT4001** IC through I²C. The second is the OPT4001YMN coupon board, which contains the OPT4001YMN and its support circuitry. The coupon board consists of a flex PCB soldered to a rigid board. This allows the coupon to be easily plugged and unplugged as the rigid board adds strength to the flex board.

1.1 OPT4001YMNEVM Kit Contents

Table 1-1 summarizes the contents of the OPT4001YMNEVM kit. **Figure 1-1** shows the included hardware. Contact the [Texas Instruments Product Information Center](#) nearest you if any component is missing. It is highly recommended that you also check the [OPT4001YMN product folder](#) on the TI web site at www.ti.com to verify you have the latest versions of the released software.

Table 1-1. OPT4001YMNEVM Kit Contents

Item	Quantity
OPT4001 coupon board (Installed on OPTMBEVM)	1
OPTMBEVM board	1
USB type A to type C cable	1



Figure 1-1. Hardware Included with OPT4001YMNEVM Kit

1.2 Related Documentation from Texas Instruments

The following documents provide information regarding Texas Instruments' integrated circuits used in the assembly of the OPT4001YMNEVM. This user's guide is available from the TI web site under literature number **SBOU278**. Any letter appended to the literature number corresponds to the document revision that is current at the time of the writing of this document. The latest revision can be found by clicking the link [Table 1-2](#) and is also available from the [TI web site](#), the Texas Instruments' Literature Response Center at (800) 477-8924, and the Product Information Center at (972) 644-5580. When ordering, identify the document by both title and literature number.

Table 1-2. Related Documentation

Document	Literature Number
OPT4001 product data sheet	SBOS993

2 OPT4001YMNEVM Hardware

Figure 2-1 shows the system setup for the OPT4001YMNEVM. The computer runs the graphical user interface (GUI) software that communicates with the OPTMBEVM board over a USB connection. The OPTMBEVM has a USB Type C port and ships with a USB-C to USB-A cable. The OPTMBEVM board acts as a bridge between the software running on the PC and the OPT4001YMN coupon board. The MSP430 on the OPTMBEVM receives USB commands from the PC and communicates with the OPT4001YMN over I2C.

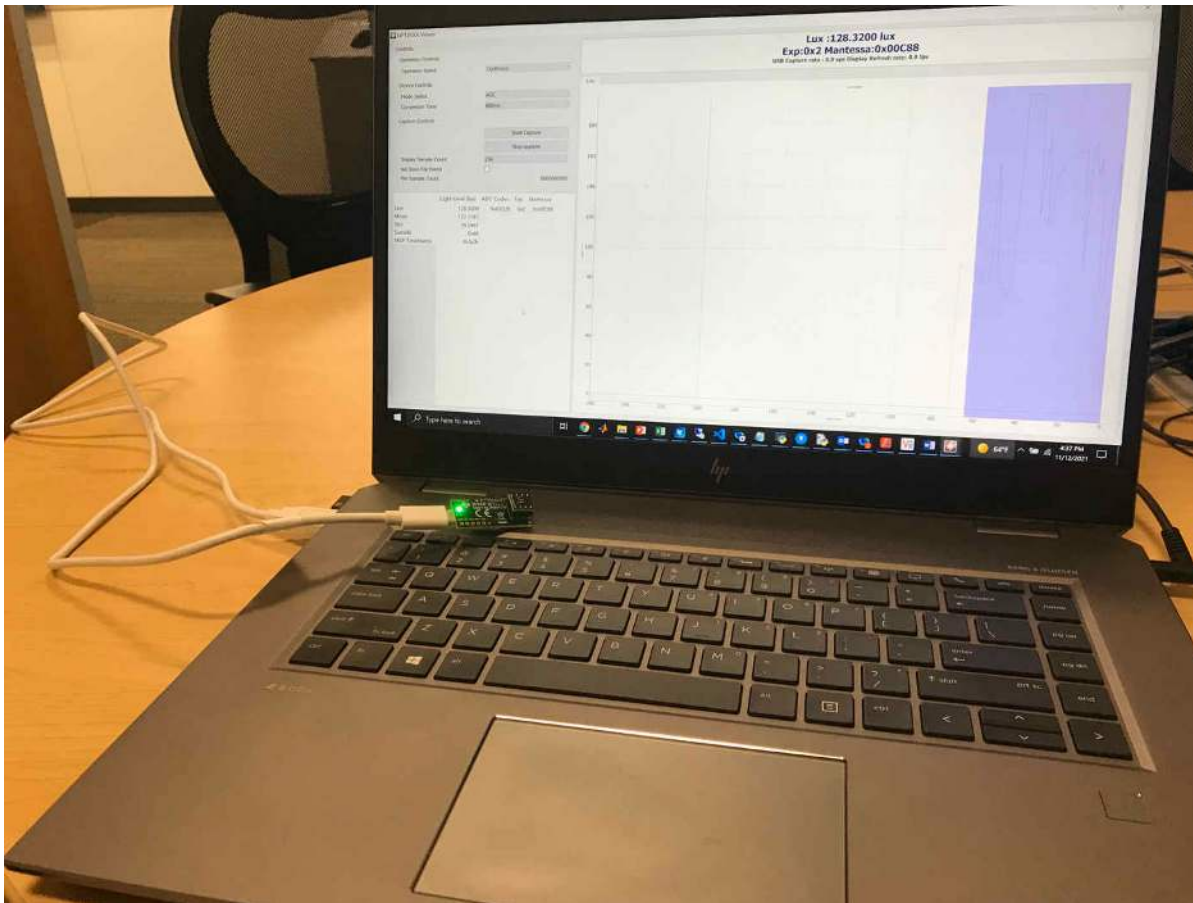

Figure 2-1. EVM Hardware Setup

2.1 Theory of Operation for the OPT4001YMNEVM

The OPT4001 coupon consists of the OPT4001 IC, decoupling capacitor, and 8 pins. The pins create connections for the power and I²C signals between the coupon and the EVM motherboard. For evaluation purposes the coupon can be removed from the motherboard to be used with other platforms. The motherboard also has an unpopulated 5-pin header footprint for easy access to the supply, ground, and I2C lines.

2.2 OPT4001YMNEVM Hardware Overview

The EVM ships with the coupon plugged into the motherboard. If not already assembled, the basic hardware setup for the OPT4001YMNEVM involves plugging the coupon board into the motherboard socket. Take special care to make sure the coupon is oriented correctly as shown in [Figure 1-1](#). Also note the warnings below. Specifically that the flex part of the coupon should not be pressed on. If unplugging and replugging the coupon into the motherboard, the coupon should only be handled by the rigid part and no part of the flex should be pressed on. Then connect the USB cable.

CAUTION

This EVM contains a flex PCB on which the OPT4001 IC is mounted. Flex PCBs are sensitive and should be handled with extra care. Special caution should be given not to press on the flex PCB as this can cause the EVM to break.

CAUTION

Many of the components on the OPT4001YMNEVM are susceptible to damage by electrostatic discharge (ESD). Customers are advised to observe proper ESD handling precautions when unpacking and handling the EVM, including the use of a grounded wrist strap at an approved ESD workstation.

3 OPT4001YMNEVM Software

This section describes the installation and operation of the OPT4001YMNEVM software. The OPT4001YMNEVM uses the TI Latte software, which is available for download on the EVM page.

3.1 Hardware Requirements

The OPT4001EVM software has been tested on the Windows 10® operating system (OS) with United States regional settings. The software should function correctly on other Windows operating systems.

3.2 Software Installation

The OPT4001YMNEVM software is available through the [OPT4001YMNEVM Product Folder](#) on the TI web site (www.ti.com). To install the software to your computer, navigate to the OPT4001YMNEVM software, and open the installer directory. Launch the OPT4001YMNEVM installation file, *OPT4001YMNEVM_GUI.exe*, as shown in the figure below.



Figure 3-1. OPT4001YMNEVM Software-Installation File

The OPT4001EVM software then begins the installation process, as shown in [Figure 3-2](#).

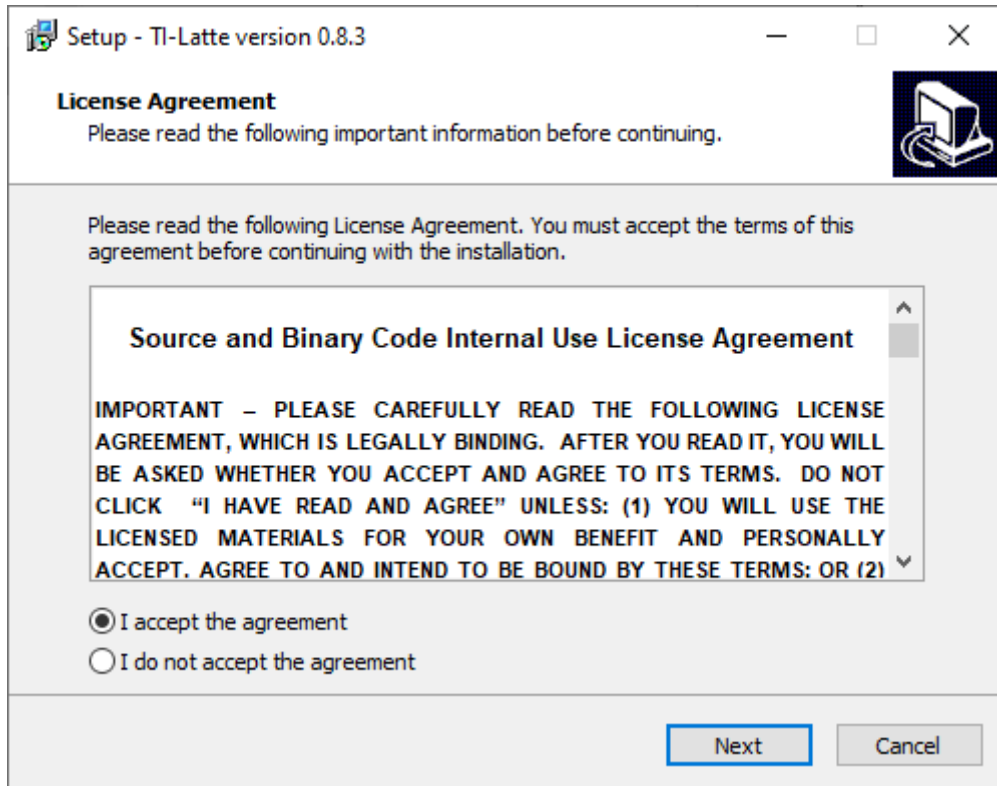

Figure 3-2. OPT4001YMNEVM Software-Installation Launch

Follow the prompts as shown in [Figure 3-3](#) to [Figure 3-8](#) to install the OPT4001YMNEVM software.

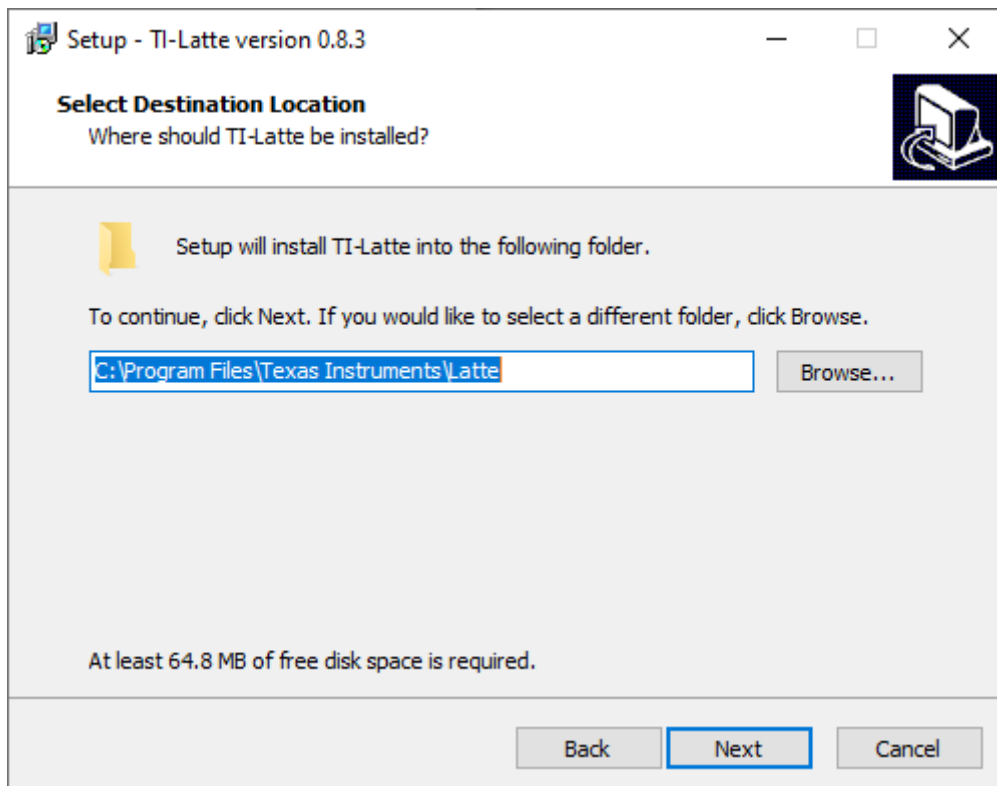

Figure 3-3. OPT4001YMNEVM Software-Installation Prompts

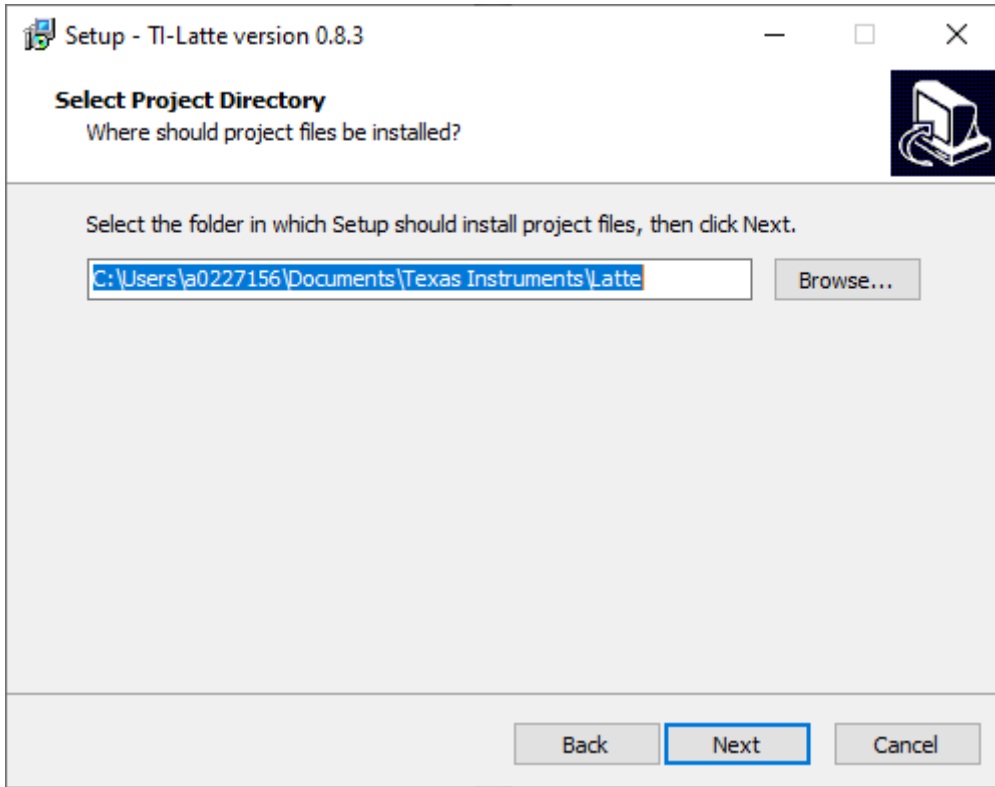

Figure 3-4. OPT4001YMNEVM Software-Installation Prompts

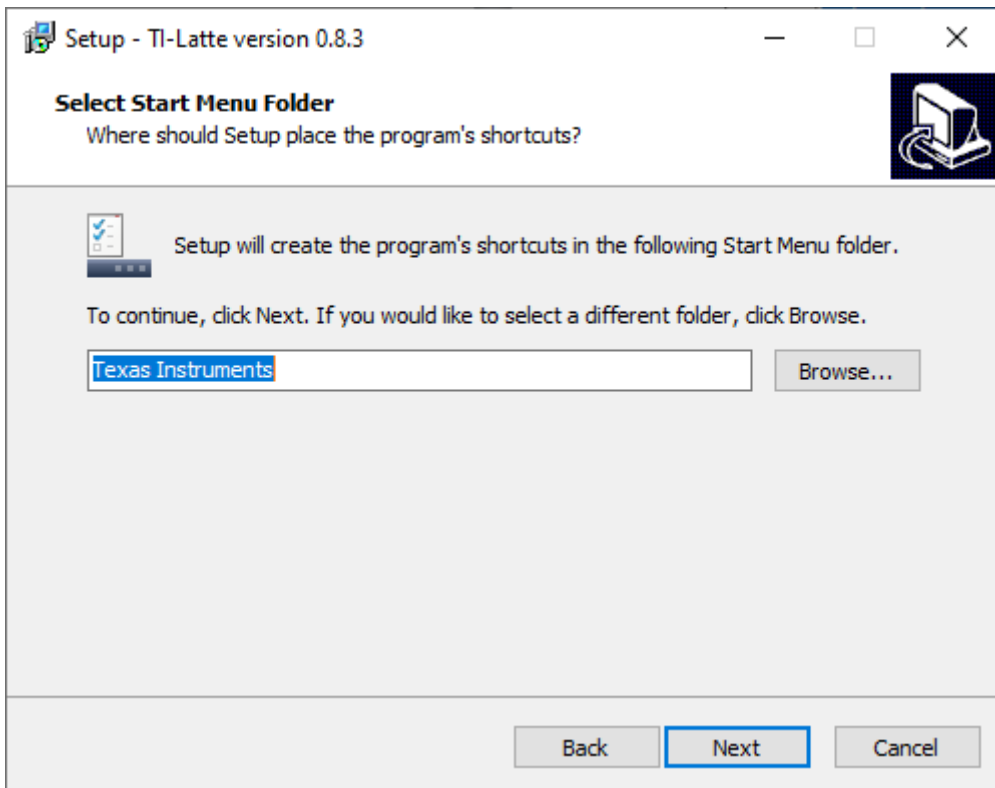

Figure 3-5. OPT4001YMNEVM Software-Installation Prompts

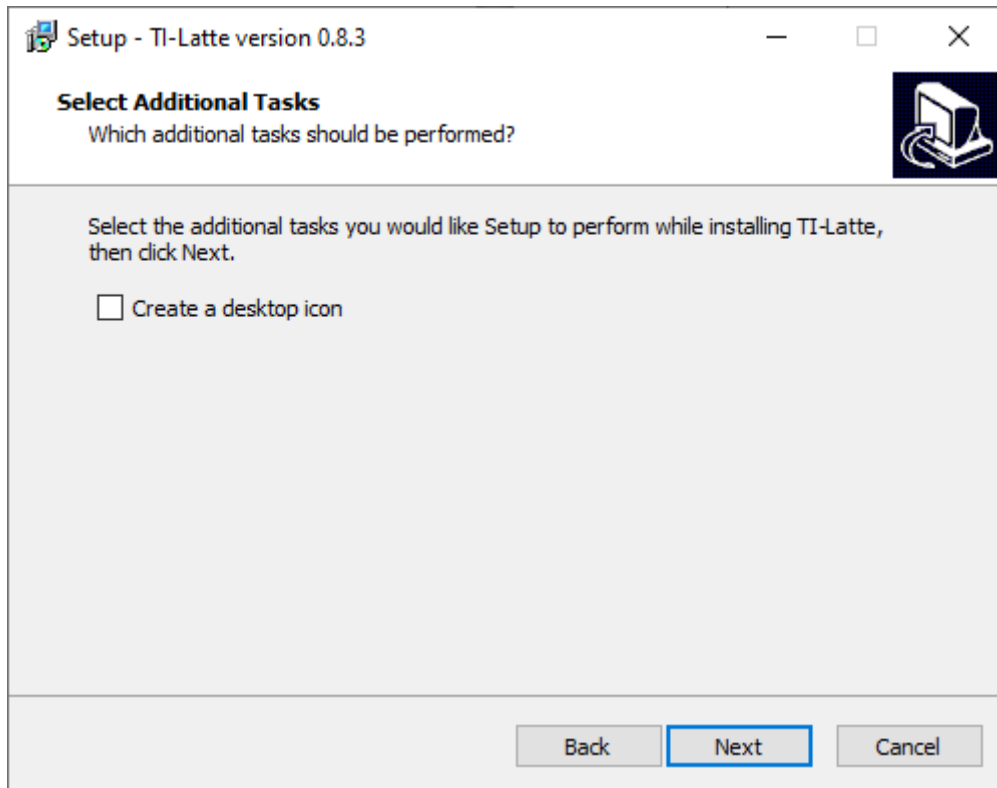

Figure 3-6. OPT4001YMNEVM Software-Installation Prompts

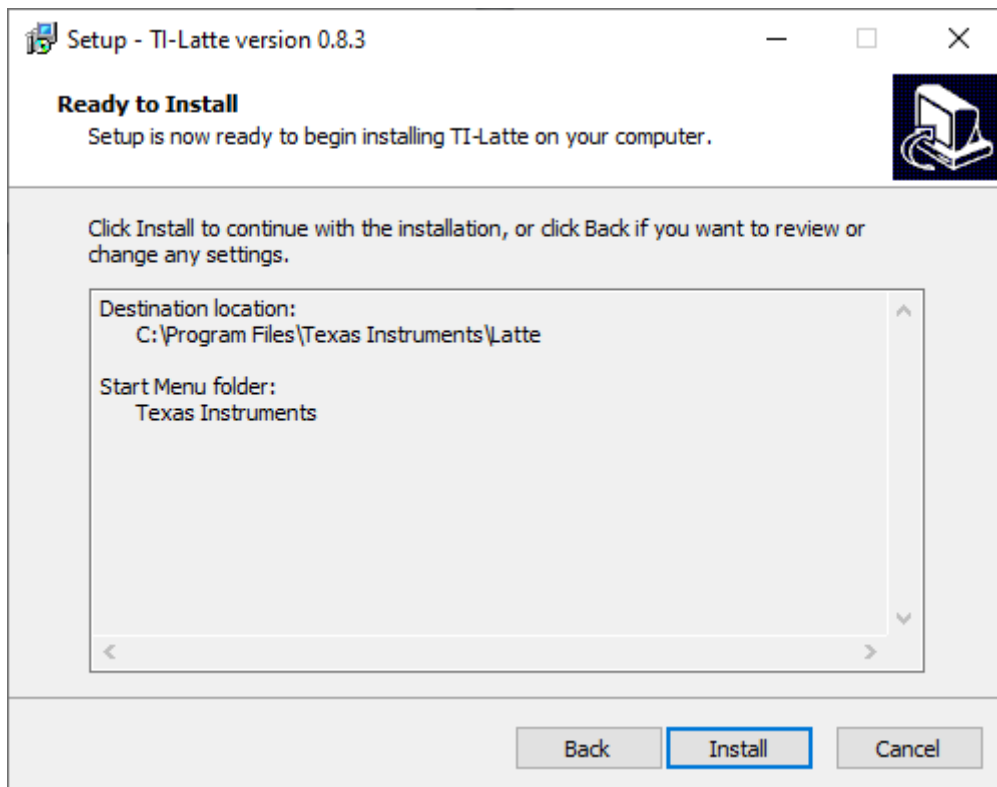

Figure 3-7. OPT4001YMNEVM Software-Installation Prompts

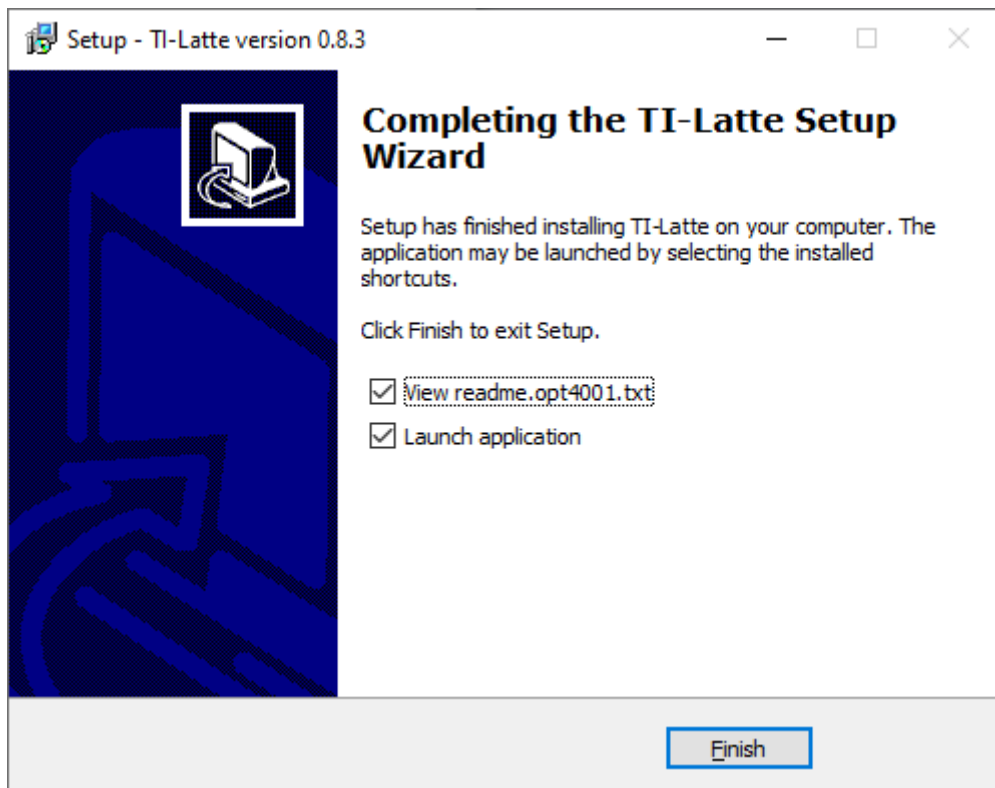

Figure 3-8. OPT4001YMNEVM Software-Installation Prompts

The OPT4001EVM GUI software is now installed.

3.3 Typical OPT4001YMNEVM Hardware Setup

Plug the male USB-C cable to the OPT4001EVM board and then plug the male USB-A cable into the computer. The green light will light up on the EVM as shown in [Figure 3-9](#).



Figure 3-9. Typical Hardware Connection

When the EVM is plugged into the USB port of the computer it will enumerate as two com ports. This will show up in the Windows device manager as show in [Figure 3-10](#).



Figure 3-10. Typical Response After Connecting OPT4001YMNEVM to the Computer

Connect the EVM via USB to the PC. If Windows shows a notification that a driver is not found for the device connected, see the instructions to manually install drivers in [Section 5.1](#) before proceeding.

3.4 Launching the OPT4001EVM Software

With the OPT4001YMNEVM properly connected, launch the Latte EVM GUI software from the Windows *Start* menu. The software launches with a screen similar to that shown in [Figure 3-11](#).

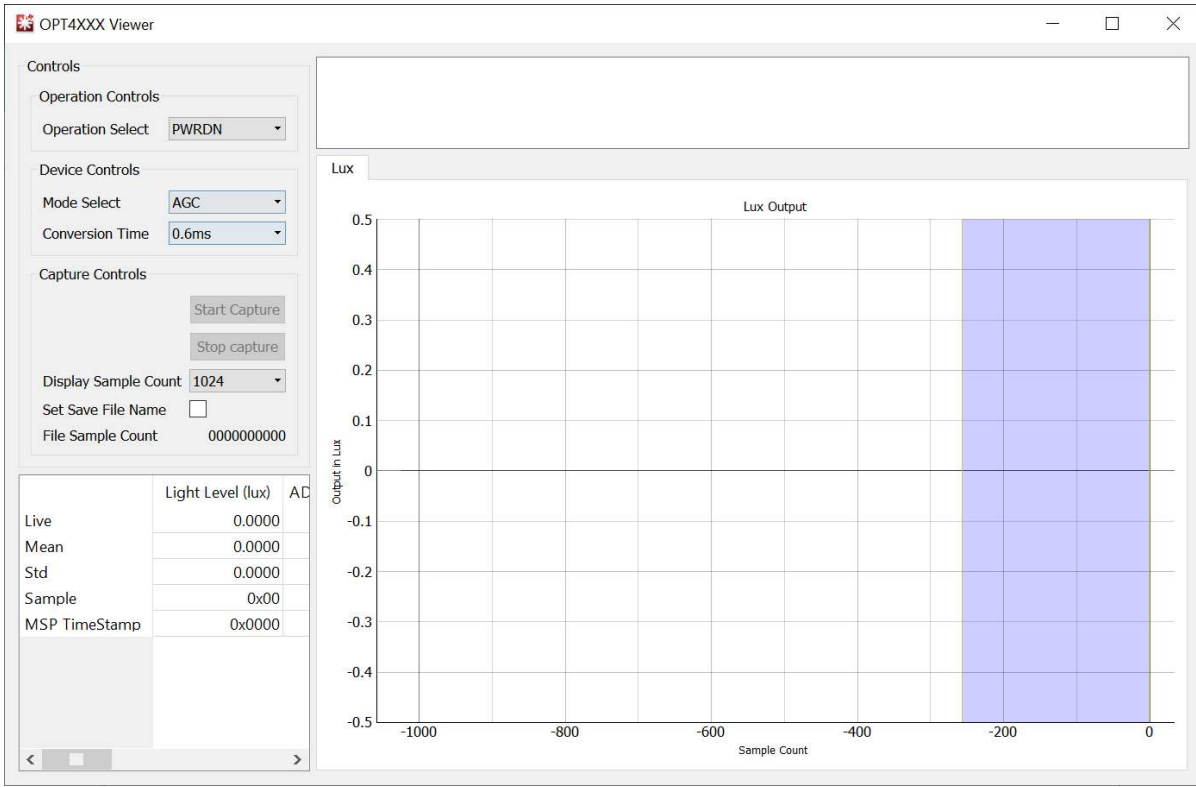

Figure 3-11. OPT4001 Main Operation Screen

If the message shown in [Figure 3-12](#) appears when the OPT4001EVM GUI software is launched, this means that the EVM motherboard was not detected. Check the USB connection and that the motherboard appears in the device manager as shown in [Section 3.3](#). A green light will appear on the motherboard if it is receiving power from the PC and the GUI "start capture" button has not been enabled.

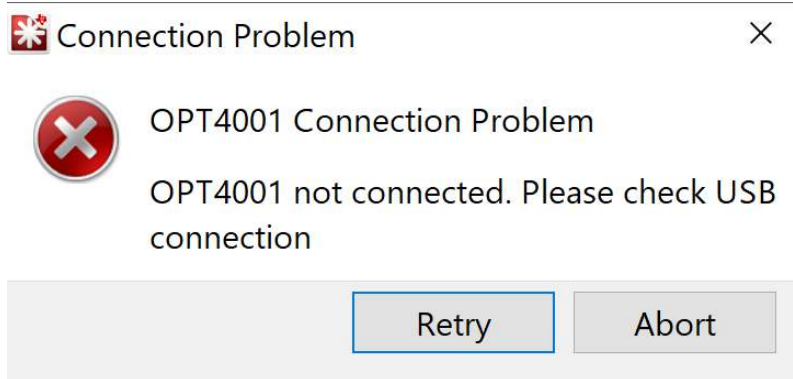

Figure 3-12. Hardware Error Message

3.5 OPT4001EVM Software Operation

This section primarily discusses how to operate the OPT4001EVM software. The GUI has a primary window that is used to configure and read from the OPT4001YMNEVM, along with two other windows that are used to access different features of the OPT4001YMNEVM. Basic GUI functionality and a description of the tabs are also presented in this section.

3.5.1 Getting Started

To quickly start using the device, click the *Operation Select* drop-down menu and select *Continuous* to bring the device out of power down mode. Then click *Start Capture* to begin data capture. The green LED on the motherboard will turn off. Lux data will appear above the lux plot as shown. The plot will also start to populate with the device lux readings.

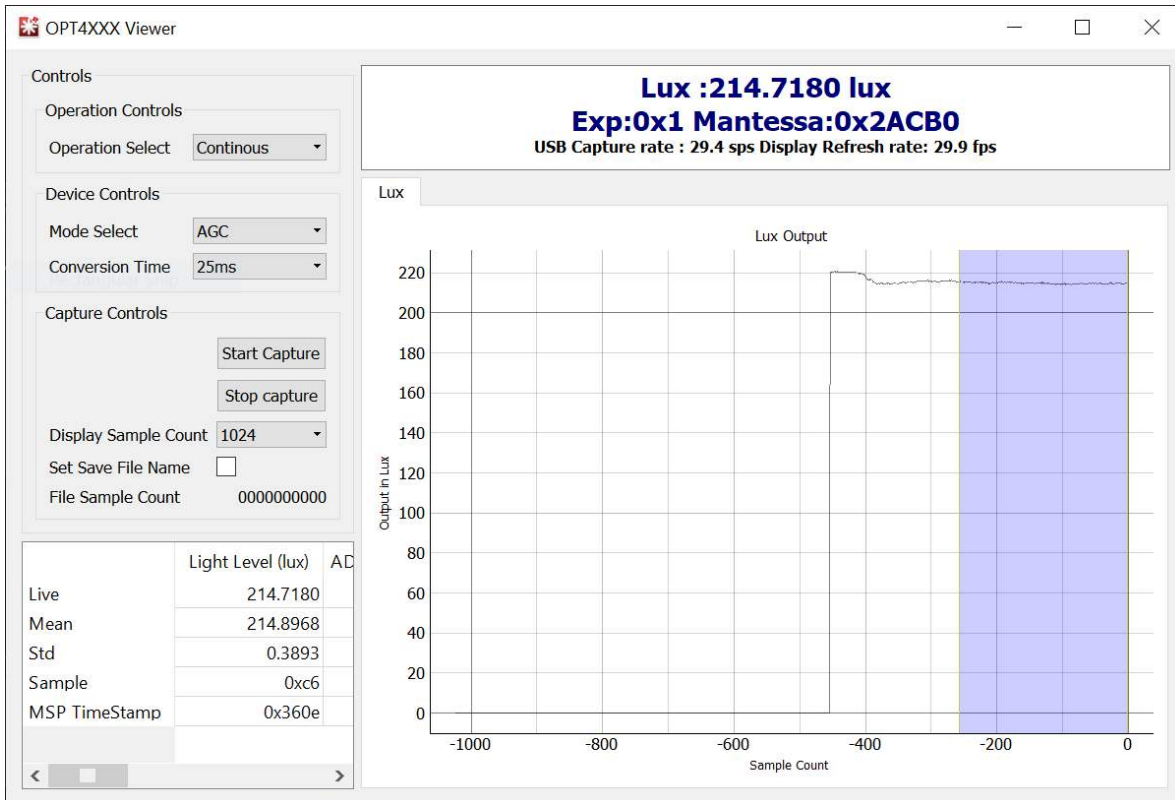

Figure 3-13. GUI Capture Running

If the GUI is not responsive, check the other Latte scripts window, which is minimized by default. If the message *Operation I2C Register Read for command [REGRx01] Failed* is displayed this means that the OPT4001 IC or coupon is not detected by the motherboard. Ensure the coupon is plugged in and properly oriented.

3.5.2 Feature Descriptions

Lux Plot

In the center of the GUI window you will see a plot showing the lux reading from the device on the y-axis and the sample number on the x-axis. The plot settings can be tweaked by right clicking on the plot. The x-axis and y-axis options under the right-click menu allow the range of x and y-axes displayed to be changed. There is also an auto option that will dynamically change the range to match the data. Scrolling will zoom in to or zoom out from the plot. Left-clicking and dragging will display a yellow rectangle that will, upon releasing the mouse, zoom the data to the rectangle drawn. Right-clicking and dragging up or down zooms the y-axis. Right-clicking and dragging right or left will zoom the x-axis. Right clicking and selecting *View All* will reset the view.

Drop-down Menus

At the top left of the plot are two drop-down menus.

The *operation select* drop-down menu allows device operating mode to be switched between power down and continuous capture modes. The one shot mode of the device is not exposed by the EVM GUI.

The *mode select* drop-down menu changes the device gain range setting mode. The device supports automatic gain control (ACG), which is the recommended mode setting for most use cases, or the gain range of the device can be selected manually using this drop-down menu.

The device supports twelve *conversion times* from 0.6 ms to 800 ms, which can be selected using the respective drop-down menu.

The *display sample count* selects how many samples are displayed on the x-axis of the plot.

Save to file

The *set save to file name* check box allows the data captured in the GUI to be dumped to a CSV file. Clicking this check box will display a windows file selector screen. Select the directory to store the CSV and set the name for the CSV. After clicking save the GUI will wait for you to click the *start capture* button to start saving data and subsequently it will wait for a click on the *stop capture* button to copy all the data into the indicated CSV file. When capturing data with save enabled, the GUI will initially dump the data to temporary .npy files. After clicking *stop capture* this data is written over to the CSV file and .npy files are removed.

Mean, Std, and the Blue Slider

There is a blue slider on the lux plot shown on the right side of the plot in the figure. Mean and Std columns in the table where capture data is displayed are calculated from only the data within the blue slider. Left-clicking on the middle of this slider and dragging moves the slider. Left-clicking on the edge of either side of the slider and dragging will adjust the size of the slider. This allows the mean and standard deviation of the distance, phase, and amplitude to be computed for any continuous portion of the displayed data. If capture is running, this data updates in real-time along with the data in the Live column.

Scripts Window

When Latte is launched, the GUI window appears front and center. However, there is a second window that is minimized at launch. This is the scripts window and it exposes some more advanced features of the Latte platform as shown in [Figure 3-14](#).

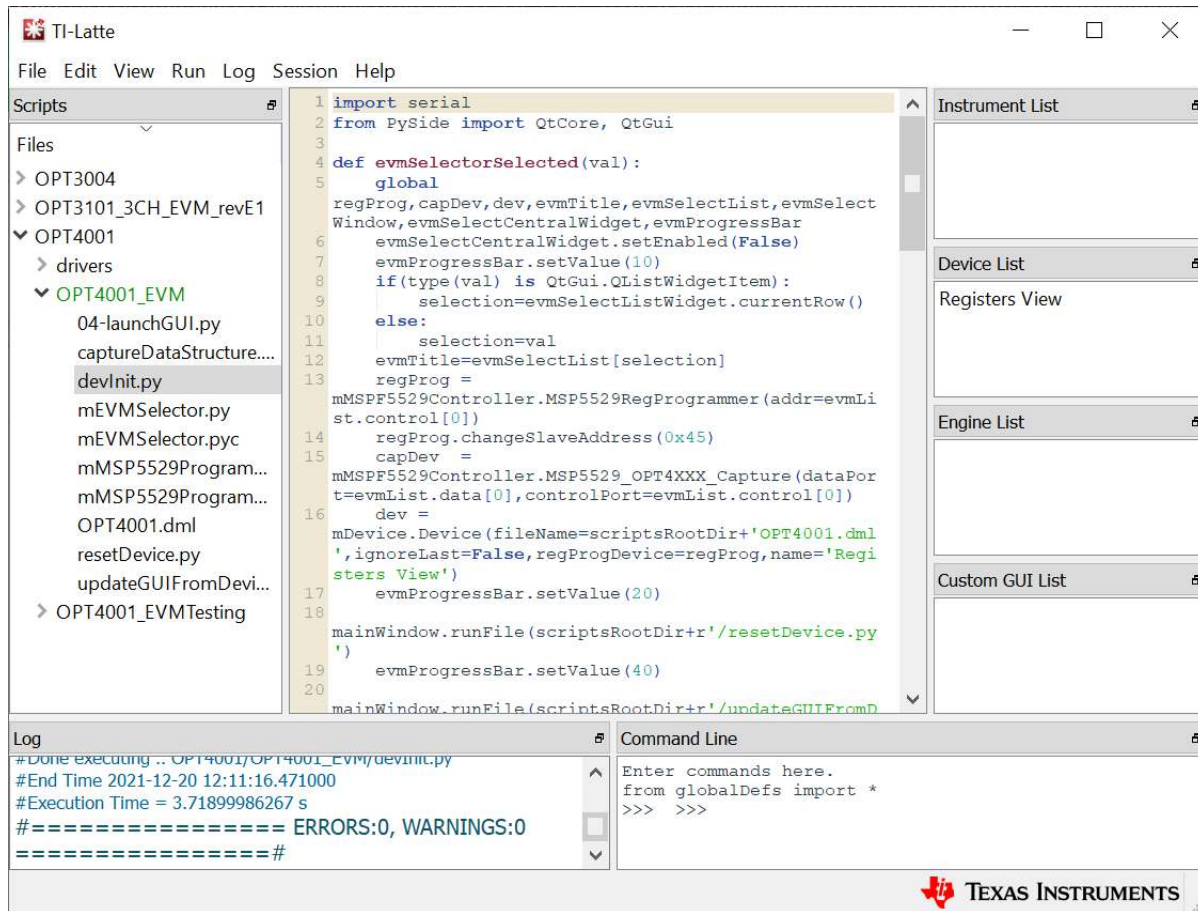

Figure 3-14. Latte Scripts Window

The scripts window also provides access to the device registers view that displays the stored value of the device registers and allows them to be changed directly. Launch the registers view by double clicking on the *Registers View* button under the *Device List* box on the right side of the screen.

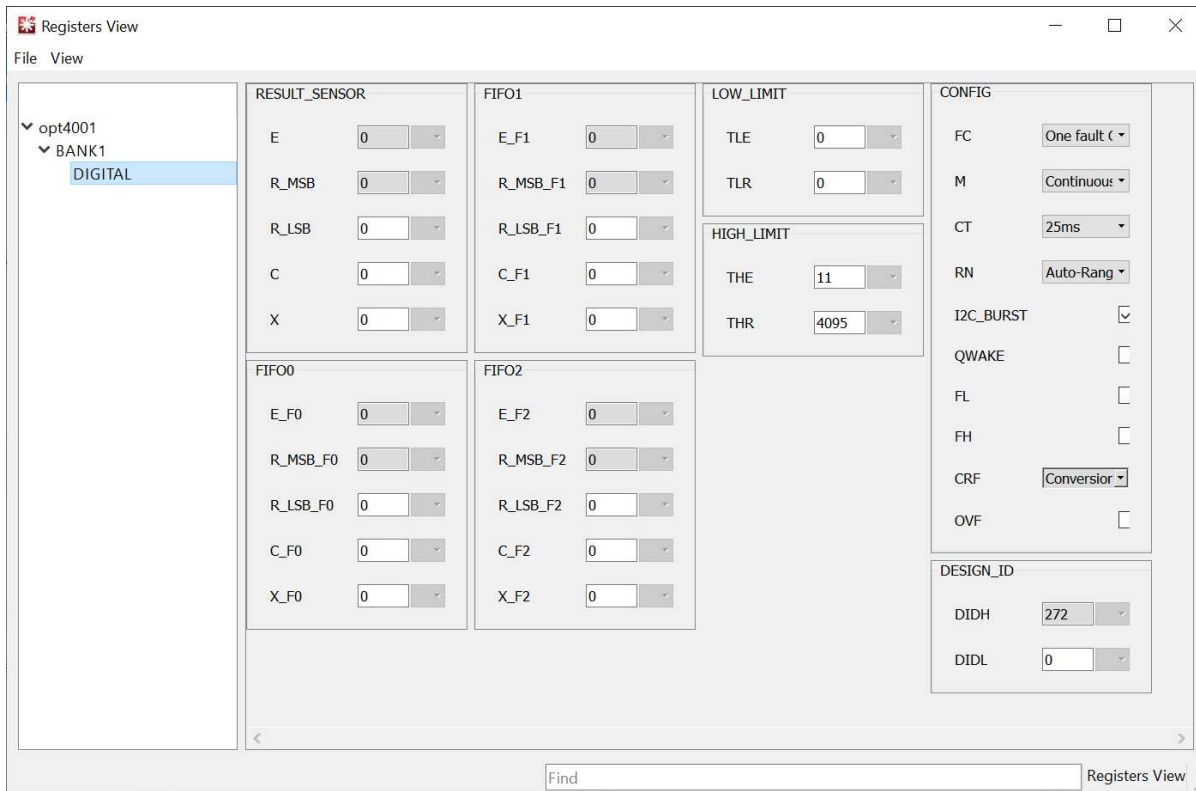

Figure 3-15. Registers View

Overview of Device Registers

Registers x00 and 0x01 are the result registers and provide the output data from the device as an exponent and mantissa value indicated as e and r in the register view. The mantissa is split between registers 0x00 and 0x01 as R_MSB and R_LSB. A sample counter (C) and CRC check bits (X) are also contained in register 0x01.

Registers 0x0A, 0x0B, and 0x0C are the configuration registers and provide feedback about the state of the device; the bit names and full descriptions are shown in the [OPT4001 data sheet](#). Each of the read-only status bits are greyed out and cannot be changed.

Registers x08 and x09 allow low and high limits, respectively, to be set. These registers are used in certain interrupt reporting modes.

The device ID is contained in register 0x11.

Additional Features of the Scripts Window

Hidden IDE Window

The Latte program runs a number of Python scripts in the background to capture and display data from the EVM. These scripts allow for initialization of the device including loading calibration data from the EVM flash memory, launching a live view window with measurement plot and readings, and additional functionality such as reading from the flash and selecting a specific LED current for the device to use. For advanced users or users looking for more flexibility when using the OPT3101EVM, these Python scripts are available in an integrated development environment (IDE) window that is minimized when TI-Latte is launched. The IDE window can be used to customize the existing scripts or write new scripts.

After launching Latte, expand the OPT4001YMN directory on the left side of the window under Files by clicking the triangle to the left of the directory name. This displays the OPT4001YMNEVM folder. Further expanding the OPT4001YMNEVM folder will display all the example scripts as shown in [Figure 3-14](#).

devInit.py

Open the devInit.py script by clicking on the corresponding file in the OPT4001YMNEVM folder on the left side of the screen. This displays the contents of the script on the center of the window. With devInit.py still selected in TI-Latte, click Run>Buffer from the top menu bar of TI-Latte (or press F5) to run the script. Once completed, the live-view GUI is opened in a new window. More details on the live-view GUI are given in the following section. Additional info is also displayed in the log window in the lower left corner of the main window.

04-launchGUI.py

A live-view GUI window is launched when running the devInit.py script. This allows data from the OPT4001 to be viewed on a graph in real-time. The GUI is created in the launchGUI.py example script. When running devInit.py, the launchGUI.py script is automatically ran. However, if the GUI window is closed it can be re-launched by directly running the launchGUI.py script. To do this, select the launchGUI.py script and click Run>Buffer or press F5. [Figure 3-13](#) shows the live GUI plot.

4 Schematic, PCB Layout, and Bill of Materials

This EVM consists of 3 boards as shown in [Figure 4-1](#). The flex coupon board is a flex PCB with OPT4001 IC and cutout for optimal sensor field of view. This flex board is soldered onto a rigid coupon board for added stability. The rigid coupon board contains 8 pins which allow it to plug into a socket on the motherboard. The motherboard contains an MSP430 microcontroller and plugs into a PC through the provided USB cable. This section contains the schematics, layout, and bill of materials for these 3 boards.

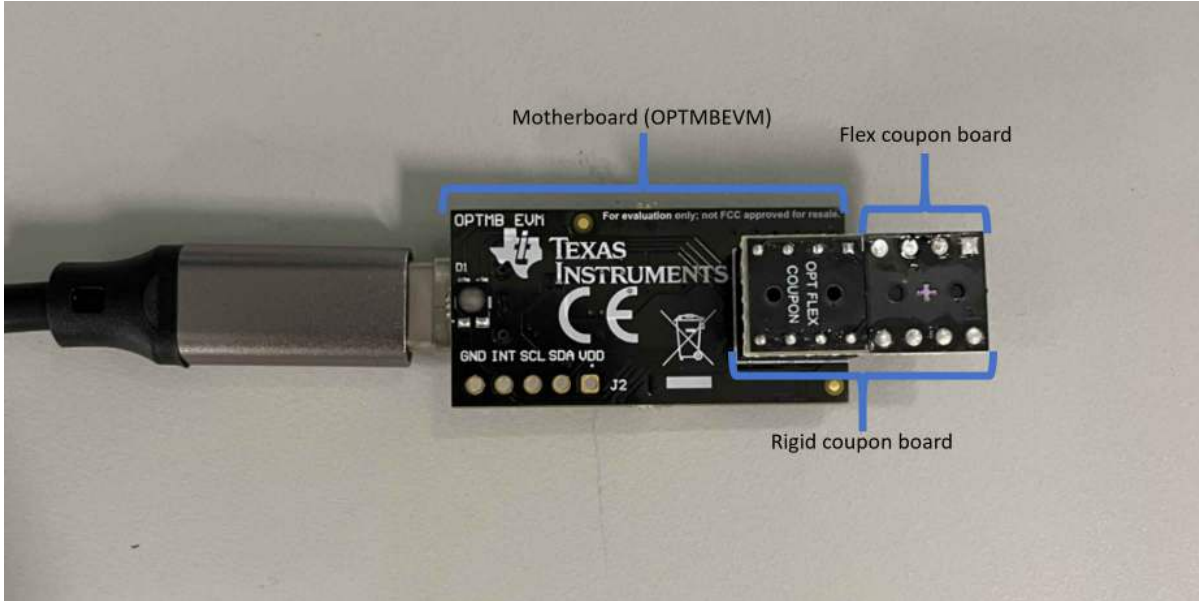

Figure 4-1. OPT4001YMNEVM construction

4.1 Flex Coupon Board

4.1.1 Schematic

[Figure 4-2](#) shows the schematic of the OPT4001YMN flex coupon board.

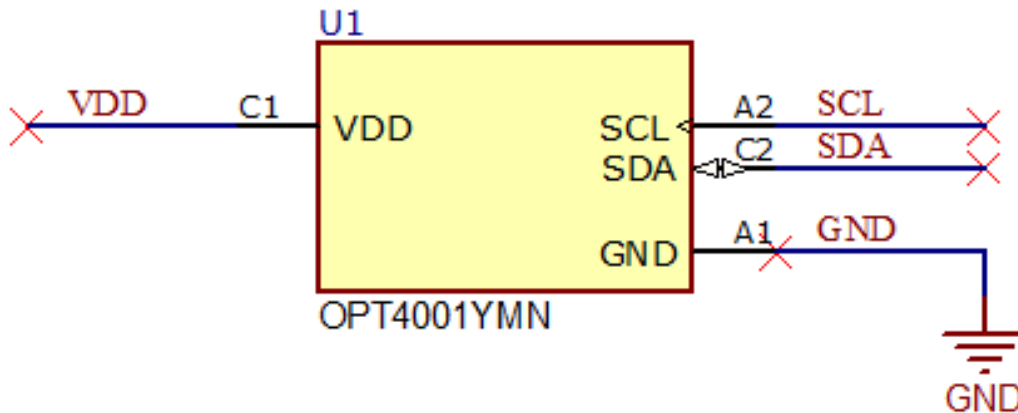

Figure 4-2. OPT4001 Flex Coupon Board Schematic

4.1.2 PCB Layout

Figure 4-3 and Figure 4-4 show the top and bottom PCB layers, respectively, of the flex coupon board. Figure 4-5 and Figure 4-6 show the assembly drawings of the top and bottom PCB layers, respectively.

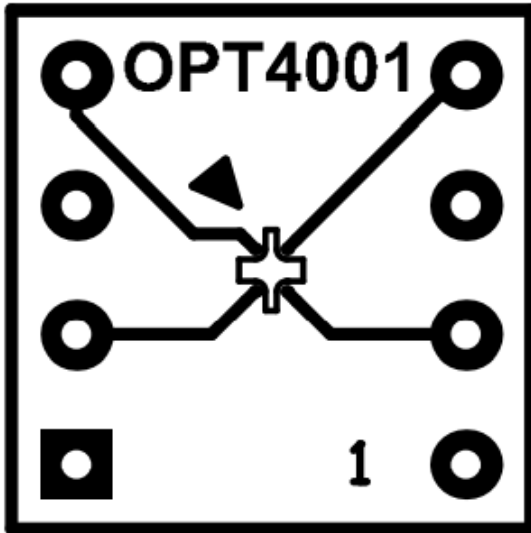

Figure 4-3. PCB Top Layer

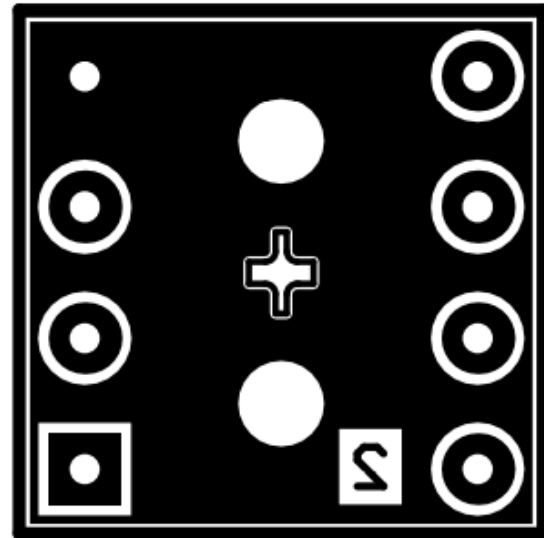

Figure 4-4. PCB Bottom Layer

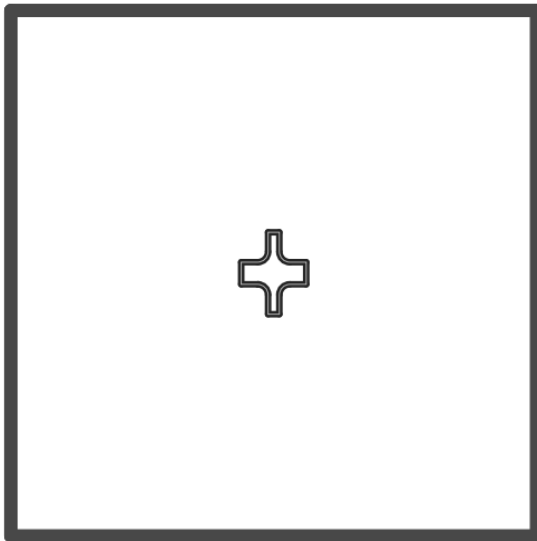

Figure 4-5. PCB Top-Layer Assembly Drawing

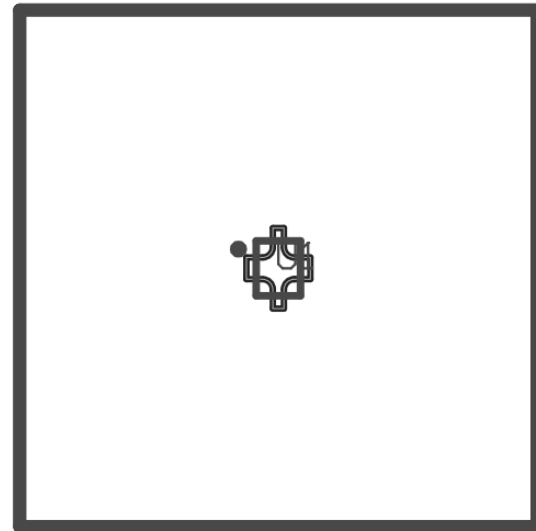

Figure 4-6. PCB Bottom-Layer Assembly Drawing

4.1.3 Bill of Materials

Table 4-1 lists the bill of materials for the OPT4001YMN coupon board.

Table 4-1. OPT4001YMN Flex Coupon Board Bill of Materials

Designator	Quantity	Description	Part Number	Manufacturer
U1	1	Ambient Light Sensor (ALS) With Excellent AngularIR Rejection	OPT3004DTS	Texas Instruments

4.2 Rigid Coupon Board

4.2.1 Schematic

Figure 4-7 shows the schematic of the OPT4001YMN coupon rigid board. C1 is a bypass capacitor for device VDD.

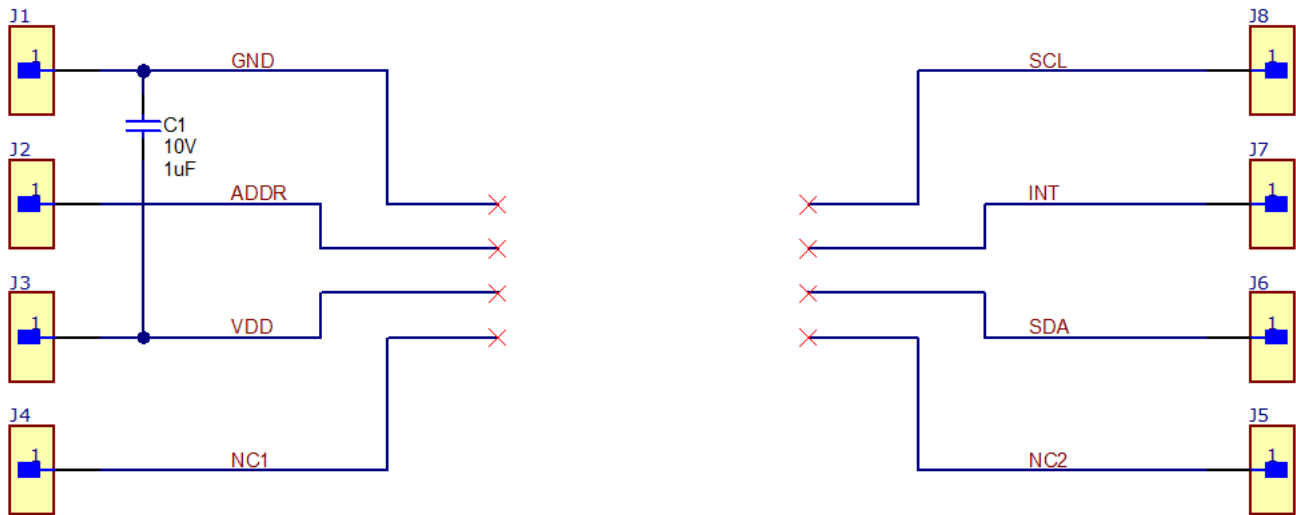

Figure 4-7. OPT4001 Coupon Rigid Board Schematic

4.2.2 PCB Layout

Figure 4-8 and Figure 4-9 show the top and bottom PCB layers, respectively, of the coupon rigid board. Figure 4-10 and Figure 4-11 show the assembly drawings of the top and bottom PCB layers, respectively.

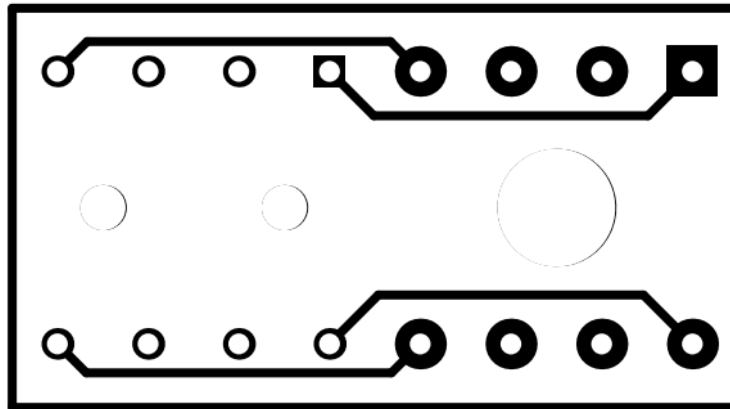

Figure 4-8. PCB Top Layer

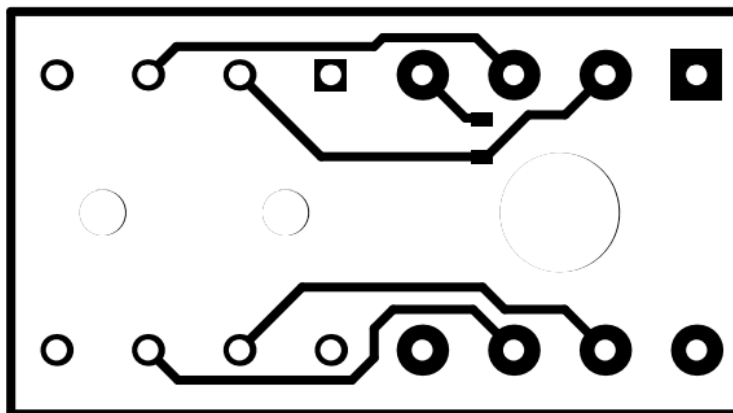

Figure 4-9. PCB Bottom Layer

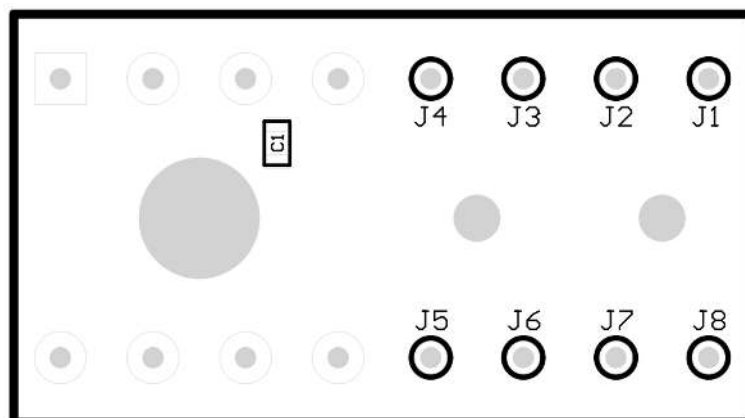

Figure 4-10. PCB Top-Layer Assembly Drawing

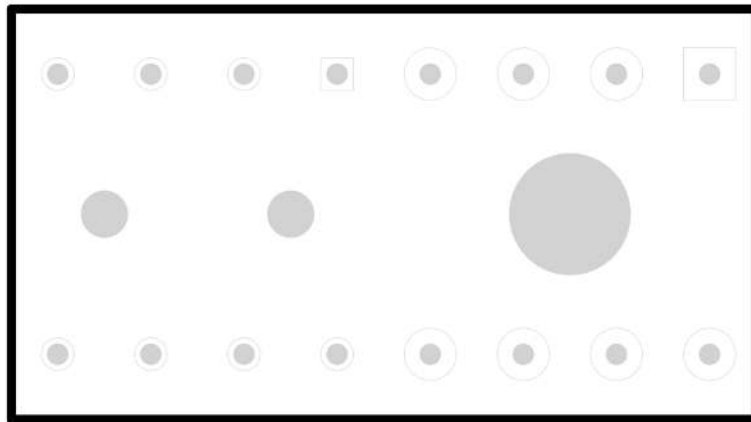

Figure 4-11. PCB Bottom-Layer Assembly Drawing

4.2.3 Bill of Materials

Table 4-2 lists the bill of materials for the OPT4001YMN coupon board.

Table 4-2. OPT4001YMN Rigid Coupon Board Bill of Materials

Designator	Quantity	Description	Part Number	Manufacturer
C1	1	CAP, CERM, 1 uF, 10 V, +/- 10%, X7S, AEC-Q200 Grade 1, 0402	GCM155C71A105KE38D	MuRata
J1, J2, J3, J4, J5, J6, J7, J8	8	PC Pin Terminal Connector Through Hole Gold 0.017" (0.43mm) Dia	3121-2-00-15-00-00-08-0	Mill-Max

4.3 Motherboard

4.3.1 Schematic

Figure 4-12 shows the complete schematic of the OPTMBEVM motherboard. The schematic is split into three sections: connector, MSP430, and socket. A USB type C connector is used to interface with the PC. The MSP430 microcontroller allows the PC to interface with the OPT3004DTS through I2C. The coupon board containing the OPT4001 plugs into the motherboard through the socket. The OPTMBEVM board provides easy access to the I2C, INT, VDD, and GND lines. The header J2 is depopulated on the EVM by default and its labeled through hole pads can be used to access the lines. Alternatively, a header can be populated at J2 for easier access.

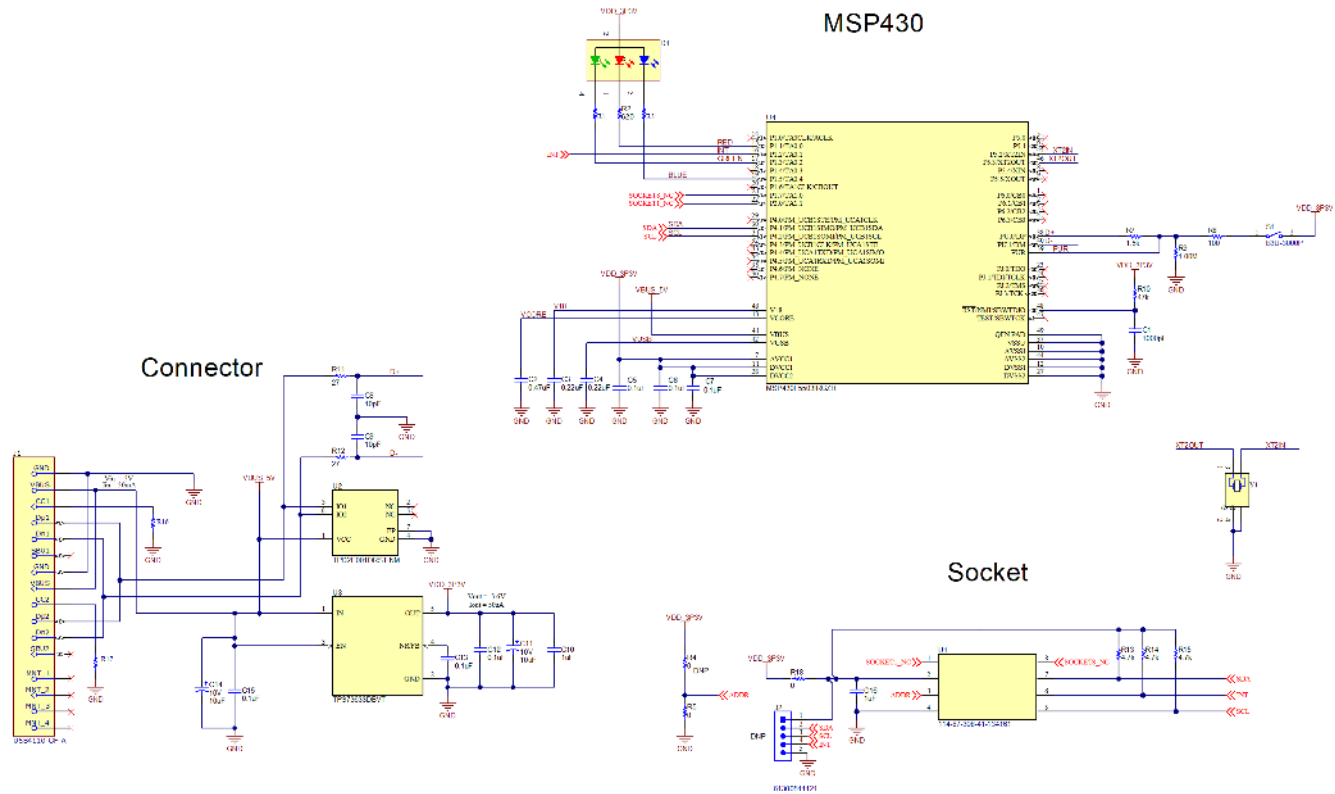

Figure 4-12. OPTMBEVM Schematic

4.3.2 PCB Layout

Figure 4-13 and Figure 4-14 show the top and bottom PCB layers, respectively, of the test board. Figure 4-15 and Figure 4-16 show the assembly drawings of the top and bottom PCB layers, respectively.

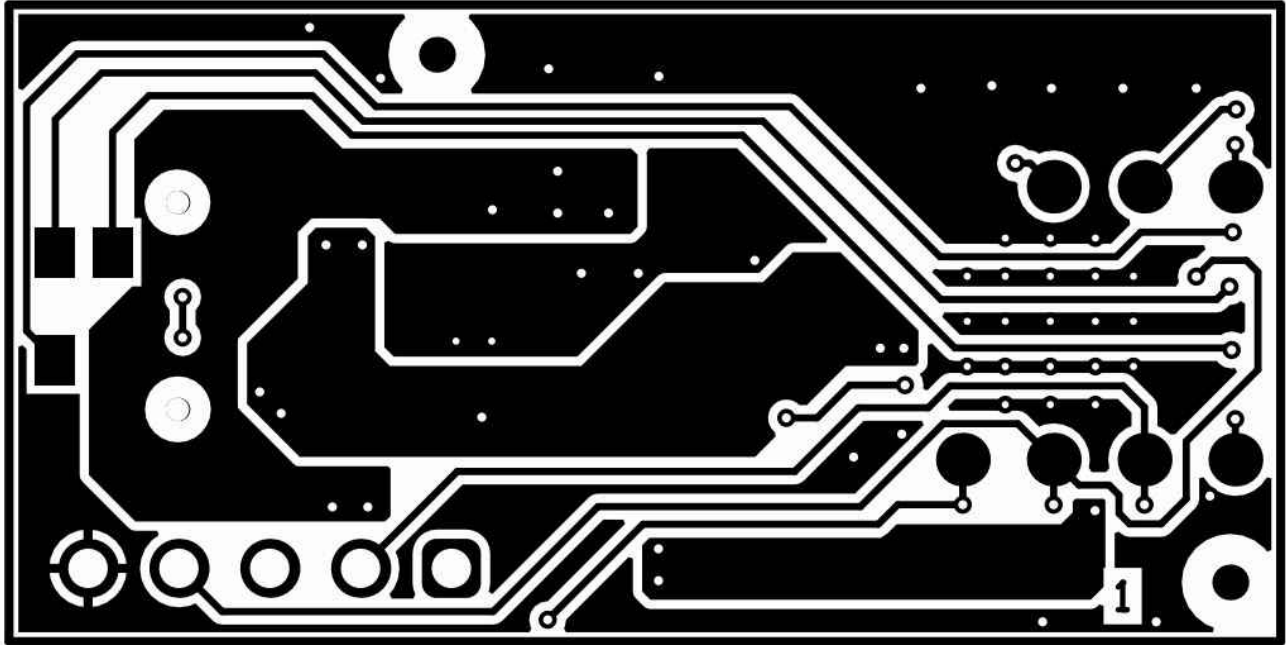

Figure 4-13. PCB Top Layer

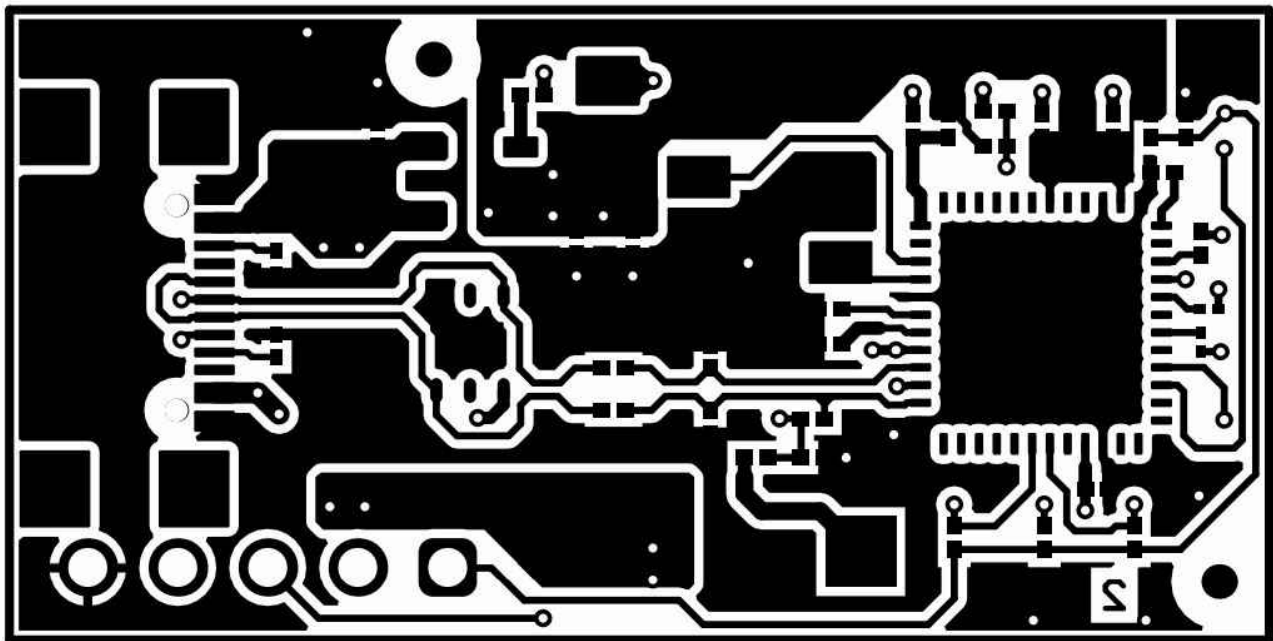

Figure 4-14. PCB Bottom Layer

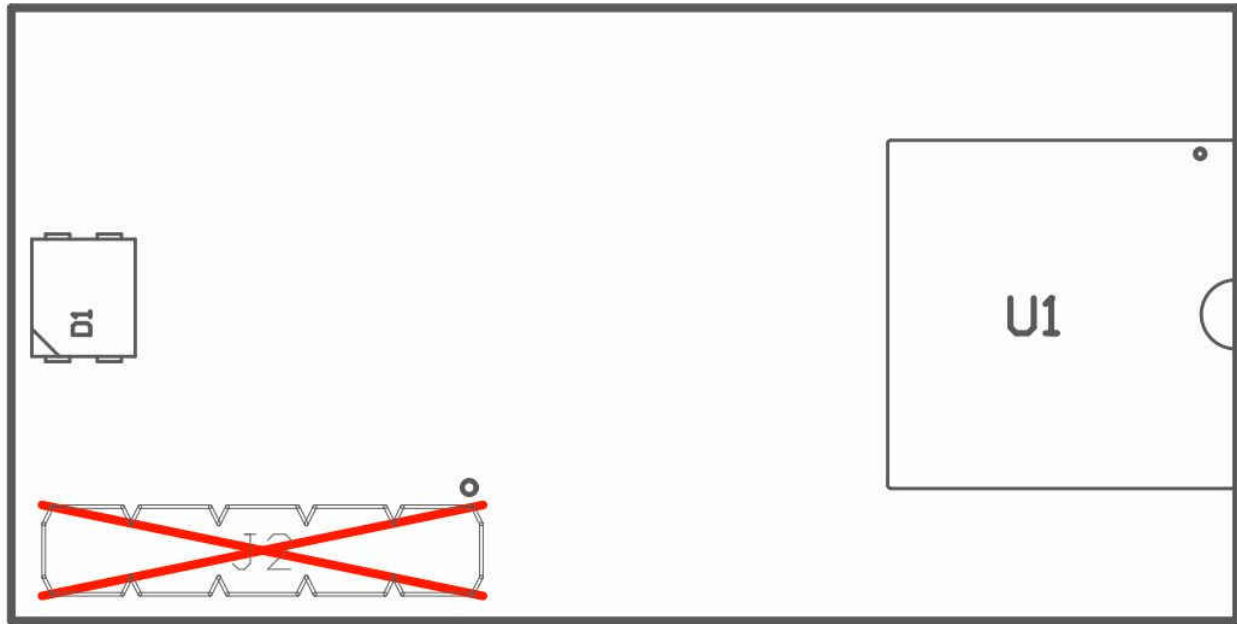

Figure 4-15. PCB Top-Layer Assembly Drawing

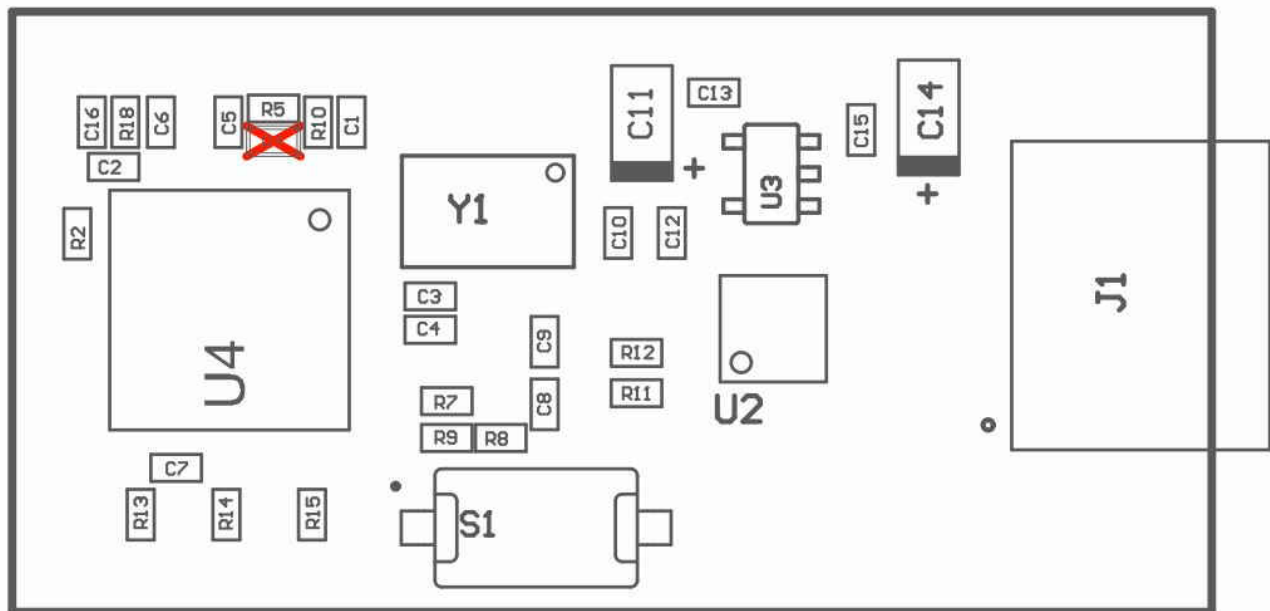

Figure 4-16. PCB Bottom-Layer Assembly Drawing

4.3.3 Bill of Materials

Table 4-3 lists the bill of materials for the OPTMBEVM motherboard.

Table 4-3. OPTMBEVM Bill of Materials

Designator	Quantity	Description	Part Number	Manufacturer
C1	1	CAP, CERM, 1 uF, 10 V, +/- 10%, X7S, AEC-Q200 Grade 1, 0402	GCM155C71A105KE38D	MuRata
J1, J2, J3, J4, J5, J6, J7, J8	8	PC Pin Terminal Connector Through Hole Gold 0.017" (0.43mm) Dia	3121-2-00-15-00-00-08-0	Mill-Max
R2	1	RES, 620, 5%, 0.05 W, 0201	RC0201JR-07620RL	Yageo America
R5, R18	2	RES, 0, 5%, .05 W, AEC-Q200 Grade 0, 0201	ERJ-1GN0R00C	Panasonic
R7	1	RES, 1.5 k, 5%, 0.05 W, 0201	RC0201JR-071K5L	Yageo America
R8	1	RES, 100, 1%, 0.05 W, 0201	ERJ-1GEF1000C	Panasonic
R9	1	RES, 1.00 M, 1%, 0.05 W, AEC-Q200 Grade 0, 0201	RK73H1HTTC1004F	KOA Speer
R10	1	RES, 47 k, 5%, 0.05 W, 0201	RC0201JR-0747KL	Yageo America
R11, R12	2	RES, 27, 5%, 0.05 W, 0201	RC0201JR-0727RL	Yageo America
R13, R14, R15	3	RES, 4.7 k, 5%, 0.05 W, 0201	RC0201JR-074K7L	Yageo America
R16, R17	2	RES SMD 5.1K OHM 5% 1/20W 0201	CRCW02015K10JNED	Vishay Dale
S1	1	Switch, Tactile, SPST-NO, 0.05A, 12V, SMD	RS-032G05A3-SM RT	C&K Components
U1	1	Socket, DIP-8, 2.54 mm Pitch, SMT	114-87-308-41-134161	Preci-Dip
U2	1	Low-Capacitance + / - 15 kV ESD-Protection Array for High-Speed Data Interfaces, 2 Channels, -40 to +85 degC, 6-pin SON (DRS), Green (RoHS & no Sb/Br)	TPD2E001DRST-NM	Texas Instruments
U3	1	Single Output Low Noise LDO, 400 mA, Fixed 3.3 V Output, 1.7 to 5.5 V Input, with Reverse Current Protection, 5-pin SOT-23 (DBV), -40 to 85 degC, Green (RoHS & no Sb/Br)	TPS73633DBVT	Texas Instruments
U4	1	Mixed Signal Microcontroller, RGZ0048A (VQFN-48)	MSP430F5503IRGZR	Texas Instruments
Y1	1	Crystal, 24 MHz, 10 pF, SMD	ABM3B-24.000MHZ-10-1-U-T	Abracon Corporation
FID1, FID2, FID3, FID4	0	Fiducial mark. There is nothing to buy or mount.	N/A	N/A
J2	0	Header, 2.54mm, 5x1, Gold, TH	61300511121	Würth Elektronik
R4	0	RES, 0, 5%, .05 W, AEC-Q200 Grade 0, 0201	ERJ-1GN0R00C	Panasonic

5 Troubleshooting

5.1 Microsoft Windows 7 Manual Driver Installation

This section outlines the manual driver installation process. If you are using Windows 7 or if the Windows device manager shows 2 USB Serial Devices under *other devices* as shown in [Figure 5-1](#) when the EVM is plugged in instead of COM ports, please use the following steps to correctly install the USB drivers. If two *USB Serial Device* devices show up as COM ports automatically (as is the case with Windows 10), then this section can be skipped.



Figure 5-1. OPT4001YMNEVM on Microsoft® Windows® 7 With Drivers not Installed

1. Open the device manager.

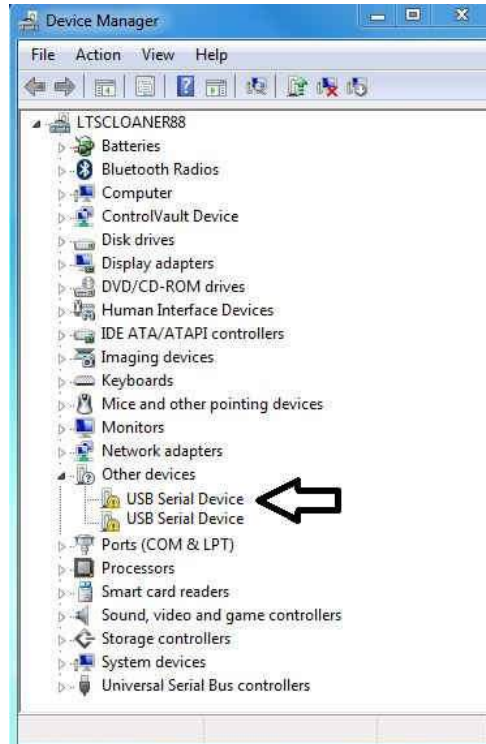

2. Right click on *USB Serial Device* and select Properties.

3. Click the **Update Driver...** button.



4. Click *Browse my computer for driver software*

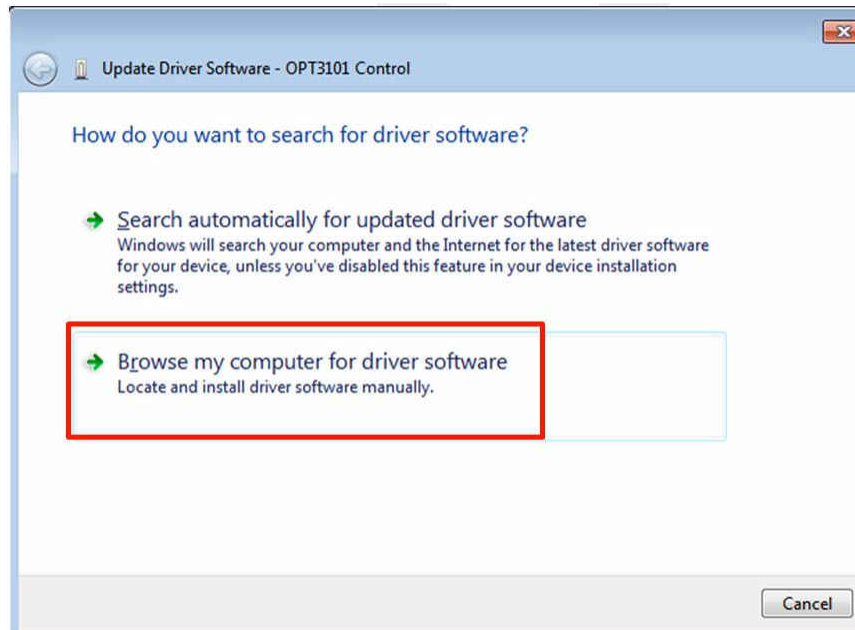

5. Click *Let me pick from a list of device drivers on my computer*.

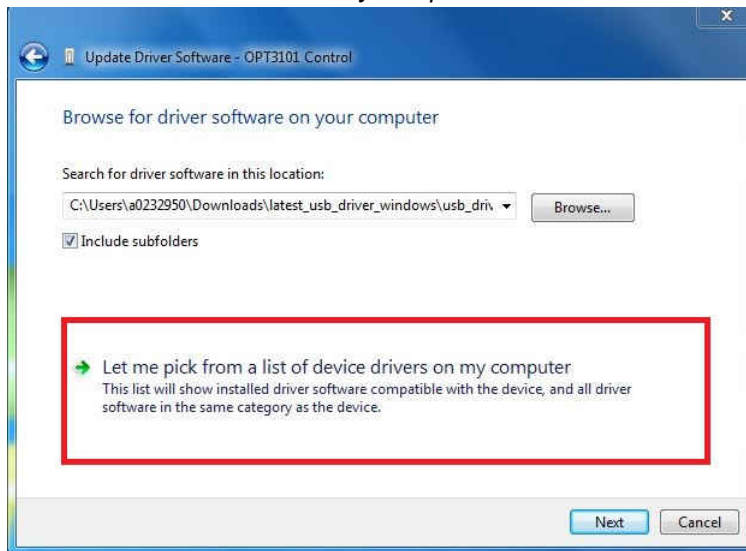

6. Select *Show All Devices* and click the **Next** button.

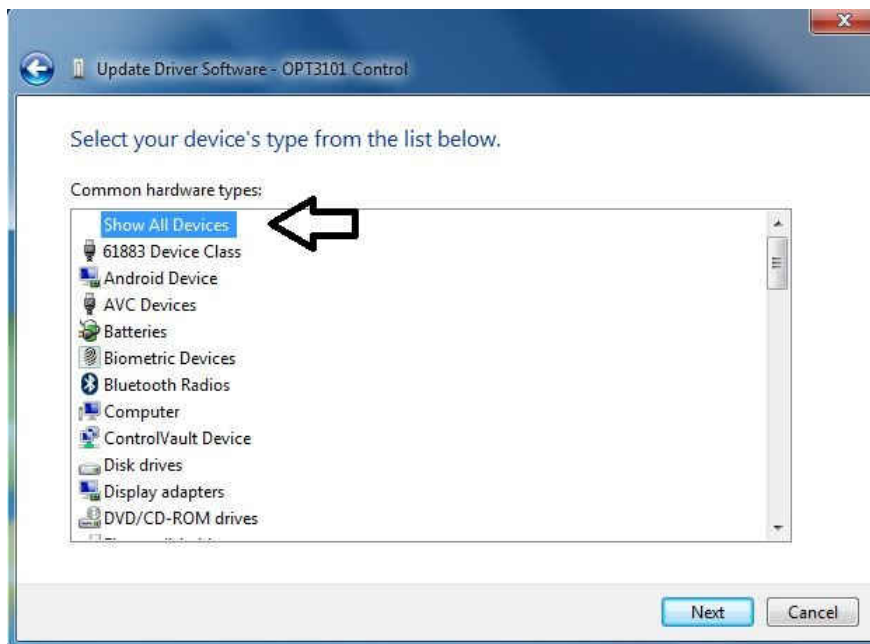

7. Click the **Have Disk...** button.

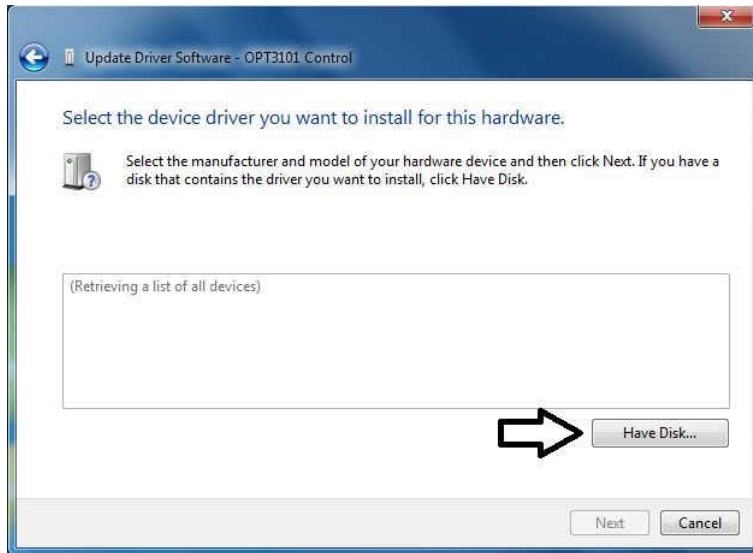

8. Click the **Browse...** button.

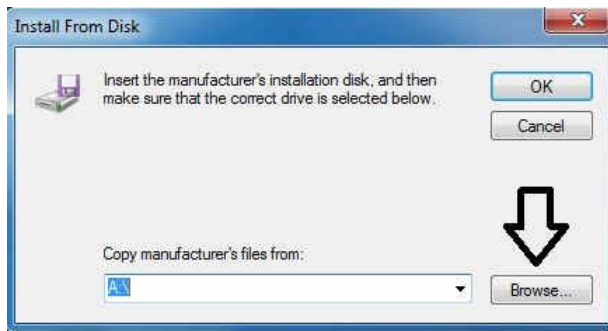

9. Navigate to "C:\Users\\Documents\Texas Instruments\Latte\projects\OPT4001\drivers" and choose MSP430_CDC. Click the **Open** button.

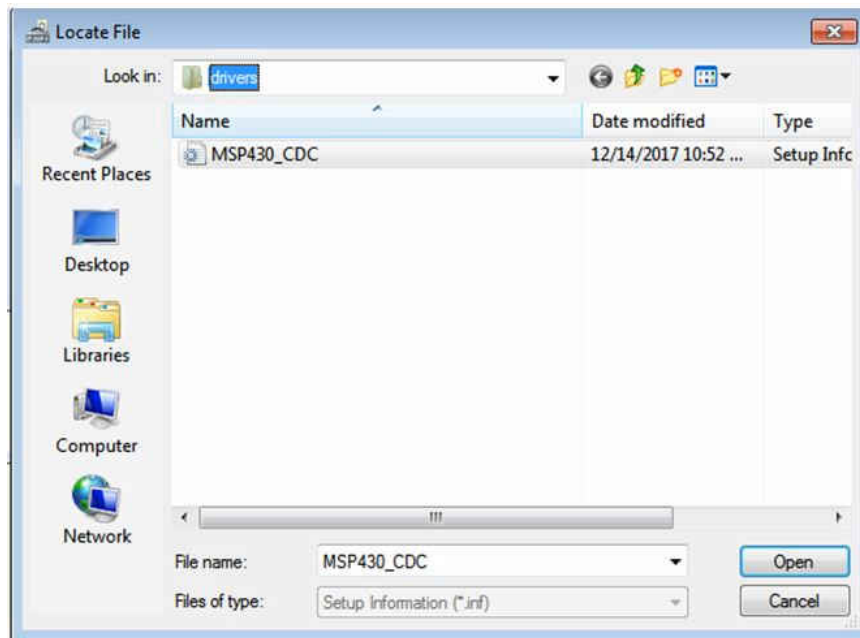

10. Click the **OK** button



11. Select the first *USB serial device* and click the **Next** button.

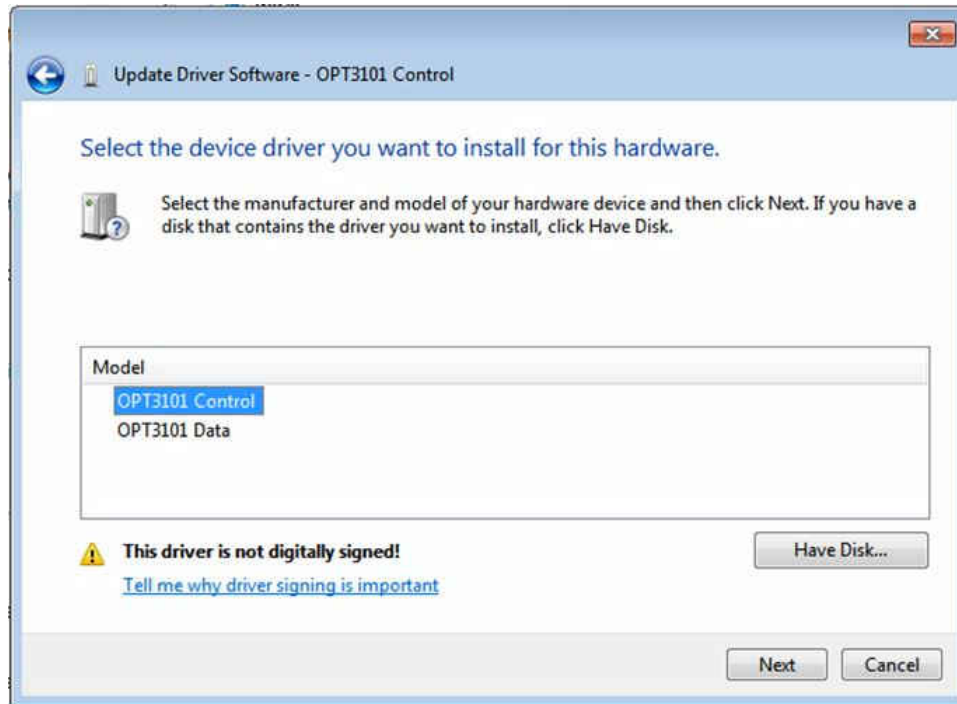

12. Click the **Yes** button.



13. The driver should now install properly.

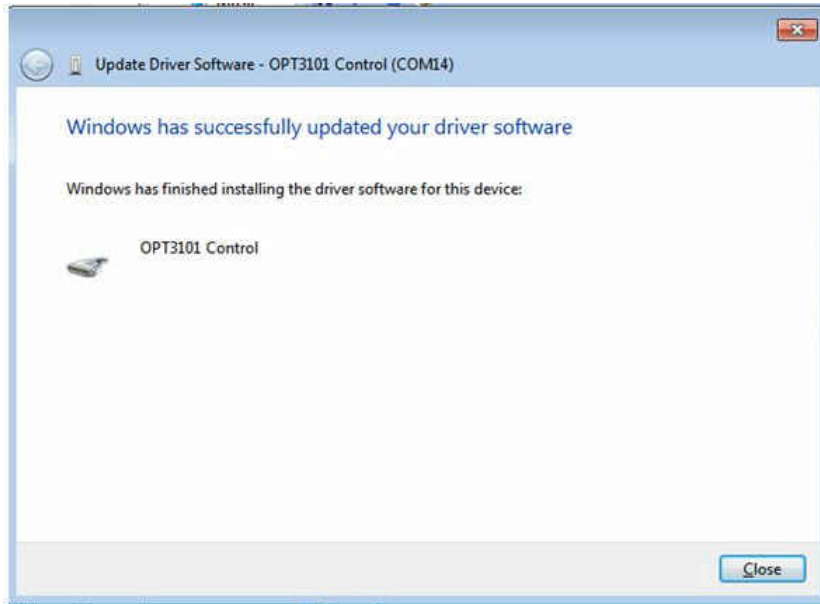

14. Now repeat this process (steps 1 to 13) for the second *USB Serial Device*. All steps are the same except for step 2 and step 11. In step 2 make sure to right click the second *USB Serial Device*. Likewise, on step 11 make sure to select the second *USB Serial Device* when installing the driver as the following figure shows.

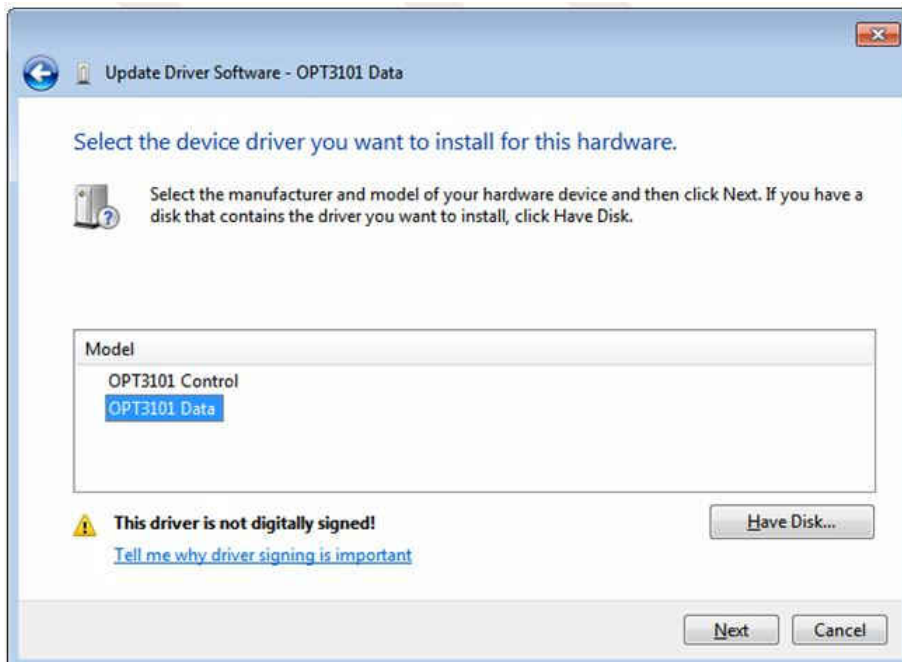

15. When the driver is installed, you will see the following message.

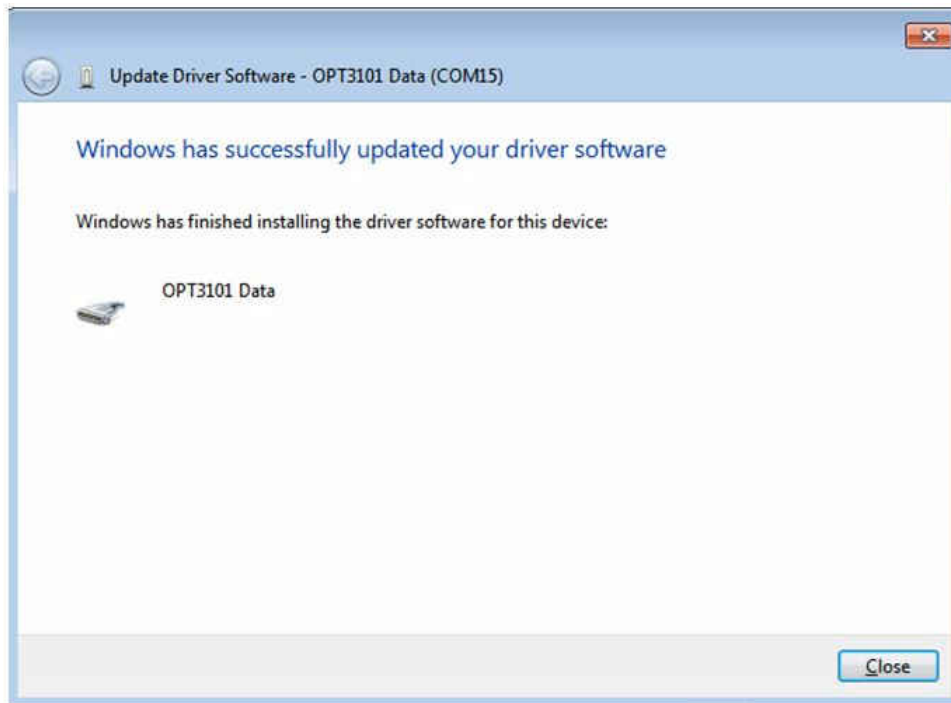

16. The two *USB Serial Device* devices should now appear in the device manager under Ports (COM & LPT) as the following image shows.

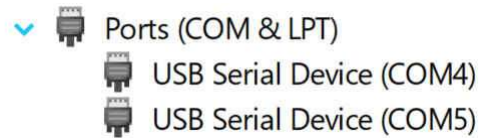

IMPORTANT NOTICE AND DISCLAIMER

TI PROVIDES TECHNICAL AND RELIABILITY DATA (INCLUDING DATA SHEETS), DESIGN RESOURCES (INCLUDING REFERENCE DESIGNS), APPLICATION OR OTHER DESIGN ADVICE, WEB TOOLS, SAFETY INFORMATION, AND OTHER RESOURCES "AS IS" AND WITH ALL FAULTS, AND DISCLAIMS ALL WARRANTIES, EXPRESS AND IMPLIED, INCLUDING WITHOUT LIMITATION ANY IMPLIED WARRANTIES OF MERCHANTABILITY, FITNESS FOR A PARTICULAR PURPOSE OR NON-INFRINGEMENT OF THIRD PARTY INTELLECTUAL PROPERTY RIGHTS.

These resources are intended for skilled developers designing with TI products. You are solely responsible for (1) selecting the appropriate TI products for your application, (2) designing, validating and testing your application, and (3) ensuring your application meets applicable standards, and any other safety, security, regulatory or other requirements.

These resources are subject to change without notice. TI grants you permission to use these resources only for development of an application that uses the TI products described in the resource. Other reproduction and display of these resources is prohibited. No license is granted to any other TI intellectual property right or to any third party intellectual property right. TI disclaims responsibility for, and you will fully indemnify TI and its representatives against, any claims, damages, costs, losses, and liabilities arising out of your use of these resources.

TI's products are provided subject to [TI's Terms of Sale](#) or other applicable terms available either on ti.com or provided in conjunction with such TI products. TI's provision of these resources does not expand or otherwise alter TI's applicable warranties or warranty disclaimers for TI products.

TI objects to and rejects any additional or different terms you may have proposed.

Mailing Address: Texas Instruments, Post Office Box 655303, Dallas, Texas 75265
Copyright © 2022, Texas Instruments Incorporated