

## 7 A very low drop adjustable positive voltage regulator

Datasheet - production data

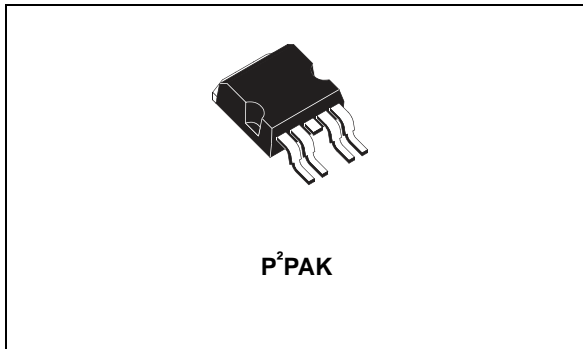

### Description

The LD1580 is a very low-dropout positive linear voltage regulator particularly suitable for applications requiring output currents up to 7 A.

The LD1580 typical dropout voltage is 400 mV at 7 A while it decreases at lighter loads.

The low-dropout is given by a second input voltage pin, named  $V_{\text{CONTROL}}$ , which also drives the output power stage.

The LD1580 is provided with an output voltage remote sense pin which reduces drastically any output voltage variation due to load changes.

The ADJ pin is available. A small capacitor on this pin improves transient response.

The LD1580 also features a built-in output current limit function and a thermal shutdown protection with hysteresis which avoids excessive power dissipation in case of insufficient heatsinking. On-chip trimming allows the regulator to reach a very tight output voltage tolerance, within  $\pm 2\%$  at the maximum output current and over the full temperature range.

### Features

- Output current limit
- Low-dropout voltage: typically 400 mV at 7 A output current
- Output voltage remote sense pin
- Fast transient response
- Thermal shutdown protection with hysteresis
- Wide operating temperature range: from  $-40\text{ }^{\circ}\text{C}$  to  $125\text{ }^{\circ}\text{C}$
- No supply sequencing problems in dual supply mode
- Output voltage available: adjustable

**Table 1. Device summary**

Order code	Packaging
LD1580P2T-R	tape and reel

# Contents

1	Diagram .....	3
2	Pin configuration .....	4
3	Maximum ratings .....	5
4	Typical application .....	6
5	Electrical characteristics .....	7
6	Typical characteristics .....	8
7	Package mechanical data .....	11
8	Packaging mechanical data .....	14
9	Revision history .....	16

# 1 Diagram

Figure 1. Schematic diagram

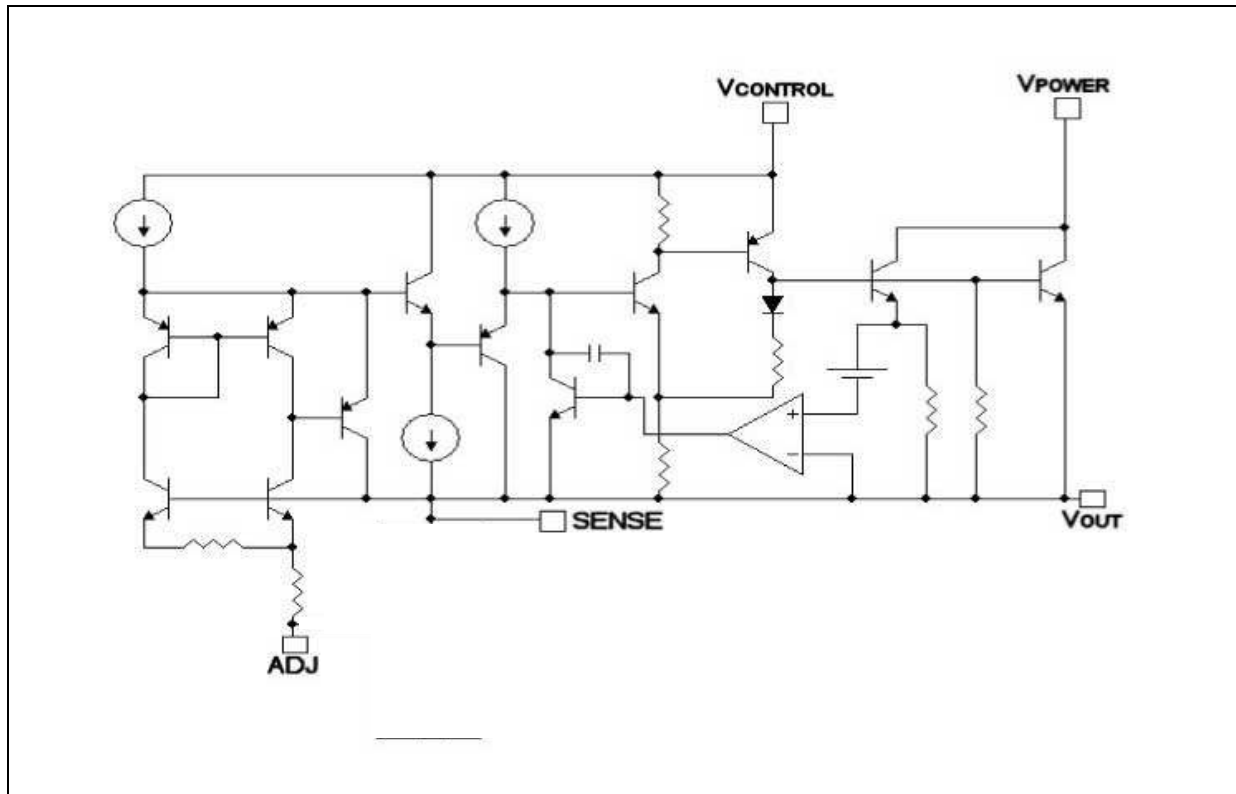

## 2 Pin configuration

Figure 2. Pin connection (top view)

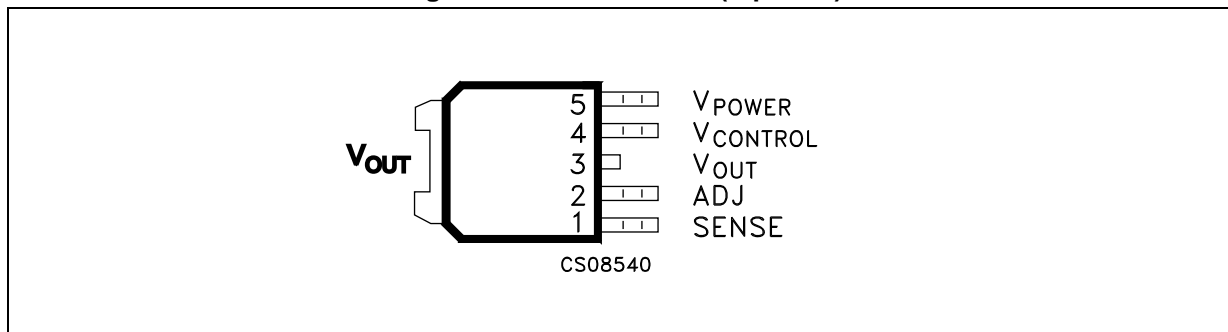

### 3 Maximum ratings

**Table 2. Absolute maximum ratings**

Symbol	Parameter	Value	Unit
$V_{POWER}$	DC $V_{POWER}$ voltage	From -0.3 to 6	V
$V_{CONTROL}$	DC $V_{CONTROL}$ voltage	From -0.3 to 13	V
$I_{OUT}$	Output current	Internally limited	A
$P_D$	Power dissipation	Internally limited	W
$T_{STG}$	Storage temperature range	-55 to +150	°C
$T_{OP}$	Operating junction temperature range	-40 to +125	°C

*Note: Absolute maximum ratings are those values beyond which damage to the device may occur. Functional operation under these conditions is not implied.*

**Table 3. Thermal data**

Symbol	Parameter	P <sup>2</sup> PAK	Unit
$R_{thJC}$	Thermal resistance junction-case	3	°C/W
$R_{thJA}$	Thermal resistance junction-ambient	62.5	°C/W

# 4 Typical application

Figure 3. Typical application circuits

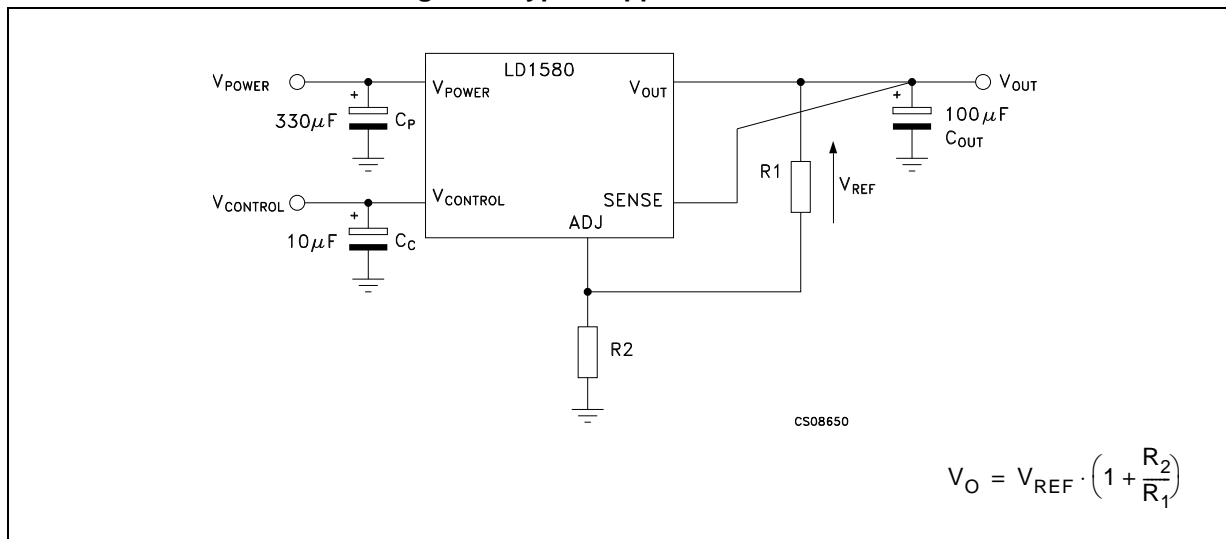

## 5 Electrical characteristics

$T_J = -40\text{ °C}$  to  $125\text{ °C}$ ,  $C_P = 330\text{ }\mu\text{F}$ ,  $C_C = 10\text{ }\mu\text{F}$ ,  $C_{OUT} = 100\text{ }\mu\text{F}$ , unless otherwise specified.

**Table 4. LD1580 electrical characteristics**

Symbol	Parameter	Test conditions	Min.	Typ.	Max.	Unit
$V_O$	Output voltage	$V_{CONTROL}=2.75\text{ V}$ , $V_{POWER}=2\text{ V}$ $T_J=25\text{ °C}$ , $I_{OUT}=10\text{ mA}$	1.237	1.250	1.263	V
		$V_{CONTROL}=2.7\text{ V}$ to $12\text{ V}$ $V_{POWER} = 2.05\text{ V}$ to $5.5\text{ V}$ , $I_{OUT} = 0.01$ to $7\text{ A}$	1.225	1.250	1.275	
$\Delta V_O$	Line regulation	$V_{CONTROL}=2.5\text{ V}$ to $12\text{ V}$ $V_{POWER}=1.75\text{ V}$ to $5.5\text{ V}$ , $I_{OUT}=10\text{ mA}$		0.08	0.24	%
$\Delta V_O$	Load regulation	$V_{CONTROL} = 2.75\text{ V}$ , $V_{POWER} = 2.1\text{ V}$ $I_{OUT} = 0.01$ to $7\text{ A}$		0.08	0.4	%
$I_C$	$V_{CONTROL}$ pin current	$V_{CONTROL} = 2.75\text{ V}$ , $V_{POWER} = 2.05\text{ V}$ $I_{OUT} = 100\text{ mA}$		6	10	mA
		$V_{CONTROL} = 2.75\text{ V}$ , $V_{POWER} = 2.05\text{ V}$ $I_{OUT} = 4\text{ A}$		30	60	
		$V_{CONTROL} = 2.75\text{ V}$ , $V_{POWER} = 1.75\text{ V}$ $I_{OUT} = 4\text{ A}$		33	70	
		$V_{CONTROL} = 2.75\text{ V}$ , $V_{POWER} = 2.05\text{ V}$ $I_{OUT} = 7\text{ A}$		60	120	
$I_{ADJ}$	Adjustable pin current	$V_{CONTROL} = 2.75\text{ V}$ , $V_{POWER} = 2.05\text{ V}$ $I_{OUT} = 10\text{ mA}$		50	120	$\mu\text{A}$
$I_{OUT}$	Output current limit	$V_{CONTROL} = 2.75\text{ V}$ , $V_{POWER} = 2.05\text{ V}^{(1)}$	8	9		A
SVR	Supply voltage rejection	$V_{CONTROL} = V_{POWER} = 3.75\text{ V}$ $V_{RIPPLE} = 1\text{ V}_{P-P}$ , $I_{OUT} = 4\text{ A}$ , $T_J = 25\text{ °C}$	61.5	81.5		dB
$V_{DC}$	Minimum $V_{CONTROL}$ voltage, ( $V_{CONTROL}-V_O$ )	$V_{POWER}=2.05\text{ V}$ , $I_{OUT} = 100\text{ mA}^{(2)}$		0.95	1.15	V
		$V_{POWER} = 2.05\text{ V}$ , $I_{OUT} = 1\text{ A}$		0.95	1.15	
		$V_{POWER} = 2.05\text{ V}$ , $I_{OUT} = 4\text{ A}$		1	1.2	
		$V_{POWER} = 2.05\text{ V}$ , $I_{OUT} = 7\text{ A}$		1.05	1.3	
$V_{DP}$	Minimum $V_{POWER}$ voltage ( $V_{POWER}-V_O$ )	$V_{CONTROL} = 2.75\text{ V}$ , $I_{OUT} = 1\text{ A}^{(2)}$		0.05	0.15	V
		$V_{CONTROL} = 2.75\text{ V}$ , $I_{OUT} = 4\text{ A}$		0.2	0.4	
		$V_{CONTROL} = 2.75\text{ V}$ , $I_{OUT} = 7\text{ A}$		0.4	0.6	
$T_{SHDN}$	Shutdown temperature threshold			170		$^{\circ}\text{C}$
$T_{HYST}$	Thermal shutdown hysteresis			5		$^{\circ}\text{C}$

1. Measured when the  $V_{OUT}$  voltage drops below 100 mV with respect to its nominal value.

2. Measured when the  $V_{OUT}$  voltage drops below 2% with respect to its nominal value.

## 6 Typical characteristics

(Unless otherwise specified  $T_J = 25\text{ }^\circ\text{C}$ ,  $C_P = 330\text{ }\mu\text{F}$ ,  $C_C = 10\text{ }\mu\text{F}$ ,  $C_{OUT} = 100\text{ }\mu\text{F}$ )

**Figure 4. Output voltage vs temperature (no load)**

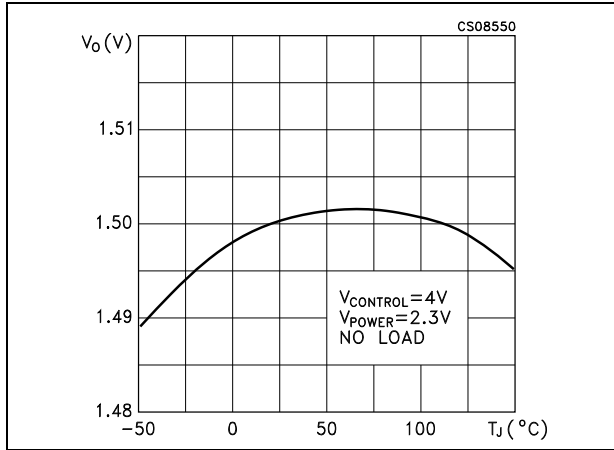

**Figure 5. Minimum  $V_{CONTROL}$  voltage vs temperature**

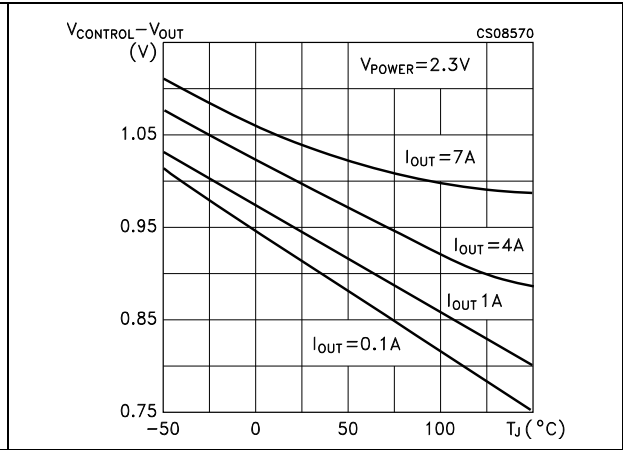

**Figure 6. Minimum  $V_{POWER}$  voltage vs output current**

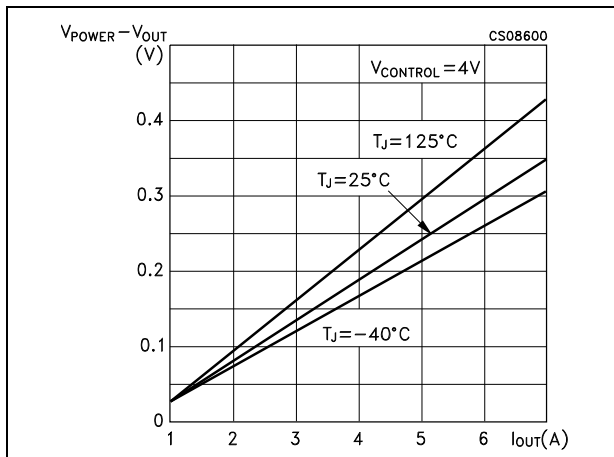

**Figure 7. Output voltage vs temperature ( $I_{OUT} = 7\text{ A}$ )**

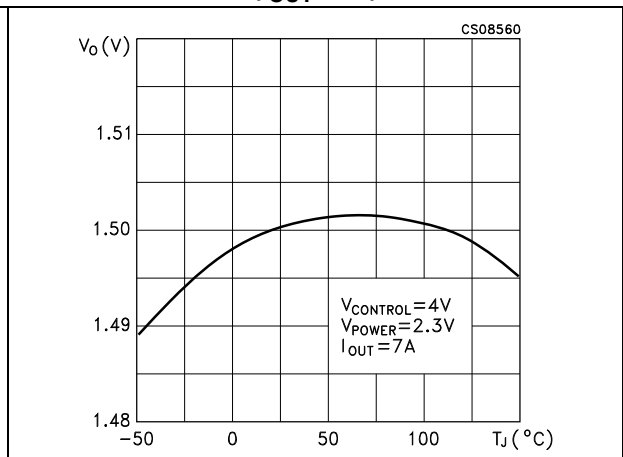



Figure 8.  $V_{CONTROL}$  pin current vs temperature

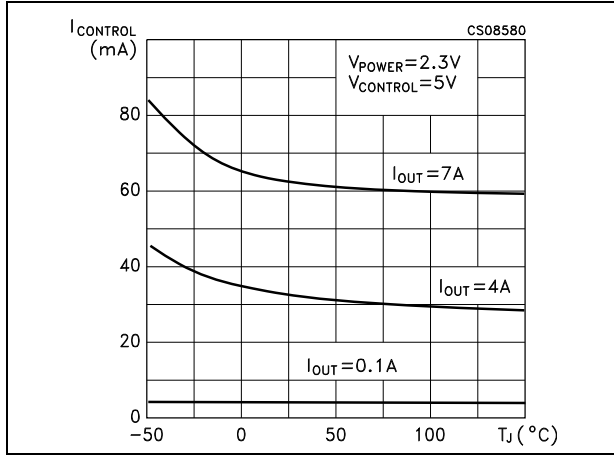

Figure 9. Minimum  $V_{POWER}$  voltage vs temperature

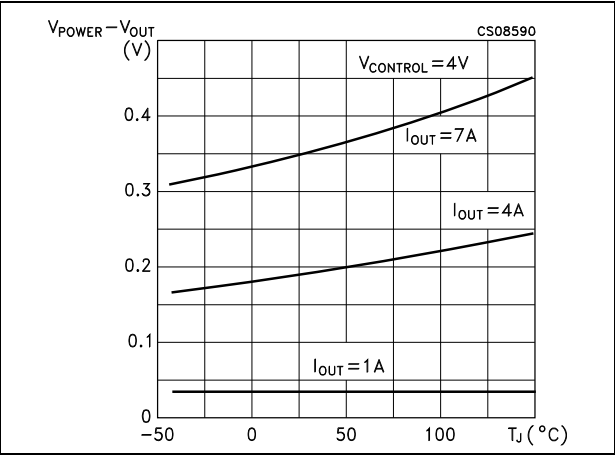

Figure 10.  $V_{CONTROL}$  pin current vs output current

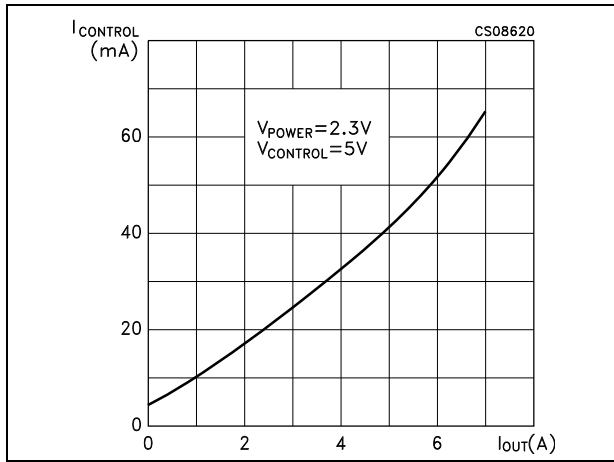

Figure 11. Output current limit vs temperature

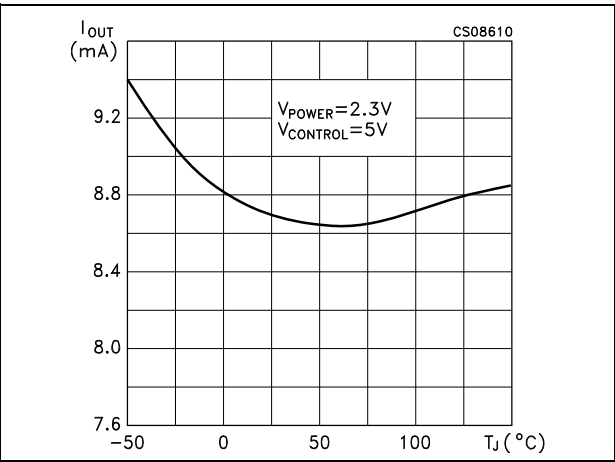

Figure 12. Quiescent current vs temperature

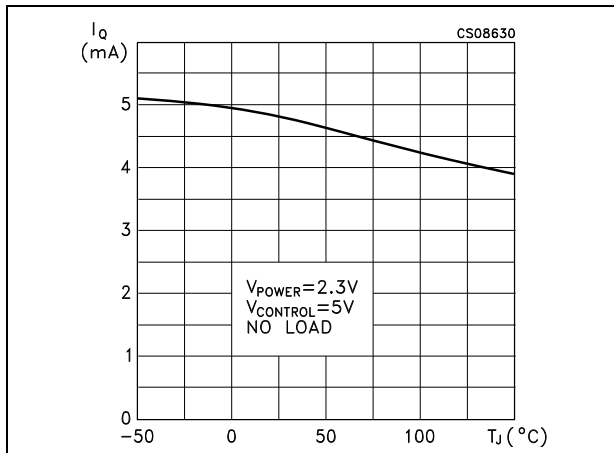

Figure 13. Supply voltage rejection vs output current

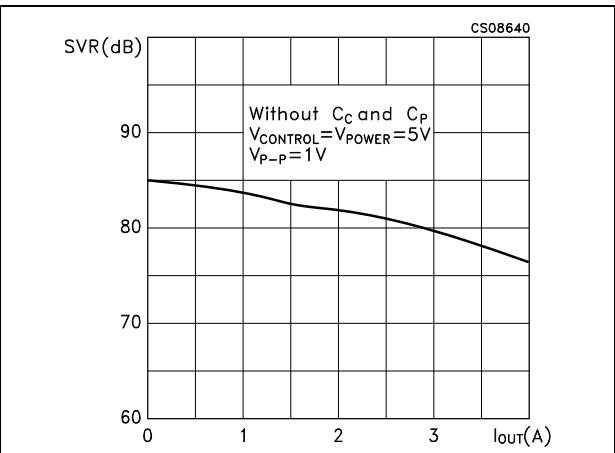

Figure 14. Line transient response  $V_{Power}=3.3\text{ V}$

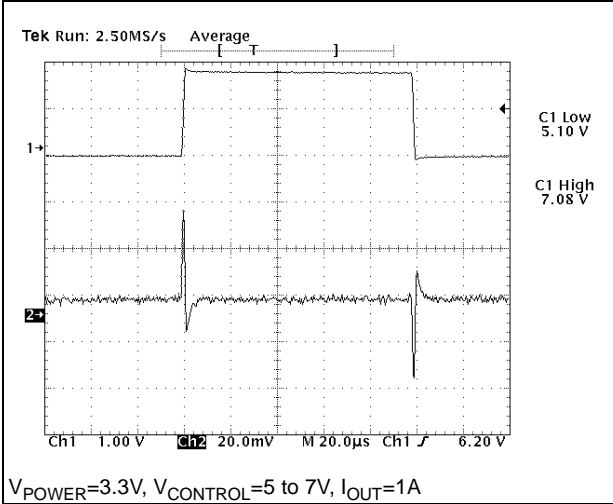

Figure 15. Line transient response  $V_{Power}=5\text{ V}$

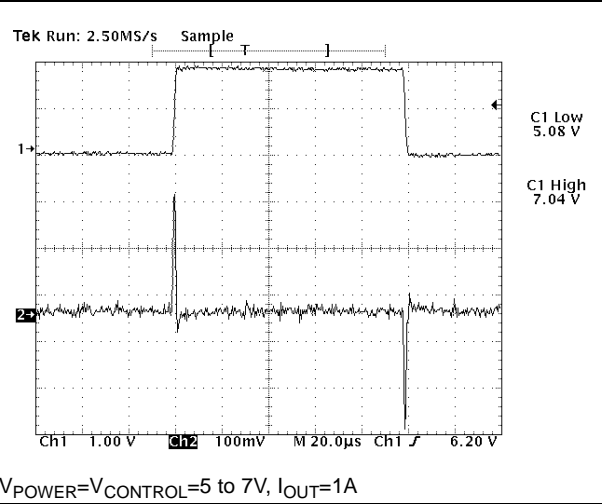

Figure 16. Load transient response

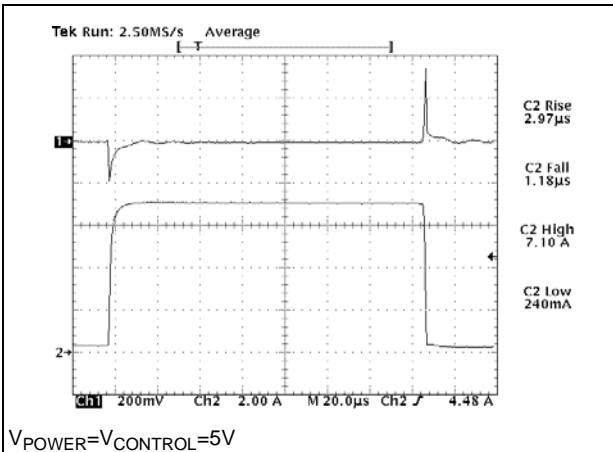

Figure 17. Load transient response (falling edge)

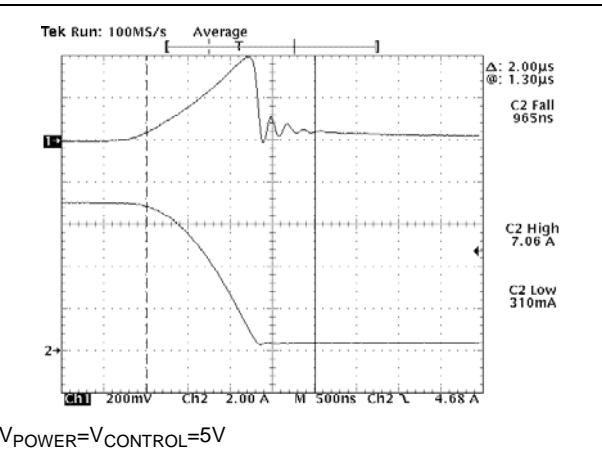
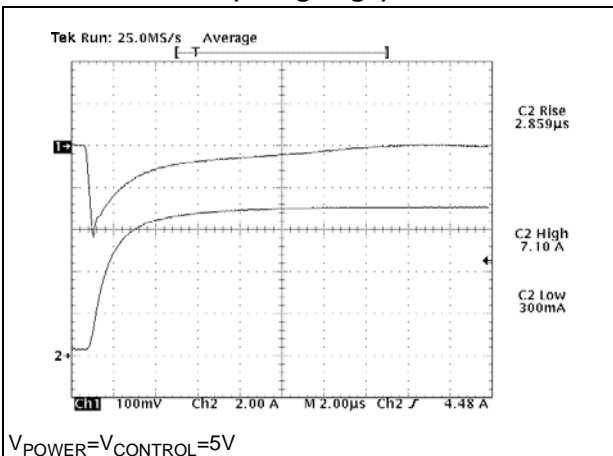

Figure 18. Load transient response (rising edge)



## 7 Package mechanical data

In order to meet environmental requirements, ST offers these devices in different grades of ECOPACK<sup>®</sup> packages, depending on their level of environmental compliance. ECOPACK<sup>®</sup> specifications, grade definitions and product status are available at: [www.st.com](http://www.st.com). ECOPACK<sup>®</sup> is an ST trademark.

Figure 19. P<sup>2</sup>PAK drawings

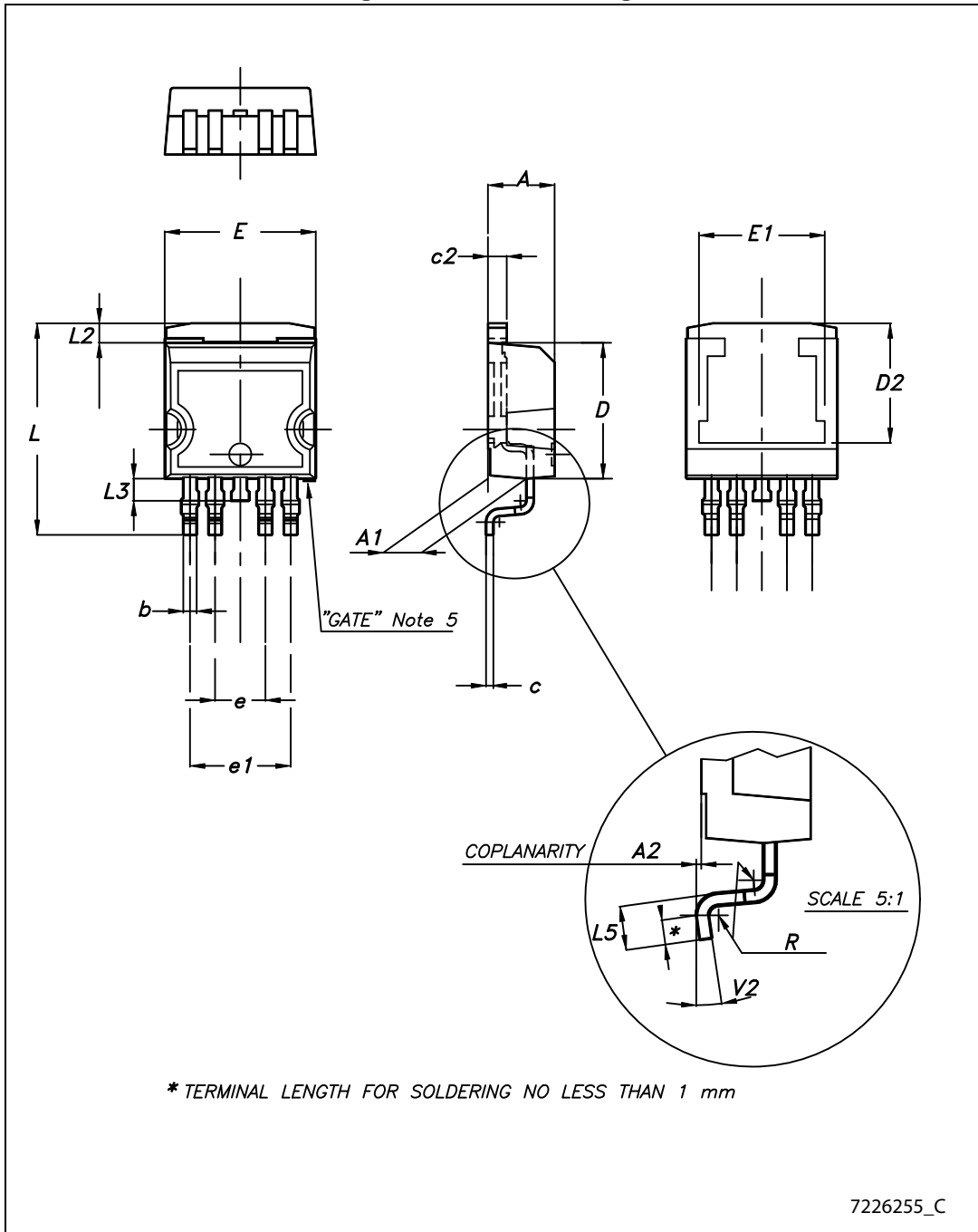
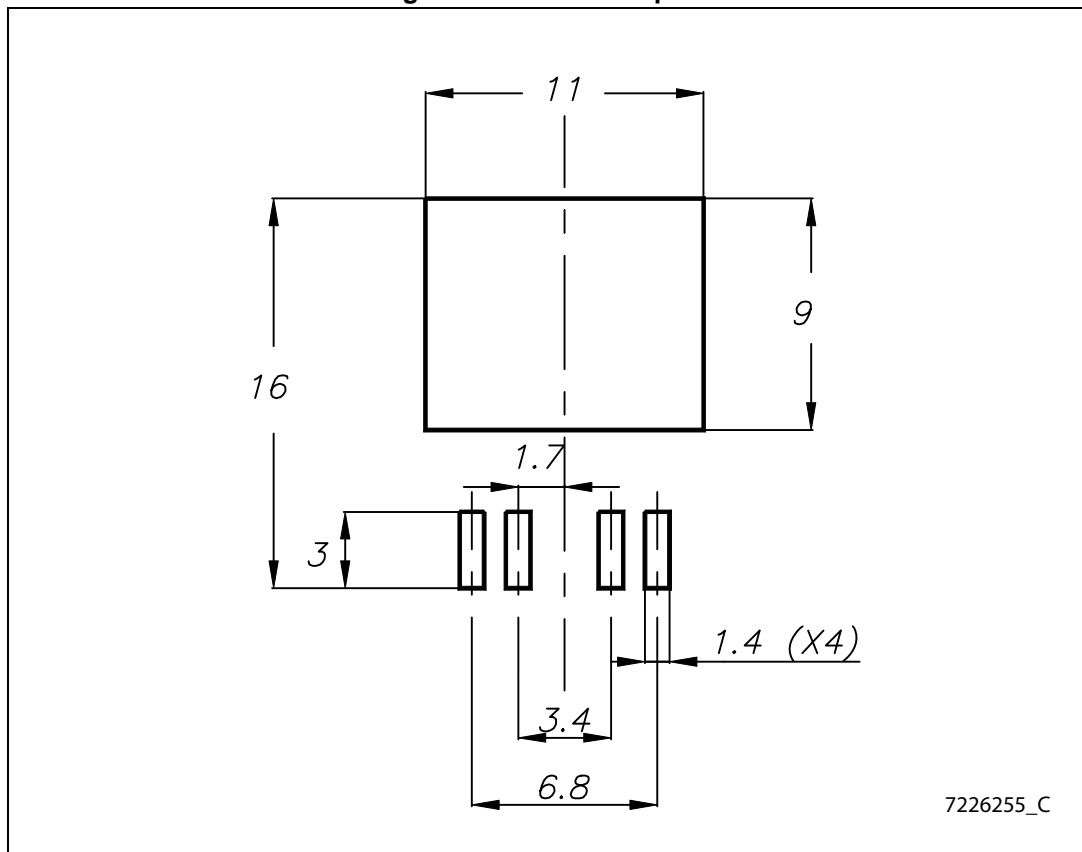

Table 5. P<sup>2</sup>PAK mechanical data

Dim.	mm		
	Min.	Typ.	Max.
A	4.30		4.80
A1	2.40		2.80
A2	0.03		0.23
b	0.80		1.05
c	0.45		0.60
c2	1.17		1.37
D	8.95		9.35
D2		8	
E	10		10.40
E1		8.5	
e	3.20		3.60
e1	6.60		7
L	13.70		14.50
L2	1.25		1.40
L3	0.90		1.70
L5	1.55		2.40
R		0.40	
V2	0°		8°

Figure 20. P<sup>2</sup>PAK footprint

# 8 Packaging mechanical data

Figure 21. P<sup>2</sup>PAK tape and reel dimensions

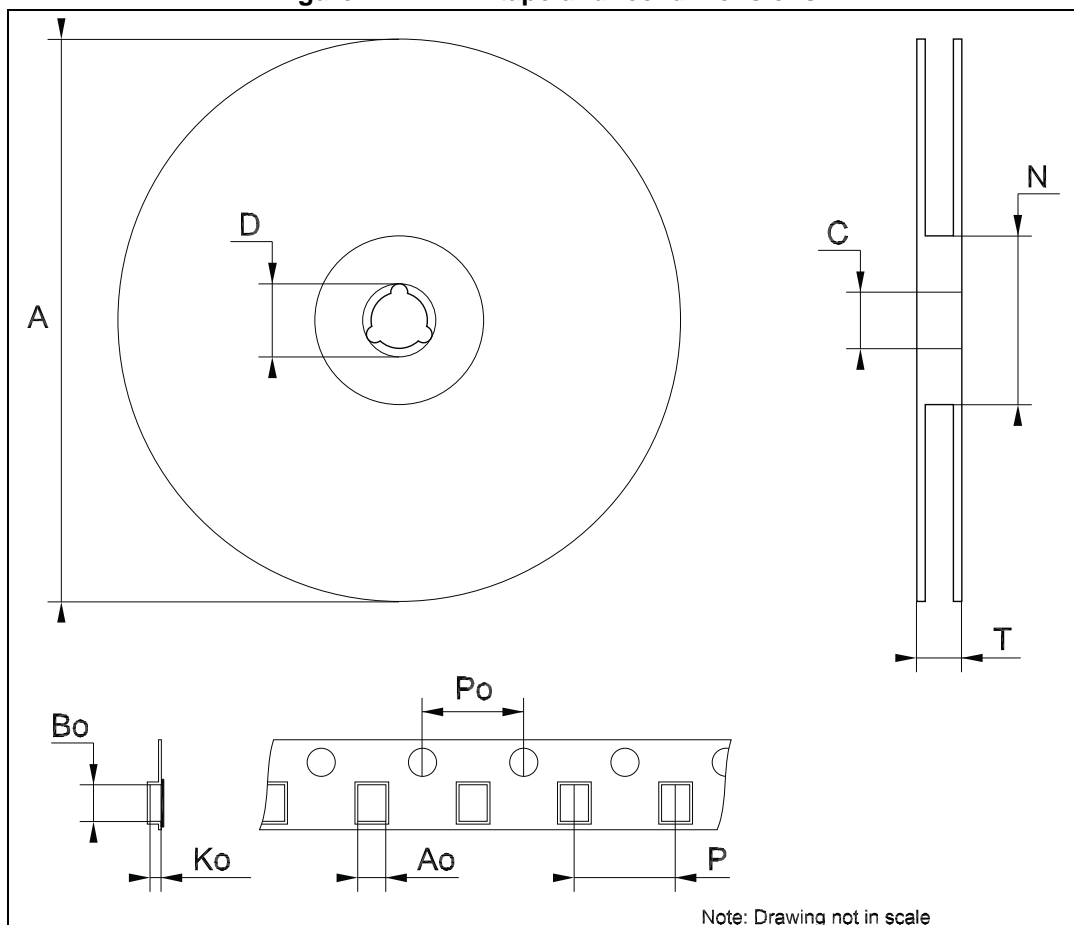

Table 6. P<sup>2</sup>PAK tape and reel mechanical data

Dim.	mm		
	Min.	Typ.	Max.
A			180
C	12.8	13	13.2
D	20.2		
N	60		
T			14.4
Ao	10.50	10.6	10.70
Bo	15.70	15.80	15.90
Ko	4.80	4.90	5.00
Po	3.9	4.0	4.1
P	11.9	12.0	12.1

## 9 Revision history

**Table 7. Document revision history**

Date	Revision	Changes
08-Sep-2005	3	Order codes updated.
09-May-2007	4	Order codes updated.
16-Apr-2008	5	Modified: <a href="#">Table 1 on page 1</a> .
28-Feb-2014	6	Changed the part number LD1580xx to LD1580. Updated the title in cover page. Updated <a href="#">Figure 1: Schematic diagram</a> , <a href="#">Figure 2: Pin connection (top view)</a> , <a href="#">Section 6: Typical characteristics</a> , <a href="#">Section 7: Package mechanical data</a> . Added <a href="#">Section 8: Packaging mechanical data</a> . Minor text changes.



**Please Read Carefully:**

Information in this document is provided solely in connection with ST products. STMicroelectronics NV and its subsidiaries (“ST”) reserve the right to make changes, corrections, modifications or improvements, to this document, and the products and services described herein at any time, without notice.

All ST products are sold pursuant to ST’s terms and conditions of sale.

Purchasers are solely responsible for the choice, selection and use of the ST products and services described herein, and ST assumes no liability whatsoever relating to the choice, selection or use of the ST products and services described herein.

No license, express or implied, by estoppel or otherwise, to any intellectual property rights is granted under this document. If any part of this document refers to any third party products or services it shall not be deemed a license grant by ST for the use of such third party products or services, or any intellectual property contained therein or considered as a warranty covering the use in any manner whatsoever of such third party products or services or any intellectual property contained therein.

**UNLESS OTHERWISE SET FORTH IN ST’S TERMS AND CONDITIONS OF SALE ST DISCLAIMS ANY EXPRESS OR IMPLIED WARRANTY WITH RESPECT TO THE USE AND/OR SALE OF ST PRODUCTS INCLUDING WITHOUT LIMITATION IMPLIED WARRANTIES OF MERCHANTABILITY, FITNESS FOR A PARTICULAR PURPOSE (AND THEIR EQUIVALENTS UNDER THE LAWS OF ANY JURISDICTION), OR INFRINGEMENT OF ANY PATENT, COPYRIGHT OR OTHER INTELLECTUAL PROPERTY RIGHT.**

**ST PRODUCTS ARE NOT DESIGNED OR AUTHORIZED FOR USE IN: (A) SAFETY CRITICAL APPLICATIONS SUCH AS LIFE SUPPORTING, ACTIVE IMPLANTED DEVICES OR SYSTEMS WITH PRODUCT FUNCTIONAL SAFETY REQUIREMENTS; (B) AERONAUTIC APPLICATIONS; (C) AUTOMOTIVE APPLICATIONS OR ENVIRONMENTS, AND/OR (D) AEROSPACE APPLICATIONS OR ENVIRONMENTS. WHERE ST PRODUCTS ARE NOT DESIGNED FOR SUCH USE, THE PURCHASER SHALL USE PRODUCTS AT PURCHASER’S SOLE RISK, EVEN IF ST HAS BEEN INFORMED IN WRITING OF SUCH USAGE, UNLESS A PRODUCT IS EXPRESSLY DESIGNATED BY ST AS BEING INTENDED FOR “AUTOMOTIVE, AUTOMOTIVE SAFETY OR MEDICAL” INDUSTRY DOMAINS ACCORDING TO ST PRODUCT DESIGN SPECIFICATIONS. PRODUCTS FORMALLY ESCC, QML OR JAN QUALIFIED ARE DEEMED SUITABLE FOR USE IN AEROSPACE BY THE CORRESPONDING GOVERNMENTAL AGENCY.**

Resale of ST products with provisions different from the statements and/or technical features set forth in this document shall immediately void any warranty granted by ST for the ST product or service described herein and shall not create or extend in any manner whatsoever, any liability of ST.

ST and the ST logo are trademarks or registered trademarks of ST in various countries.

Information in this document supersedes and replaces all information previously supplied.

The ST logo is a registered trademark of STMicroelectronics. All other names are the property of their respective owners.

© 2014 STMicroelectronics - All rights reserved

STMicroelectronics group of companies

Australia - Belgium - Brazil - Canada - China - Czech Republic - Finland - France - Germany - Hong Kong - India - Israel - Italy - Japan - Malaysia - Malta - Morocco - Philippines - Singapore - Spain - Sweden - Switzerland - United Kingdom - United States of America

[www.st.com](http://www.st.com)

