

パネル切抜寸法 (参考)

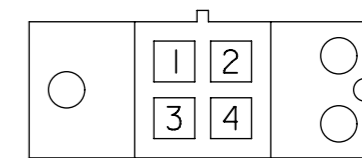

4極

回路レイアウト図

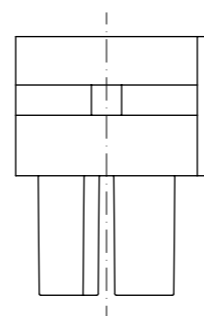
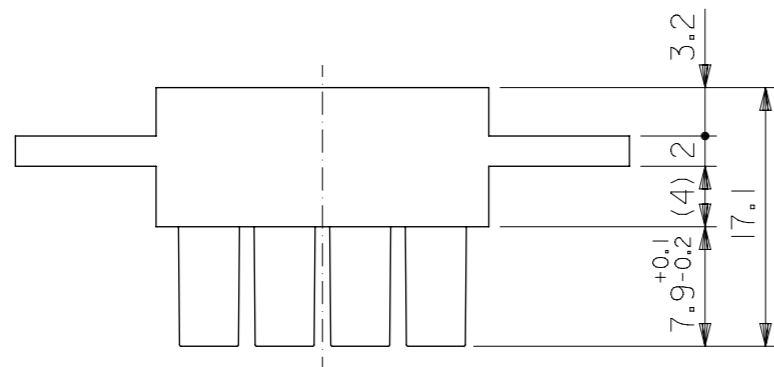

注記

- 適用ターミナル: 5556 シリーズ
- 嵌合相手: 52025-***I*
- パネル外一外寸法 18.6 (下図参照)

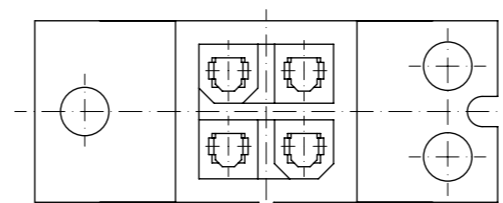
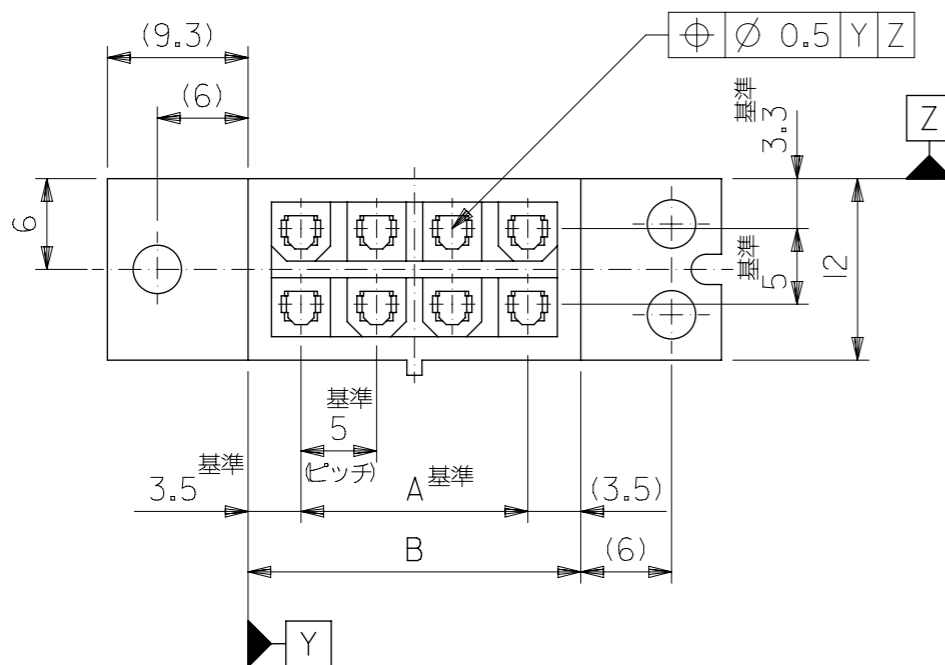
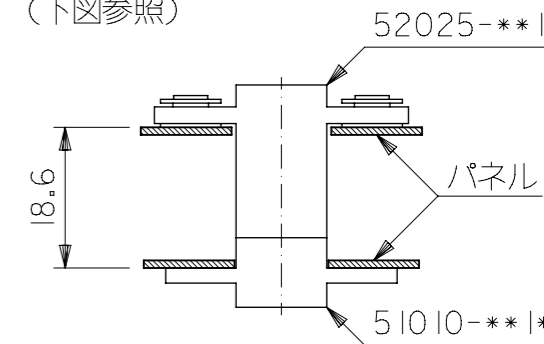

4 CIRCUIT SHOWN

12.4	6	30.6	24	12	5	51010-0411	黒色	4
F	E	D	C	B	A	ENG. NO.		極数

THIS DRAWING CONTAINS INFORMATION THAT IS PROPRIETARY TO MOLEX ELECTRONIC TECHNOLOGIES, LLC AND SHOULD NOT BE USED WITHOUT WRITTEN PERMISSION									
DIMENSION UNITS		SCALE		CURRENT REV DESC: OBSOLETE PART NO					
mm		NTS							
GENERAL TOLERANCES (UNLESS SPECIFIED)									
		MM	INCH	IMP REC. HOUSING PRODUCT CUSTOMER DRAWING					
4 PLACES	± 0.2	±							
3 PLACES	± 0.25	±							
2 PLACES	± 0.3	±							
1 PLACE	±	±							
INITIAL REVISION:				DOCUMENT NUMBER		DOC TYPE		DOC PART REVISION	
0 PLACES ± ±				SD-51010-001		PSD		001 F	
ANGULAR TOL ± 3.0°				SERIES		MATERIAL NUMBER		CUSTOMER	
DRAFT WHERE APPLICABLE MUST REMAIN WITHIN DIMENSIONS				A3-SIZE		51010		GENERAL MARKET	
THIRD ANGLE PROJECTION				DRAWING		SHEET NUMBER		1 OF 2	

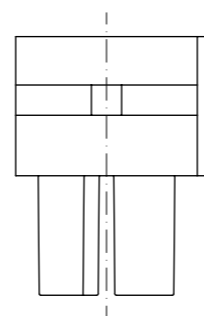
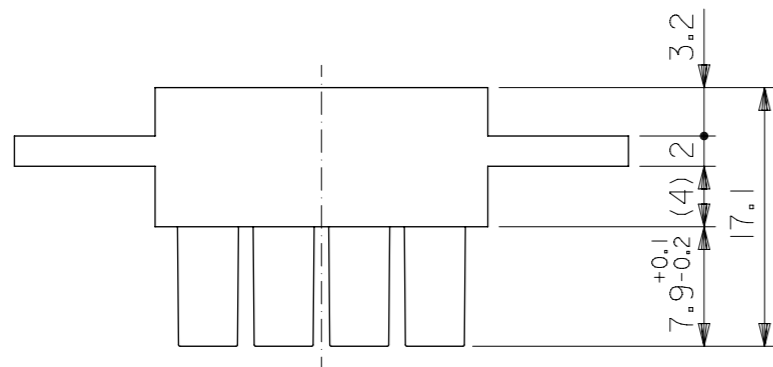
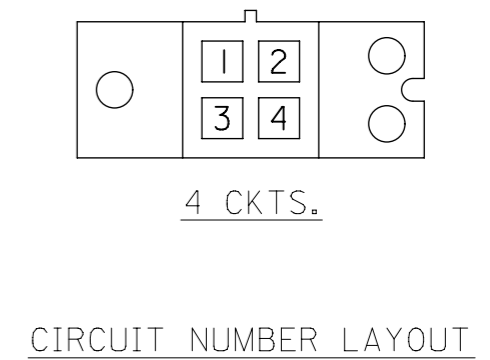
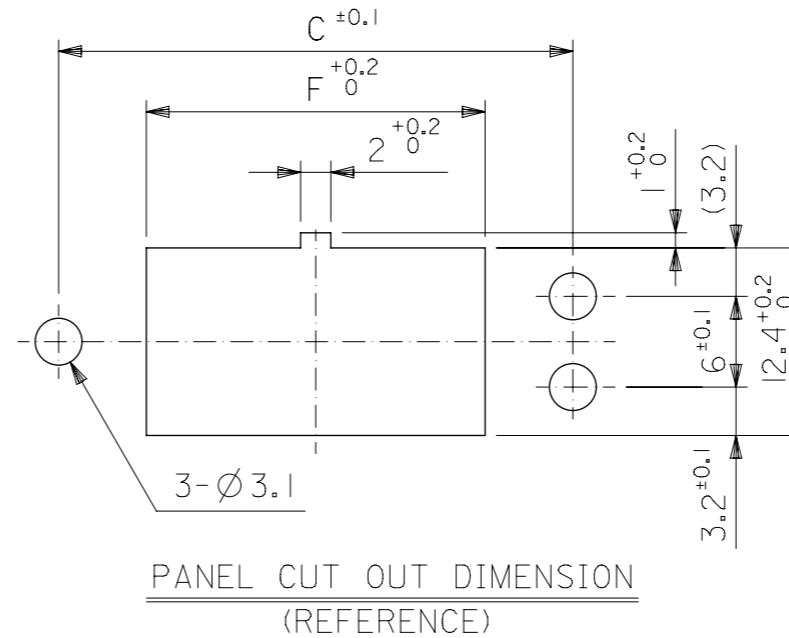
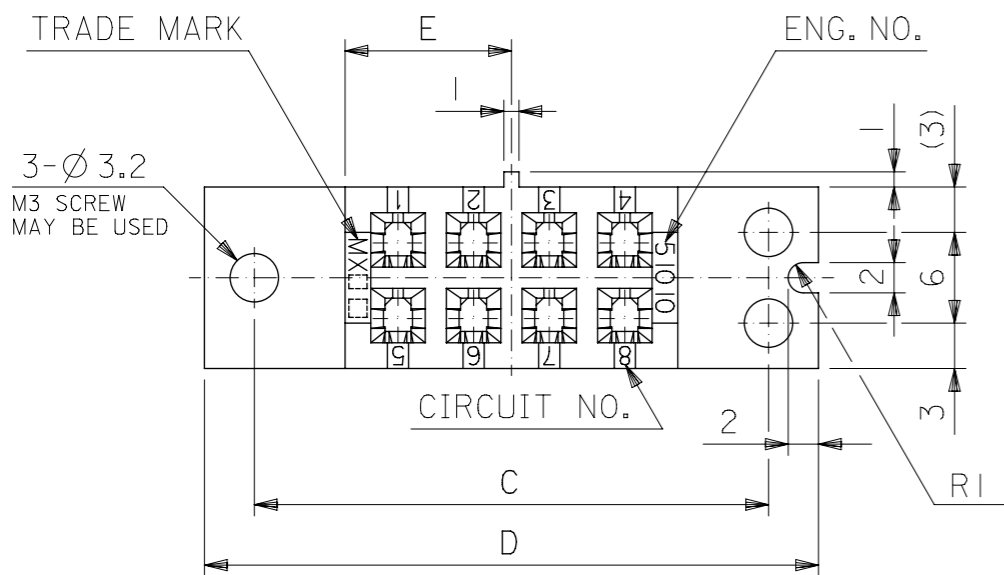

NOTES

1. APPLICABLE TERMINAL : 5556 SERIES
2. MATES WITH : 52025-***I*
3. BETWEEN PANEL-PANEL DIMENSION : 18.6 (SEE BELOW FIGURE)

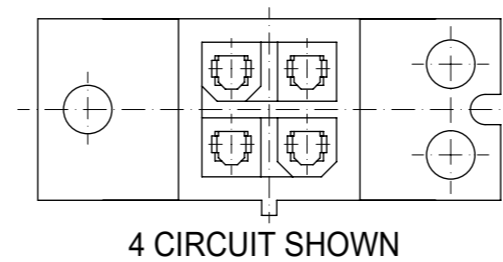
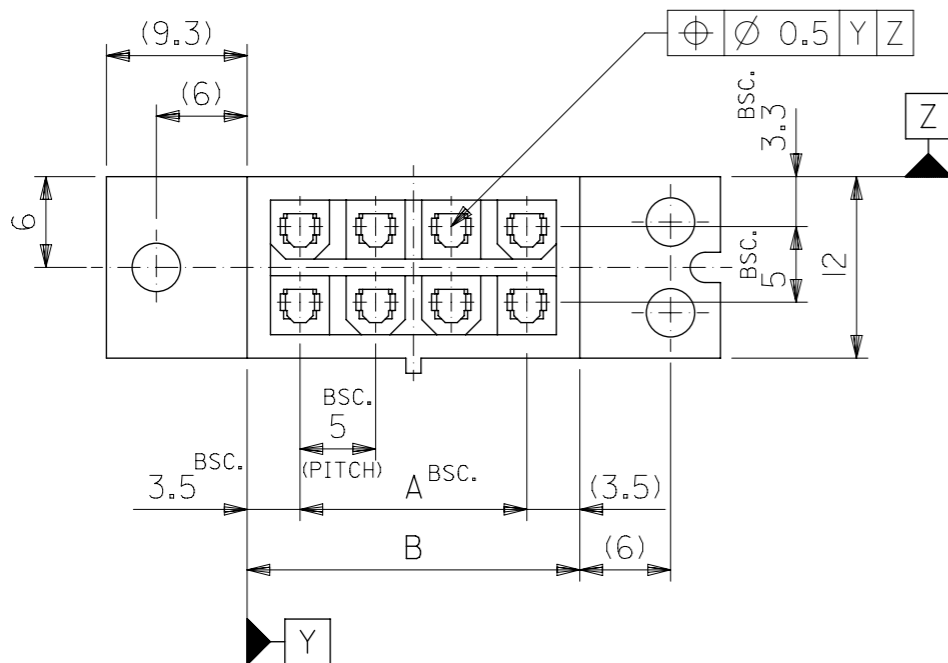
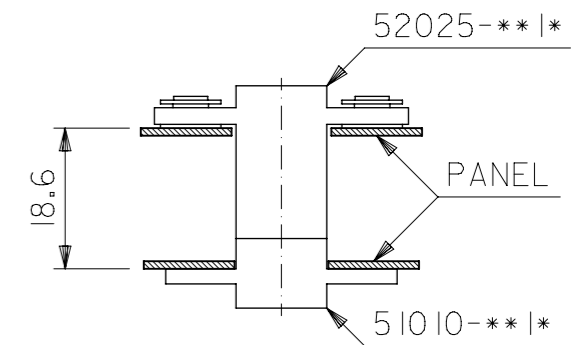

12.4	6	30.6	24	12	5	51010-0411	BLACK	4
F	E	D	C	B	A	ENG. NO.	COLOR	NO. OF CKTS.

THIS DRAWING CONTAINS INFORMATION THAT IS PROPRIETARY TO MOLEX ELECTRONIC TECHNOLOGIES, LLC AND SHOULD NOT BE USED WITHOUT WRITTEN PERMISSION									
DIMENSION UNITS		SCALE		CURRENT REV DESC: OBSOLETE PART NO					
mm		NTS							
GENERAL TOLERANCES (UNLESS SPECIFIED)									
		MM	INCH	IMP REC. HOUSING PRODUCT CUSTOMER DRAWING					
4 PLACES	± 0.2	±							
3 PLACES	± 0.25	±							
2 PLACES	± 0.3	±							
1 PLACE	±	±							
INITIAL REVISION:				DOCUMENT NUMBER		DOC TYPE		DOC PART REVISION	
0 PLACES ± ±				SD-51010-001		PSD		001 F	
ANGULAR TOL ± 3.0°				MATERIAL NUMBER		CUSTOMER		SHEET NUMBER	
DRAFT WHERE APPLICABLE MUST REMAIN WITHIN DIMENSIONS				THIRD ANGLE PROJECTION		DRAWING		SERIES	
						A3-SIZE		51010	
				SEE TABLE		GENERAL MARKET		2 OF 2	