



# High Speed CMOS 3.3V 16-Bit Bidirectional Transceiver

QS74LCX16245

## FEATURES/BENEFITS

- 5V tolerant inputs and outputs
- 10 $\mu$ A  $I_{CCQ}$  quiescent power supply current
- Hot insertable
- 2.0V-3.6V  $V_{CC}$  supply operation
- $\pm 24$ mA balanced output drive
- Power down high impedance inputs and outputs
- C speed performance:  $t_{PD} = 4.1$ ns
- Input hysteresis for noise immunity
- Meets or exceeds JEDEC Standard 36 specifications
- Multiple power and ground pins for low noise
- Operating temperature range:  
-40°C to +85°C
- Latch-up performance exceeds 500mA
- ESD performance:  
Human body model > 2000V  
Machine model > 200V
- Packages available:  
48-pin TSSOP  
48-pin SSOP

## DESCRIPTION

The QS74LCX16245 is a 16-bit transceiver that is ideal for driving bidirectional address and data buses. This device can be used as either two independent 8-bit transceivers or one 16-bit transceiver determined by the Direction and Output Enable controls. The 3.3V LCX family features low power, low switching noise, and fast switching speeds for low power portable applications as well as high-end, advanced workstation applications. 5V tolerant inputs and outputs allow this LCX product to be used in mixed 5V and 3.3V applications. Easy board layout is facilitated by the use of flow-through pinouts and byte enable controls provide architectural flexibility for systems designers. To accommodate hot-plug or live insertion applications, this product is designed not to load an active bus when  $V_{CC}$  is removed.

Figure 1. Functional Block Diagram

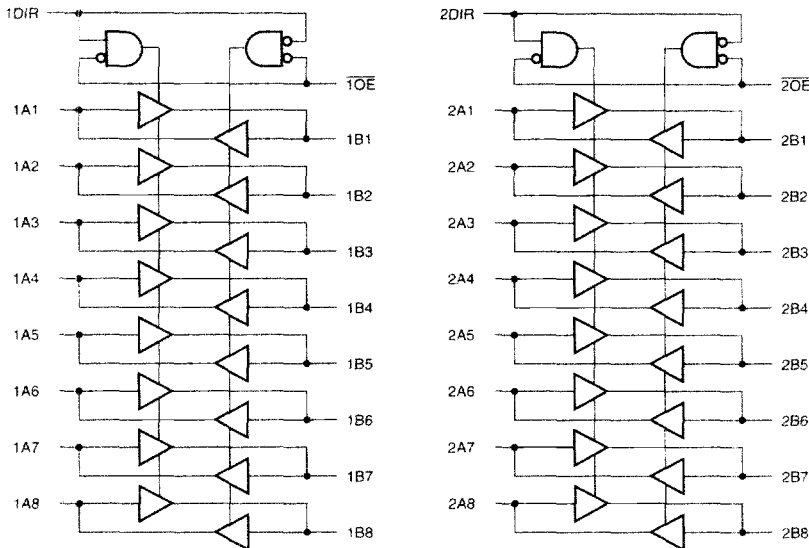

**Figure 2. Pin Configuration**  
(All Pins Top View)

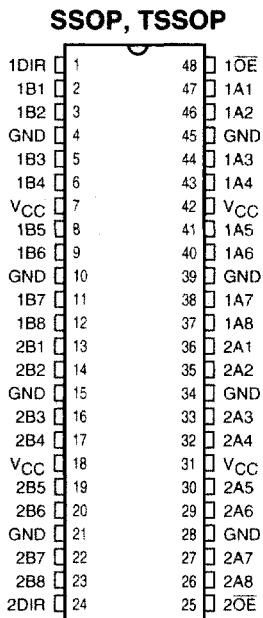

**Table 1. Pin Description**

| Name | Description            |
|------|------------------------|
| xDIR | Transmit/Receive Input |
| xOE  | Output Enable Inputs   |
| xAx  | Bus A                  |
| xBx  | Bus B                  |

**Table 2. Function Table**

| Inputs |      | Outputs             |
|--------|------|---------------------|
| xOE    | xDIR |                     |
| L      | L    | Bus B Data to Bus A |
| L      | H    | Bus A Data to Bus B |
| H      | X    | Hi-Z                |



**Table 3. Capacitance**

| Symbol           | Pins                          | Typ | Unit | Conditions  |
|------------------|-------------------------------|-----|------|---|
| C <sub>IN</sub>  | Input Capacitance             | 7.0 | pF   | V <sub>IN</sub> = 0V, V <sub>OUT</sub> = 0V, f = 1MHz                       |
| C <sub>I/O</sub> | I/O Capacitance               | 8.0 | pF   | V <sub>IN</sub> = 0V, V <sub>OUT</sub> = 0V, f = 1MHz                       |
| C <sub>PD</sub>  | Power Dissipation Capacitance | 20  | pF   | V <sub>CC</sub> = 3.3V, V <sub>IN</sub> = 0 or V <sub>CC</sub><br>f = 10MHz |

**Note:** Capacitance is characterized but not production tested.

**Table 4. Absolute Maximum Ratings**

|   |                                 |
|---|---------------------------------|
| Supply Voltage to Ground  | -0.5V to +7.0V                  |
| DC Output Voltage V <sub>OUT</sub>                                |                                 |
| Outputs HIGH-Z  | -0.5V to +7.0V                  |
| Outputs Active  | -0.5V to V <sub>CC</sub> + 0.5V |
| DC Input Voltage V <sub>IN</sub>                                  | -0.5V to 7.0V                   |
| DC Input Diode Current with V <sub>IN</sub> < 0                   | -50mA                           |
| DC Output Diode Current   |                                 |
| V <sub>O</sub> < 0  | -50mA                           |
| V <sub>O</sub> > V <sub>CC</sub>                                  | +50mA                           |
| DC Output Source/Sink Current (I <sub>OH</sub> /I <sub>OL</sub> ) | ±50mA                           |
| DC Supply Current per Supply Pin                                  | ±100mA                          |
| DC Ground Current per Ground Pin                                  | ±100mA                          |
| T <sub>STG</sub> Storage Temperature                              | -65°C to +150°C                 |

**Note:** Stresses greater than those listed under ABSOLUTE MAXIMUM RATINGS may cause permanent damage to this device resulting in functional or reliability type failures.

Table 5. Recommended Operating Conditions

| Symbol              | Parameter  | Min | Max                  | Unit |
|---------------------|--|-----|----------------------|------|
| $V_{CC}$            | Supply Voltage, Operating                                  | 2.0 | 3.6                  | V    |
| $V_{IN}$            | Input Voltage  | 0   | 5.5                  | V    |
| $V_{OUT}$           | Output Voltage in Active State                             | 0   | $V_{CC}$             | V    |
| $V_{OUT}$           | Output Voltage in "OFF" State                              | 0   | 5.5                  | V    |
| $I_{OH}/I_{OL}$     | Output Current<br>$V_{CC} = 3.0 - 3.6V$<br>$V_{CC} = 2.7V$ | —   | $\pm 24$<br>$\pm 12$ | mA   |
| $\Delta t/\Delta v$ | Input Transition Slew Rate                                 | —   | 10                   | ns/V |
| $T_A$               | Operating Free Air Temperature                             | -40 | +85                  | °C   |

Table 6. DC Electrical Characteristics Over Operating Range

Industrial Temperature Range,  $T_A = -40^\circ\text{C}$  to  $+85^\circ\text{C}$ 

| Symbol       | Parameter                              | Test Conditions <sup>(1)</sup>   | Min                               | Typ <sup>(2)</sup> | Max                      | Unit    |
|--------------|--|--|-----------------------------------|--------------------|--------------------------|---------|
| $V_{IH}$     | Input HIGH Voltage                     | Logic HIGH for All Inputs  | 2.0                               | —                  | —                        | V       |
| $V_{IL}$     | Input LOW Voltage                      | Logic LOW for All Inputs   | —                                 | —                  | 0.8                      | V       |
| $V_{OH}$     | Output HIGH Voltage                    | $V_{CC} = 2.7V, I_{OH} = -100\mu A$<br>$V_{CC} = 2.7V, I_{OH} = -12mA$<br>$V_{CC} = 3.0V, I_{OH} = -18mA$<br>$V_{CC} = 3.0V, I_{OH} = -24mA$ | $V_{CC}-0.2$<br>2.2<br>2.4<br>2.2 | —<br>—<br>—<br>—   | —<br>—<br>—<br>—         | V       |
| $V_{OL}$     | Output LOW Voltage                     | $V_{CC} = 2.7V, I_{OL} = 100\mu A$<br>$V_{CC} = 2.7V, I_{OL} = 12mA$<br>$V_{CC} = 3.0V, I_{OL} = 16mA$<br>$V_{CC} = 3.0V, I_{OL} = 24mA$     | —<br>—<br>—<br>—                  | —<br>—<br>—<br>—   | 0.2<br>0.4<br>0.4<br>0.5 | V       |
| $\Delta V_T$ | Input Hysteresis <sup>(3)</sup>        | $V_{TLH} - V_{THL}$ for All Inputs   | —                                 | 150                | —                        | mV      |
| $I_I$        | Input Leakage Current                  | $V_I = 0V, V_I = 5.5V, V_{CC} = 3.6V$  | —                                 | —                  | $\pm 1.0$                | $\mu A$ |
| $I_{OZ}$     | High-Z I/O Leakage                     | $V_O = 0V, V_O = 5.5V$<br>$V_I = V_{IH}$ or $V_{IL}, V_{CC} = 3.6V$  | —                                 | —                  | $\pm 1.0$                | $\mu A$ |
| $I_{OS}$     | Short Circuit Current <sup>(3,4)</sup> | $V_{CC} = 3.6V, V_O = GND$   | -60                               | —                  | -240                     | mA      |
| $I_{OFF}$    | Power Off Leakage                      | $V_{CC} = 0V, V_I$ or $V_O = 5.5V$   | —                                 | —                  | 10                       | $\mu A$ |
| $V_{IK}$     | Input Clamp Voltage                    | $V_{CC} = 2.7V, I_{IN} = -18mA$  | —                                 | -0.7               | -1.2                     | V       |

**Notes:**

1. For conditions shown as Max or Min use appropriate value specified under Recommended Operating Conditions for the applicable device type.
2. Typical values are at  $V_{CC} = 3.3V$ , and  $T_A = 25^\circ\text{C}$ .
3. These parameters are guaranteed by characterization, but not production tested.
4. Not more than one output should be tested at one time. Duration of test should not exceed one second.

**Table 7. Power Supply Characteristics**

| Symbol          | Parameter                                       | Test Conditions <sup>(1)</sup>  | Typ <sup>(2)</sup>                       | Max                | Unit               |    |
|-----------------|---|---|--|--------------------|--------------------|----|
| $I_{CC}$        | Quiescent Power Supply Current                  | $V_{CC} = 3.6V$ , Freq = 0<br>$V_{IN} = GND$ or $V_{CC}$  | 0.1                                      | 10                 | $\mu A$            |    |
| $\Delta I_{CC}$ | Supply Current per Input @ TTL HIGH             | $V_{CC} = 3.6V$ , $V_{IN} = V_{CC}-0.6V$ <sup>(3)</sup>   | 2.0                                      | 30                 | $\mu A$            |    |
| $I_{CCD}$       | Supply Current per Input per MHz <sup>(4)</sup> | $V_{CC} = 3.6V$ , Outputs Open<br>One Bit Toggling @ 50% Duty Cycle<br>$x\overline{OE} = GND$                       | 50                                       | 75                 | $\mu A / MHz$      |    |
| $I_C$           | Total Power Supply Current <sup>(6)</sup>       | $V_{CC} = 3.6V$ , Outputs Open<br>One Bit Toggling @ 50% Duty Cycle<br>$x\overline{OE} = GND$ , $f_i = 10MHz$       | $V_{IN} = V_{CC}-0.6V$<br>$V_{IN} = GND$ | 0.5 <sup>(5)</sup> | 0.8 <sup>(5)</sup> | mA |
|                 |   | $V_{CC} = 3.6V$ , Outputs Open<br>Sixteen Bits Toggling @ 50% Duty Cycle<br>$x\overline{OE} = GND$ , $f_i = 2.5MHz$ | $V_{IN} = V_{CC}-0.6V$<br>$V_{IN} = GND$ | 2.0 <sup>(5)</sup> | 3.3 <sup>(5)</sup> |    |

3

**Notes:**

- For conditions shown as Min. or Max., use the appropriate values specified under Recommended Operating Conditions for applicable device type.
- Typical values are at  $V_{CC} = 3.3V$ , +25°C ambient.
- Per TTL driven input. All Other Inputs at  $V_{CC}$  or GND.
- This parameter is not directly testable, but is derived for use in Total Power Supply Calculations.
- Values for these conditions are examples of the  $I_{CC}$  formula. These limits are guaranteed by design but not tested.
- $I_C = I_{QUIESCENT} + I_{INPUTS} + I_{DYNAMIC}$   
 $I_C = I_{CCQ} + \Delta I_{CC} D_H N_T + I_{CCD} f N_O$   
 $I_{CCQ}$  = Quiescent Current ( $I_{CCL}$ ,  $I_{CCH}$ , and  $I_{CCZ}$ ).  
 $\Delta I_{CC}$  = Power Supply Current for a TTL-High Input ( $V_{IN} = V_{CC}-0.6V$ ).  
 $D_H$  = Duty Cycle for TTL High Inputs.  
 $N_T$  = Number of TTL High Inputs.  
 $I_{CCD}$  = Dynamic Current Caused by an Input Transition Pair (HLH or LHL).  
 $f$  = Average Switching Frequency per Output  
 $N_O$  = Number of Outputs Switching

**Table 8. Dynamic Switching Characteristics<sup>(1)</sup>**

| Symbol    | Parameter                            | Conditions                                     | $V_{CC}$<br>(V) | $T_A = 25^\circ C$ | Units |
|-----------|--------------------------------------|--|-----------------|--------------------|-------|
|           |                                      |  |                 | Typical            |       |
| $V_{OLP}$ | Quiet Output Dynamic Peak $V_{OL}$   | $C_L = 50pF$ , $V_{IH} = 3.3V$ , $V_{IL} = 0V$ | 3.3             | 0.8                | V     |
| $V_{OLV}$ | Quiet Output Dynamic Valley $V_{OL}$ | $C_L = 50pF$ , $V_{IH} = 3.3V$ , $V_{IL} = 0V$ | 3.3             | 0.8                | V     |

**Note:**

- Characterized but not production tested.

**Table 9. Switching Characteristics Over Operating Range**Industrial Temperature Range,  $T_A = -40^\circ\text{C}$  to  $+85^\circ\text{C}$ . $C_{\text{LOAD}} = 50\text{pF}$ ,  $R_{\text{LOAD}} = 500\Omega$  unless otherwise noted.

| Symbol                               | Description <sup>(1)</sup>  | 16245                                 |     |                                     |     | 16245C                                |     | Unit |
|--------------------------------------|---|---------------------------------------|-----|-------------------------------------|-----|---------------------------------------|-----|------|
|                                      |   | $V_{\text{CC}} = 3.3 \pm 0.3\text{V}$ |     | $V_{\text{CC}} = 2.7\text{V}^{(2)}$ |     | $V_{\text{CC}} = 3.3 \pm 0.3\text{V}$ |     |      |
|                                      |   | Min                                   | Max | Min                                 | Max | Min                                   | Max |      |
| $t_{\text{PHL}}$<br>$t_{\text{PLH}}$ | Propagation Delay<br>A to B, B to A                               | 1.5                                   | 4.5 | 1.5                                 | 5.2 | 1.5                                   | 4.1 | ns   |
| $t_{\text{PZH}}$<br>$t_{\text{PZL}}$ | Output Enable Time<br>$\overline{xOE}$ to A or B                  | 1.5                                   | 6.5 | 1.5                                 | 7.2 | 1.5                                   | 5.8 | ns   |
| $t_{\text{PHZ}}$<br>$t_{\text{PLZ}}$ | Output Disable Time <sup>(2)</sup><br>$\overline{xOE}$ to A or B  | 1.5                                   | 6.4 | 1.5                                 | 6.9 | 1.5                                   | 4.8 | ns   |
| $t_{\text{PZH}}$<br>$t_{\text{PZL}}$ | Output Enable Time <sup>(2)</sup><br>$\overline{xDIR}$ to A or B  | 1.5                                   | 6.5 | 1.5                                 | 7.2 | 1.5                                   | 5.8 | ns   |
| $t_{\text{PHZ}}$<br>$t_{\text{PLZ}}$ | Output Disable Time <sup>(2)</sup><br>$\overline{xDIR}$ to A or B | 1.5                                   | 6.4 | 1.5                                 | 6.9 | 1.5                                   | 4.8 | ns   |
| $t_{\text{SK}}(\text{O})$            | Output Skew <sup>(3)</sup>  | —                                     | 0.5 | —                                   | —   | —                                     | 0.5 | ns   |

**Notes:**

1. Minimums guaranteed but not tested. See Test Circuit and Waveforms.
2. Guaranteed by characterization.
3. Skew between any two outputs of the same package switching in the same direction. This parameter is guaranteed by characterization but not production tested.

TEST CIRCUIT AND WAVEFORMS

Figure 3. Test Circuit

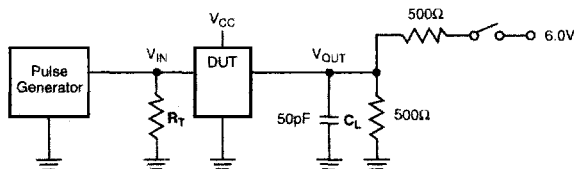

SWITCH POSITION

| Test             | Switch |
|------------------|--------|
| Open Drain       |        |
| Disable LOW      | 6V     |
| Enable LOW       |        |
| Disable HIGH     | GND    |
| Enable HIGH      |        |
| All Other Inputs | Open   |

DEFINITIONS:

$C_L$  = Load capacitance: includes jig and probe capacitance.  
 $R_T$  = Termination resistance: should be equal to  $Z_{OUT}$  of the Pulse generator.

Figure 4. Setup, Hold, and Release Timing

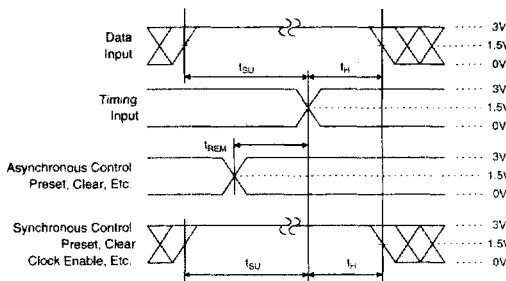

Figure 6. Pulse Width

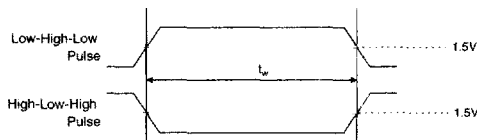

Figure 5. Enable and Disable Timing

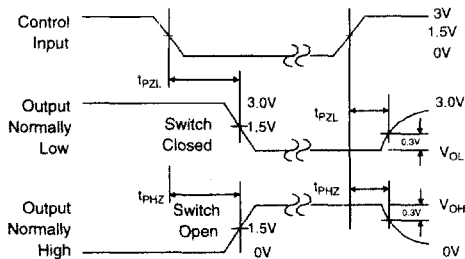
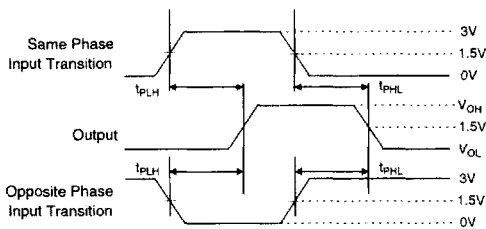

Figure 7. Propagation Delay



Notes:

1. Input Control Enable = LOW and input Control Disable = HIGH.
2. Pulse Generator for All Pulses: Rate  $\leq$  1.0MHz;  
 $Z_{OUT} \leq 50\Omega$ ;  $t_F$ ,  $t_R \leq 2.5ns$ .