

# Silicon carbide Power MOSFET 1200 V, 62 mΩ typ., 36 A in an HiP247 package

**HiP247**

AM01475v1\_noZen

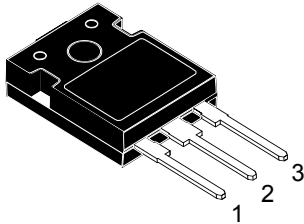
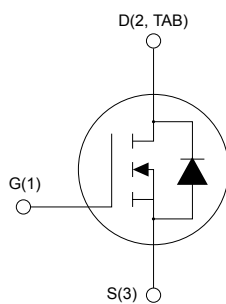

## Features

Order code	V <sub>DS</sub>	R <sub>DS(on)</sub> max.	I <sub>D</sub>
SCTW40N120G2V	1200 V	100 mΩ	36 A

- Very fast and robust intrinsic body diode
- Extremely low gate charge and input capacitance
- Very high operating junction temperature capability (T<sub>J</sub> = 200 °C)

## Applications

- Switching mode power supply
- DC-DC converters
- Industrial motor control

## Description

This silicon carbide Power MOSFET device has been developed using ST's advanced and innovative 2<sup>nd</sup> generation SiC MOSFET technology. The device features remarkably low on-resistance per unit area and very good switching performance. The variation of switching loss is almost independent of junction temperature.

### Product status link

[SCTW40N120G2V](#)

### Product summary

<b>Order code</b>	SCTW40N120G2V
<b>Marking</b>	SCT40N120G2V
<b>Package</b>	HiP247
<b>Packing</b>	Tube

# 1 Electrical ratings

**Table 1. Absolute maximum ratings**

Symbol	Parameter	Value	Unit
$V_{DS}$	Drain-source voltage	1200	V
$V_{GS}$	Gate-source voltage	-10 to 22	V
	Gate-source voltage (recommended operational values)	-5 to 18	
$I_D$	Drain current (continuous) at $T_C = 25\text{ °C}$	36	A
	Drain current (continuous) at $T_C = 100\text{ °C}$	27	
$I_{DM}^{(1)}$	Drain current (pulsed)	108	A
$P_{TOT}$	Total power dissipation at $T_C = 25\text{ °C}$	278	W
$T_{stg}$	Storage temperature range	-55 to 200	°C
$T_J$	Operating junction temperature range		°C

1. Pulse width is limited by safe operating area.

**Table 2. Thermal data**

Symbol	Parameter	Value	Unit
$R_{thJC}$	Thermal resistance, junction-to-case	0.63	°C/W
$R_{thJA}$	Thermal resistance, junction-to-ambient	40	°C/W

## 2 Electrical characteristics

( $T_C = 25\text{ °C}$  unless otherwise specified)

**Table 3. On/off states**

Symbol	Parameter	Test conditions	Min.	Typ.	Max.	Unit
$V_{(BR)DSS}$	Drain-source breakdown voltage	$V_{GS} = 0\text{ V}$ , $I_D = 1\text{ mA}$	1200			V
$I_{DSS}$	Zero gate voltage drain current	$V_{GS} = 0\text{ V}$ , $V_{DS} = 1200\text{ V}$			10	$\mu\text{A}$
$I_{GSS}$	Gate-body leakage current	$V_{DS} = 0\text{ V}$ , $V_{GS} = -10\text{ to }22\text{ V}$			$\pm 100$	nA
$V_{GS(th)}$	Gate threshold voltage	$V_{DS} = V_{GS}$ , $I_D = 1\text{ mA}$	1.90	2.45	4.90	V
$R_{DS(on)}$	Static drain-source on-resistance	$V_{GS} = 18\text{ V}$ , $I_D = 20\text{ A}$		62	100	m $\Omega$
		$V_{GS} = 18\text{ V}$ , $I_D = 20\text{ A}$ , $T_J = 200\text{ °C}$		137		

**Table 4. Dynamic**

Symbol	Parameter	Test conditions	Min.	Typ.	Max.	Unit
$C_{iss}$	Input capacitance	$V_{DS} = 800\text{ V}$ , $f = 1\text{ MHz}$ , $V_{GS} = 0\text{ V}$	-	1233	-	pF
$C_{oss}$	Output capacitance		-	56	-	pF
$C_{rss}$	Reverse transfer capacitance		-	15	-	pF
$R_G$	Intrinsic gate resistance	$f = 1\text{ MHz}$ , $I_D = 0\text{ A}$	-	1	-	$\Omega$
$Q_g$	Total gate charge	$V_{DD} = 800\text{ V}$ , $V_{GS} = -5\text{ to }18\text{ V}$ , $I_D = 20\text{ A}$	-	61	-	nC
$Q_{gs}$	Gate-source charge		-	13	-	nC
$Q_{gd}$	Gate-drain charge		-	25	-	nC

**Table 5. Switching energy (inductive load)**

Symbol	Parameter	Test conditions	Min.	Typ.	Max.	Unit
$E_{on}$	Turn-on switching energy	$V_{DD} = 800\text{ V}$ , $I_D = 20\text{ A}$ ,	-	243	-	$\mu\text{J}$
$E_{off}$	Turn-off switching energy	$R_G = 4.7\ \Omega$ , $V_{GS} = -5\text{ V to }18\text{ V}$	-	48	-	$\mu\text{J}$

**Table 6. Switching times**

Symbol	Parameter	Test conditions	Min.	Typ.	Max.	Unit
$t_{d(on)}$	Turn-on delay time	$V_{DD} = 800\text{ V}$ , $I_D = 20\text{ A}$ , $R_G = 4.7\ \Omega$ , $V_{GS} = -5\text{ to }18\text{ V}$	-	13.4	-	ns
$t_r$	Rise time		-	10.3	-	ns
$t_{d(off)}$	Turn-off delay time		-	22	-	ns
$t_f$	Fall time		-	7.9	-	ns

**Table 7. Reverse SiC diode characteristics**

Symbol	Parameter	Test conditions	Min.	Typ.	Max.	Unit
$V_{SD}$	Diode forward voltage	$I_{SD} = 20\text{ A}$ , $V_{GS} = 0\text{ V}$	-	3.3	-	V
$t_{rr}$	Reverse recovery time	$I_{SD} = 20\text{ A}$ , $di/dt = 2000\text{ A}/\mu\text{s}$ , $V_{DD} = 800\text{ V}$ , $V_{GS} = -5\text{ to }18\text{ V}$	-	15	-	ns
$Q_{rr}$	Reverse recovery charge		-	77	-	nC
$I_{RRM}$	Reverse recovery current		-	9	-	A

## 2.1 Electrical characteristics (curves)

Figure 1. Safe operating area

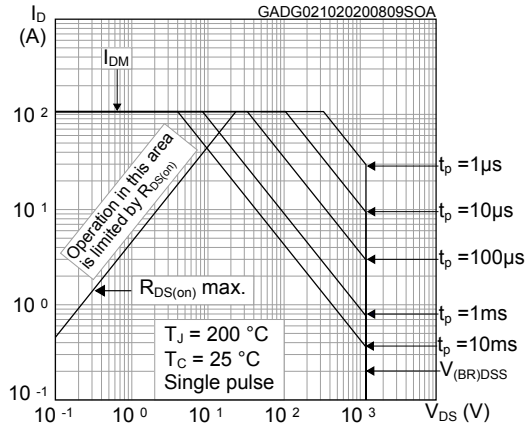

Figure 2. Maximum transient thermal impedance

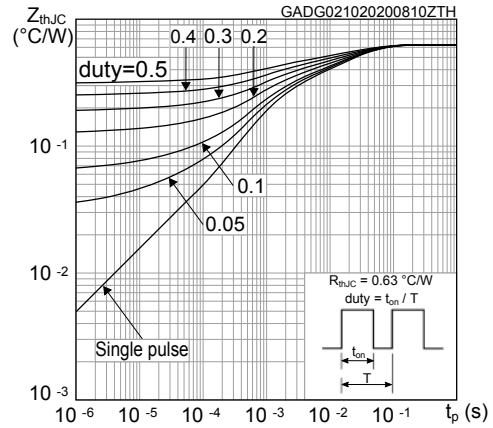

Figure 3. Typical output characteristics ( $T_J = 25^\circ\text{C}$ )

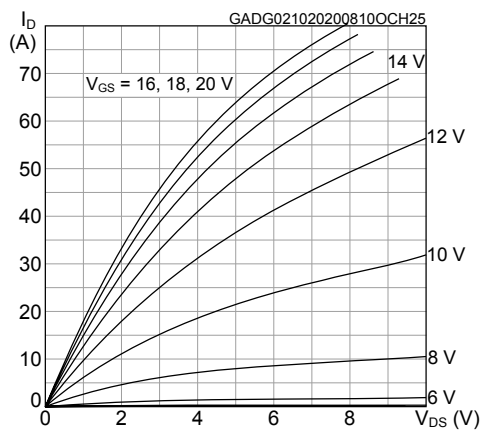

Figure 4. Typical output characteristics ( $T_J = 200^\circ\text{C}$ )

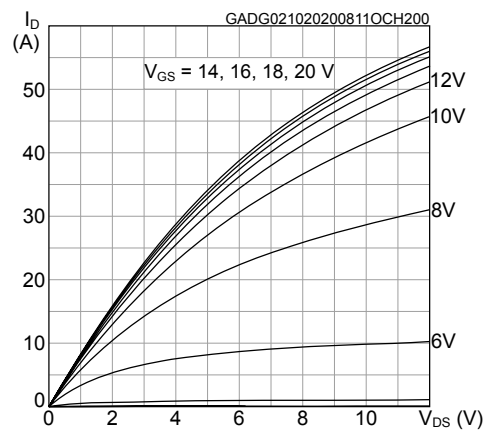

Figure 5. Typical transfer characteristics

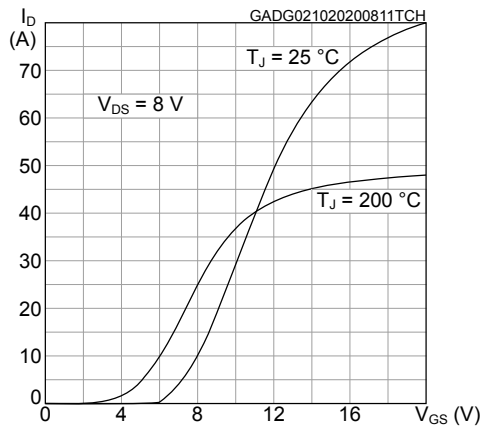

Figure 6. Total power dissipation

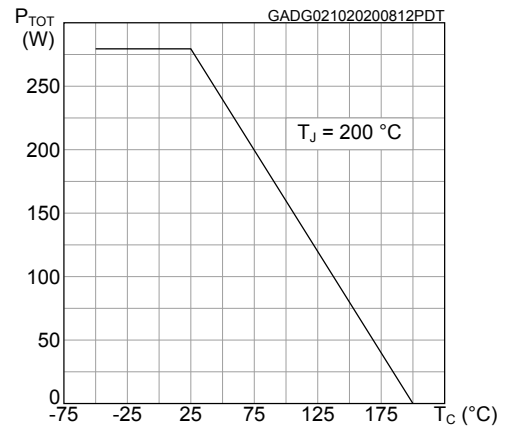

Figure 7. Typical gate charge characteristics

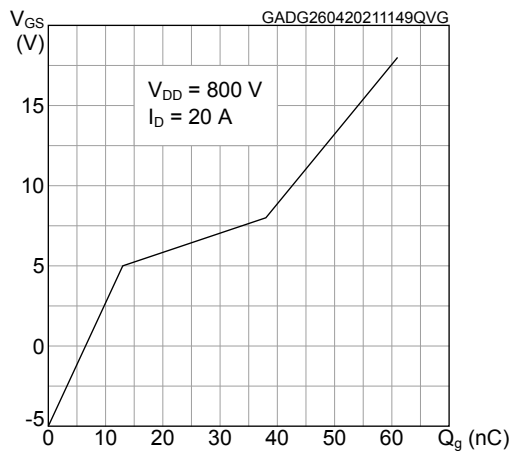

Figure 8. Typical capacitance characteristics

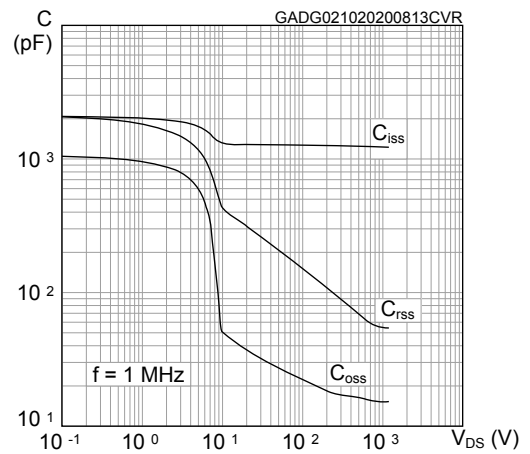

Figure 9. Typical switching energy vs drain current

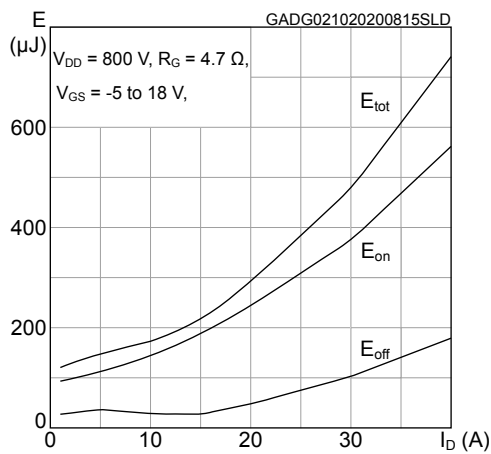

Figure 10. Typical switching energy vs junction temperature

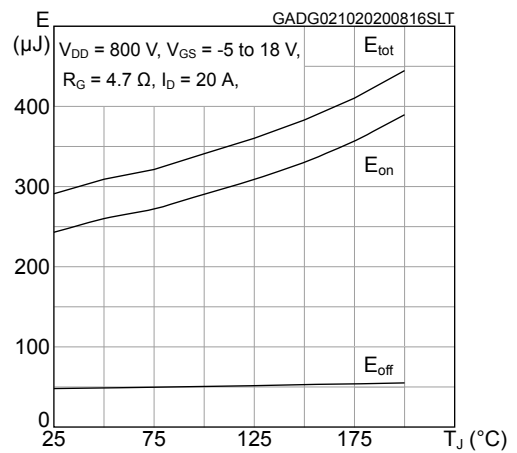

Figure 11. Normalized breakdown voltage vs temperature

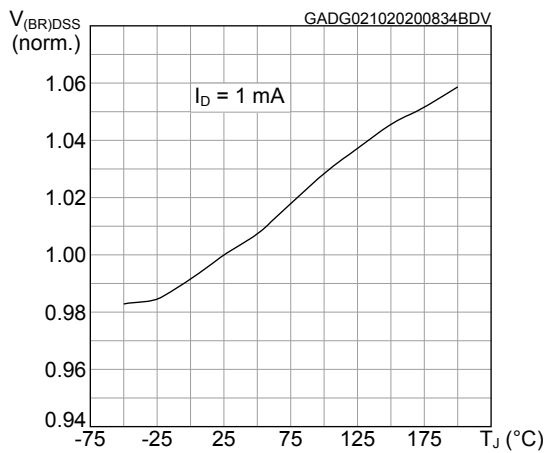

Figure 12. Normalized gate threshold vs temperature

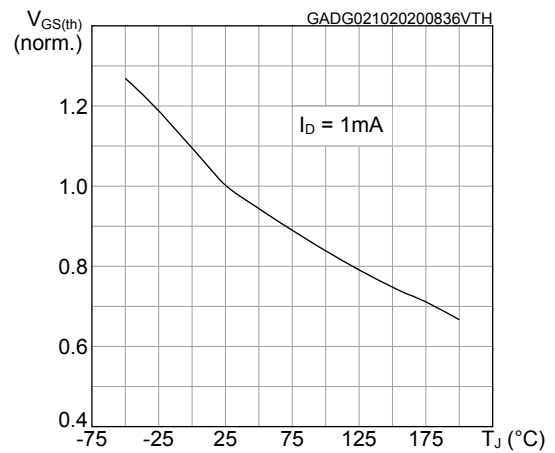

Figure 13. Normalized on-resistance vs temperature

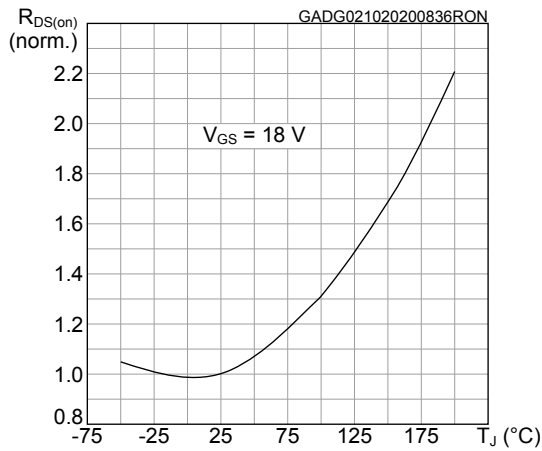

Figure 14. Typical reverse conduction characteristics ( $T_J = 25$  °C)

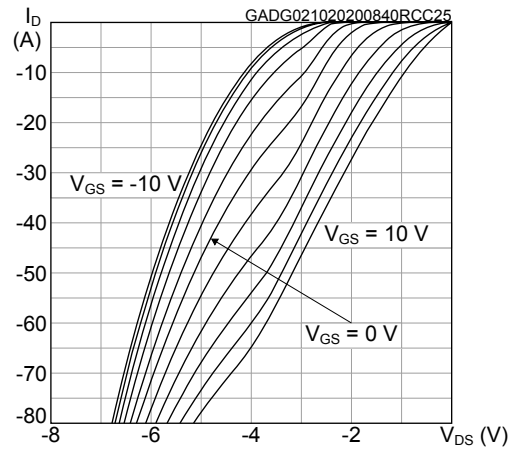

Figure 15. Typical reverse conduction characteristics ( $T_J = 200$  °C)

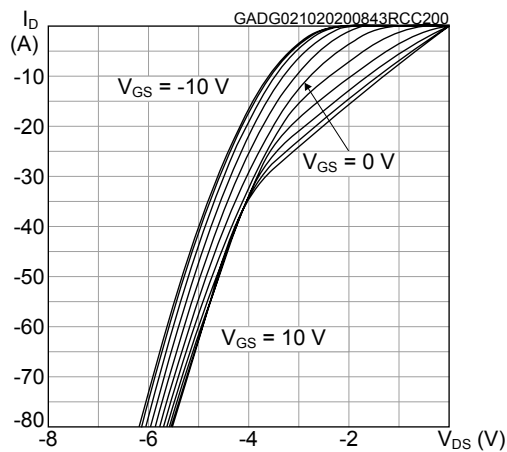
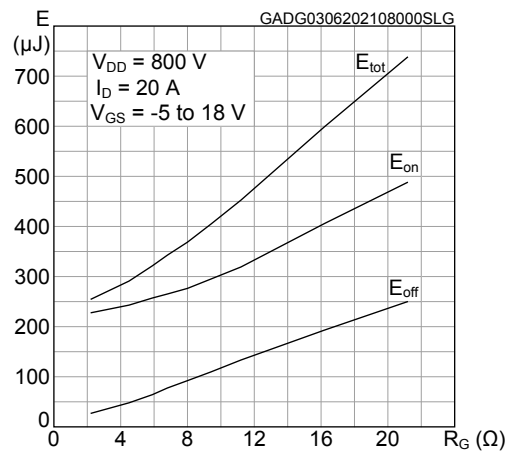

Figure 16. Typical switching energy vs gate resistance



### 3 Package information

In order to meet environmental requirements, ST offers these devices in different grades of **ECOPACK** packages, depending on their level of environmental compliance. ECOPACK specifications, grade definitions and product status are available at: [www.st.com](http://www.st.com). ECOPACK is an ST trademark.

#### 3.1 HiP247 package information

Figure 17. HiP247 package outline

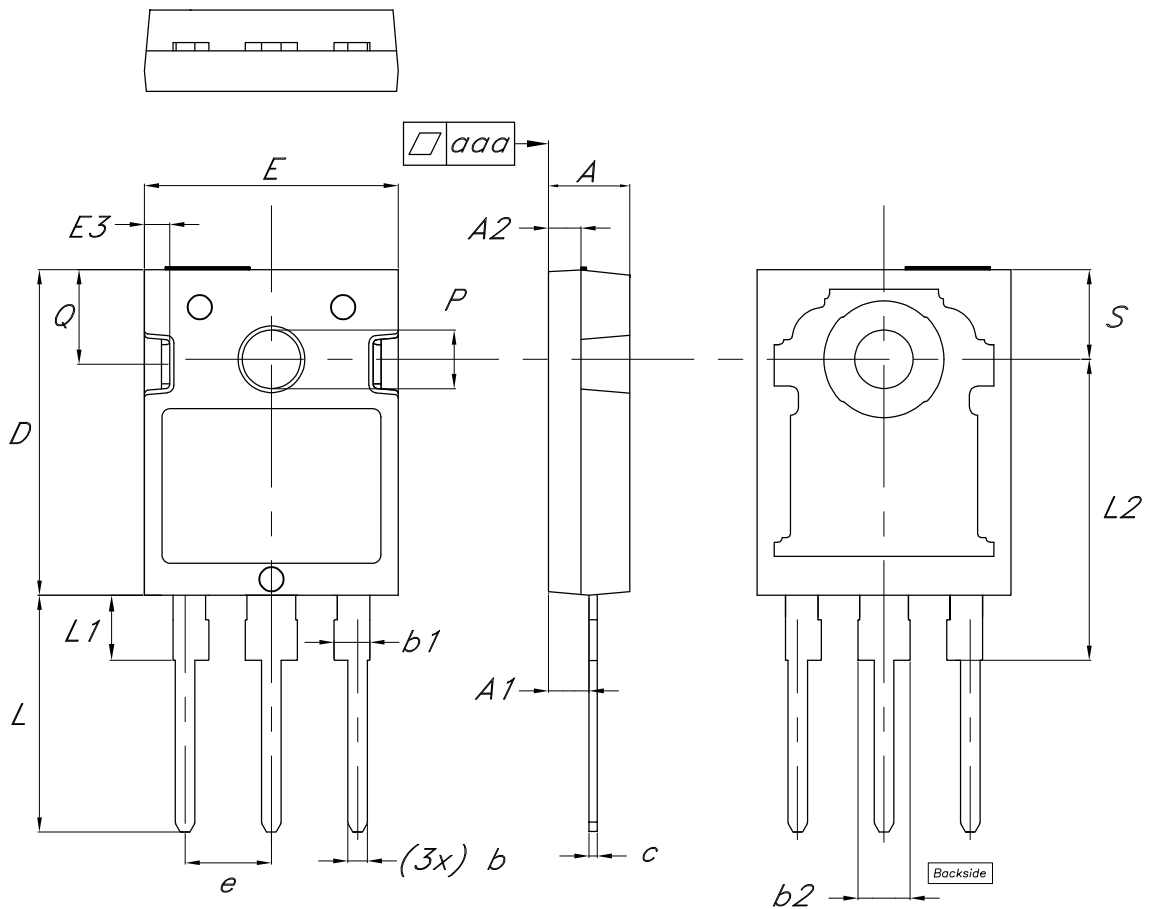

8581091\_4



**Table 8. HiP247 package mechanical data**

Dim.	mm		
	Min.	Typ.	Max.
A	4.85	5.00	5.15
A1	2.20		2.60
A2	1.90	2.00	2.10
b	1.00		1.40
b1	2.00		2.40
b2	3.00		3.40
c	0.40		0.80
D	19.85	20.00	20.15
E	15.45	15.60	15.75
E3	1.45		1.65
e	5.30	5.45	5.60
L	14.20		14.80
L1	3.70		4.30
L2	18.30	18.50	18.70
P	3.55		3.65
Q	5.65		5.95
S	5.30	5.50	5.70
aaa		0.04	0.10

## Revision history

**Table 9. Document revision history**

Date	Version	Changes
08-Oct-2020	1	First release.
09-Jun-2021	2	Modified title, $R_{DS(on)}$ value, applications and description on cover page. Modified <a href="#">Table 2. Thermal data</a> and <a href="#">Table 3. On/off states</a> . Modified <a href="#">Section 2.1 Electrical characteristics (curves)</a> . Minor text changes.

---

## Contents

<b>1</b>	<b>Electrical ratings</b> .....	<b>2</b>
<b>2</b>	<b>Electrical characteristics</b> .....	<b>3</b>
<b>2.1</b>	Electrical characteristics (curves) .....	<b>5</b>
<b>3</b>	<b>Package information</b> .....	<b>8</b>
<b>3.1</b>	HiP247 package information .....	<b>8</b>
	<b>Revision history</b> .....	<b>10</b>

**IMPORTANT NOTICE – PLEASE READ CAREFULLY**

STMicroelectronics NV and its subsidiaries (“ST”) reserve the right to make changes, corrections, enhancements, modifications, and improvements to ST products and/or to this document at any time without notice. Purchasers should obtain the latest relevant information on ST products before placing orders. ST products are sold pursuant to ST’s terms and conditions of sale in place at the time of order acknowledgement.

Purchasers are solely responsible for the choice, selection, and use of ST products and ST assumes no liability for application assistance or the design of Purchasers’ products.

No license, express or implied, to any intellectual property right is granted by ST herein.

Resale of ST products with provisions different from the information set forth herein shall void any warranty granted by ST for such product.

ST and the ST logo are trademarks of ST. For additional information about ST trademarks, please refer to [www.st.com/trademarks](http://www.st.com/trademarks). All other product or service names are the property of their respective owners.

Information in this document supersedes and replaces information previously supplied in any prior versions of this document.

© 2021 STMicroelectronics – All rights reserved