

# G3VM-355CR/FR

MOS FET Relays

## SPST-NO + SPST-NC MOS FET Relay in a Single DIP Package.

• SPST-NO/SPST-NC models now included in the 350-V load voltage series.

RoHS compliant

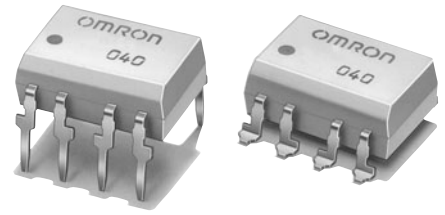

Note: The actual product is marked differently from the image shown here.

### Application Examples

- Test & Measurement equipment
- Security systems
- Amusement machines

### Terminal Arrangement/Internal Connections

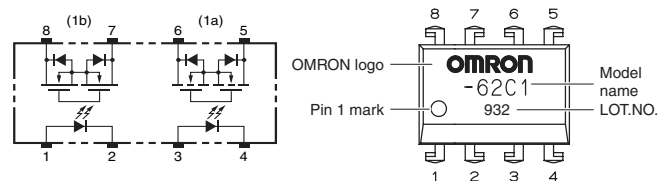

Note: The actual product is marked differently from the image shown here.

### List of Models

Package type	Contact form	Terminals	Load voltage (peak value) *	Model	Minimum package quantity	
					Number per tube	Number per tape and reel
DIP8	1a1b (SPST-NO/SPST-NC)	PCB Terminals	350 V	G3VM-355CR	50	-
		Surface-mounting Terminals		G3VM-355FR		
				G3VM-355FR (TR)	-	1,500

\* The AC peak and DC value are given for the load voltage.

### Absolute Maximum Ratings (Ta = 25°C)

Item		Symbol	Rating	Unit	Measurement conditions
Input	LED forward current	IF	50	mA	
	Repetitive peak LED forward current	IFP	1	A	100 μs pulses, 100 pps
	LED forward current reduction rate	ΔIF/°C	-0.5	mA/°C	Ta ≥ 25°C
Output	LED reverse voltage	VR	5	V	
	Connection temperature	TJ	125	°C	
	Load voltage (AC peak/DC)	V <sub>OFF</sub>	350	V	
	Continuous load current (AC peak/DC)	Io	120	mA	
	ON current reduction rate	ΔIo/°C	-1.2	mA/°C	Ta ≥ 25°C
	Connection temperature	TJ	125	°C	
	Dielectric strength between I/O (See note 1.)	V <sub>I-O</sub>	2500	Vrms	AC for 1 min
Ambient operating temperature	Ta	-40 to +85	°C	With no icing or condensation	
Ambient storage temperature	Tstg	-55 to +125	°C	With no icing or condensation	
Soldering temperature	-	260	°C	10 s	

Note: 1. The dielectric strength between the input and output was checked by applying voltage between all pins as a group on the LED side and all pins as a group on the light-receiving side.

### Electrical Characteristics (Ta = 25°C)

Item		Symbol	Minimum	Typical	Maximum	Unit	Measurement conditions
Input	LED forward voltage	V <sub>F</sub>	1.0	1.15	1.3	V	IF = 10 mA
	Reverse current	I <sub>R</sub>	-	-	10	μA	VR = 5 V
	Capacity between terminals	C <sub>T</sub>	-	30	-	pF	V = 0, f = 1 MHz
Trigger LED forward current	1a : I <sub>FT</sub>	-	-	1	3	mA	1a : Io = 120 mA
	1b : I <sub>FC</sub>	-	-	-	-	-	1b : I <sub>OFF</sub> = 10 μA
Output	Maximum resistance with output ON	R <sub>ON</sub>	-	15	25	Ω	1a : IF = 5 mA, Io = 120 mA 1b : IF = 0 mA, Io = 120 mA
	Current leakage when the relay is open	I <sub>LEAK</sub>	-	-	1.0	μA	V <sub>OFF</sub> = 350 V
	Capacity between terminals	C <sub>OFF</sub>	-	65	-	pF	(1a) V = 0, f = 1 MHz (1b) V = 0, f = 1 MHz, IF = 5 mA
Capacity between I/O terminals	C <sub>I-O</sub>	-	0.8	-	pF	f = 1 MHz, Vs = 0 V	
Insulation resistance between I/O terminals	R <sub>I-O</sub>	1000	-	-	MΩ	V <sub>I-O</sub> = 500 VDC, RoH ≤ 60%	
Turn-ON time	1a	t <sub>ON</sub>	-	-	1.0	ms	IF = 5 mA, RL = 200 Ω, VDD = 20 V (See note 2.)
	1b	t <sub>ON</sub>	-	-	1.0	ms	
Turn-OFF time	1a	t <sub>OFF</sub>	-	-	1.0	ms	
	1b	t <sub>OFF</sub>	-	-	3.0	ms	

Note: 2. Turn-ON and Turn-OFF Times

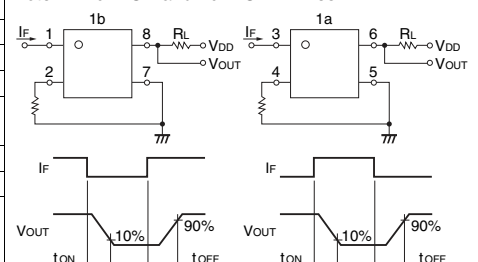

## Recommended Operating Conditions

Use the G3VM under the following conditions so that the Relay will operate properly.

Item	Symbol	Minimum	Typical	Maximum	Unit
Load voltage (AC peak/DC)	$V_{DD}$	-	-	280	V
Operating LED forward current	$I_F$	5	-	25	mA
Continuous load current (AC peak/DC)	$I_O$	-	-	120	mA
Ambient operating temperature	$T_a$	-20	-	65	°C

## Engineering Data

(Common to SPST-NO and SPST-NC contacts)

LED forward current vs. Ambient temperature

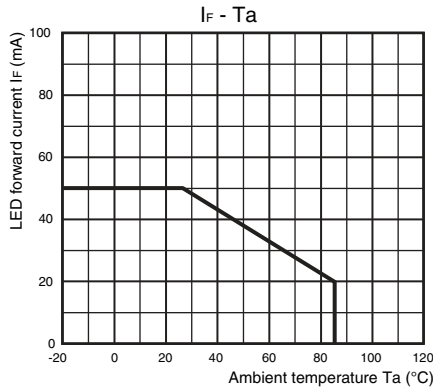

Continuous load current vs. Ambient temperature

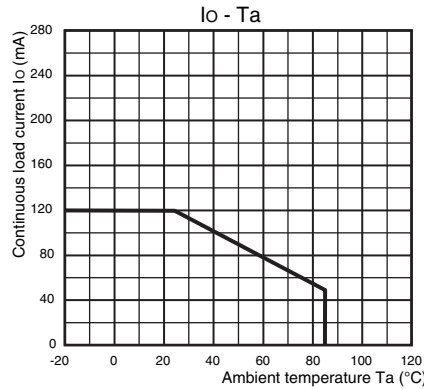

LED forward current vs. LED forward voltage

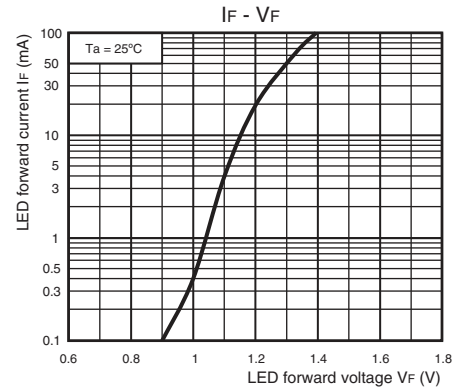

(SPST-NO contacts)

Continuous load current vs. On-state voltage

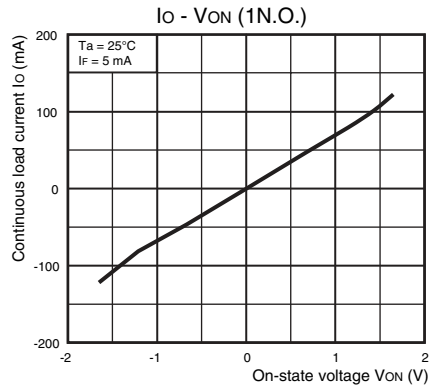

On-state resistance vs. Ambient temperature

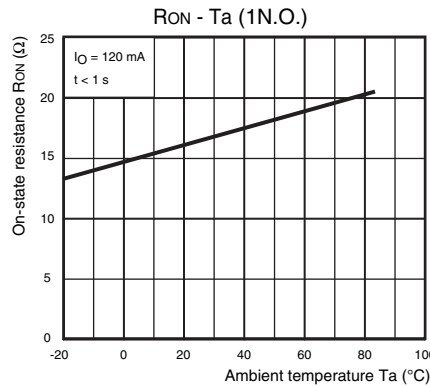

Trigger LED forward current vs. Ambient temperature

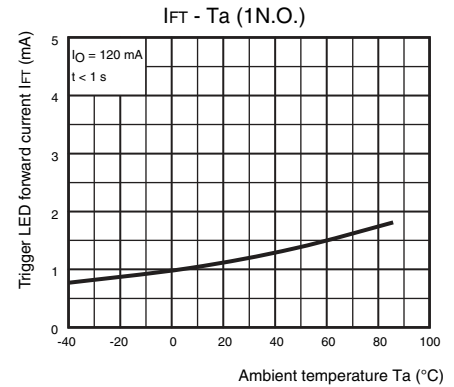

Turn ON, Turn OFF time vs. LED forward current

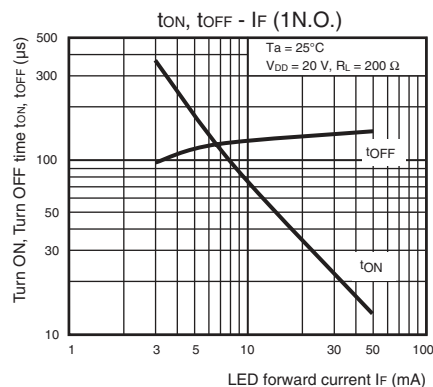

Turn ON, Turn OFF time vs. Ambient temperature

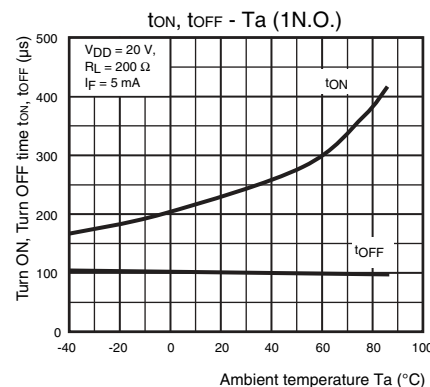

Current leakage vs. Ambient temperature

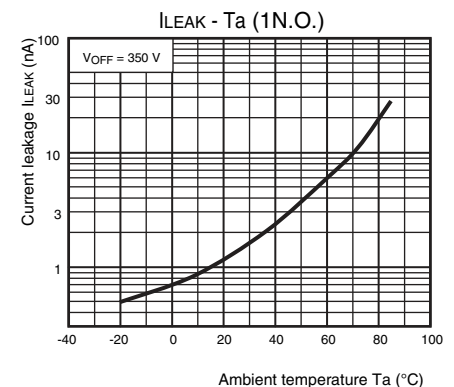

(SPST-NC contacts)

**Continuous load current vs. On-state voltage**

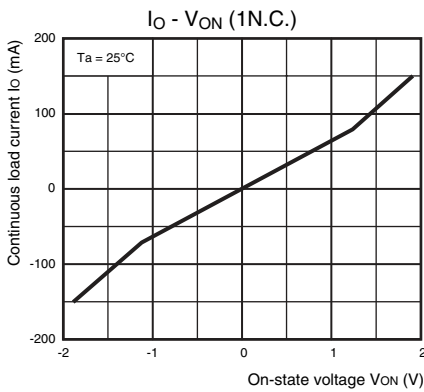

**On-state resistance vs. Ambient temperature**

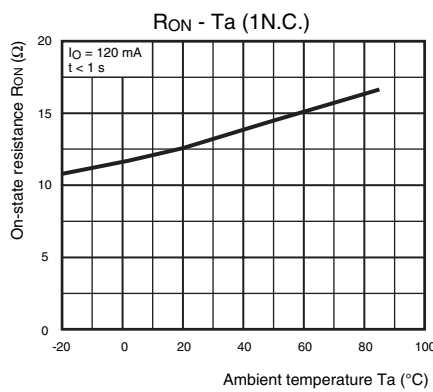

**Trigger LED forward current vs. Ambient temperature**

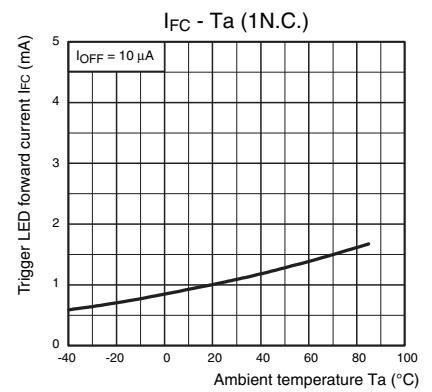

**Turn ON, Turn OFF time vs. LED forward current**

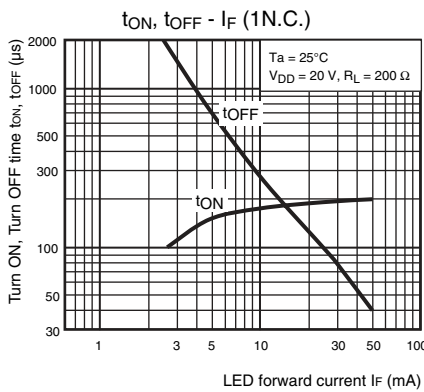

**Turn ON, Turn OFF time vs. Ambient temperature**

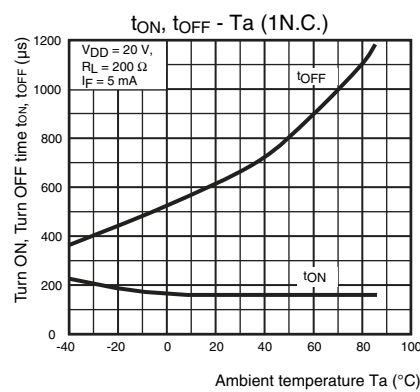

**Current leakage vs. Ambient temperature**

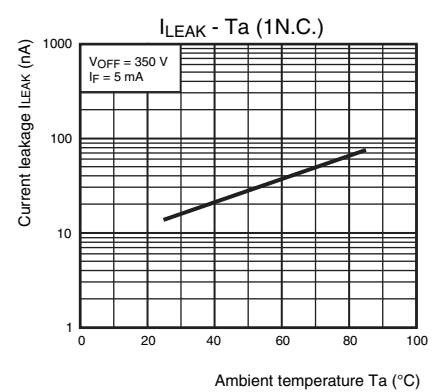

### ■ Safety Precautions

- Refer to "Common Precautions" for all G3VM models.

## ■ Appearance

### DIP (Dual Inline Package) DIP8

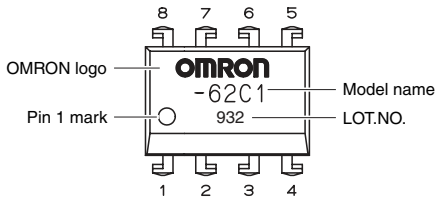

Note: The actual product is marked differently from the image shown here.

## ■ Dimensions

(Unit: mm)

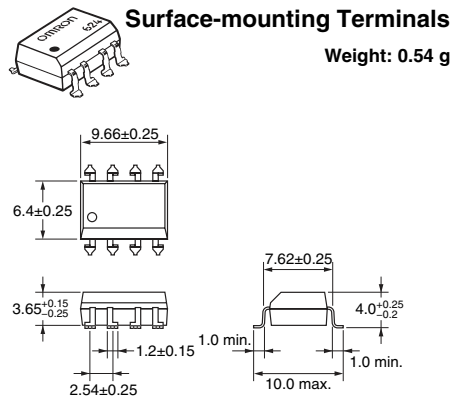
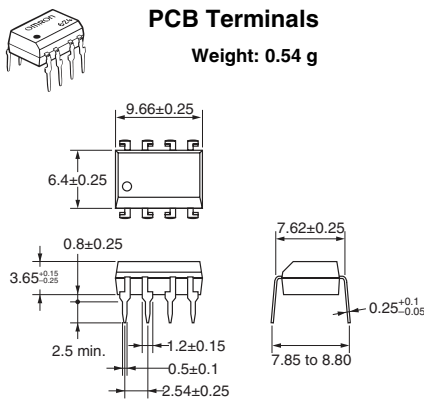

### PCB Dimensions (BOTTOM VIEW)

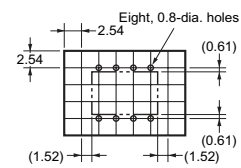

### Actual Mounting Pad Dimensions

(Recommended Value, TOP VIEW)

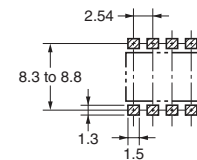

Note: The actual product is marked differently from the image shown here.

- Application examples provided in this document are for reference only. In actual applications, confirm equipment functions and safety before using the product.
- Consult your OMRON representative before using the product under conditions which are not described in the manual or applying the product to nuclear control systems, railroad systems, aviation systems, vehicles, combustion systems, medical equipment, amusement machines, safety equipment, and other systems or equipment that may have a serious influence on lives and property if used improperly. Make sure that the ratings and performance characteristics of the product provide a margin of safety for the system or equipment, and be sure to provide the system or equipment with double safety mechanisms.

Note: Do not use this document to operate the Unit.