

## OMNIMATE Power - series LU LUF 10.00/08/90 5.0SN BK BX

**Weidmüller Interface GmbH & Co. KG**  
Klingenbergstraße 16  
D-32758 Detmold  
Germany  
Fon: +49 5231 14-0  
Fax: +49 5231 14-292083  
www.weidmueller.com

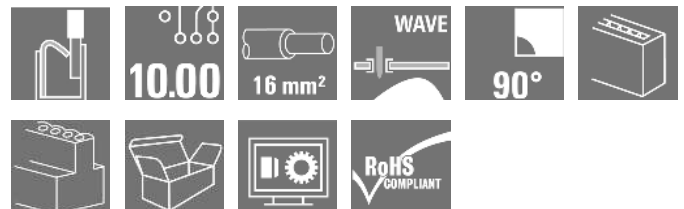

**The sturdy, direct connection for extreme current and voltage requirements in all power electronics applications such as solar inverters, frequency converters, servo-controllers and power supplies.**

### General ordering data

Type	LUF 10.00/08/90 5.0SN BK BX
Order No.	<a href="#">1988660000</a>
Version	PCB terminal, 10.00 mm, No. of poles: 8, 90°, Solder pin length (l): 5 mm, Black, PUSH IN with actuator, Clamping range, max. : 16 mm², Box
GTIN (EAN)	4050118373264
Qty.	10 pc(s).
Product data	IEC: 1000 V / 76 A / 0.5 - 16 mm² UL: 300 V / 61 A / AWG 18 - AWG 6
Packaging	Box

**OMNIMATE Power - series LU**  
**LUF 10.00/08/90 5.0SN BK BX**

**Weidmüller Interface GmbH & Co. KG**  
 Klingenbergstraße 16  
 D-32758 Detmold  
 Germany  
 Fon: +49 5231 14-0  
 Fax: +49 5231 14-292083  
 www.weidmueller.com

**Technical data****Dimensions and weights**

Width	81.58 mm	Width (inches)	3.212 inch
Height	47.03 mm	Height (inches)	1.852 inch
Height of lowest version	42.03 mm	Depth	26.45 mm
Depth (inches)	1.041 inch	Net weight	81.478 g

**System parameters**

Product family	OMNIMATE Power - series LU	Wire connection method	PUSH IN with actuator
Mounting onto the PCB	THT solder connection	Conductor outlet direction	90°
Pitch in mm (P)	10 mm	Pitch in inches (P)	0.394 inch
No. of poles	8	Fitted by customer	No
Solder pin length (l)	5 mm	Solder pin dimensions	d = 1.2 mm, Octagonal
Solder eyelet hole diameter (D)	1.6 mm	Solder eyelet hole diameter tolerance (D)	+ 0,1 mm
Number of solder pins per pole	6	Screwdriver blade	0.8 x 4.0
Stripping length	18 mm	L1 in mm	70 mm
L1 in inches	2.756 inch	Touch-safe protection acc. to DIN VDE 0470	IP20 plugged/ IP10 unplugged
Touch-safe protection acc. to DIN VDE 57 106	touch-safe with connected connectors from 6 mm <sup>2</sup>		

**Material data**

Insulating material	Wemid (PA)	Colour	Black
Colour chart (similar)	RAL 9011	Insulating material group	I
CTI	≥ 600	Insulation resistance	≥ 10 <sup>8</sup> Ω
UL 94 flammability rating	V-0	Contact base material	E-Cu
Layer structure of solder connection	4-6 μm Sn matt	Storage temperature, min.	-25 °C
Storage temperature, max.	55 °C	Max. relative humidity during storage	80 %
Operating temperature, min.	-40 °C	Operating temperature, max.	120 °C

**Conductors suitable for connection**

Clamping range, min.	0.5 mm <sup>2</sup>	Clamping range, max.	16 mm <sup>2</sup>
Wire connection cross section AWG, min.	AWG 20	Wire connection cross section AWG, max.	AWG 4
Solid, min. H05(07) V-U	0.5 mm <sup>2</sup>	Solid, max. H05(07) V-U	16 mm <sup>2</sup>
Stranded, min. H07V-R	6 mm <sup>2</sup>	Stranded, max. H07V-R	16 mm <sup>2</sup>
Flexible, min. H05(07) V-K	0.5 mm <sup>2</sup>	Flexible, max. H05(07) V-K	16 mm <sup>2</sup>
w. plastic collar ferrule, DIN 46228 pt 4, min.	0.5 mm <sup>2</sup>	w. plastic collar ferrule, DIN 46228 pt 4, max.	16 mm <sup>2</sup>
w. wire end ferrule, DIN 46228 pt 1, min.	0.5 mm <sup>2</sup>	w. wire end ferrule, DIN 46228 pt 1, max.	16 mm <sup>2</sup>
Plug gauge acc. to EN 60999 a x b; Ø	5.3mm (B6)		

**OMNIMATE Power - series LU**  
**LUF 10.00/08/90 5.0SN BK BX**

**Weidmüller Interface GmbH & Co. KG**  
Klingenbergstraße 16  
D-32758 Detmold  
Germany  
Fon: +49 5231 14-0  
Fax: +49 5231 14-292083  
www.weidmueller.com

**Technical data**

**Rated data acc. to IEC**

tested acc. to standard	IEC 60947-7-4	Rated current, min. no. of poles (Tu=20°C)	76 A
Rated current, max. no. of poles (Tu=20°C)	76 A	Rated current, min. no. of poles (Tu=40°C)	76 A
Rated current, max. no. of poles (Tu=40°C)	76 A	Rated voltage for surge voltage class / pollution degree II/2	1,000 V
Rated voltage for surge voltage class / pollution degree III/2	690 V	Rated voltage for surge voltage class / pollution degree III/3	630 V
Rated impulse voltage for surge voltage class/ pollution degree II/2	6 kV	Rated impulse voltage for surge voltage class/ pollution degree III/2	6 kV
Rated impulse voltage for surge voltage class/ contamination degree III/3	6 kV		

**Rated data acc. to CSA**

Rated voltage (Use group B)	300 V	Rated voltage (Use group C)	150 V
Rated voltage (use group D)	600 V	Rated current (use group B)	61 A
Rated current (use group C)	61 A	Rated current (use group D)	5 A
Wire cross-section, AWG, min.	AWG 18	Wire cross-section, AWG, max.	AWG 6

**Rated data acc. to UL 1059**

Institute (cURus)		Certificate No. (cURus)	E60693
Rated voltage (use group B)	300 V	Rated voltage (use group C)	1,000 V
Rated voltage (use group D)	600 V	Rated current (use group B)	61 A
Rated current (use group C)	61 A	Rated current (use group D)	5 A
Wire cross-section, AWG, min.	AWG 18	Wire cross-section, AWG, max.	AWG 6
Reference to approval values	Specifications are maximum values, details - see approval certificate.		

**Packaging**

Packaging	Box	Packaging unit (VPE) length	0 MTR
Packaging unit (VPE) width	0 MTR	Packaging unit (VPE) height	0 MTR

**Classifications**

ETIM 3.0	EC001284	ETIM 4.0	EC002643
ETIM 5.0	EC002643	ETIM 6.0	EC002643
eClass 6.2	27-26-11-01	eClass 9.1	27-44-04-01

## Data sheet

### OMNIMATE Power - series LU LUF 10.00/08/90 5.0SN BK BX

**Weidmüller Interface GmbH & Co. KG**  
Klingenbergstraße 16  
D-32758 Detmold  
Germany  
Fon: +49 5231 14-0  
Fax: +49 5231 14-292083  
www.weidmueller.com

## Technical data

### Notes

Notes	<ul style="list-style-type: none"> <li>• Additional colours on request</li> <li>• Rated current related to rated cross-section &amp; min. No. of poles.</li> <li>• Wire end ferrule without plastic collar to DIN 46228/1</li> <li>• Wire end ferrule with plastic collar to DIN 46228/4</li> <li>• P on drawing = pitch</li> <li>• Rated data refer only to the component itself. Clearance and creepage distances to other components are to be designed in accordance with the relevant application standards.</li> <li>• The test point can only be used as potential-pickup point.</li> </ul>
IPC conformity	Conformity: The products are developed, manufactured and delivered according international recognized standards and norms and comply with the assured properties in the data sheet resp. fulfill decorative properties in accordance with IPC-A-610 "Class 2". Further claims on the products can be evaluated on request.

### Approvals

Approvals



ROHS

Conform

### Downloads

Approval/Certificate/Document of Conformity	<a href="#">Declaration of the Manufacturer</a>
Brochure/Catalogue	<a href="#">FL DRIVES EN</a> <a href="#">MB DEVICE MANUF. EN</a> <a href="#">FL DRIVES DE</a> <a href="#">FL APPL_INVERTER EN</a> <a href="#">FL_BASE_STATION_EN</a> <a href="#">FL ELEVATOR EN</a> <a href="#">FL POWER SUPPLY EN</a> <a href="#">FL 72H SAMPLE SER EN</a> <a href="#">PO OMNIMATE EN</a>
Engineering Data	<a href="#">EPLAN, WSCAD</a>
Engineering Data	<a href="#">STEP</a>
Motion controllers white paper	<a href="#">Download Whitepaper</a>
White Paper UL 600 V	<a href="#">Download Whitepaper</a>

**OMNIMATE Power - series LU**  
**LUF 10.00/08/90 5.0SN BK BX**

**Weidmüller Interface GmbH & Co. KG**  
 Klingenbergstraße 16  
 D-32758 Detmold  
 Germany  
 Fon: +49 5231 14-0  
 Fax: +49 5231 14-292083  
 www.weidmueller.com

**Drawings**

**Dimensional drawing**

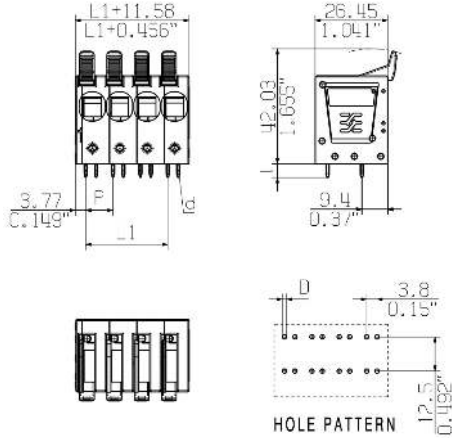

**Derating curve**

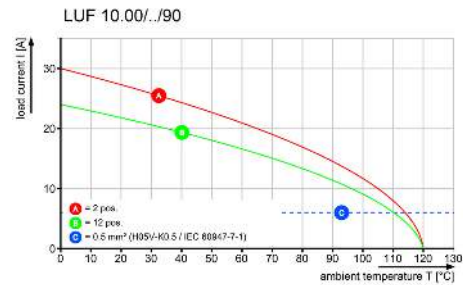

**Derating curve**

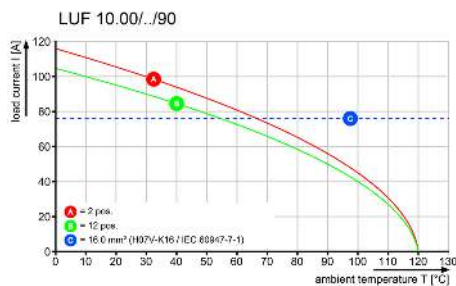

## Recommended wave soldering profiles

**Weidmüller Interface GmbH & Co. KG**  
 Klängenbergstraße 16  
 D-32758 Detmold  
 Germany  
 Fon: +49 5231 14-0  
 Fax: +49 5231 14-292083  
 www.weidmueller.com

### Single Wave:

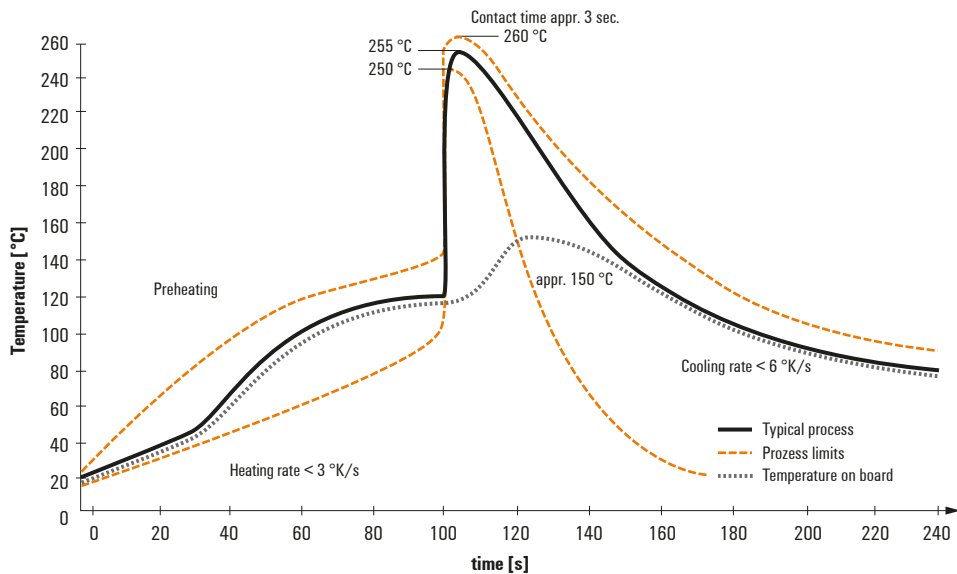

### Double Wave:

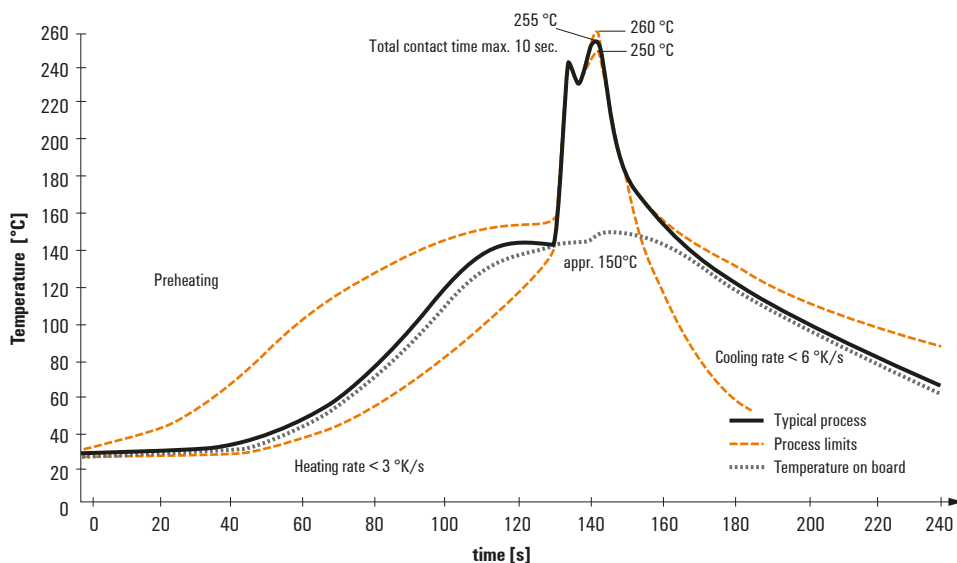

### Wave soldering profiles

Wired connection elements should be processed in accordance with the DIN EN 61760-1 standard. We have included two recommendations for practical wave soldering profiles, with which Weidmüller PCB terminals and connectors are qualified.

When choosing a suitable profile for your application, the following factors also need to be considered:

- PCB thickness
- Proportion of Cu in the layers
- Single/double-sided assembly
- Product range
- Heating and cooling rates

The single and double wave profiles each indicate the recommended operating range, including the maximum soldering temperature of 260°C. In practice, the maximum soldering temperature is quite often well below the above maximum profile.