

May 1990

Operational Amplifiers

For Commercial, Industrial, and Military Applications

Features:

- Short-circuit protection and latch-free operation
- Unity-gain phase compensation with a single 30-pF capacitor
- Replacement for industry types 101, 201, 301A
- CA301A Slew Rate (Summing ampl.) 10 V/μs

Applications:

- Long-interval integrator
- Timers
- Sample-and-hold circuits
- Summing amplifiers
- Multivibrators
- Comparators
- Instrumentation
- AC/DC converters
- Inverting amplifiers
- Sine- & square-wave generators
- Capacitance multipliers & simulated inductors

The CA101, CA201, and CA301A are general-purpose, high-gain operational amplifiers for use in military, industrial, and commercial applications.

These types, which are externally phase compensated, permit a choice of operation for optimum high-frequency performance at a selected gain; unity-gain compensation can be obtained with a single 30-pF capacitor.

All types are available in 8-lead TO-5 style packages with standard leads (T suffix), and with dual-in-line formed leads ("DIL-CAN", S suffix). The CA301A is also available in the 8-lead dual-in-line plastic package ("MINI-DIP", E suffix), and in chip form (H suffix).

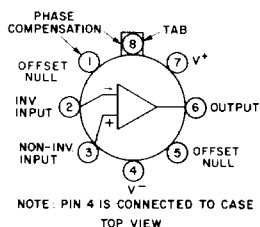

(a) TO-5 Style package for all types
T-Suffix
S-Suffix

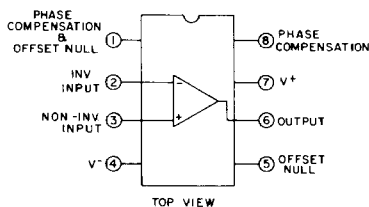

(b) Plastic package for CA301A
E-Suffix

Figure 1 - Functional diagrams.

*Technical Data on LM Branded types is identical to the corresponding CA Branded types.

CA101, CA201, CA301A, LM201, LM301A

Maximum Ratings, Absolute Maximum Values at $T_A = 25^\circ\text{C}$:

DC SUPPLY VOLTAGE (Between V_+ and V_- Terminals):

CA101, CA201	44 V
CA301A	36 V

DC INPUT VOLTAGE

$\pm 15\text{ V}$
(For supply voltages less than $\pm 15\text{ V}$, the Input Voltage rating is equal to the DC Supply Voltage)

DIFFERENTIAL INPUT VOLTAGE

$\pm 30\text{ V}$

OUTPUT SHORT-CIRCUIT DURATION

Indefinite*

DEVICE DISSIPATION:

UP TO $T_A = 75^\circ\text{C}$ 500 mW

Above $T_A = 75^\circ\text{C}$ Derate linearly at 6.67 mW/ $^\circ\text{C}$

AMBIENT TEMPERATURE RANGE:

Operating —

CA101 -55 to $+125^\circ\text{C}$

CA201, CA301A 0 to $+70^\circ\text{C}$

Storage (All types) -65 to $+150^\circ\text{C}$

LEAD TEMPERATURE (During Soldering):

At a distance $1/16'' \pm 1/32''$ ($1.59 \pm 0.79\text{ mm}$) from case for 10 seconds max. $+265^\circ\text{C}$

* At $T_A \leq 70^\circ\text{C}$ and $T_c \leq 125^\circ\text{C}$ (CA101); $T_A \leq 55^\circ\text{C}$ and $T_c \leq 70^\circ\text{C}$ (CA201, CA301A).

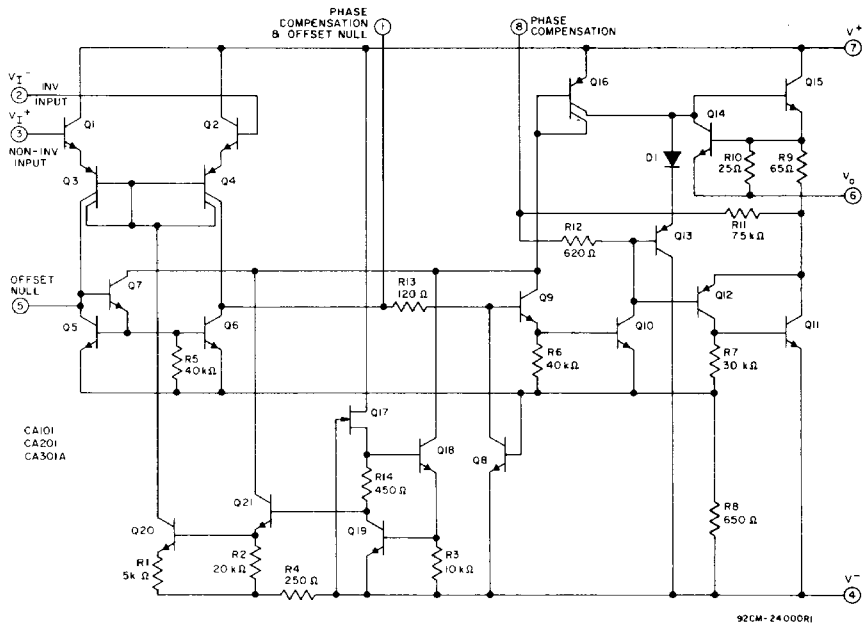

Fig. 2 - Schematic diagram.

CA101, CA201, CA301A, LM201, LM301A

ELECTRICAL CHARACTERISTICS

CHARACTERISTICS	TEST CONDITIONS Δ	LIMITS									UNITS
		CA101			CA201			CA301A			
		Min.	Typ.	Max.	Min.	Typ.	Max.	Min.	Typ.	Max.	
Input Offset Voltage V_{io}	$T_A=25^\circ\text{C}$ $R_s \leq 10\text{k}\Omega$	—	1	5	—	2	7.5	—	—	—	mV
	$R_s \leq 50\text{k}\Omega$	—	—	—	—	—	—	—	2	7.5	
	$R_s \leq 10\text{k}\Omega$	—	—	6	—	—	10	—	—	—	
	$R_s \leq 50\text{k}\Omega$	—	—	—	—	—	—	—	—	10	
Average Temperature Coefficient of Input Offset Voltage αV_{io}	$R_s \leq 10\text{k}\Omega$	—	6	—	—	10	—	—	—	—	$\mu\text{V}/^\circ\text{C}$
	$R_s \leq 50\text{k}\Omega$	—	3	—	—	6	—	—	—	—	
Average Temperature Coefficient of Input Offset Current αI_{io}	-55°C to $+25^\circ\text{C}$	—	—	—	—	—	—	—	—	—	nA/ $^\circ\text{C}$
	0°C to $+25^\circ\text{C}$	—	—	—	—	—	—	—	0.02	0.6	
	$+25^\circ\text{C}$ to $+70^\circ\text{C}$	—	—	—	—	—	—	—	0.01	0.3	
	$+25^\circ\text{C}$ to $+125^\circ\text{C}$	—	—	—	—	—	—	—	—	—	
Input Offset Current I_{io}	$T_A = 0^\circ\text{C}$	—	—	—	—	150	750	—	—	—	nA
	$T_A = 25^\circ\text{C}$	—	40	200	—	100	500	—	3	50	
	$T_A = 70^\circ\text{C}$	—	—	—	—	50	400	—	—	—	
	$T_A = 125^\circ\text{C}$	—	10	200	—	—	—	—	—	—	
	—	—	—	—	—	—	—	—	—	70	
Input Bias Current I_{IB}	$T_A = -55^\circ\text{C}$	—	0.28	1.5	—	—	—	—	—	—	μA
	$T_A = 0^\circ\text{C}$	—	—	—	—	0.32	2	—	—	—	
	$T_A = 25^\circ\text{C}$	—	0.12	0.5	—	0.25	1.5	—	0.07	0.25	
	—	—	—	—	—	—	—	—	—	0.3	
Supply Current I_{\pm}	$T_A=25^\circ\text{C}$ $V_{\pm}=15\text{V}$	—	—	—	—	—	—	—	1.8	3	mA
	$V_{\pm}=20\text{V}$	—	1.8	3	—	1.8	3	—	—	—	
	$T_A=125^\circ\text{C}$ $V_{\pm}=20\text{V}$	—	1.2	2.5	—	—	—	—	—	—	
Open-Loop Differential Voltage Gain A_{OL}	$T_A=25^\circ\text{C}$ $V_{\pm}=15\text{V}$ $V_O=\pm 10\text{V}$ $R_L \geq 2\text{k}\Omega$	50	160	—	20	150	—	25	160	—	V/mV
	$V_{\pm}=15\text{V}$ $V_O=\pm 10\text{V}$ $R_L \geq 2\text{k}\Omega$	25	—	—	15	—	—	15	—	—	
Input Resistance R_i	$T_A=25^\circ\text{C}$	0.3	0.8	—	0.1	0.4	—	0.5	2	—	M Ω
Output Voltage Swing V_{OPP}	$V_{\pm}=15\text{V}$ $R_L=10\text{k}\Omega$	± 12	± 14	—	± 12	± 14	—	± 12	± 14	—	V
Common-Mode Input-Voltage Range V_{ICR}	$V_{\pm}=15\text{V}$	± 12	—	—	± 12	—	—	± 12	—	—	V
	$V_{\pm}=20\text{V}$	—	—	—	—	—	—	—	—	—	
Common-Mode Rejection Ratio $CMRR$	$R_s \leq 10\text{k}\Omega$	70	90	—	65	90	—	—	—	—	dB
	$R_s \leq 50\text{k}\Omega$	—	—	—	—	—	—	70	90	—	
Supply-Voltage Rejection Ratio $PSRR$	$R_s \leq 10\text{k}\Omega$	70	90	—	70	90	—	—	—	—	dB
	$R_s \leq 50\text{k}\Omega$	—	—	—	—	—	—	70	90	—	

Δ Characteristics applicable over operating temperature range (T_A) as shown below, unless otherwise specified:

CA101: -55 to $+125^\circ\text{C}$; CA201, CA301A: 0 to 70°C

3
OPERATIONAL AMPLIFIERS

CA101, CA201, CA301A, LM201, LM301A

TYPICAL STATIC CHARACTERISTICS TYPE CA101

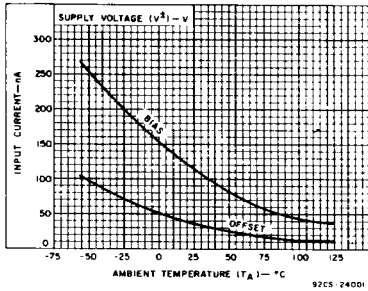

Fig. 3 - Input current (I_{i0} , I_{iB}) vs. temperature.

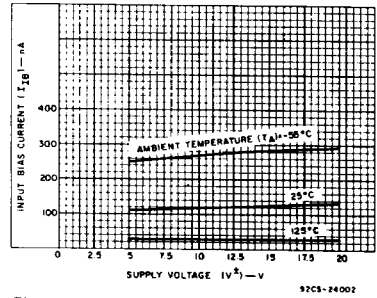

Fig. 4 - Input bias current vs. supply voltage.

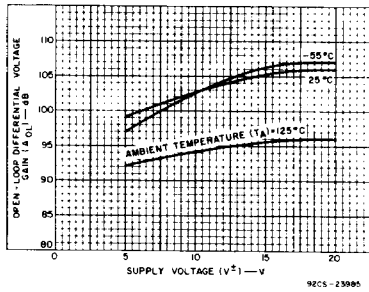

Fig. 5 - Voltage gain vs. supply voltage.

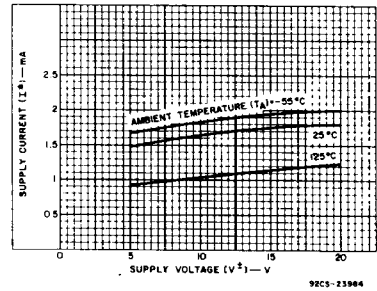

Fig. 6 - Supply characteristics.

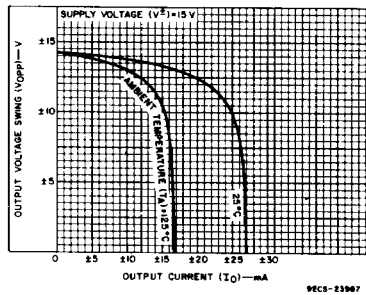

Fig. 7 - Output characteristics.

TYPE CA201

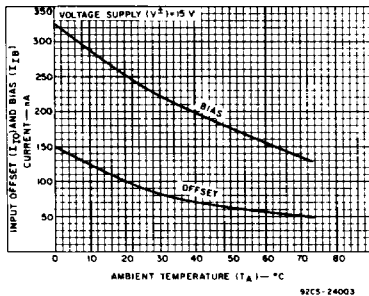

Fig. 8 - Input current (I_{i0} , I_{iB}) vs. temperature.

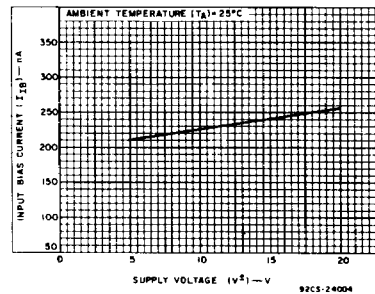

Fig. 9 - Input bias current (I_{iB}) vs. supply voltage.

CA101, CA201, CA301A, LM201, LM301A

TYPICAL STATIC CHARACTERISTICS (Cont'd)

TYPE CA201

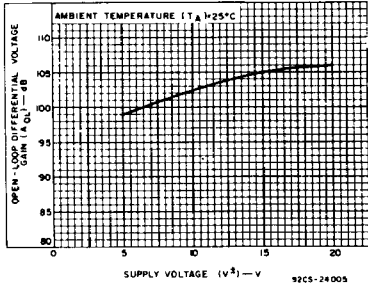

Fig. 10 - Voltage gain vs. supply voltage.

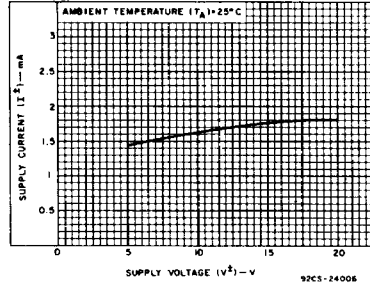

Fig. 11 - Supply characteristics.

TYPE CA301A

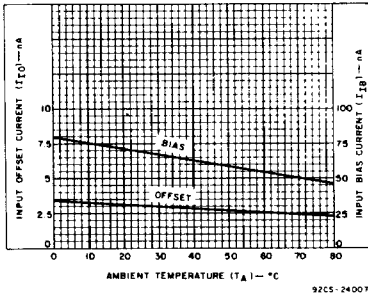

Fig. 12 - Input current (I_{I0} , I_{I2}) vs. temperature.

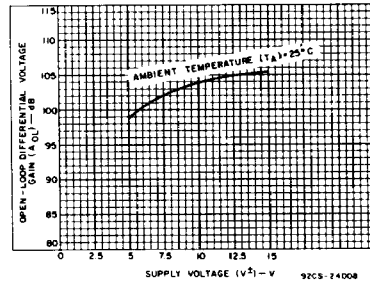

Fig. 13 - Voltage gain vs. supply voltage.

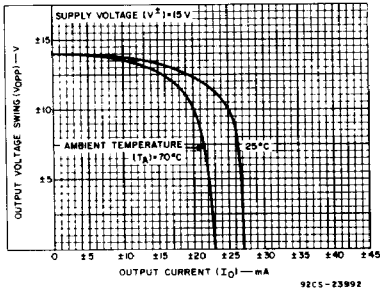

Fig. 14 - Output characteristics.

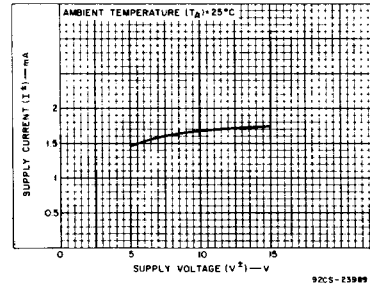

Fig. 15 - Supply characteristics.

TYPICAL DYNAMIC CHARACTERISTICS TYPES CA101, CA201, CA301A

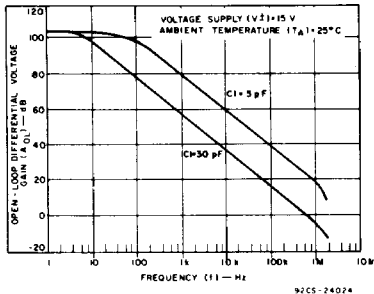

Fig. 16 - Voltage gain vs. frequency.

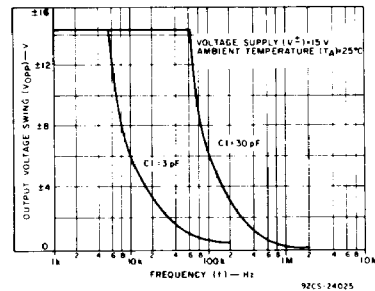

Fig. 17 - Output voltage swing vs. frequency.

CA101, CA201, CA301A, LM201, LM301A

TYPICAL DYNAMIC CHARACTERISTICS (Cont'd) FOR TYPES CA101, CA201 AND CA301A

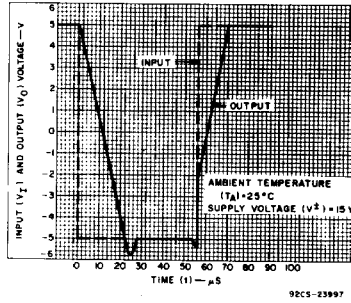

Fig. 18 - Voltage follower pulse response.

TYPE CA301A

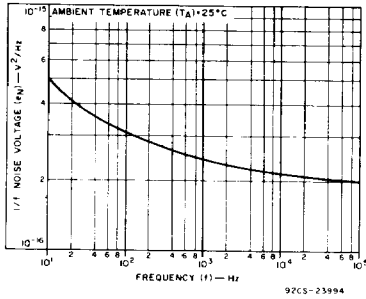

Fig. 19 - 1/f noise voltage vs. frequency.

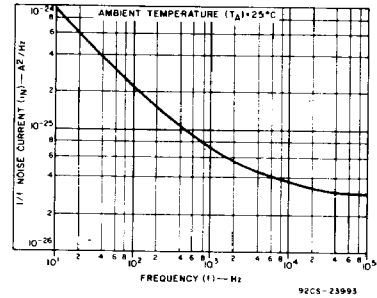
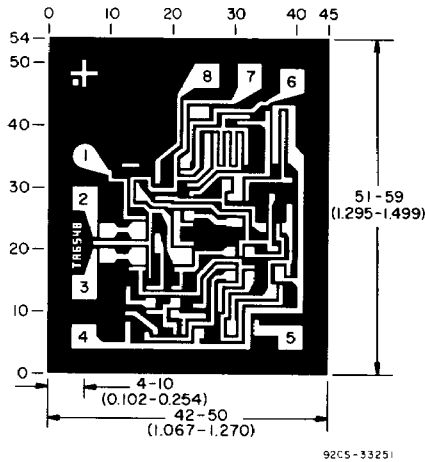

Fig. 20 - 1/f noise current vs. frequency.



Dimensions and pad layout for CA301H.

Dimensions in parentheses are in millimeters and are derived from the basic inch dimensions as indicated. Grid graduations are in mils (10^{-3} inch).