

NOT RECOMMENDED FOR NEW DESIGNS, REFER TO EVQ4433-L-00A

DESCRIPTION

The EV4433-L-00A is an evaluation board for the MP/MPQ4433GL.

MP/MPQ4433GL is a frequency programmable (350kHz to 2.5MHz), synchronous, step-down, switching regulator with integrated internal high-side and low-side power MOSFETs. It provides up to 3A highly efficient output current with current mode control for fast loop response.

The MP/MPQ4433GL employs AAM (Advanced Asynchronous Modulation) mode which helps to achieve high efficiency at light load condition by scaling down the switching frequency to reduce the switching and gate driving losses.

The EV4433-L-00A is a fully assembled and tested evaluation board, it generates +3.3V output voltage at load current up to 3A from a 3.3V to 36V input range.

ELECTRICAL SPECIFICATIONS

Parameter	Symbol	Value	Units
Input Voltage	V _{IN}	3.3 – 36	V
Output Voltage	V _{OUT}	3.3	V
Output Current	I _{OUT}	3	A

FEATURES

- Wide 3.3V-to-36V Operating Input Range
- 3A Continuous Output Current
- 1μA Low Shutdown Mode Current
- 10μA Sleep Mode Quiescent Current
- Internal 90mΩ High-Side and 40mΩ Low-Side MOSFETs
- 350kHz to 2.5MHz Programmable Switching Frequency
- Synchronize to External Clock Selectable In-Phase or 180° Out-of-Phase
- Power Good Indicator
- Programmable Soft-Start Time
- 80ns Minimum On Time
- Selectable Forced CCM and AAM
- Low Dropout Mode
- Over-Current Protection with Valley-Current Detection and Hiccup
- Thermal Shutdown
- Available in Wettable Flank
- Available in AEC-Q100 Grade-1
- Fully Assembled and Tested

APPLICATIONS

- Automotive Systems
- Industrial Power Systems

All MPS parts are lead-free, halogen free, and adhere to the RoHS directive. For MPS green status, please visit MPS website under Quality Assurance. "MPS" and "The Future of Analog IC Technology" are Registered Trademarks of Monolithic Power Systems, Inc.

EVALUATION BOARD



(L x W x H) 2.5" x 2.5" x 0.4"
(6.4cm x 6.4cm x 1.0cm)

Board Number	MPS IC Number
EV4433-L-00A	MP/MPQ4433GL

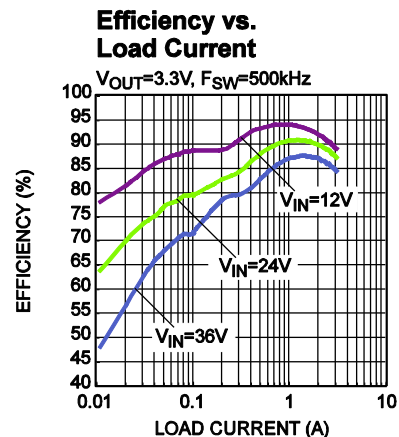

QUICK START GUIDE

1. Connect the positive and negative terminals of the load to the VOUT and GND pins, respectively.

Be aware that electronic loads represent a negative impedance to the regulator and if set to a too high current will trigger Hiccup mode.

2. Preset the power supply output to between 3.3V and 36V, and then turn it off.
If longer cables are used between the source and the EVB (>0.5m total), a damping capacitor should be installed at the input terminals. Especially when Vin is ≥ 24V.
3. Connect the positive and negative terminals of the power supply output to the VIN and GND pins, respectively.
4. Turn the power supply on. The MP/MPQ4433GL will automatically startup.
5. To use the Enable function, apply a digital input to the EN pin. Drive EN higher than 1.05V to turn on the regulator, drive EN less than 0.93V to turn it off.
6. The oscillating frequency of MP/MPQ4433 can be programmed by an external frequency resistor R_{FREQ}. The value of R_{FREQ} can be estimated with below equation:

$$R_{FREQ} (k\Omega) = \frac{170000}{f_{sw}^{1.11} (kHz)}$$

7. To use the Sync function, apply a 350kHz to 2.5MHz clock to the Sync pin to synchronize the internal oscillator frequency to the external clock. The external clock should be at least 250kHz larger than R_{FREQ} set frequency. The SYNC pin can also be used to select forced CCM mode or AAM mode. Drive it high before the chip starts up to choose forced CCM mode, and drive it low or leave it float to choose AAM mode.
8. The output voltage is set by the external resistor divider. Choose R_{FB1} to be around 40kΩ. Then R_{FB2} can be calculated with below equation:

$$R_{FB2} = \frac{R_{FB1}}{\frac{V_{OUT}}{0.8V} - 1}$$

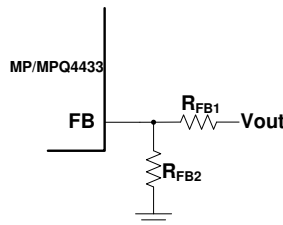

Below table lists the recommended feedback resistor values for common output voltages.

V _{OUT} (V)	R _{FB1} (kΩ)	R _{FB2} (kΩ)
1.8	41.2 (1%)	33 (1%)
2.5	41.2 (1%)	19.6 (1%)
3.3	41.2 (1%)	13 (1%)
5	41.2 (1%)	7.68 (1%)
12	41.2 (1%)	2.94 (1%)

NOT RECOMMENDED FOR NEW DESIGNS, REFER TO EVQ4433-L-00A

EVALUATION BOARD SCHEMATIC

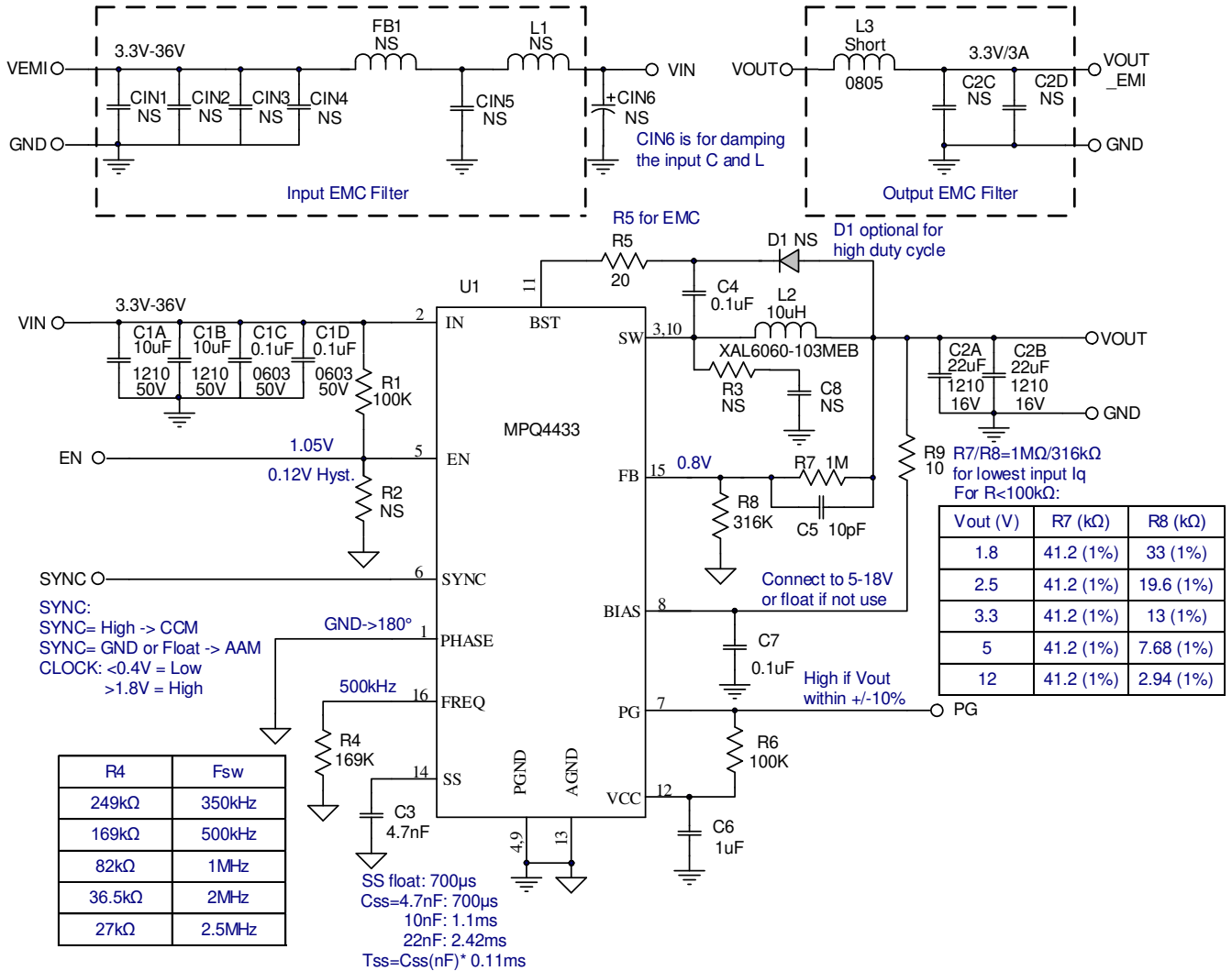

EV4433-L-00A BILL OF MATERIALS

Qty	Ref	Value	Description	Package	Manufacturer	Part Number
2	C1A, C1B	10 μ F	Ceramic Cap; 50V;X7R;1210	1210	muRata	GRM32ER71H106KA12L
2	C1C, C1D	0.1 μ F	Ceramic Cap; 50V;X7R;0603	0603	muRata	GRM188R71H104KA93D
2	C2A, C2B	22 μ F	Ceramic Cap; 16V;X7R;1210	1210	muRata	GRM32ER71C226KEA8L
1	C3	4.7nF	Ceramic Cap; 50V;X7R;0603	0603	muRata	GRM188R71H472KA01D
2	C4, C7	0.1 μ F	Ceramic Cap; 16V;X7R;0603	0603	muRata	GRM188R71C104KA01D
1	C5	10pF	Ceramic Cap; 50V;C0G;0603	0603	muRata	GRM1885C1H100JA01
1	C6	1 μ F	Ceramic Cap; 16V;X7R;0603	0603	muRata	GRM188R71C105KA12D
9	C1N1-C1N6, C2C, C2D, C8	NS				
1	FB1	NS				
1	D1	NS				
1	L1	NS				
1	L2	10 μ H	Inductor, 27mOhm DCR, 7.6A	SMD	Coilcraft	XAL6060-103MEB
1	L3	Short				
2	R1, R6	100k	Film Res., 5%	0603	Yageo	RC0603JR-07100KL
1	R4	169k	Film Res., 1%	0603	Yageo	RC0603FR-07169KL
1	R5	20	Film Res., 1%	0603	Yageo	RC0603FR-0720RL
1	R7	1M	Film Res., 1%	0603	Yageo	RC0603FR-071ML
1	R8	316k	Film Res., 1%	0603	Yageo	RC0603FR-07316KL
1	R9	10	Film Res., 5%	0603	Yageo	RC0603JR-0710RL
2	R2, R3	NS				
1	U1		Step-Down Regulator	QFN-16 (3mmX4mm)	MPS	MPQ4433GL
5	VIN, VEMI, GND, VOUT, GND		2.0 Golden Pin		HZ	
5	EN, GND, SYNC, GND, PG		1.0 Golden Pin		HZ	

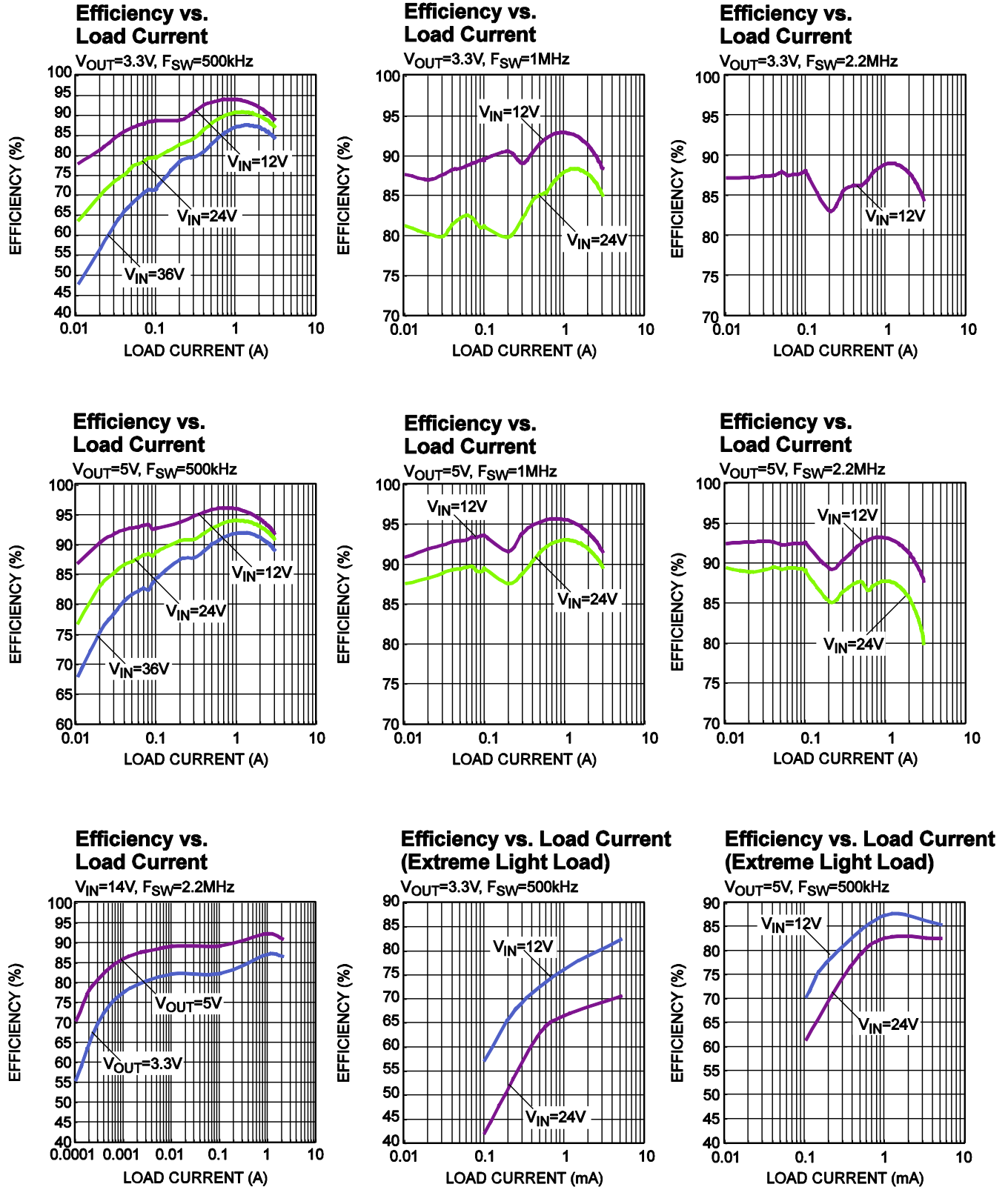
EVB TEST RESULTS
 $V_{IN} = 12V$, $V_{OUT} = 3.3V$, $L = 10\mu H$, $F_{SW} = 500kHz$, AAM mode, $T_A = +25^\circ C$, unless otherwise noted.

EVB TEST RESULTS (continued)

Performance waveforms are tested on the evaluation board.

 $V_{IN} = 12V$, $V_{OUT} = 3.3V$, $L = 10\mu H$, $F_{SW} = 500kHz$, AAM mode, $T_A = +25^\circ C$, unless otherwise noted.

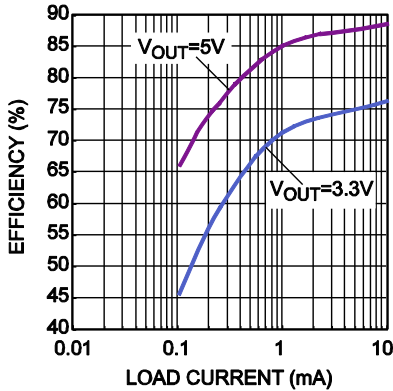
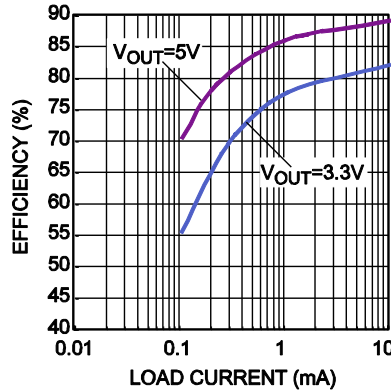
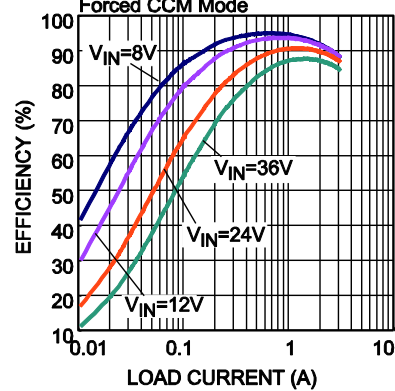
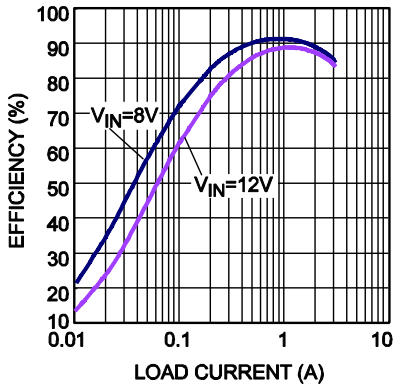
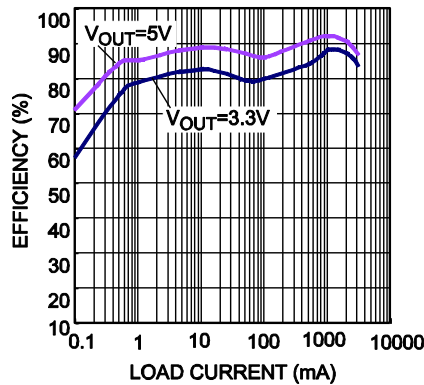
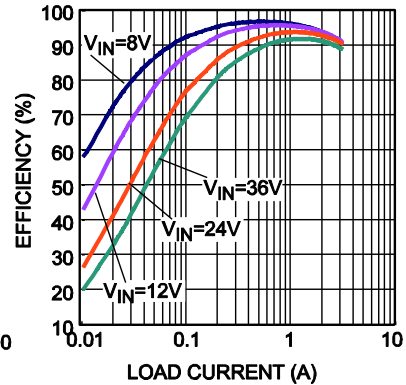
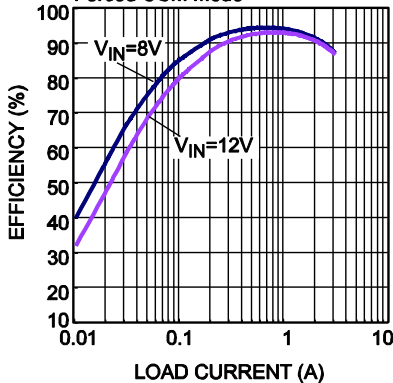
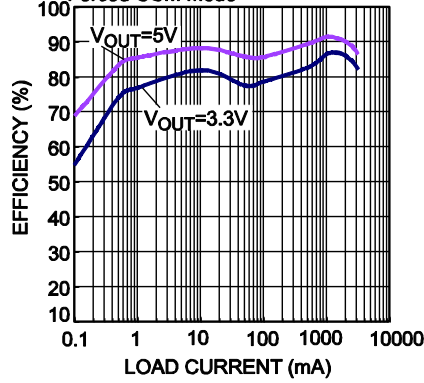
Efficiency vs. Load Current (Extreme Light Load)
 $V_{IN} = 14V$, $F_{SW} = 400kHz$

Efficiency vs. Load Current (Extreme Light Load)
 $V_{IN} = 14V$, $F_{SW} = 2.2MHz$

Efficiency vs. Load Current
 $V_{OUT} = 3.3V$, $F_{SW} = 500kHz$, Forced CCM Mode

Efficiency vs. Load Current
 $V_{OUT} = 3.3V$, $F_{SW} = 2.2MHz$, Forced CCM Mode

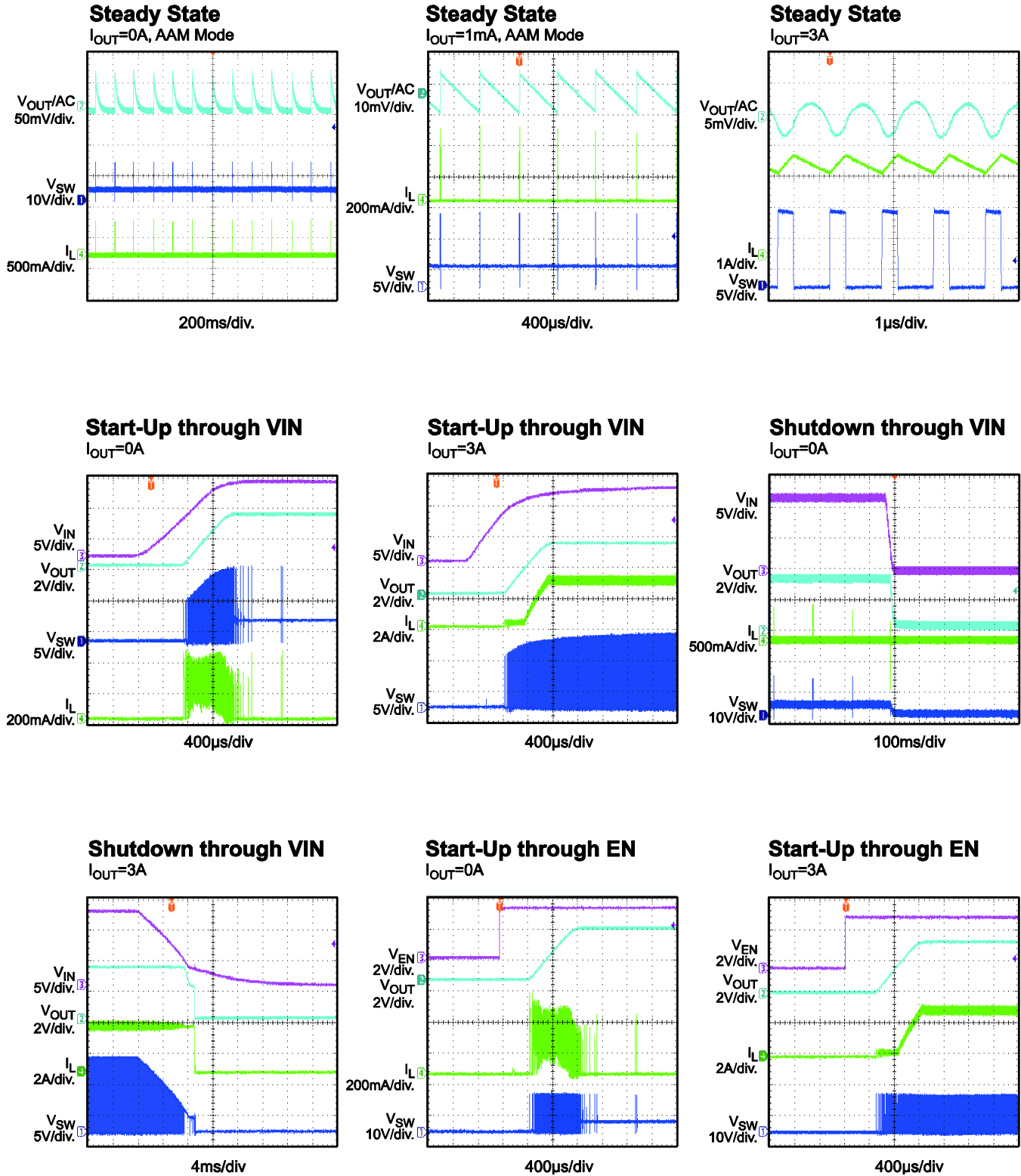
Efficiency vs. Load Current
 $V_{IN} = 12V$, $F_{SW} = 2.2MHz$, $L = 2.2\mu H$

Efficiency vs. Load Current
 $V_{OUT} = 5V$, $F_{SW} = 500kHz$, Forced CCM Mode

Efficiency vs. Load Current
 $V_{OUT} = 5V$, $F_{SW} = 2.2MHz$, Forced CCM Mode

Efficiency vs. Load Current
 $V_{OUT} = 5V$, $F_{SW} = 2.2MHz$, Forced CCM Mode

EVB TEST RESULTS *(continued)*

Performance waveforms are tested on the evaluation board.

$V_{IN} = 12V$, $V_{OUT} = 3.3V$, $L = 10\mu H$, $F_{SW} = 500kHz$, AAM mode, $T_A = +25^\circ C$, unless otherwise noted.



EVB TEST RESULTS (continued)

Performance waveforms are tested on the evaluation board.

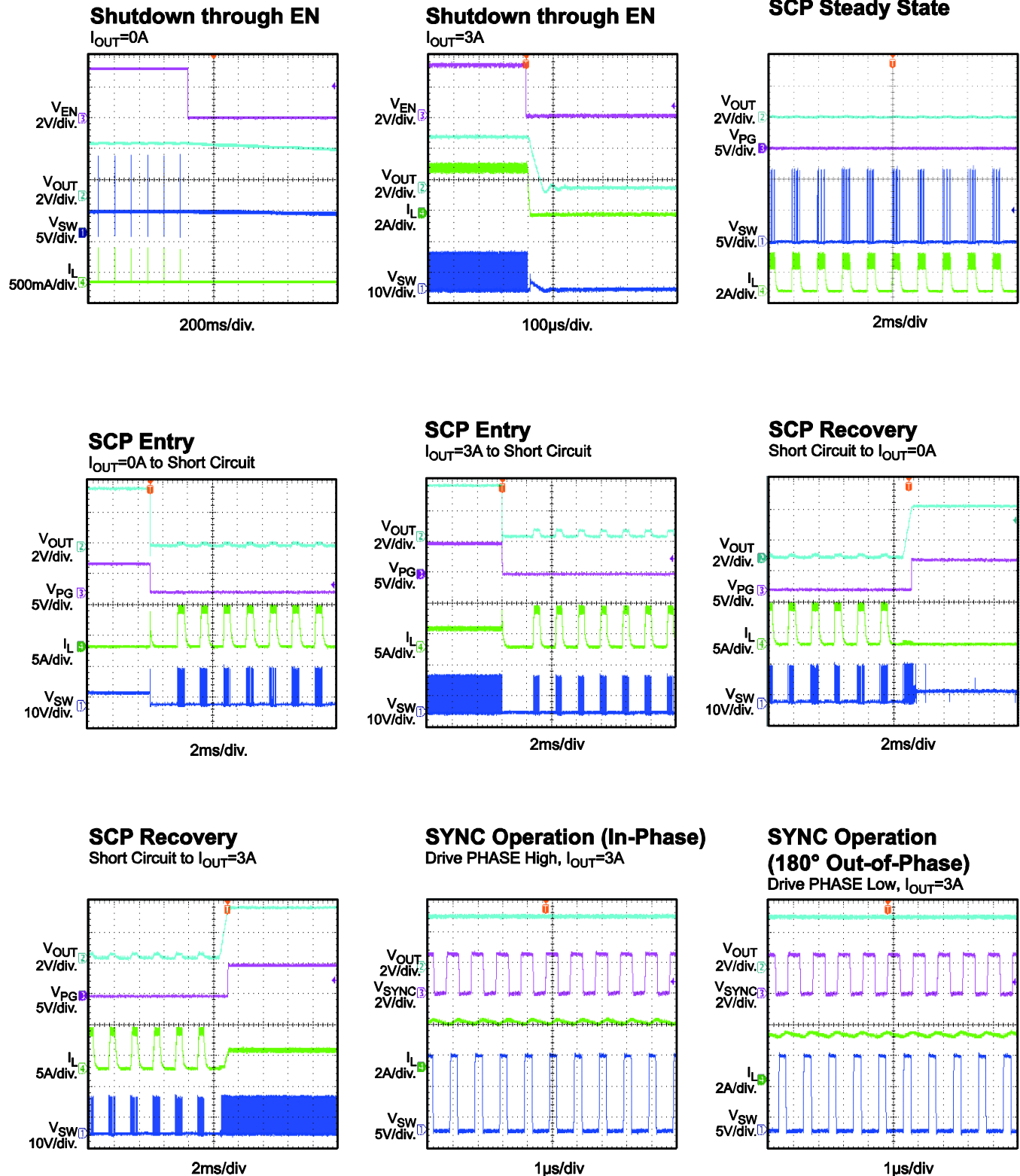
 $V_{IN} = 12V$, $V_{OUT} = 3.3V$, $L = 10\mu H$, $F_{SW} = 500kHz$, AAM mode, $T_A = +25^\circ C$, unless otherwise noted.

EVB TEST RESULTS *(continued)*

Performance waveforms are tested on the evaluation board.

$V_{IN} = 12V$, $V_{OUT} = 3.3V$, $L = 10\mu H$, $F_{SW} = 500kHz$, AAM mode, $T_A = +25^\circ C$, unless otherwise noted.

Forced CCM Operation
 $I_{OUT} = 0A$, Forced CCM Mode

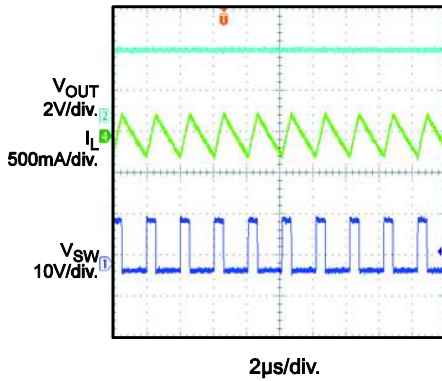

Dropout Operation
 $V_{IN} = 3.3V$, V_{OUT} Set to 3.3V, $I_{OUT} = 0A$

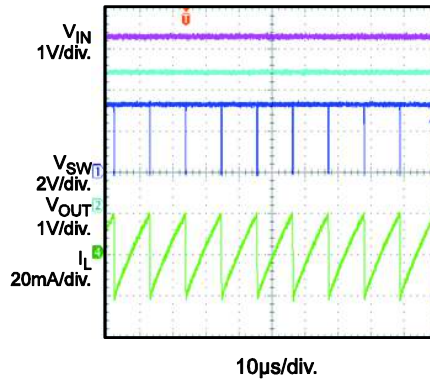

Dropout Operation
 $V_{IN} = 3.3V$, V_{OUT} Set to 3.3V, $I_{OUT} = 3A$

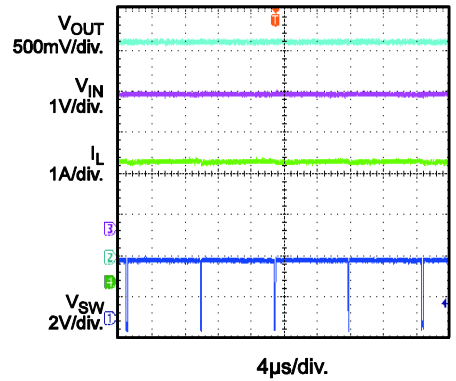

Load Transient
 $I_{OUT} = 1.5A \rightarrow 3A$, 1.6A/µs

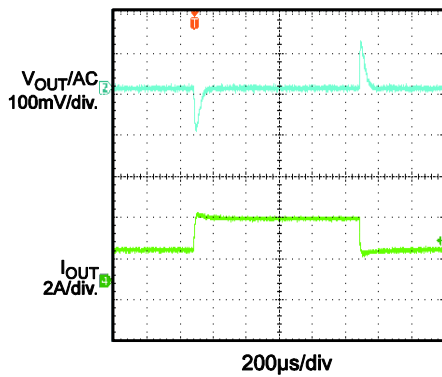

VIN Ramp Up and Down
 $I_{OUT} = 0.1A$

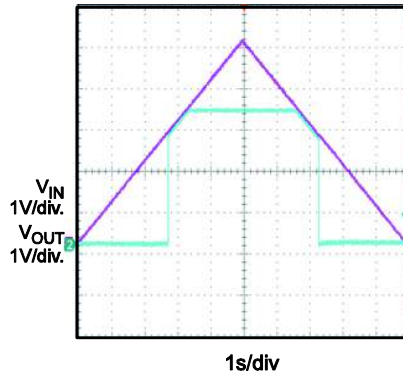

VIN Ramp Down and Up
 $I_{OUT} = 1mA$

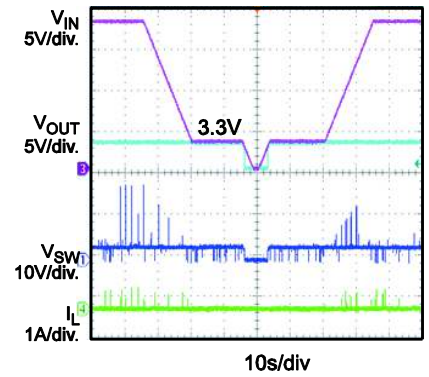

VIN Ramp Down and Up
 $I_{OUT} = 3A$

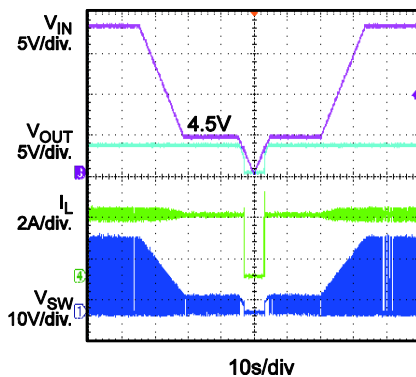

Cold-Crank
 $V_{IN} = 12V \rightarrow 3.3V \rightarrow 5V$, $I_{OUT} = 3A$

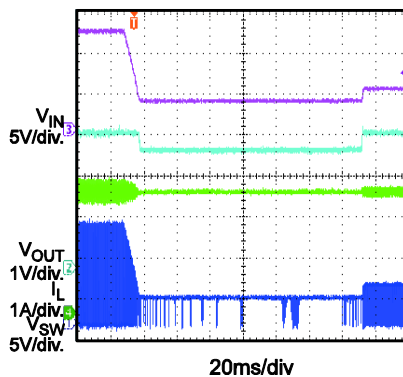

Load Dump
 $V_{IN} = 12V \rightarrow 36V$, $I_{OUT} = 3A$

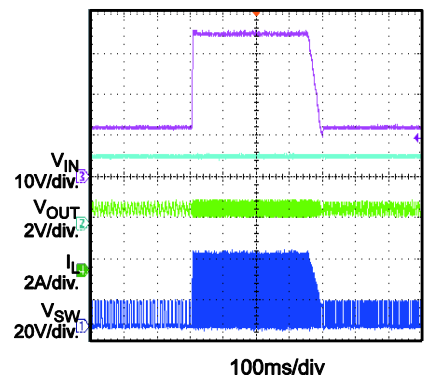

PRINTED CIRCUIT BOARD LAYOUT

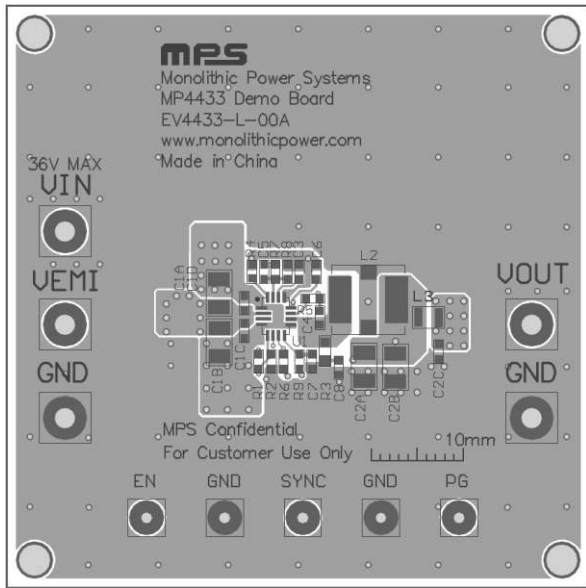

Figure 1—Top Silk Layer and Top Layer

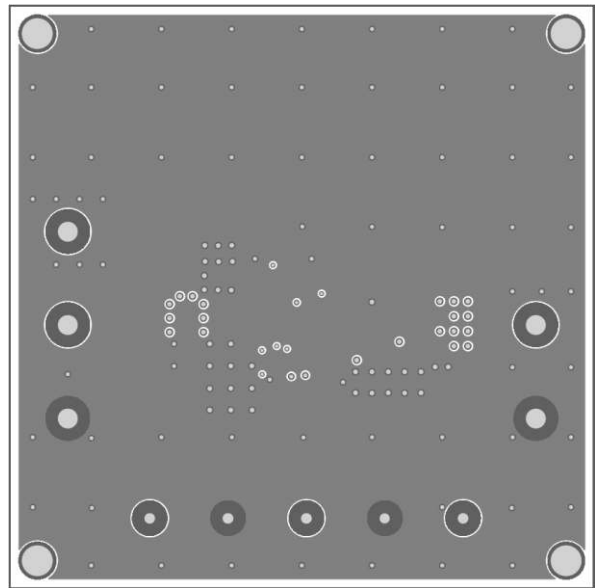

Figure 2—Inner1 Layer

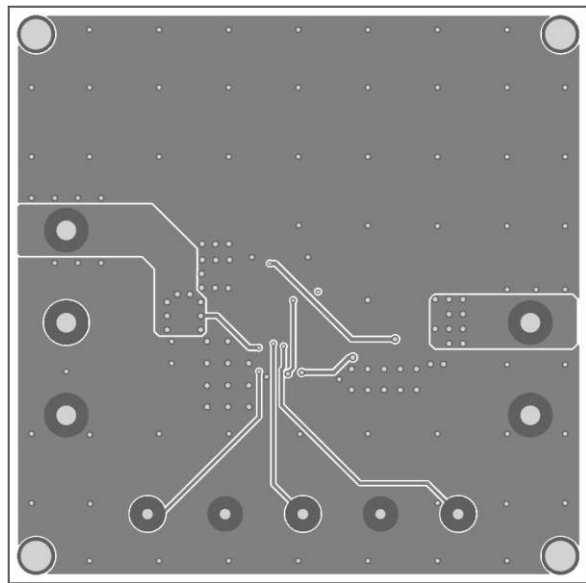

Figure 3—Inner2 Layer

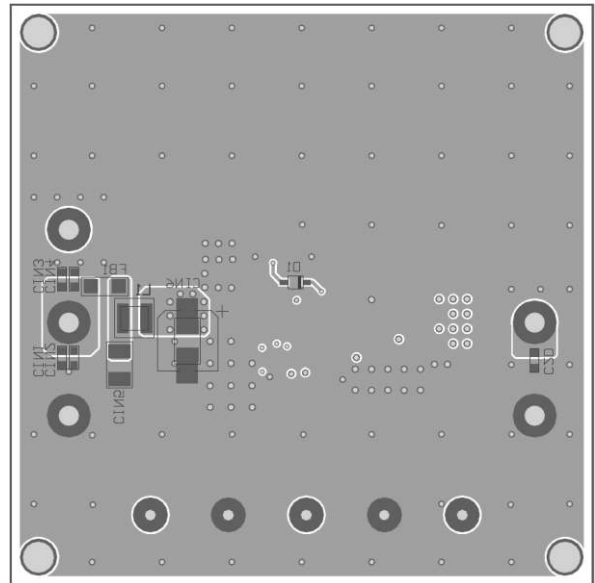

Figure 4—Bottom Silk Layer and Bottom Layer

NOTICE: The information in this document is subject to change without notice. Users should warrant and guarantee that third party Intellectual Property rights are not infringed upon when integrating MPS products into any application. MPS will not assume any legal responsibility for any said applications.