

## High Power LED Series Chip Scale Package

# LH151B

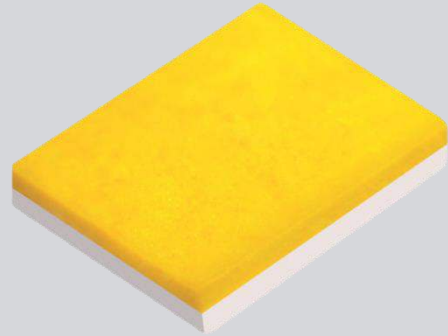

Use of Samsung's Chip Scale Package technology  
provide high performance and energy conserving



### Features & Benefits

- Utilizes Samsung TF chip technology
- Suitable for use in indoor and outdoor lighting
- Operates at a maximum current of up to 0.7 A
- Compact footprint (1.7 x 1.7 mm)

### Applications

- Indoor Lighting: Spotlight, Downlight, MR, PAR
- Outdoor Lighting: Street Light, Tunnel Light, Security Light, Parking Lot Light
- Industrial Lighting: High Bay Light, Low Bay Light
- Consumer Lighting: Torch Light

## Table of Contents

1.	Characteristics	-----	3
2.	Product Code Information	-----	6
3.	Typical Characteristics Graphs	-----	11
4.	Outline Drawing & Dimension	-----	13
5.	Reliability Test Items & Conditions	-----	14
6.	Soldering Conditions	-----	15
7.	Tape & Reel	-----	16
8.	Label Structure	-----	18
9.	Packing Structure	-----	19
10.	Precautions in Handling & Use	-----	21

## 1. Characteristics

### a) Absolute Maximum Rating

Item	Symbol	Rating	Unit	Condition
Ambient / Operating Temperature	$T_a$	-40 ~ +100	°C	Note 1)
Storage Temperature	$T_{stg}$	-40 ~ +125	°C	-
LED Junction Temperature	$T_j$	135	°C	-
Forward Current	$I_F$	700	mA	Note 1)
Peak Pulse Forward Current	$I_{FP}$	1000	mA	Duty 1/10 pulse width 10ms
Assembly Process Temperature	-	255 <20	°C s	-
ESD (HBM)	-	±2	kV	-

#### Note:

- 1) Refer to the derating curve, '3. Typical Characteristics Graph', for proper driving current that maintained below maximum junction temperature.

## b) Electro-optical Characteristics

Item	Unit	Nominal CCT (K)	Condition		Value Typ.
			I <sub>F</sub> (mA)	T <sub>J</sub> (°C)	
Luminous Flux (Φ <sub>v</sub> )	lm	4000 (70 CRI)	150	85	75
			350	25	175
			350	85	160
			500	85	215
			700	85	277
Forward Voltage (V <sub>F</sub> )	V		150	25	2.68
			350	25	2.96
			350	85	2.84
			500	85	2.94
			700	85	3.05
Thermal Resistance (junction to solder point)	K/W				2
Beam Angle	°				120

**Note:**

Samsung maintains measurement tolerance of: luminous flux = ±7%, forward voltage = ±0.1 V

### c) Luminous Flux Characteristics (T<sub>s</sub> = 85 °C)

Sorting @ 350 mA (lm)			Calculated Minimum Flux <sup>2)</sup> (lm)			
Flux Rank	Flux Range <sup>1)</sup>	Sub Rank	@ 150 mA	@ 350 mA	@ 500 mA	@ 700 mA
E3	80 ~ 110	E1, F1, G1	37	80	108	139
F3	90 ~ 120	F1, G1, H1	42	90	121	156
G3	100 ~ 130	G1, H1, J1	47	100	135	173
H3	110 ~ 140	H1, J1, K1	51	110	148	191
J3	120 ~ 150	J1, K1, M1	56	120	161	208
K3	130 ~ 160	K1, M1, N1	61	130	175	225
M3	140 ~ 170	M1, N1, P1	65	140	188	242
N3	150 ~ 180	N1, P1, Q1	70	150	202	260
P3	160 ~ 190	P1, Q1, R1	75	160	215	277
Q3	170 ~ 200	Q1, R1, S1	79	170	229	294
R3	180 ~ 210	R1, S1, T1	84	180	242	312
S3	190 ~ 220	S1, T1, U1	89	190	256	329
T3	200 ~ 230	T1, U1, V1	93	200	269	346
U3	210 ~ 240	U1, V1, W1	98	210	282	364
V3	220 ~ 250	V1, W1, X1	103	220	296	381
W3	230 ~ 260	W1, X1, Y1	107	230	309	398
X3	240 ~ 270	X1, Y1, Z1	112	240	323	416
Y3	250 ~ 280	Y1, Z1, 11	117	250	336	433
Z3	260 ~ 290	Z1, 11, 21	121	260	350	450

#### Notes:

- 1) Samsung maintains measurement tolerance of: luminous flux =  $\pm 7\%$ , CRI =  $\pm 3$
- 2) Calculated minimum flux values are for reference only

## 2. Product Code Information

<u>1</u>	<u>2</u>	<u>3</u>	<u>4</u>	<u>5</u>	<u>6</u>	<u>7</u>	<u>8</u>	<u>9</u>	<u>10</u>	<u>11</u>	<u>12</u>	<u>13</u>	<u>14</u>	<u>15</u>	<u>16</u>	<u>17</u>	<u>18</u>
S	C	P	7	T	T	9	3	K	E	L	1	T	L	N	3	6	E

Digit	PKG Information	Code	Specification	
1 2 3	Samsung Chip Scale Package	SCP		
4	CRI	7 8 9	CRI 70 CRI 80 CRI 90	
5	CCT(K)	W V U T R Q P	2700K 3000K 3500K 4000K 5000K 5700K 6500K	
6	Chip Shape	T	Square type	
7 8 9	Product	93K	Chip version	
10 11 12	Product Purpose	EL1	FEC for lighting	
13	CCT (K)	W V U T R Q P	2700K 3000K 3500K 4000K 5000K 5700K 6500K	
14	MacAdam Step	L U	Full Bin for MacAdam 5-Step Full Bin for MacAdam 3-Step	
15 16	Luminous Flux	F3 G3 H3 J3 K3 M3 N3 P3 Q3	F1 90-100 G1 100-110 H1 110-120 J1 120-130 K1 130~140 M1 140~150 N1 150~160 P1 160~170 Q1 170~180	<p>Digit 15: Min. spec Digit 16: The number of higher bin(s) from min. spec. e.g.: K1 = 130~140 lm, K3 = 130~160 lm</p>
17 18	Forward Voltage (Vf)	6 E	2.7 ~ 3.1 V	Bin 6A 2.7~2.9 Code AE 2.9~3.1

a) Luminous Flux Bins ( $I_F = 350 \text{ mA}$ ,  $T_s = 85 \text{ }^\circ\text{C}$ )

CRI/ Nominal CCT (K)	Flux rank											
	E <sub>1</sub>	F <sub>1</sub>	G <sub>1</sub>	H <sub>1</sub>	J <sub>1</sub>	K <sub>1</sub>	M <sub>1</sub>	N <sub>1</sub>	P <sub>1</sub>	Q <sub>1</sub>	R <sub>1</sub>	
	(min. flux)	80	90	100	110	120	130	140	150	160	170	180
70	2700					SCP7WT93KEL1W◇J36E						
	3000						SCP7VT93KEL1V◇K36E					
	3500							SCP7UT93KEL1U◇M36E				
	4000								SCP7TT93KEL1T◇N36E			
	5000								SCP7RT93KEL1R◇N36E			
	5700								SCP7QT93KEL1Q◇M36E			
	6500								SCP7PT93KEL1P◇M36E			
80	2700					SCP8WT93KEL1W◇J36E						
	3000					SCP8VT93KEL1V◇J36E						
	3500						SCP8UT93KEL1U◇K36E					
	4000						SCP8TT93KEL1T◇K36E					
	5000							SCP8RT93KEL1R◇M36E				
	5700							SCP8QT93KEL1Q◇M36E				
	6500							SCP8PT93KEL1P◇K36E				
90	2700		SCP9WT93KEL1W◇G36E									
	3000		SCP9VT93KEL1V◇G36E									
	3500			SCP9UT93KEL1U◇H36E								
	4000				SCP9TT93KEL1T◇J36E							
	5000					SCP9RT93KEL1R◇J36E						

**Notes:**

1) ◇ : MacAdam step code, L(MacAdam 5-step) / U(MacAdam 3-step)

**b) Color Bins ( $I_F = 350 \text{ mA}$ ,  $T_s = 85 \text{ }^\circ\text{C}$ )**

Nominal CCT (K)	CRI ( $R_a$ )	Color Rank	Chromaticity Bins
2700, 3000, 3500, 4000, 5000, 5700, 6500	70		
2700, 3000, 3500, 4000, 5000, 5700, 6500	80	L (Full Bin for MacAdam 5-step)	☆L
		U (Full Bin for MacAdam 3-step)	☆U
2700, 3000, 3500, 4000, 5000,	90		

**Notes:**

1) ☆ : Nominal CCT code, W(2700)/V(3000K)/U(3500K)/T(4000K)/R(5000K)/Q(5700K)/P(6500K)

**c) Voltage Bins ( $I_F = 350 \text{ mA}$ ,  $T_s = 85 \text{ }^\circ\text{C}$ )**

CRI ( $R_a$ )	Nominal CCT (K)	Product Code	Voltage Rank	Voltage Bin	Voltage Range (V)
			6E	6A	2.7 ~ 2.9
				AE	2.9 ~ 3.1



d) Chromaticity Region & Coordinates ( $I_F = 350 \text{ mA}$ ,  $T_s = 85 \text{ }^\circ\text{C}$ )

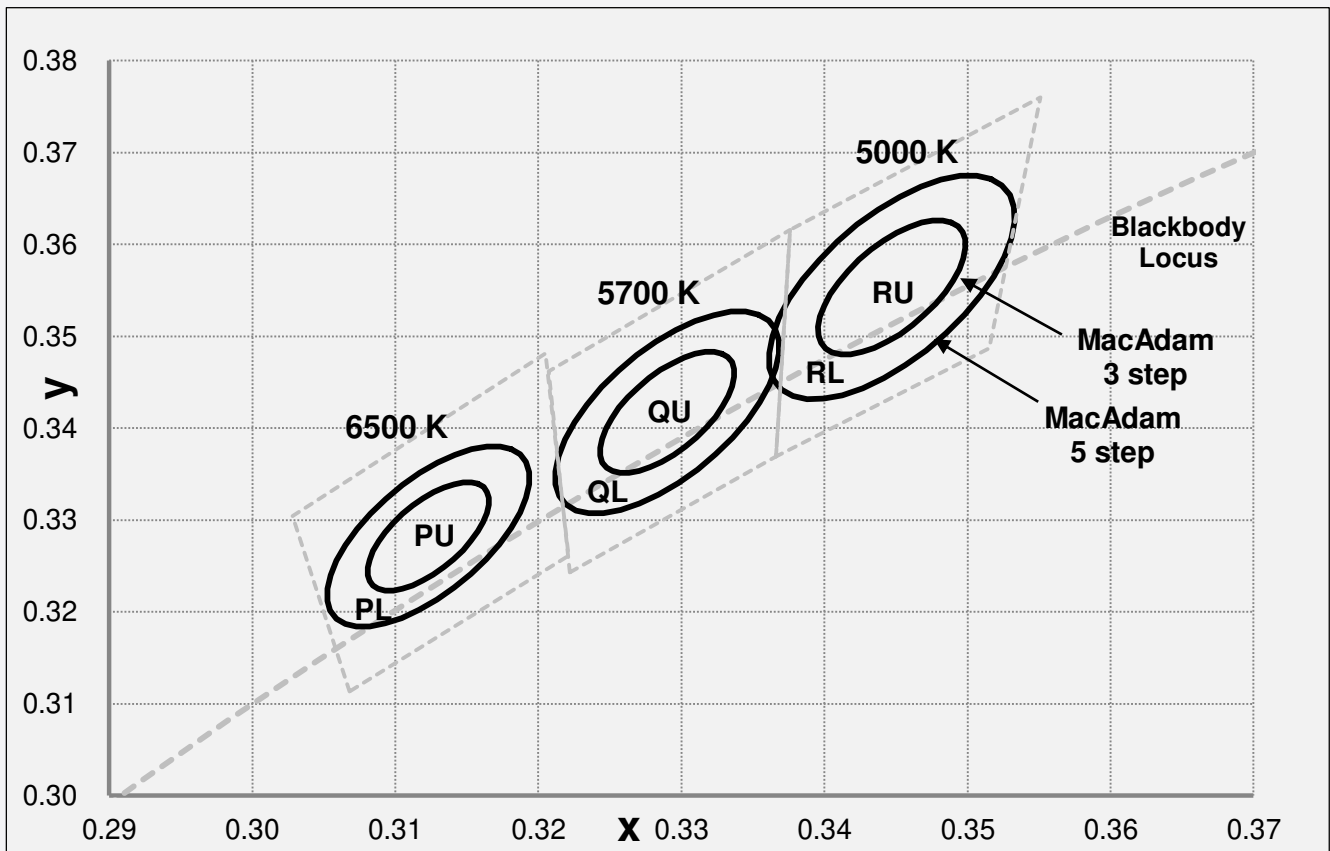
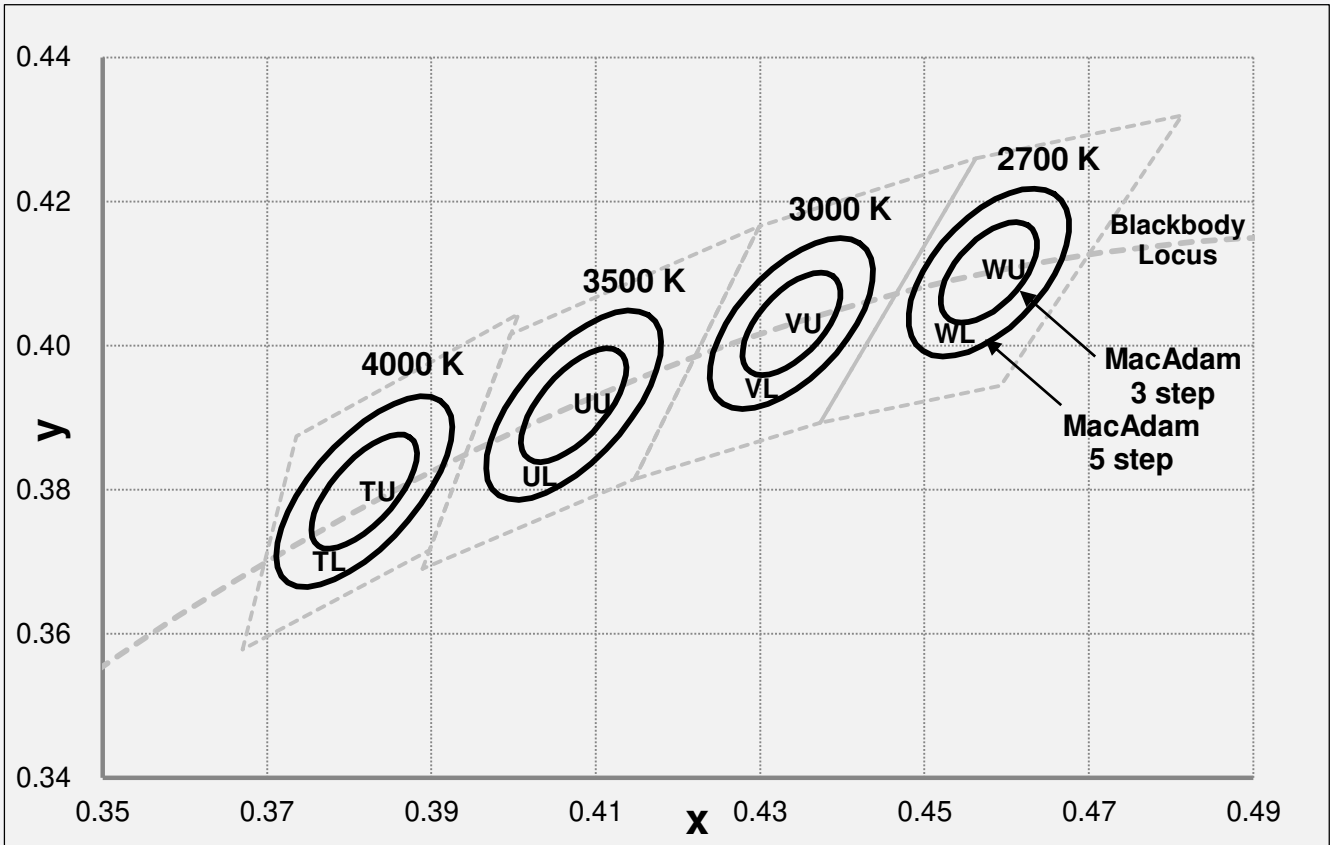

### e) Chromaticity Region & Coordinates ( $I_F = 350 \text{ mA}$ , $T_s = 85 \text{ }^\circ\text{C}$ )

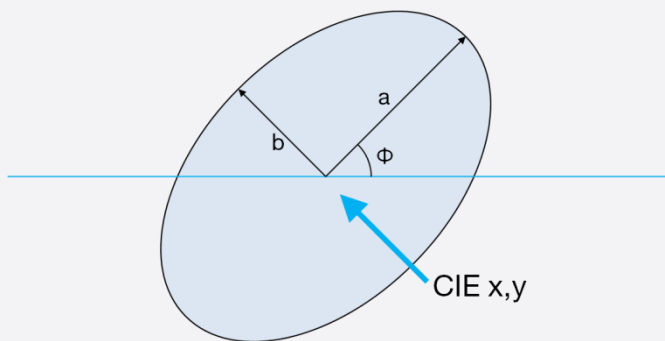

	CCT (K)	Center point		Major-axis	Minor-axis	Rotation
		CIE x	CIE y	a	b	$\Phi$
3 step	2700	0.4578	0.4101	0.0081	0.0042	53.70
	3000	0.4338	0.4030	0.0083	0.0041	53.22
	3500	0.4073	0.3917	0.0093	0.0041	54.00
	4000	0.3818	0.3797	0.0094	0.0040	53.72
	5000	0.3447	0.3553	0.0082	0.0035	59.62
	5700	0.3287	0.3417	0.0075	0.0032	59.10
	6500	0.3123	0.3282	0.0067	0.0029	58.57
5 step	2700	0.4578	0.4101	0.0135	0.0070	53.70
	3000	0.4338	0.4030	0.0138	0.0068	53.22
	3500	0.4073	0.3917	0.0155	0.0068	54.00
	4000	0.3818	0.3797	0.0157	0.0067	53.72
	5000	0.3447	0.3553	0.0137	0.0058	59.62
	5700	0.3287	0.3417	0.0125	0.0053	59.10
	6500	0.3123	0.3282	0.0112	0.0048	58.57

#### Note:

Samsung maintains measurement tolerance of:  $C_x, C_y = \pm 0.005$

### 3. Typical Characteristics Graphs

#### a) Spectrum Distribution ( $I_F = 350 \text{ mA}$ , $T_s = 85 \text{ }^\circ\text{C}$ )

3000K/CRI70

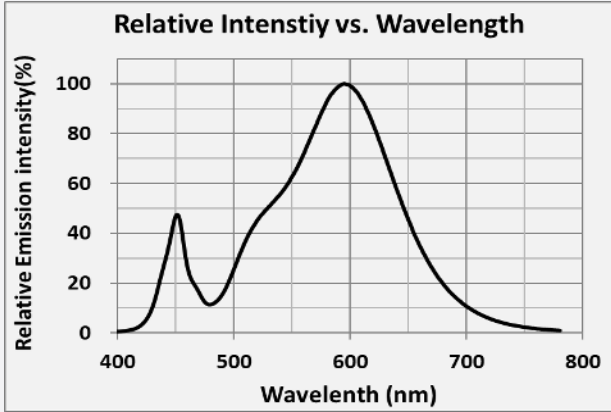

5000K/CRI70

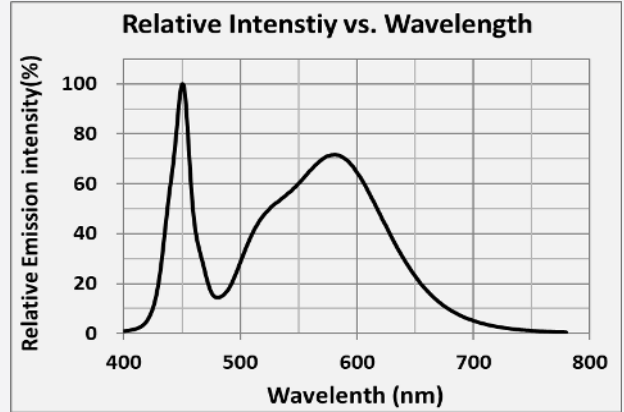

#### b) Forward Current Characteristics ( $T_s = 85 \text{ }^\circ\text{C}$ )

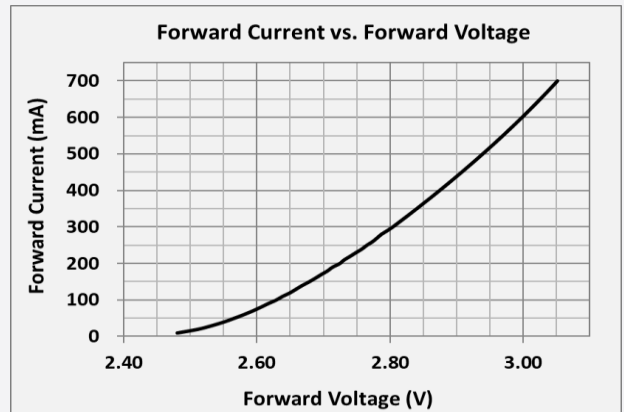
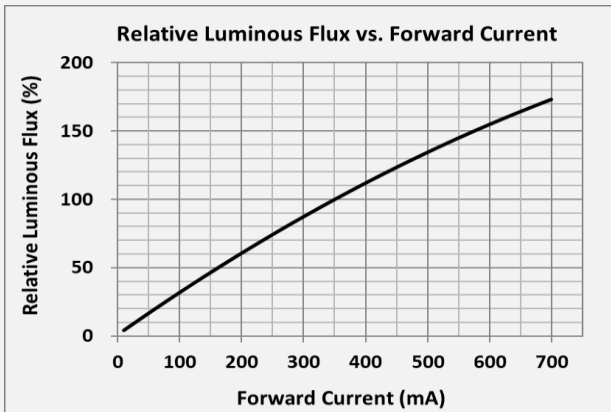

#### c) Temperature Characteristics ( $I_F = 350 \text{ mA}$ )

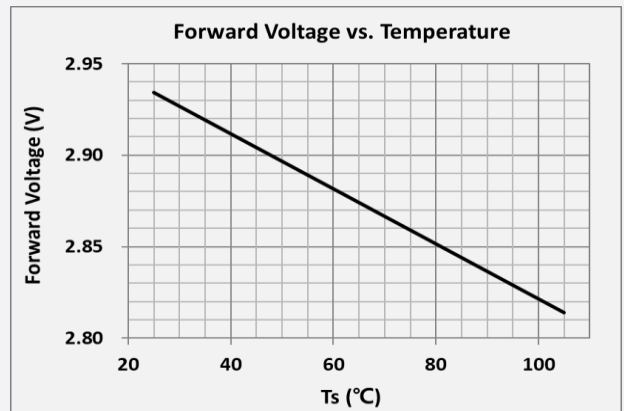
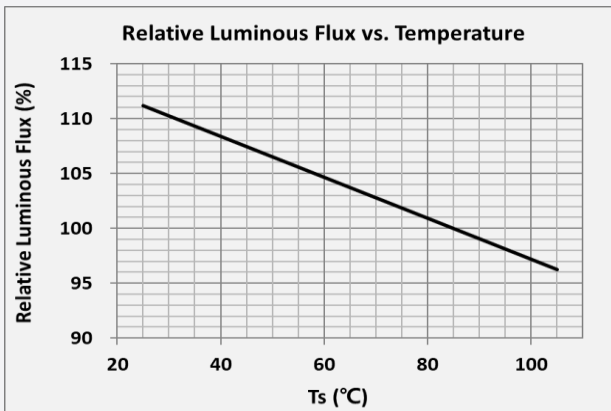

d) Color Shift Characteristics ( $I_F = 350 \text{ mA}$ ,  $T_s = 85 \text{ }^\circ\text{C}$ )

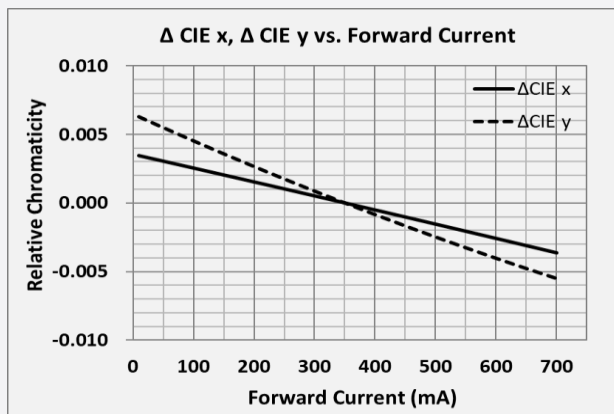
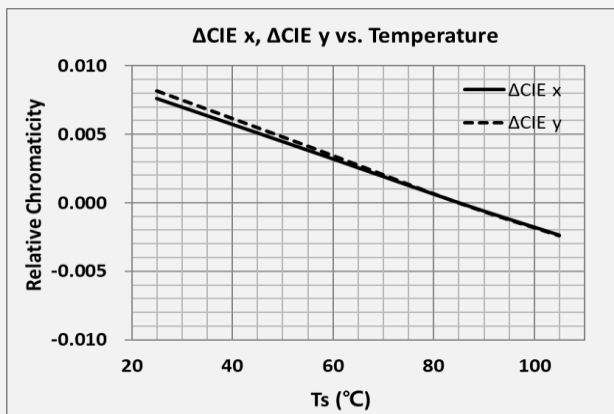

e) Derating Curve and Beam Angle Characteristics ( $I_F = 350 \text{ mA}$ ,  $T_s = 25 \text{ }^\circ\text{C}$ )

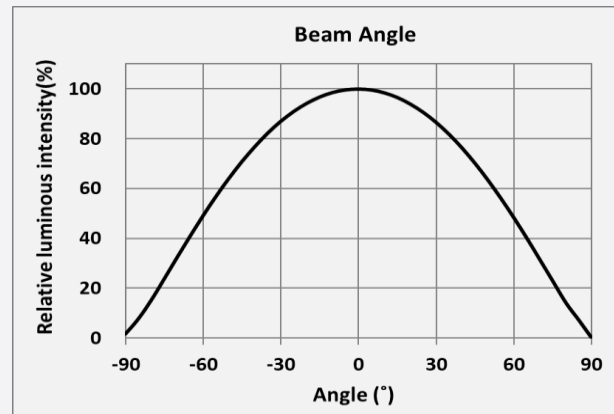
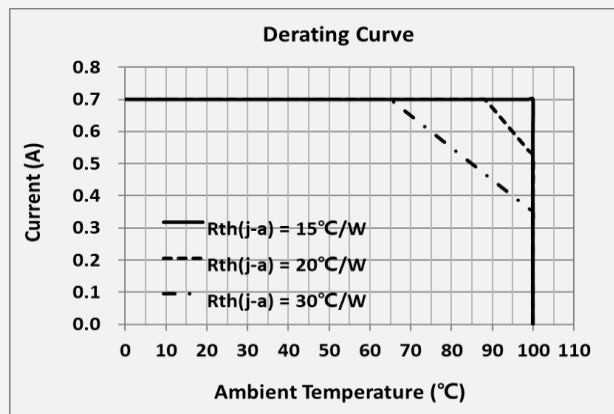

#### 4. Outline Drawing & Dimension

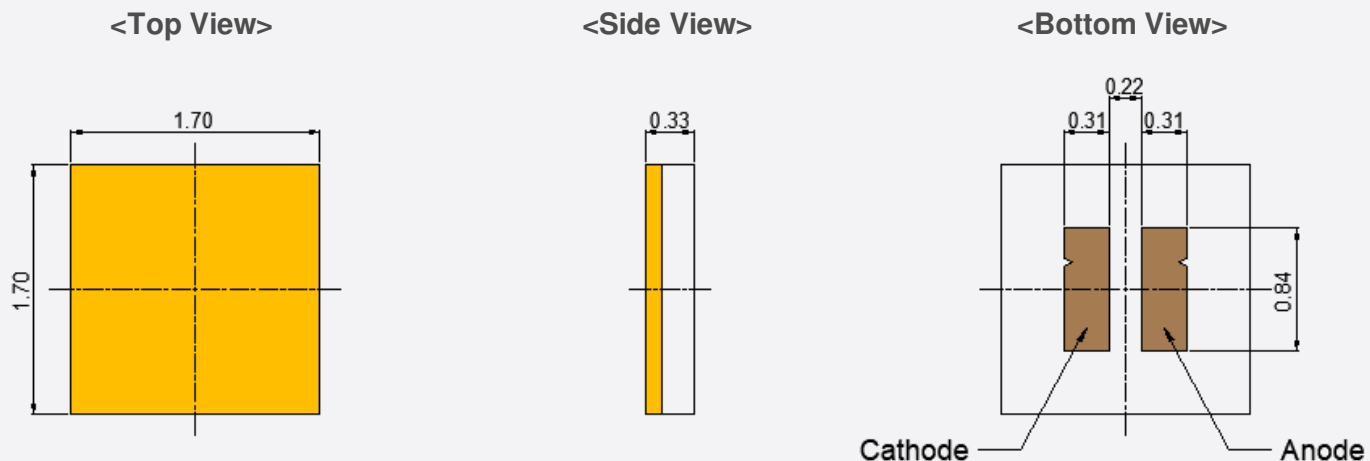

- Measurement unit: mm
- Tolerance:  $\pm 0.13$  mm

#### Precautions:

- 1) Pressure on the LEDs will influence to the reliability of the LEDs. Precautions should be taken to avoid strong pressure on the LEDs. Do not put stress on the LEDs during heating.
- 2) Re-soldering should not be done after the LEDs have been soldered. If re-soldering is unavoidable, LED's characteristics should be carefully checked before and after such repair.
- 3) Do not stack assembled PCBs together. Since materials of LEDs is soft, abrasion between two PCB assembled with LED might cause catastrophic failure of the LEDs.

## 5. Reliability Test Items & Conditions

### a) Test Items

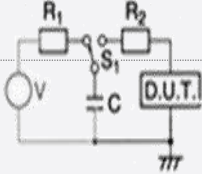
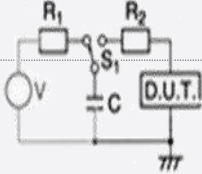
Test Item	Test Condition	Test Hour / Cycle
Room Temperature Life Test	25 °C, Derated maximum current	1000 h
High Temperature Life Test	85 °C, Derating maximum current	1000 h
High Temperature Humidity Life Test	60 °C, 90% RH, Derating maximum current	1000 h
Low Temperature Life Test	-40 °C, Derating maximum current	1000 h
Temperature Humidity Cycle Test	-10 °C ↔ 25 °C /Dry, 25 °C ↔ 65 °C /95% R.H. Derating maximum current	10 cycles
Thermal Shock	-40 °C ↔ 125 °C, each 15 min Transfer time within 5 min	500 cycles
High Temperature Storage	120 °C	1000 h
Low Temperature Storage	-40 °C	1000 h
ESD (HBM)	 R <sub>1</sub> : 10 MΩ R <sub>2</sub> : 1.5 kΩ	5 times
ESD (MM)	 R <sub>1</sub> : 10 MΩ R <sub>2</sub> : 0 C: 200 pF V: ±0.2 kV	5 times
Vibration Test	20~2000~20 Hz, 200 m/s <sup>2</sup> , sweep 4 min X, Y, Z 3 direction, each 1 cycle	4 cycles
Mechanical Shock Test	1500 g, 0.5 ms 3 shocks each X-Y-Z axis	5 cycles

### b) Criteria for Judging the Damage

Item	Symbol	Test Condition (T <sub>s</sub> = 25 °C)	Limit	
			Min.	Max.
Forward Voltage	V <sub>F</sub>	I <sub>F</sub> = 350 mA	Init. Value * 0.9	Init. Value * 1.1
Luminous Flux	Φ <sub>v</sub>	I <sub>F</sub> = 350 mA	Init. Value * 0.7	Init. Value * 1.1

## 6. Soldering Conditions

### a) Reflow Conditions (Pb free)

Reflow frequency: 2 times max.

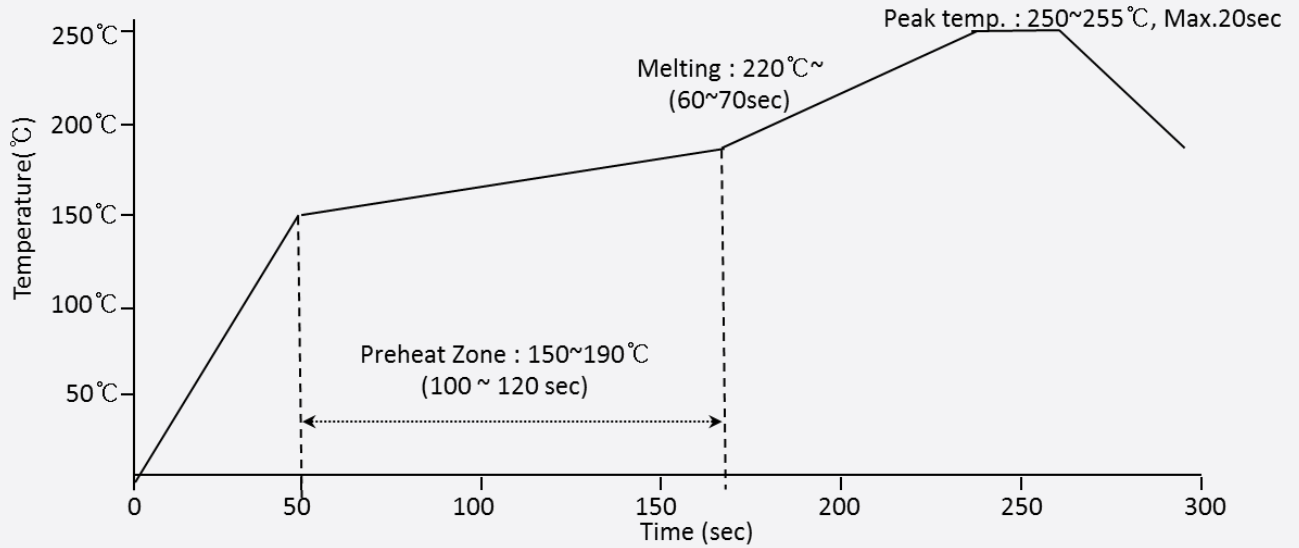

### b) Manual Soldering Conditions

No more than 5 seconds @ max. 300 °C, under soldering iron.

## 7. Tape & Reel

### a) Taping Dimension

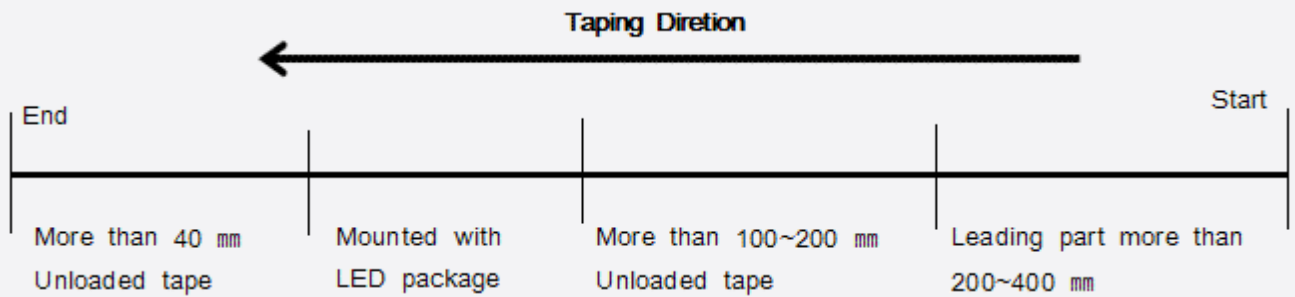
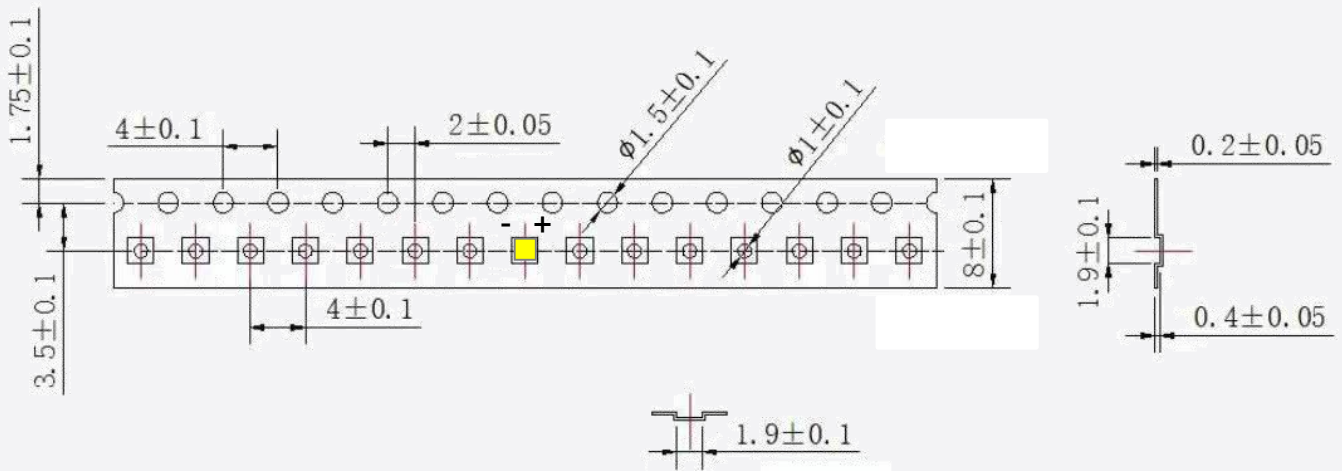



b) Reel Dimension

(unit: mm)

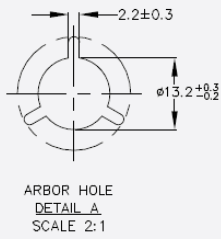
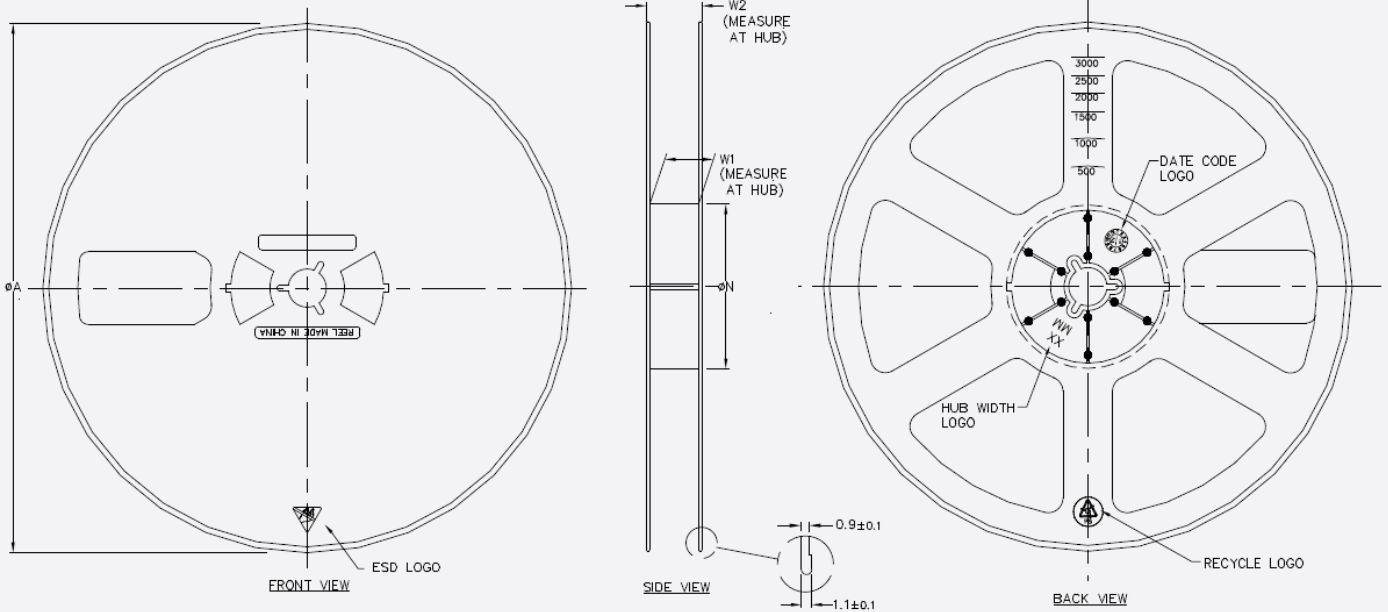

PRODUCT SPECIFICATIONS				
TAPE WIDTH	$\phi A$ $\pm 1.0$	$\phi N$ $\pm 0.5$	$W1$ $\pm 0.5$	$W2$ (MAX)
08MM	$\phi 178.0$	54.0	9.5	15.0
12MM	$\phi 178.0$	54.0	13.5	19.0

Notes:

- 1) Quantity: 4,000 Qty/reel
- 2) Cumulative tolerance: Cumulative tolerance / 10 pitches is  $\pm 0.2$  mm
- 3) Packaging: P/N, Manufacturing data code no. and quantity are indicated on the aluminum packing bag

## 8. Label Structure

### a) Label Structure

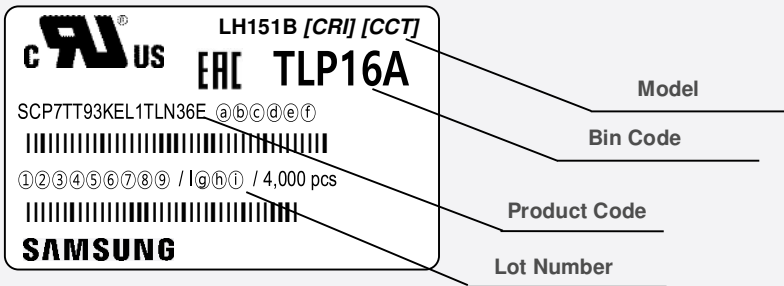

Note: Denoted product code and bin code above is only an example

Bin Code:

ⒶⒷ : Chromaticity bin (refer to page 9-10)

ⒸⒹ : Luminous Flux bin (refer to page 7)

ⒺⒾ : Forward Voltage bin (refer to page 8)

### b) Lot Number

The lot number is composed of the following characters:

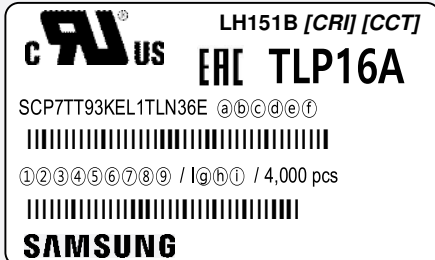

①②③④⑤⑥⑦⑧⑨ / 1ⒶⒷⒸ / 4,000 pcs

①② : Production site (GB: Nanchang China)

③ : Product state (A: Normal, B: Bulk, C: First Production, R: Reproduction, S: Sample)

④ : Year (Z: 2015, A: 2016, E:2020 ...)

⑤ : Month (1~9, A, B, C)

⑥ : Day (1~9, A, B~V)

⑦⑧⑨ : Product serial number (001 ~ 999)

⑨ⒾⒿ : Reel number (001 ~ 999) or (AAA ~ ZZZ)

## 9. Packing Structure

### a) Packing Process

Reel

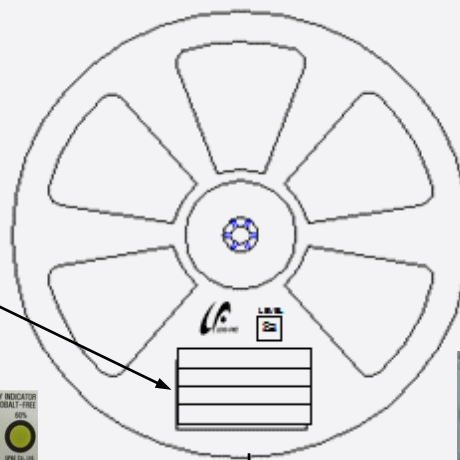
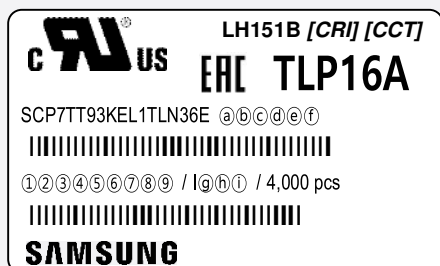

Aluminum Vinyl Bag



Outer Box

Material: Paper (SW3B(A))

Type	Size (mm)			Note
	L	W	H	
7 inch	295 ± 5	290 ± 5	260 ± 5	Max 10 reels

① Side Label

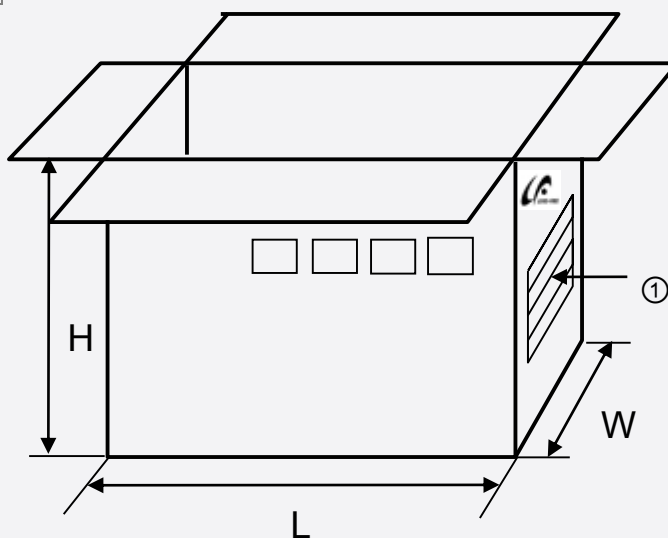
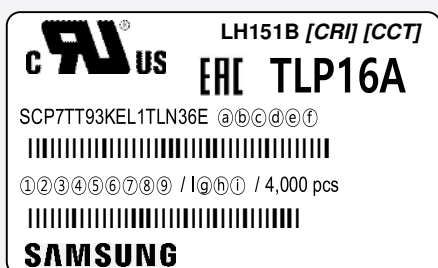

b) Aluminum Vinyl Packing Bag



**CAUTION**

This bag contains  
**MOISTURE SENSITIVE DEVICES**

**LEVEL**  
**2a**

1. Shelf life in sealed bag: 12 months at <40°C and <90% relative humidity (RH)
2. Peak package body temperature: 240 °C
3. After this bag is opened, devices that will be subjected to reflow solder or other high temperature processes must be:
  - a. Mounted within 672 hours at factory conditions of equal to or less than 30°C /60% RH, or
  - b. Stored at <10% RH
4. Devices require bake, before mounting, if:
  - a. Humidity Indicator Card is >65% when read at 23±5°C, or
  - b. 2a is not met.
5. If baking is required, devices must be baked for 1 hours at 60±5°C

Note: if device containers cannot be subjected to high temperature or shorter bake times are desired, reference IPC/JEDEC J-STD-033 for bake procedure.

Bag seal due date: \_\_\_\_\_  
(if blank, see code label)

Note: Level and body temperature by IPC/JEDEC J-STD-020

**c**  **us**      LH151B [CRI] [CCT]

**EH** **TLP16A**

SCP7TT93KEL1TLN36E @b@c@d@e@f

|||||

①②③④⑤⑥⑦⑧⑨ / I@b① / 4,000 pcs

|||||

**SAMSUNG**









**■ 주의 사항**

이 알루미늄 지퍼 백은 습기 및 정전기로부터 제품을 보호하기 위하여 제작되었습니다. 개봉 후에는 즉시 솔더 작업을 실시하는 것을 권장합니다.

습기 및 정전기로부터 제품을 보호 하기 위해서 개봉 후 사용하지 않는 자재는 본 팩에 넣어 보관 하시기 바랍니다. 사용하지 않는 자재를 본 팩에 넣을 때는 반드시 동봉된 드라이 팩과 함께 넣고 지퍼부분을 완전하게 밀봉하여 주시기 바랍니다.

**■ Important**

This Al Zipper bag is designed to protect the enclosed products from moisture and ESD. Once opened, the products should be soldered onto the printed circuit board immediately. When not in use, please do not leave the products unprotected by the Al Zipper Bag. To repack unused products., please ensure the zip-lock is completely sealed with the dry pack left inside.

c) Silica Gel & Humidity Indicator Card inside Aluminum Vinyl Bag

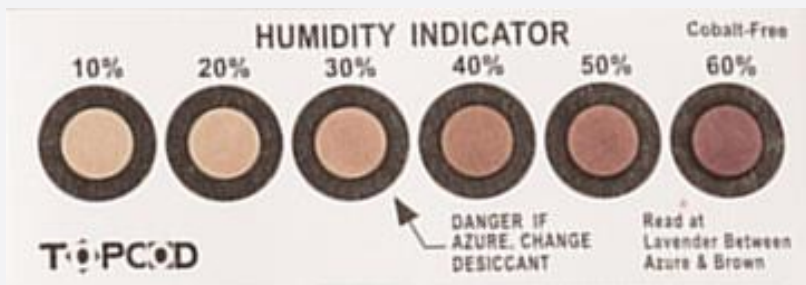

## 10. Precautions in Handling & Use

- 1) For over-current protection, users are recommended to apply resistors connected in series with the LEDs to mitigate sudden change of the forward current caused by shift of forward voltage.
- 2) This device should not be used in any type of fluid such as water, oil, organic solvent, etc. When cleaning is required, IPA is recommended as the cleaning agent. Some solvent-based cleaning agent may damage the silicone resins used in the device.
- 3) When the device is in operation, the forward current should be carefully determined considering the maximum ambient temperature and corresponding junction temperature.
- 4) LEDs must be stored in a clean environment.
- 5) After storage bag is opened, device subjected to soldering, solder reflow, or other high temperature processes must be:
  - a. Mounted within 672 hours (28 days) at an assembly line with a condition of no more than 30 °C / 60 % RH, or
  - b. Stored at <10 % RH
- 6) Repack unused devices with anti-moisture packing, fold to close any opening and then store in a dry place.
- 7) Devices require baking before mounting, if humidity card reading is >60 % at 23 ± 5 °C.
- 8) Devices must be baked for 1 hour at 60 ± 5 °C, if baking is required.
- 9) The LEDs are sensitive to the static electricity and surge current. It is recommended to use a wrist band or anti-electrostatic glove when handling the LEDs. If voltage exceeding the absolute maximum rating is applied to LEDs, it may cause damage or even destruction to LED devices. Damaged LEDs may show some unusual characteristics such as increase in leakage current, lowered turn-on voltage, or abnormal lighting of LEDs at low current.
- 10) VOCs (Volatile Organic Compounds) can be generated from adhesives, flux, hardener or organic additives used in luminaires (fixtures). Transparent LED silicone encapsulant is permeable to those chemicals and they may lead to a discoloration of encapsulant when they exposed to heat or light. This phenomenon can cause a significant loss of light emitted (output) from the luminaires. In order to prevent these problems, we recommend users to know the physical properties of materials used in luminaires and they must be carefully selected.

# Legal and additional information.

## [About Samsung Electronics Co., Ltd.](#)

Samsung Electronics Co. Ltd inspires the world and shapes the future with transformative ideas and technologies. The company is redefining the worlds of TVs, smartphones, wearable devices, tablets, digital appliances, network systems, and semiconductor and LED solutions. For the latest news, please visit the Samsung Newsroom at <http://news.samsung.com>.

Copyright © 2020 Samsung Electronics Co., Ltd. All rights reserved.  
Samsung is a registered trademark of Samsung Electronics Co., Ltd.  
Specifications and designs are subject to change without notice. Non-metric weights and measurements are approximate. All data were deemed correct at time of creation. Samsung is not liable for errors or omissions. All brand, product, service names and logos are trademarks and/or registered trademarks of their respective owners and are hereby recognized and acknowledged.

Samsung Electronics Co., Ltd.  
1, Samsung-ro  
Giheung-gu  
Yongin-si, Gyeonggi-do, 17113  
KOREA

[www.samsungled.com](http://www.samsungled.com)

**SAMSUNG**