

# PhlatLight™ PT120 Projection Chipset



## Technology Overview

Luminus Devices' Projection Technology is an innovative solid-state light source created to replace arc lamps in projection systems. Enabled by unique use of Photonic Lattice technology, PhlatLight chipsets represent a major breakthrough in brightness that delivers all the benefits of solid state light sources in projections applications:

- Wide color gamut for vivid colors, exceeds NTSC.
- Instant turn-on, no more wait time.
- High Reliability; no lamp replacement
- Environmentally friendly technology - Mercury-free.
- Electronic control of color points and light intensity on a frame by frame basis

PhlatLight products benefit from numerous innovations in the domain of packaging, thermal management and optical coupling that allow designers to achieve efficient light engine designs and deliver high screen brightness.

## Angular Intensity Distribution- Example

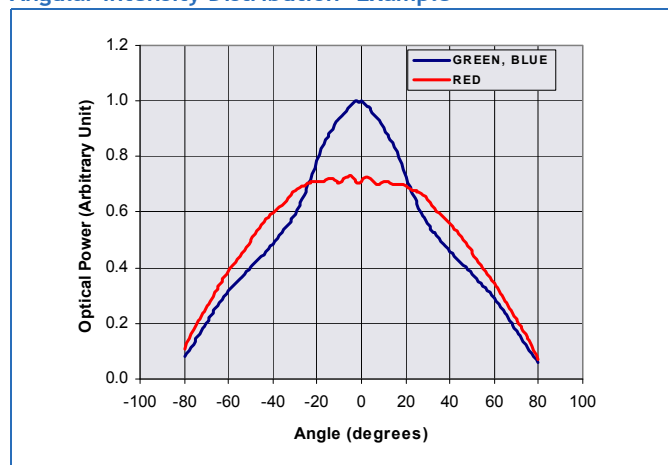

## Features

- Matched RGB Chipset with 12mm<sup>2</sup> emitting area designed for projection applications
- Photonic lattice technology for very high surface brightness
- 100% surface emission for high collection efficiency and low optical losses
- Wide color gamut: RED 623 nm, GREEN 525 nm, BLUE 462 nm, EP Blue 460nm typical dominant wavelength
- Single emitting area per color allows for collection with single lens for simplified optics
- 16:9 aspect ratio matched with micro-display and screen aspect ratio
- Thermally efficient Type CX Common Anode package
- RoHS (lead-free) compliant

## Applications

- Specifically engineered for Rear-Projection Displays, front projectors, head-up projection displays
- Optimized for Micro-Display diagonal sizes ranging from 0.65" to 0.95" with 16:9 aspect ratio.
- Suitable for DLP™ (e.g. xHD5, 0.65", 0.95" 1080p), LCoS, HTPS and 3LCD microdisplays

## Optical and Electrical Characteristics

	Symbol	Red	Green	Blue	EP-Blue <sup>1</sup> Preliminary	Unit
Bin Kit		MPB	MPB	MPB	EPA	
Emitting Area		11.96	11.96	11.96	11.96	mm <sup>2</sup>
Emitting Area Dimensions		4.6x2.6	4.6x2.6	4.6x2.6	4.6x2.6	mmxmm
<b>Characteristics at recommended Pulsed Drive Current <math>I_F^{2,3}</math></b>						
Reference Duty Cycle <sup>4</sup>		25	50	25	25	%
Recommended Peak Drive Current <sup>5</sup>	typ $I_F$	30	30	30	30	A
Peak Luminous Flux <sup>6</sup>	typ $\Phi_v$	1800	3500	600	750	lm
Peak Radiometric Power	typ $\Phi_r$	10.4	7.3	12.1	16.3	W
Dominant Wavelength	$\lambda_{dmin}$	619	516	455	450	nm
	typ $\lambda_d$	623	525	462	460	nm
	$\lambda_{dmax}$	630	535	469	468	nm
FWHM - Spectral bandwidth at 50% of $\Phi_v$	typ $\Delta\lambda_d$	19	39	20	20	nm
Color Saturation <sup>7,8</sup>	typ	1.00	0.79	0.99	0.99	
Chromaticity Coordinates <sup>7,8</sup>	typ x	0.697	0.171	0.144	0.154	
	typ y	0.303	0.702	0.040	0.024	
Forward Voltage	min $V_{Fmin}$	2.2	3.5	3.5	3.2	V
	typ $V_F$	2.6	4.9	4.9	4.0	V
	max $V_{Fmax}$	3.4	5.9	5.9	5.2	V
Dynamic Resistance	typ $\Omega_{dyn}$	0.02	0.03	0.02	0.02	$\Omega$
<b>Device Thermal Characteristics and Lifetime</b>						
Thermal Coefficient of Photometric Flux	typ	-1.1	-0.2	-0	-0	% / °C
Thermal Coefficient of Radiometric Flux	typ	-0.7	-0.2	-0.2	-0.2	% / °C
Forward Voltage Temperature Coefficient	typ	-3.0	-3.0	-3.0	-3.0	mV / °C
Median Lifetime <sup>9</sup>		>60,000	>60,000	>60,000	>60,000	Hours

## Optical and Electrical Characteristics

	Symbol	Red	Green	Blue	EP-Blue <sup>1</sup> Preliminary	Unit
Characteristics at Reference Continuous Drive Current $I_F$ (Continuous Waveform) <sup>2</sup>						
Reference Drive Current	typ $I_F$	18	18	18	18	A
Luminous Flux	typ $\Phi_v$	1010	2450	435	540	lm
Radiometric Flux	typ $\Phi_r$	5.8	4.7	8.0	10.8	W
Dominant Wavelength	typ $\lambda_d$	624	528	464	462	nm
Color Saturation <sup>7,8</sup>	typ	1.00	0.83	0.99	0.99	
FWHM - Spectral bandwidth at 50% of $\Phi_v$	typ $\Delta\lambda_d$	18	38	21	21	nm
	typ x	0.698	0.183	0.141	0.153	
Chromaticity Coordinates <sup>7,8</sup>	typ y	0.301	0.703	0.044	0.025	
	min $V_{Fmin}$	2.0	3.1	3.1	2.8	V
Forward Voltage	typ $V_F$	2.3	4.4	4.4	3.6	V
	max $V_{Fmax}$	3.0	5.3	5.3	4.6	V
Dynamic Resistance	typ $\Omega_{dyn}$	0.02	0.03	0.02	0.05	$\Omega$

Note 1: EP-Blue is recommended for new designs. Please see page 9 for part ordering numbers.

Note 2: All ratings are based on operation with a constant heat sink temperature  $T_{hs} = 40^\circ\text{C}$ . See Thermal Resistance section for  $T_{hs}$  definition.

Note 3: Parameters rated at typical duty cycle and Pulsed operation frequency  $f > 240\text{Hz}$ ;

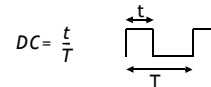

Note 4: Duty Cycle used to specify device ratings under Pulsed operation. PhlatLight devices can operate at duty cycles ranging from 1% to 100%. At higher duty cycles, drive current should be adjusted to maintain the junction temperature at desired levels to meet the application lifetime requirements.

Note 5: In pulsed operation, rise time from 10 to 90% of forward current should be larger than 0.5 microseconds.

Note 6: For Blue and EP-Blue devices, total flux from emitting area at typical dominant wavelength at recommended peak drive current conditions.

Note 7: In CIE 1931 chromaticity diagram coordinates, normalized to  $X+Y+Z=1$

Note 8: For Reference only

Note 9: Assuming  $T_j < 80^\circ\text{C}$  for Red devices and  $T_j < 115^\circ\text{C}$  for Blue devices and  $T_j < 125^\circ\text{C}$  for Green devices

### Absolute Maximum Ratings

	Symbol	Red	Green	Blue	EP-Blue	Unit
Maximum Current <sup>1,2</sup>	Max	36	36	36	36	A
Maximum Operating Junction Temperature <sup>3</sup>	Max $T_{jmax}$	110	170	170	170	°C
Storage Temperature Range		-40/+100	-40/+100	-40/+100	-40/+100	°C

Note 1: Luminus PhlatLight LEDs are designed for operation to an absolute maximum forward drive current density of 2.5A/mm<sup>2</sup> cw, and 3A/mm<sup>2</sup> pulsed (f>240Hz, duty cycle < 60%). Please refer to absolute maximum rating table above for specific absolute maximum currents for the products covered in this datasheet. Product lifetime data is specified at recommended forward drive currents. Sustained operation at absolute maximum currents will result in a reduction of device lifetime compared to recommended forward drive currents. Actual device lifetimes will also depend on junction temperature. Refer to the lifetime derating curves (available from Luminus) for further information.

Note 2: In pulsed operation, rise time from 10 to 90% of forward current should be larger than 0.5 microseconds.

Note 3: Sustained operation at Maximum Operating Junction Temperature ( $T_{jmax}$ ) will result in reduced device life time.

### Luminous Flux variation with Wavelength: $\Phi_v = f(\lambda_d)$ at Recommended Operating Current $I_F$

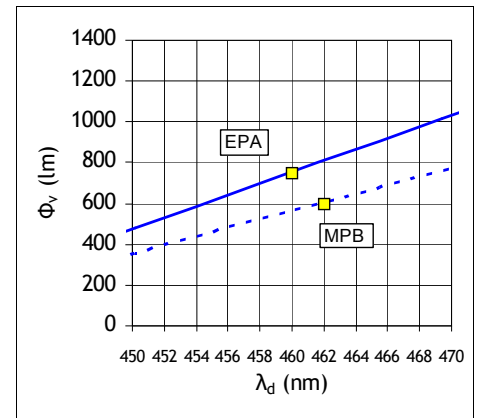
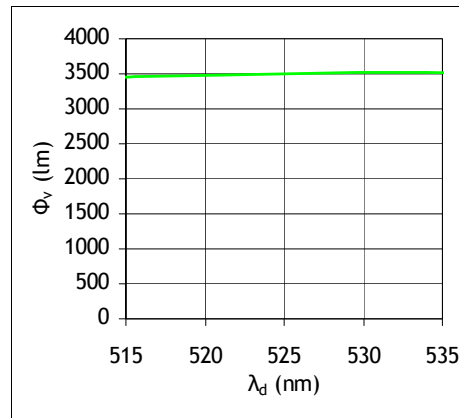
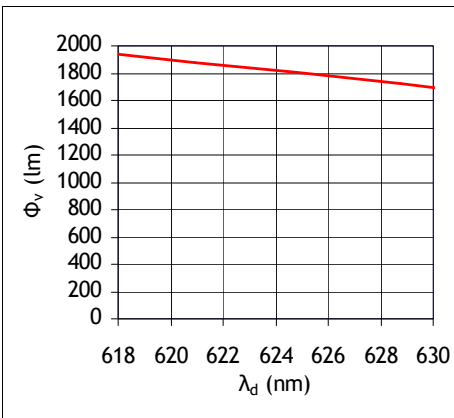

See note 1 on page 6.

**Luminous Flux variation with Drive Current -  $\Phi_v = f(I_F)$  - Typical**

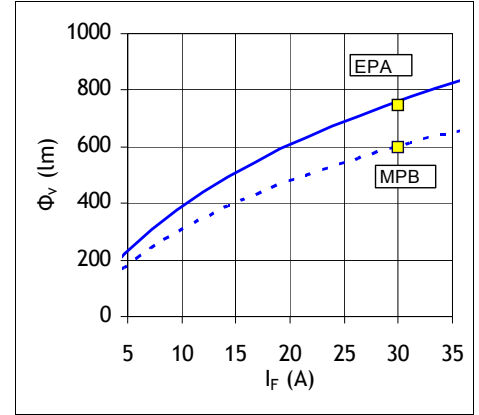
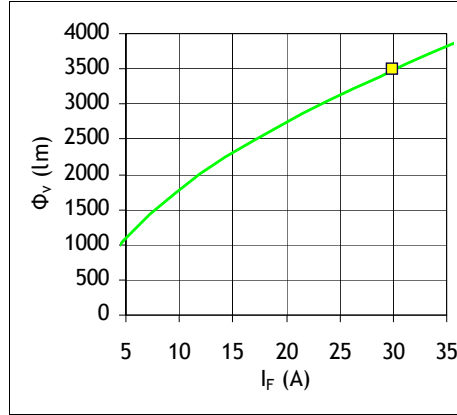
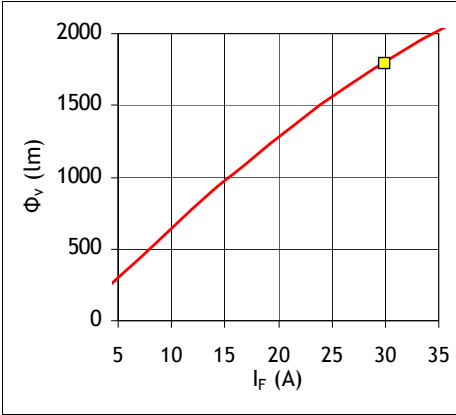

See notes 1,2 on page 6.

**Dominant Wavelength variation with Forward Current -  $\lambda_d = f(I_F)$  - Typical**

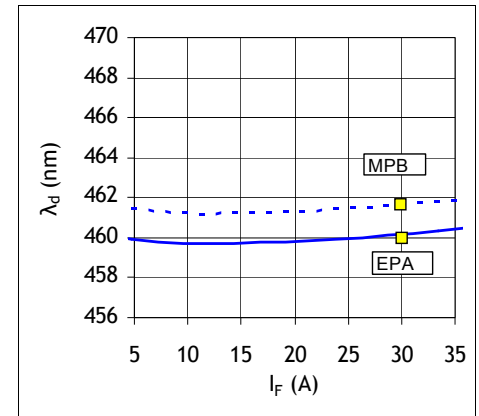
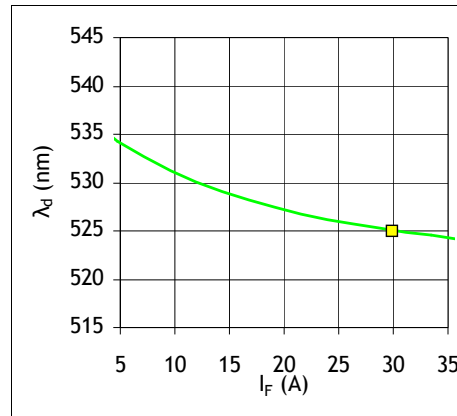
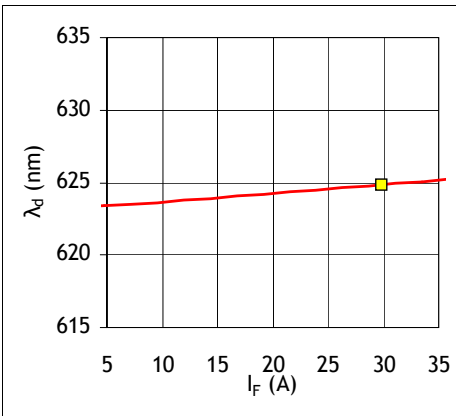

See notes 1,2 on page 6.

**Forward Voltage variation with Drive current -  $V_F = f(I_F)$  - Typical**

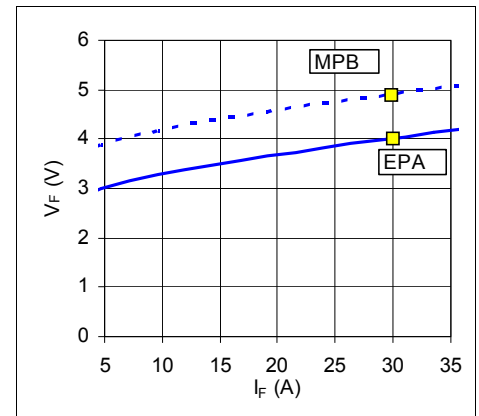
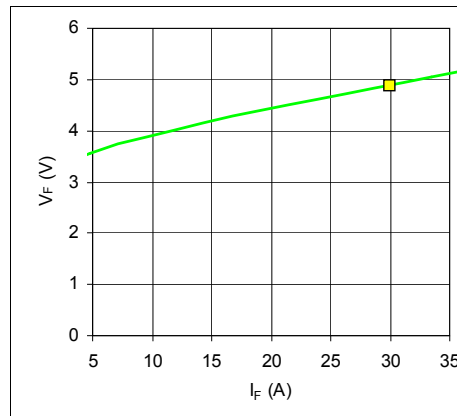
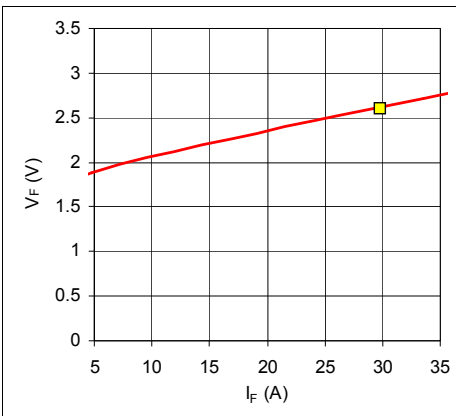

See notes 1,2 on page 6.

### Optical Spectrum (Typical)

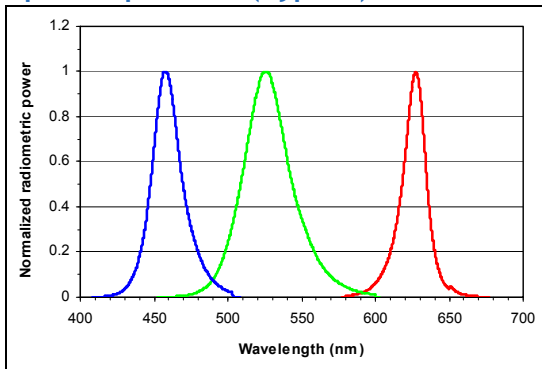

See note 3 on page 6.

### Chart Notes

- Note 1:** For Pulsed operation, typical RGB duty cycles used are 25%, 50% and 25% respectively for pulsed operation ( $T_{hs} = 40^{\circ}\text{C}$ ).
- Note 2:** Yellow square indicate device operating point under recommended conditions listed in the Optical and Electrical Characteristics table.
- Note 3:** Typical Spectrum at recommended peak drive current.

## Thermal Resistance

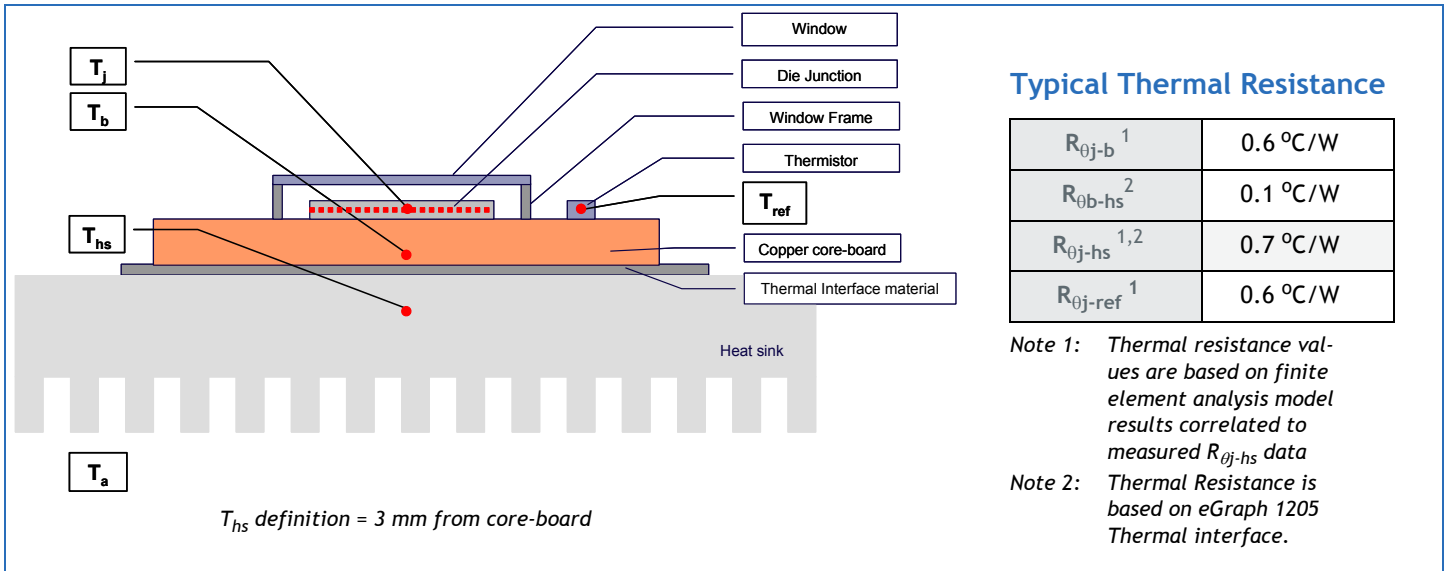

## Thermistor Information

The thermistor used in PhlatLight™ devices mounted on core-boards is from Murata Manufacturing Co. The global part number is NCP15XH103J03RC. Please see <http://www.murata.com/> or <http://www.murata.co.jp> for details on calculating thermistor temperature.

## Electrical Pinout

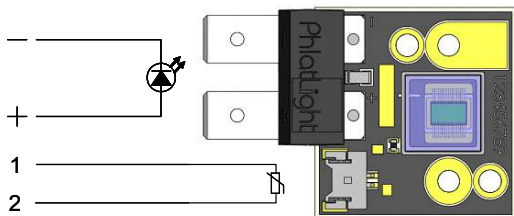

Mechanical Dimensions

Package: Type CX

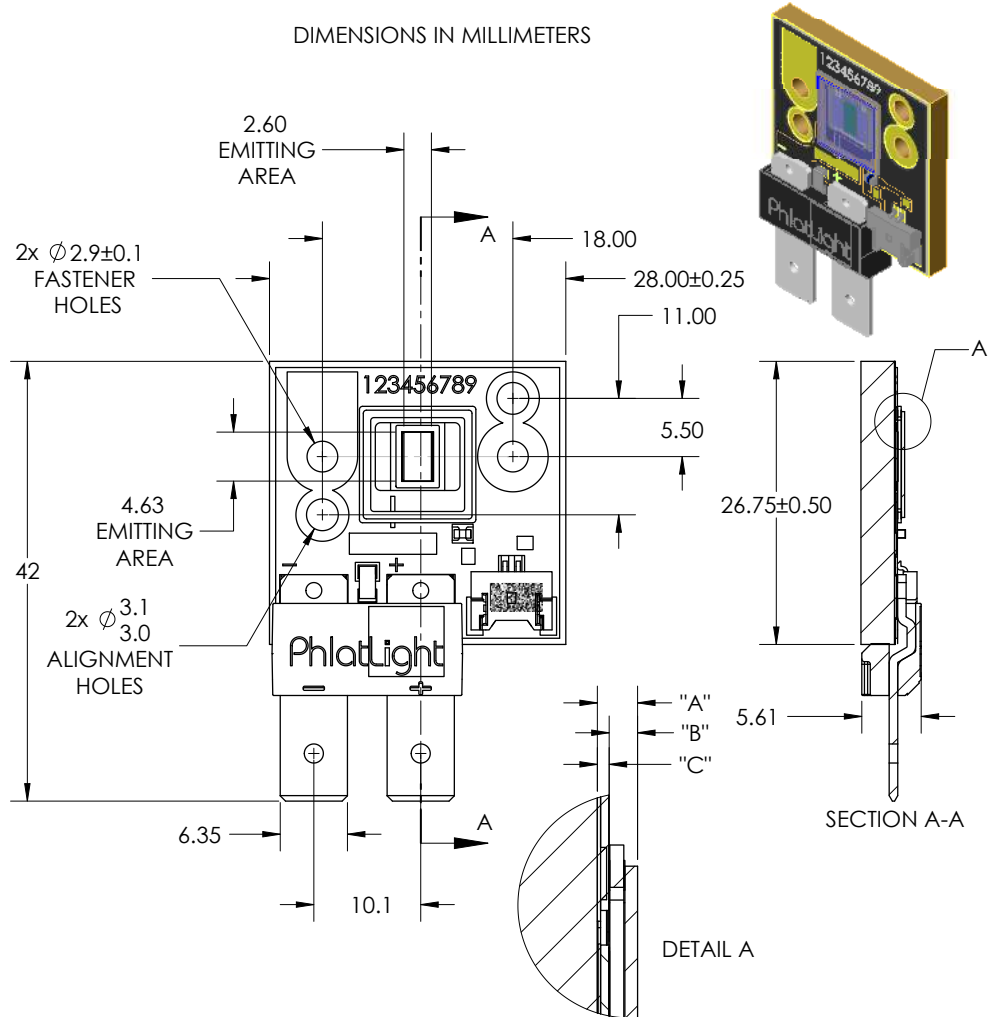

DIMENSION NAME	DESCRIPTION	NOMINAL DIMENSION	TOLERANCE
"A"	TOP OF METAL SUBSTRATE TO TOP OF GLASS	0.95	±0.13
"B"	EMITTING AREA TO TOP OF GLASS	0.67	±0.16
"C"	TOP OF METAL SUBSTRATE TO EMITTING AREA	0.28	±0.05

Recommended connector for Anode and Cathode: Panduit Disco Lok™ Series P/N: DNG14-250FL-C or equivalent  
 Thermistor Connector: MOLEX P/N 53780-0270. Recommended Female: MOLEX P/N 51146-0200 or equivalent  
 For detailed drawing of the PT120 Type CX package, please refer to the DWG-001124 document



## Ordering Information

Device Part Number	Color	Description
PT-120-R-C11-MPB	Red	Bin Kit MPB Red PhlatLight PT120 device consisting of a 12mm <sup>2</sup> LED, thermistor and connector mounted on a type CX copper-core PCB
PT-120-G-C11-MPB	Green	Bin Kit MPB Green PhlatLight PT120 device consisting of a 12mm <sup>2</sup> LED, thermistor and connector mounted on a type CX copper-core PCB
PT-120-B-C11-MPB <sup>1</sup>	Blue	Bin Kit MPB Blue PhlatLight PT120 device consisting of a 12mm <sup>2</sup> LED, thermistor and connector mounted on a type CX copper-core PCB
PT-120-B-C11-EPA <sup>2</sup>	EP-Blue	Bin Kit EPA Blue PhlatLight PT120 device consisting of a 12mm <sup>2</sup> LED, thermistor and connector mounted on a type CX copper-core PCB

Note 1: *Not recommended for new designs*

Note 2: *Bin Kit EPA Blue is recommended for new designs.*

[www.luminus.com](http://www.luminus.com)

The products, their specifications and other information appearing in this document are subject to change by Luminus Devices without notice. Luminus Devices assumes no liability for errors that may appear in this document, and no liability otherwise arising from the application or use of the product or information contained herein. None of the information provided herein should be considered to be a representation of the fitness or suitability of the product for any particular application or as any other form of warranty. Luminus Devices' product warranties are limited to only such warranties as accompany a purchase contract or purchase order for such products. Nothing herein is to be construed as constituting an additional warranty. No information contained in this publication may be considered as a waiver by Luminus Devices of any intellectual property rights that Luminus Devices may have in such information. PhlatLight<sup>®</sup> is a registered trademark of Luminus Devices, Inc., all rights reserved.

This product is protected by U.S. Patents 6,831,302; 7,074,631; 7,083,993; 7,084,434; 7,098,589; 7,105,861; 7,138,666; 7,166,870; 7,166,871; 7,170,100; 7,196,354; 7,211,831; 7,262,550; 7,274,043; 7,301,271; 7,341,880; 7,344,903; 7,345,416; 7,348,603; 7,388,233; 7,391,059 Patents Pending in the U.S. and other countries.