

CPDVR103V3U-HF

RoHS Device

Halogen Free



Features

- Ultra-low capacitance.
- IEC 61000-4-2 (Air): $\pm 15\text{kV}$
IEC 61000-4-2 (Contact): $\pm 15\text{kV}$
IEC 61000-4-5 (Surge): 6A (8/20 μs)

Mechanical data

- Case: DFN2510-10L package, molded plastic.
- Mounting position: Any.

Circuit Diagram

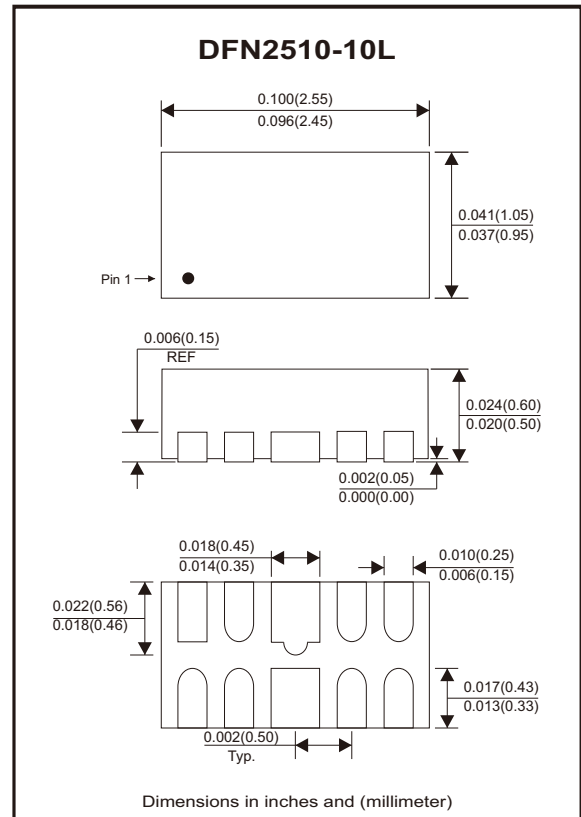
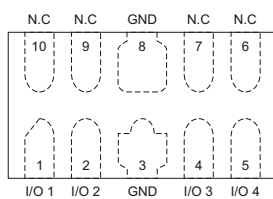
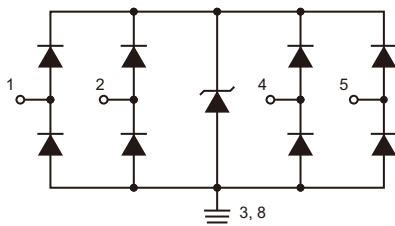

Maximum Rating (at Ta=25°C unless otherwise noted)

Parameter	Conditions	Symbol	Value	Unit
Electrostatic discharge voltage	IEC 61000-4-2; contact discharge	V _{ESD}	± 15	kV
	IEC 61000-4-2; air discharge		± 15	kV
Peak pulse current	IEC 61000-4-5; tp = 8/20 μs	I _{PP}	6	A
Operating junction temperature range		T _J	-40 to +125	°C
Storage temperature range		T _{STG}	-55 to +150	°C

Electrical Characteristics (at Ta=25°C unless otherwise noted)

Parameter	Conditions	Symbol	Min	Typ	Max	Unit
Reverse working voltage		V_{RWM}			3.3	V
Triggering voltage	$I_{t1} = 1\text{mA}$; Any I/O to GND	V_{t1}	3.6			V
Holding voltage	$I_h = 100\text{mA}$; Any I/O to GND	V_h	0.8			V
Reverse leakage current	$V_{RWM} = 3.3\text{V}$; Any I/O to GND	I_R		10	50	nA
Surge clamping voltage ($t_p = 8/20\mu\text{s}$)	$I_{PP} = 6\text{A}$; Any I/O Pin to GND	V_C			7.5	V
TLP clamping voltage ($t_p = 10/100\text{ns}$)	$I_{PP} = 16\text{A}$; Any I/O Pin to GND	V_C		7.0		V
Dynamic resistance $t_p = 10/100\text{ns}$, $t_r = 1\text{ns}$	I/O Pin to GND	R_{DYN}		0.35		Ω
Junction capacitance	$V_R = 0\text{V}$, $f = 1\text{MHz}$, I/O to GND	C_J		0.3	0.6	pF

Rating and Characteristic Curves (CPDVR103V3U-HF)

Fig.1 - Positive Clamping Voltage (TLP)

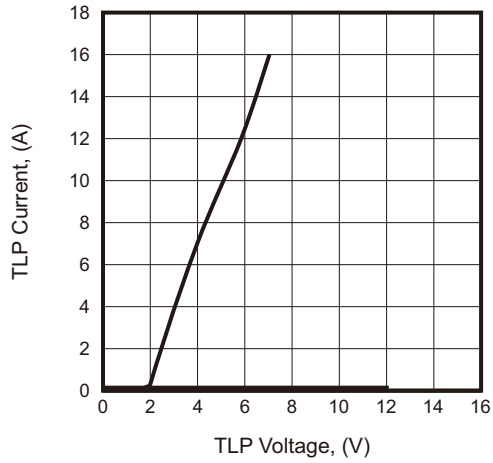

Fig.2 - Junction Capacitance

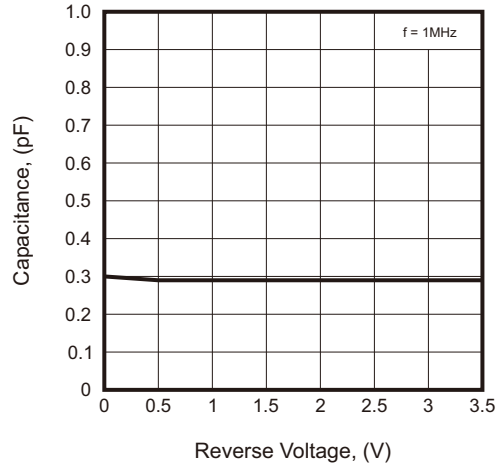

Fig.3 - IEC 61000-4-5 Test Waveform

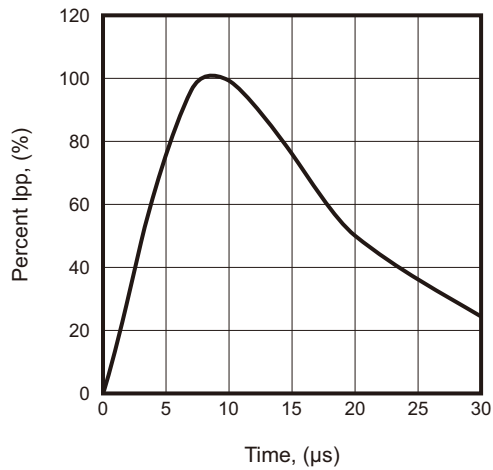

Fig.4 - Surge Clamping Voltage (IEC 61000-4-5)

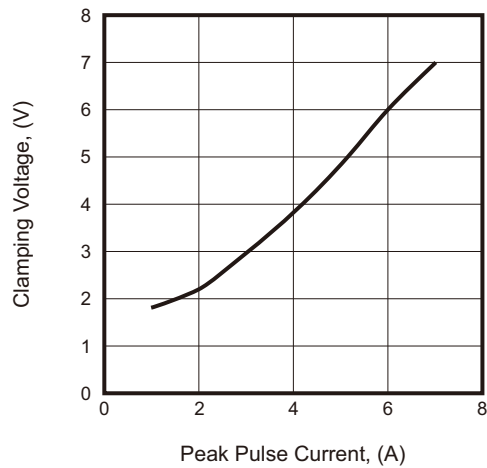

Fig.5 - Insertion Loss S21 of I/O to GND

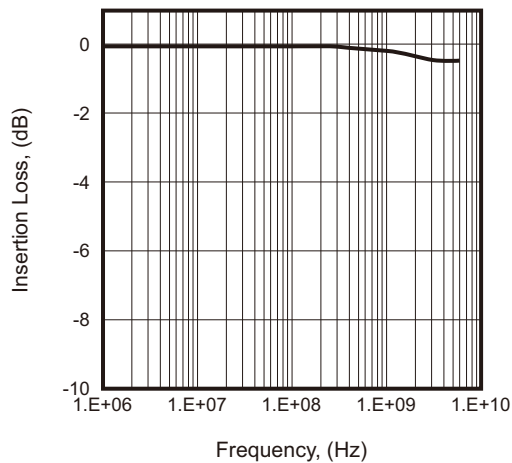
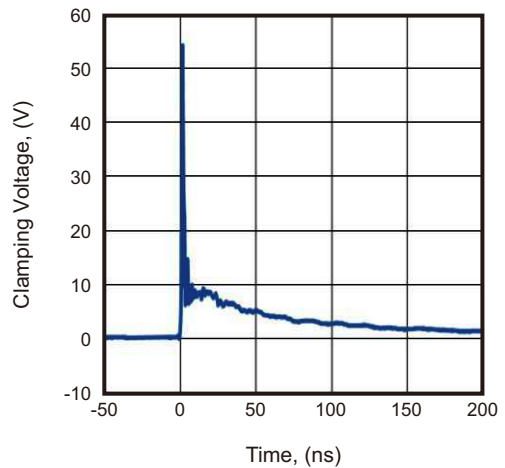
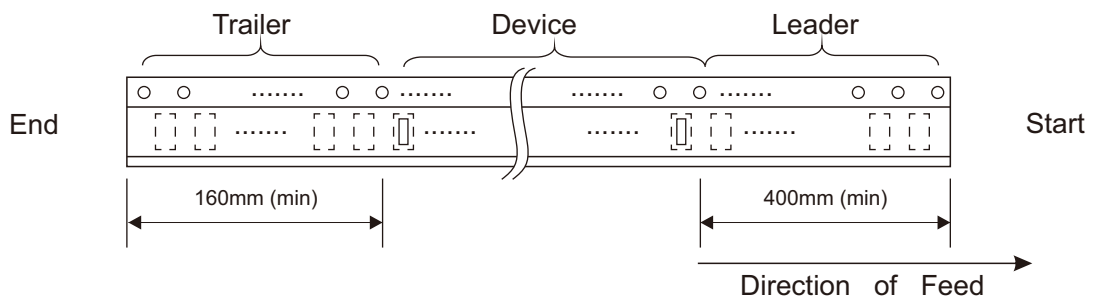
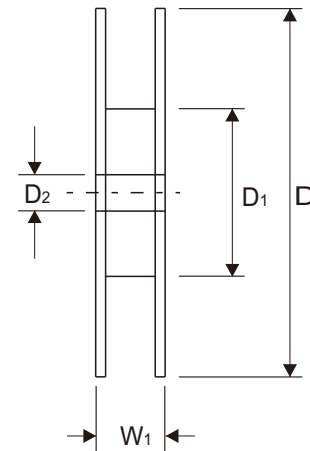
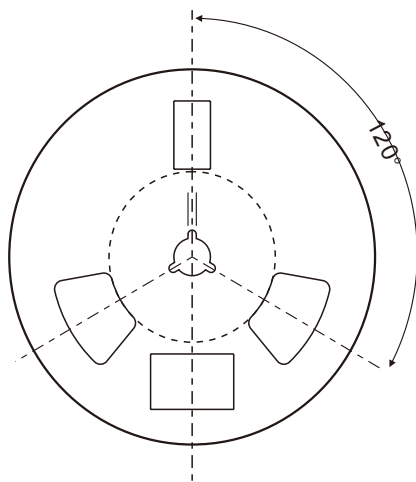
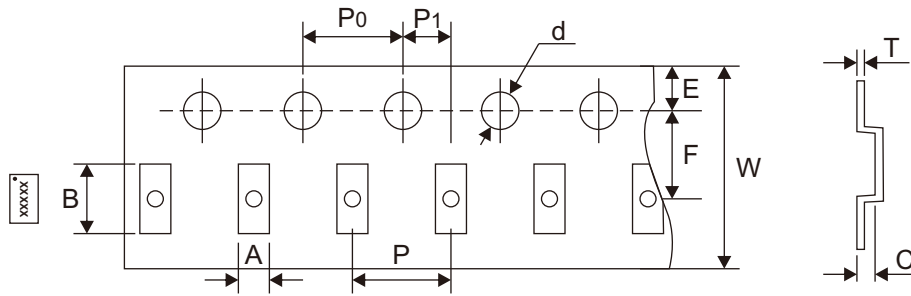

Fig.6 - ESD Clamping of I/O to GND (+8kV Contact per IEC 61000-4-2)



Reel Taping Specification



DFN2510-10L	SYMBOL	A	B	C	d	D	D1	D2
	(mm)	1.20 ± 0.05	2.70 ± 0.05	0.72 ± 0.05	1.55 + 0.10	178 ± 2.00	60.00 ± 1.00	13.20 ± 0.30
	(inch)	0.047 ± 0.002	0.106 ± 0.002	0.028 ± 0.002	0.061 + 0.004	7.008 ± 0.079	2.362 ± 0.039	0.520 ± 0.012

DFN2510-10L	SYMBOL	E	F	P	P0	P1	T	W	W1
	(mm)	1.75 ± 0.10	3.50 ± 0.05	4.00 ± 0.05	4.00 ± 0.10	2.00 ± 0.05	0.20 ± 0.03	8.00 + 0.30 - 0.10	11.40 Max
	(inch)	0.069 ± 0.004	0.138 ± 0.002	0.157 ± 0.002	0.157 ± 0.004	0.079 ± 0.002	0.008 ± 0.001	0.315 + 0.012 - 0.004	0.449 Max

Company reserves the right to improve product design, functions and reliability without notice.

REV:A

Marking Code

Part Number	Marking Code
CPDVR103V3U-HF	Xa

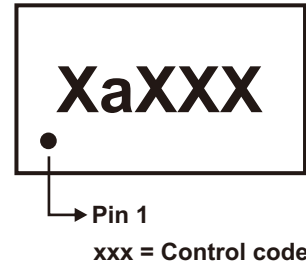

Suggested P.C.B. PAD Layout

SIZE	DFN2510-10L	
	(mm)	(inch)
A	0.20	0.008
B	0.20	0.008
C	0.40	0.016
D	0.50	0.020
E	0.675	0.027
F	0.875	0.034
G	1.00	0.039
H	1.55	0.061

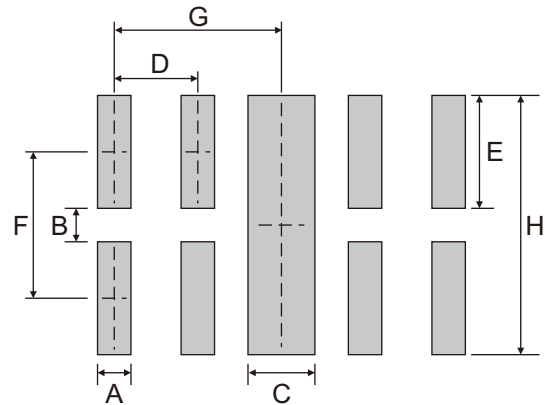

Note: 1.The pad layout is for reference purposes only.

Standard Packaging

Case Type	REEL PACK	
	REEL (pcs)	Reel Size (inch)
DFN2510-10L	3,000	7