

## REPETITIVE AVALANCHE AND $dv/dt$ RATED HEXFET<sup>®</sup> TRANSISTORS THRU-HOLE (TO-204AA/AE)

## IRFAF40 900V, N-CHANNEL

### Product Summary

Part Number	BVDSS	RDS(on)	ID
IRFAF40	900V	2.5Ω	4.3A

The HEXFET<sup>®</sup> technology is the key to International Rectifier's advanced line of power MOSFET transistors. The efficient geometry and unique processing of this latest "State of the Art" design achieves: very low on-state resistance combined with high transconductance; superior reverse energy and diode recovery  $dv/dt$  capability.

The HEXFET transistors also feature all of the well established advantages of MOSFETs such as voltage control, very fast switching, ease of paralleling and temperature stability of the electrical parameters.

They are well suited for applications such as switching power supplies, motor controls, inverters, choppers, audio amplifiers and high energy pulse circuits.



### Features:

- Repetitive Avalanche Ratings
- Dynamic  $dv/dt$  Rating
- Hermetically Sealed
- Simple Drive Requirements
- Ease of Paralleling

### Absolute Maximum Ratings

	Parameter		Units
ID @ VGS = 0V, TC = 25°C	Continuous Drain Current	4.3	A
ID @ VGS = 0V, TC = 100°C	Continuous Drain Current	2.7	
IDM	Pulsed Drain Current ①	17	
PD @ TC = 25°C	Max. Power Dissipation	125	W
	Linear Derating Factor	1.0	W/°C
VGS	Gate-to-Source Voltage	±20	V
EAS	Single Pulse Avalanche Energy ②	530	mJ
IAR	Avalanche Current ①	4.3	A
EAR	Repetitive Avalanche Energy ①	12.5	mJ
dv/dt	Peak Diode Recovery $dv/dt$ ③	1.5	V/ns
TJ	Operating Junction	-55 to 150	°C
TSTG	Storage Temperature Range		
	Lead Temperature	300 (0.063 in. (1.6mm) from case for 10s)	
	Weight	11.5(typical)	g

For footnotes refer to the last page

**Electrical Characteristics @ T<sub>j</sub> = 25°C (Unless Otherwise Specified)**

	Parameter	Min	Typ	Max	Units	Test Conditions
BVDSS	Drain-to-Source Breakdown Voltage	900	—	—	V	V <sub>GS</sub> = 0V, I <sub>D</sub> = 1.0mA
ΔBVDSS/ΔT <sub>J</sub>	Temperature Coefficient of Breakdown Voltage	—	1.2	—	V/°C	Reference to 25°C, I <sub>D</sub> = 1.0mA
RDS(on)	Static Drain-to-Source On-State Resistance	—	—	2.5	Ω	V <sub>GS</sub> = 10V, I <sub>D</sub> = 2.7A④
		—	—	2.9		V <sub>GS</sub> = 10V, I <sub>D</sub> = 4.3A ④
VGS(th)	Gate Threshold Voltage	2.0	—	4.0	V	V <sub>DS</sub> = V <sub>GS</sub> , I <sub>D</sub> = 250μA
g <sub>fs</sub>	Forward Transconductance	3.6	—	—	S (Ω)	V <sub>DS</sub> > 15V, I <sub>DS</sub> = 2.7A ④
IDSS	Zero Gate Voltage Drain Current	—	—	25	μA	V <sub>DS</sub> = 720V, V <sub>GS</sub> = 0V
		—	—	250		V <sub>DS</sub> = 720V V <sub>GS</sub> = 0V, T <sub>J</sub> = 125°C
IGSS	Gate-to-Source Leakage Forward	—	—	100	nA	V <sub>GS</sub> = 20V
IGSS	Gate-to-Source Leakage Reverse	—	—	-100		V <sub>GS</sub> = -20V
Q <sub>g</sub>	Total Gate Charge	53	—	120	nC	V <sub>GS</sub> = 10V, I <sub>D</sub> = 4.3A V <sub>DS</sub> = 450V
Q <sub>gs</sub>	Gate-to-Source Charge	4.8	—	11		
Q <sub>gd</sub>	Gate-to-Drain ('Miller') Charge	30	—	68		
t <sub>d(on)</sub>	Turn-On Delay Time	—	—	24	ns	V <sub>DD</sub> = 400V*, I <sub>D</sub> = 4.3A, R <sub>G</sub> = 9.1Ω
t <sub>r</sub>	Rise Time	—	—	39		
t <sub>d(off)</sub>	Turn-Off Delay Time	—	—	170		
t <sub>f</sub>	Fall Time	—	—	44		
L <sub>S</sub> + L <sub>D</sub>	Total Inductance	—	6.1	—	nH	Measured from drain lead (6mm/0.25in. from package) to source lead (6mm/0.25in. from package)
C <sub>iss</sub>	Input Capacitance	—	1500	—	pF	V <sub>GS</sub> = 0V, V <sub>DS</sub> = 25V f = 1.0MHz
C <sub>oss</sub>	Output Capacitance	—	190	—		
C <sub>rss</sub>	Reverse Transfer Capacitance	—	72	—		

\* Equipment Limitation

**Source-Drain Diode Ratings and Characteristics**

	Parameter	Min	Typ	Max	Units	Test Conditions
I <sub>S</sub>	Continuous Source Current (Body Diode)	—	—	4.3	A	
I <sub>SM</sub>	Pulse Source Current (Body Diode) ①	—	—	17		
V <sub>SD</sub>	Diode Forward Voltage	—	—	1.8	V	T <sub>J</sub> = 25°C, I <sub>S</sub> = 4.3A, V <sub>GS</sub> = 0V ④
t <sub>rr</sub>	Reverse Recovery Time	—	—	1100	nS	T <sub>J</sub> = 25°C, I <sub>F</sub> = 4.3A, di/dt ≤ 100A/μs
QRR	Reverse Recovery Charge	—	—	6.7	μC	V <sub>DD</sub> ≤ 50V ④
t <sub>on</sub>	Forward					

**Thermal Resistance**

	Parameter	Min	Typ	Max	Units	Test Conditions
R <sub>thJC</sub>	Junction to Case	—	—	1.0	°C/W	Typical socket mount
R <sub>thJA</sub>	Junction to Ambient	—	—	30		

For footnotes refer to the last page

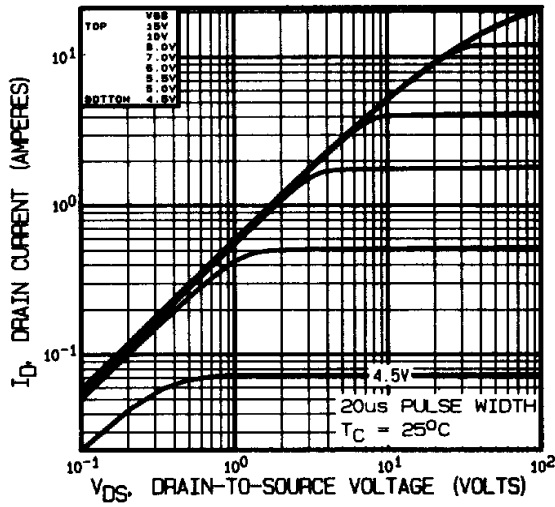

Fig 1. Typical Output Characteristics

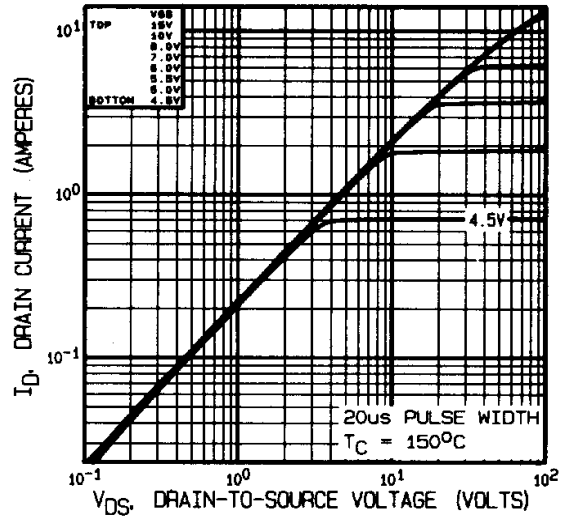

Fig 2. Typical Output Characteristics

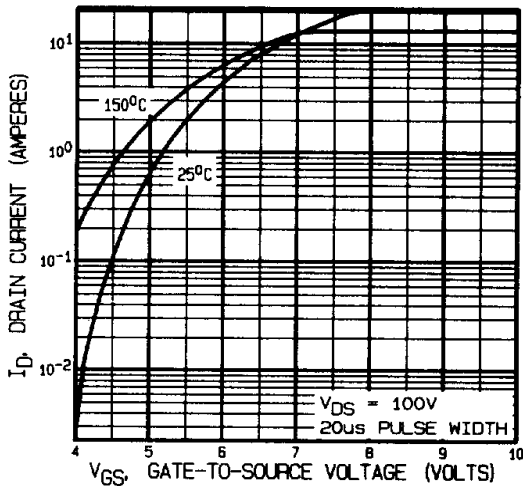

Fig 3. Typical Transfer Characteristics

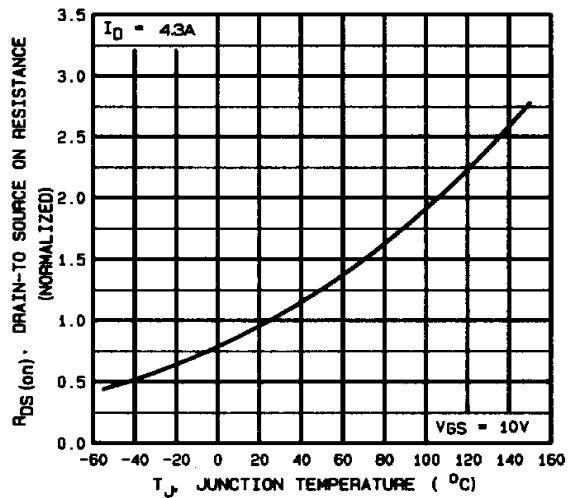
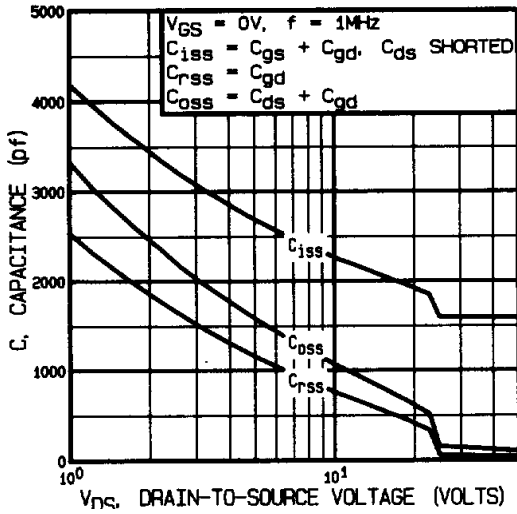
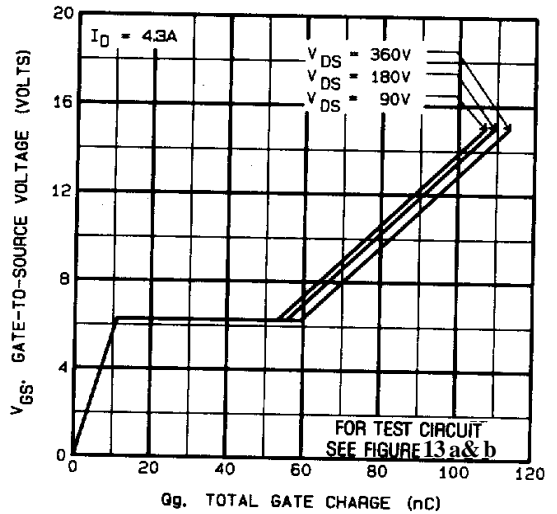

Fig 4. Normalized On-Resistance Vs. Temperature



**Fig 5.** Typical Capacitance Vs. Drain-to-Source Voltage



**Fig 6.** Typical Gate Charge Vs. Gate-to-Source Voltage

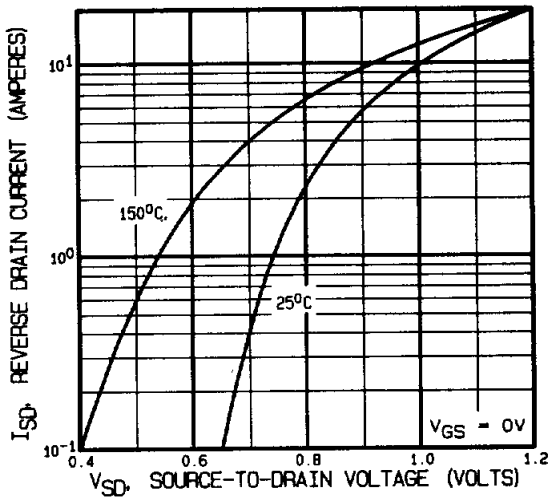

**Fig 7.** Typical Source-Drain Diode Forward Voltage

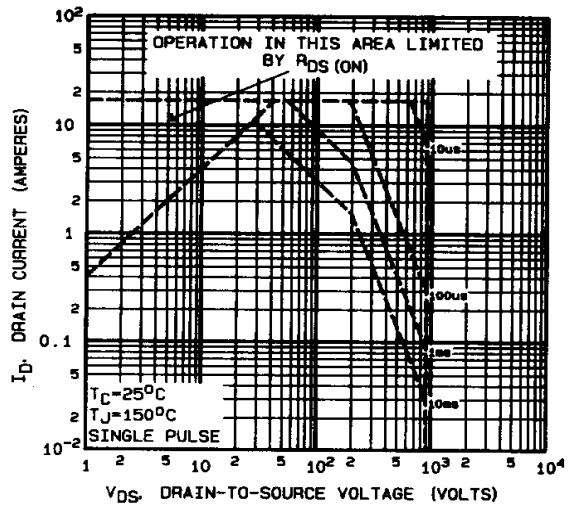

**Fig 8.** Maximum Safe Operating Area

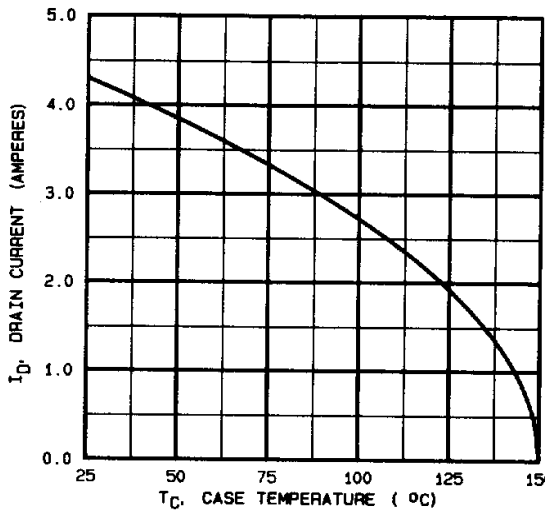

Fig 9. Maximum Drain Current Vs. Case Temperature

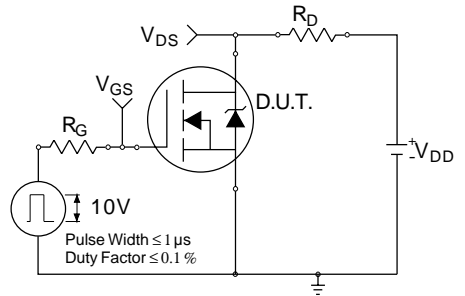

Fig 10a. Switching Time Test Circuit

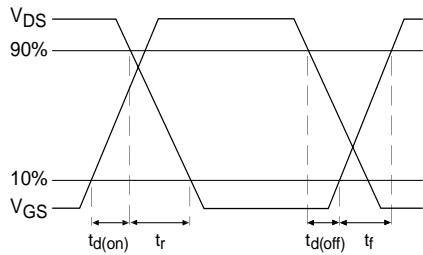

Fig 10b. Switching Time Waveforms

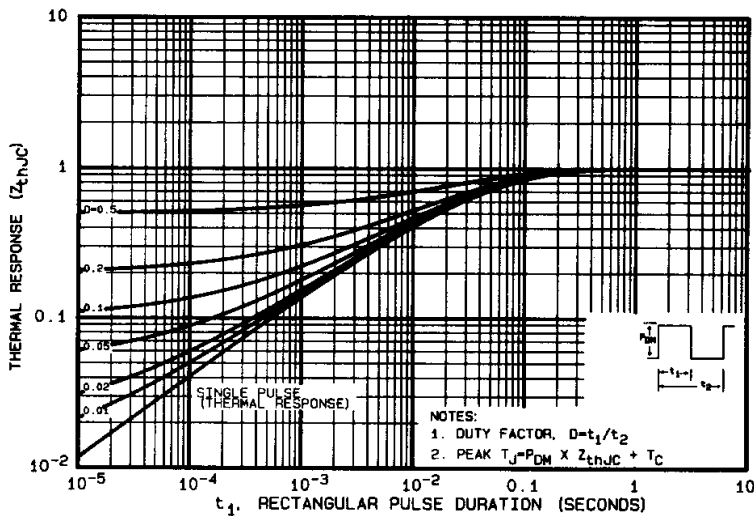

Fig 11. Maximum Effective Transient Thermal Impedance, Junction-to-Case

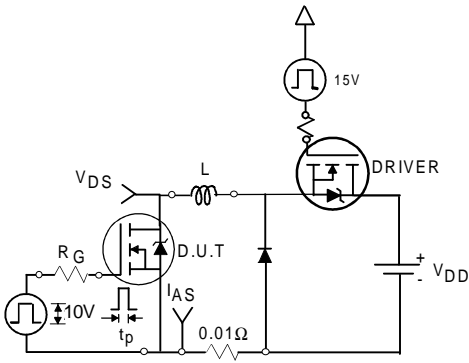

Fig 12a. Unclamped Inductive Test Circuit

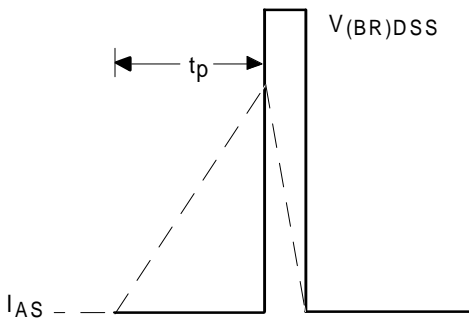

Fig 12b. Unclamped Inductive Waveforms

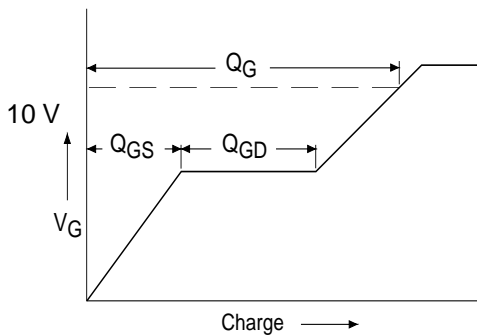

Fig 13a. Basic Gate Charge Waveform

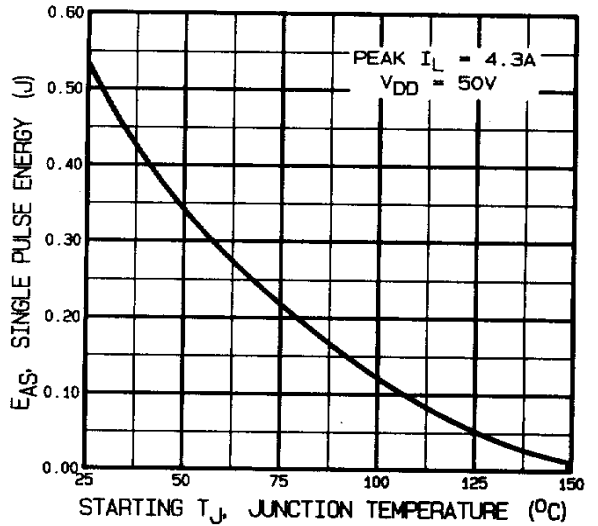

Fig 12c. Maximum Avalanche Energy Vs. Drain Current

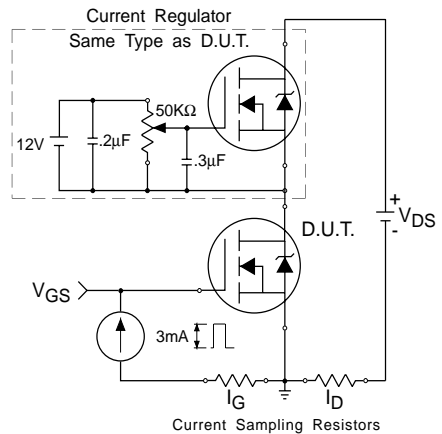
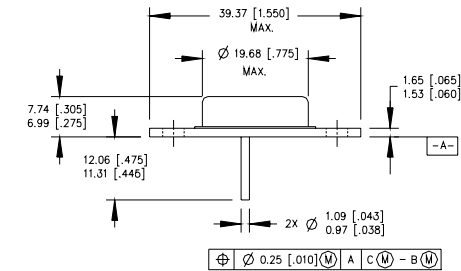

Fig 13b. Gate Charge Test Circuit

**Foot Notes:**

- ① Repetitive Rating; Pulse width limited by maximum junction temperature.
- ②  $V_{DD} = 50V$ , starting  $T_J = 25^{\circ}C$ ,  
Peak  $I_L = 4.3A$ ,
- ③  $I_{SD} \leq 4.3A$ ,  $di/dt \leq 110A/\mu s$ ,  
 $V_{DD} \leq 900V$ ,  $T_J \leq 150^{\circ}C$   
Suggested  $R_G = 9.1 \Omega$
- ④ Pulse width  $\leq 300 \mu s$ ; Duty Cycle  $\leq 2\%$

**Case Outline and Dimensions —TO-204AA (Modified TO-3)**



PIN ASSIGNMENTS

HEXFET	SCHOTTKY	IGBT
1 - SOURCE	1 - ANODE 1	1 - GATE
2 - GATE	2 - ANODE 2	2 - EMITTER
3 - DRAIN (CASE)	3 - COMMON CATHODE (CASE)	3 - COLLECTOR (CASE)

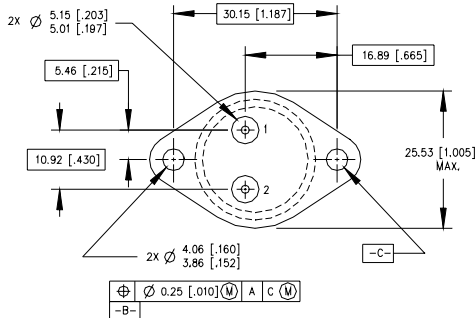

NOTES:

1. DIMENSIONING & TOLERANCING PER ANSI Y14.5M-1982.
2. CONTROLLING DIMENSION : INCH.
3. DIMENSIONS ARE SHOWN IN MILLIMETERS [INCHES].
4. OUTLINE CONFORMS TO JEDEC OUTLINE TO-204-AA.