



Electro-Optic Packaged Components

1.3 μm LED

Product Facts

- High coupled power, typically 75 μW into 62.5 μm fiber
- High reliability MTTW 2.3×10^8 hours
- Wavelength centered at 1320 nm
- Hermetically sealed TO-18 style package installed in industry standard ADMs
- Functional over – 40°C to 85°C operating temperature range

Tyco Electronics' InGaAsP SLED products offer high coupled powers for digital fiber optic transmission applications.

Compatible with industry standards, the Tyco Electronics LED ADMs consist of hermetically sealed TO-18 style SLEDs which have been actively aligned for maximum coupled power. The devices are permanently fixed in place to assure stable performance over all operating conditions.

The ST connectors are suitable for both panel/bulk-head and PC board mounting.

Each unit is burned-in. Coupled power, capacitance, leakage current and spectral characteristics are measured on each unit. No data is supplied with the unit. A lot code is used for traceability. Box label marked with date code on TO's and pigtail ADM parts are physically marked.

For additional information on product qualification, reference Product Specification 108-55008.

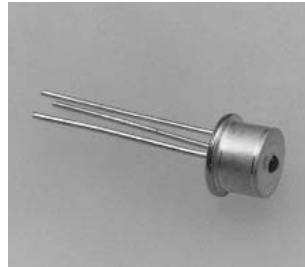

TO

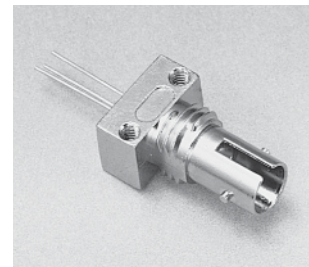

ST Style

Specifications: 100mA Forward Current, 25°C

Parameter	Part No. Suffix	Test Conditions	Units	Min.	Typ.	Max.
Coupled power 50 μm fiber	-1	—	μW dBm	10 -20	20 -17	—
62.5 μm fiber	-1	—	μW dBm	30 -15	45 -13	—
50 μm fiber	-2	—	μW dBm	20 -17	30 -15	—
62.5 μm fiber	-2	—	μW dBm	50 -13	75 -11	—
Wavelength	—	—	nm	1290	—	1350
Spectral FWHM	—	—	nm	—	—	170
Forward voltage	—	—	V	—	1.4	1.7
Capacitance	—	f=1MHz, 0V	pF	—	15	50
Leakage current	—	-2V	μA	—	—	2
Rise/fall time	—	100mA 50% duty cycle 12.5 MHz	ns	—	2.5	4
Bandwidth	—	—	MHz	—	115	—
$\Delta\lambda/\Delta T$	—	-40 to +85°C	nm/°C	—	.38	—
$\Delta P_{out}/\Delta T$	—	—	dB/°C	—	-.03	—
Reliability MTTW	—	-1.5dB EOL	hrs	—	2.3×10^8	—

Note: dBm is rounded to nearest integer value.

Part Numbers

	Connector Interface	
	TO	ST Style
Standard	259006-1	259012-1
Premium	259006-2	259012-2

Note: Coupled power in specifications.



Electro-Optic Packaged Components (Continued)

1.3 μm LED (Continued)

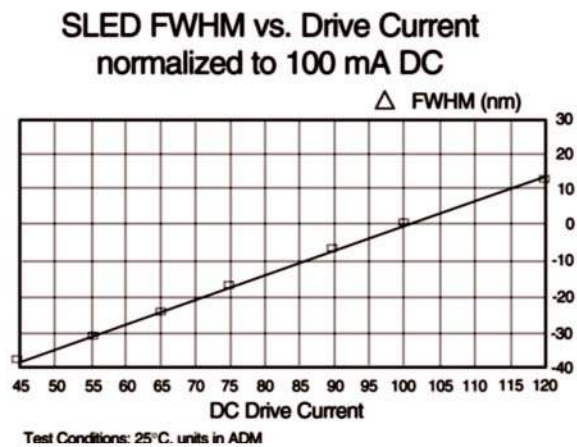
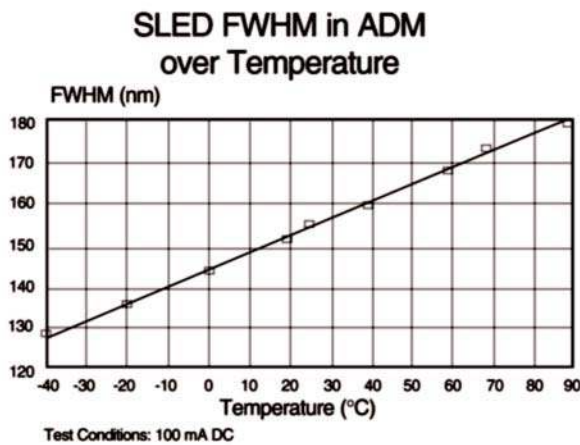
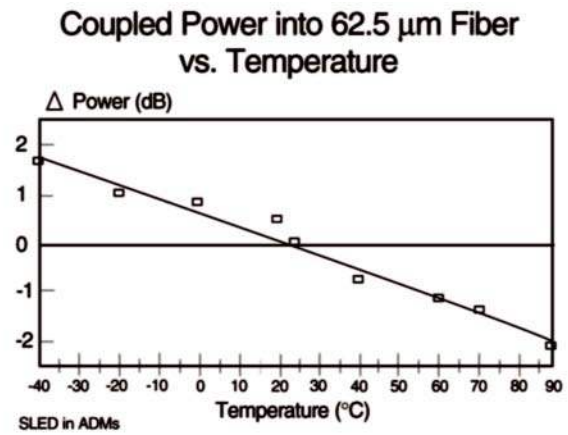
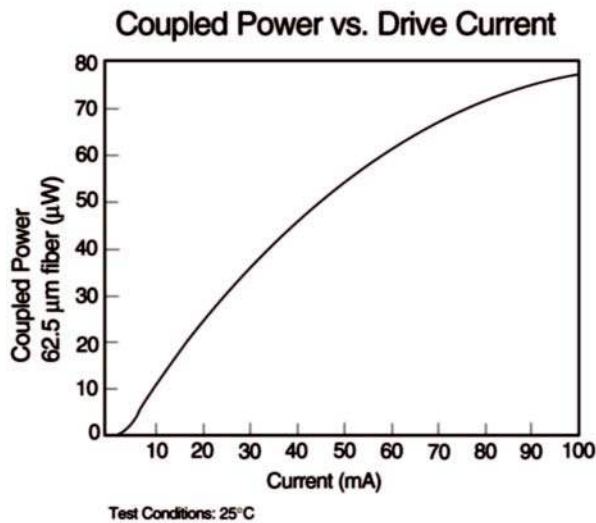

Absolute Maximum Rating

	Units	Min.	Max.
Operating temperature	C	-40	85
Storage temperature	C	-40	125
Reverse voltage	V	—	2
Forward current	mA	—	150

Mechanical Dimension Reference

Figure #	1	2	3
Page No.	202	202	202



Electro-Optic Packaged Components (Continued)

“NEW” 1310nm Fabry-Perot Lasers (TO-56)



TO-56 Laser Low Speed Device

Product Facts

- 1310nm typical emission wavelength
- Low threshold, low operating current
- High-power, wide temperature range operation
- High reliability, long operational life
- Available in two pin-out configurations

Part Numbers

1382568-2 (Case Anode)

1382675-2 (Common Anode)



Tyco Electronics' TO-56 Laser is an InGaAsP/InP-based Strained Multi-Quantum Well (SMQW) device that provides stable, single transverse mode oscillation with emission wavelength of 1310nm.

The Laser packages are uncooled, hermetically sealed for high reliability and incorporate a photodiode for monitoring optical output.

Absolute Maximum Ratings

Symbol	Parameter	Conditions	Ratings	Unit
P _o	Light output power	-	8	mW
V _{RL}	Reverse Voltage (Laser diode)	-	2	V
V _{RD}	Reverse Voltage (Photodiode)	-	20	V
I _{FD}	Forward current (Photodiode)	-	2	mA
T _C	Case Temperature	-	-40 to +85	°C
T _{stg}	Storage Temperature	-	-40 to +85	°C

Electrical/Optical Characteristics

	Symbol	Parameter	Limits			Unit
			Min	Typ.	Max.	
Optical Spectrum	λ _c	Center Wavelength (25 °C)	1280	-	1320	nm
	λ _{ct}	Center Wavelength (-40°C to +85°C)	1260	-	1350	nm
	Δλ	Spectral Width @ P _o = 4mW(-40°C to +85°C)	-	1	2.0	nm
	λ _{cT}	Wavelength temperature coefficient	-	0.4	0.5	nm/°C
Light-Current Curve	I _{th}	Threshold current @ 25°C	-	6	10	mA
	I _{thOT}	Threshold current over temperature (-40°C to +85°C)	1	-	32	mA
Modulation	V _F	Forward Voltage	-	1.2	2.0	V
	η	Slope Efficiency @ 25°C	0.2	0.26	0.4	mW/mA
	I _{DR}	Drive current above I _{th} for 5 mW (-40°C to +85°C)	7	-	20	mA
	P _{th}	Optical Power @ I _{th} -3 mA	-	-	20	μW
	t _r , t _f	Rise & Fall Times	-	-	1.5	ns
Far Field	θ _∥	Beam Divergence (Parallel)	-	18	40	Deg
	θ _⊥	Beam Divergence (Perpendicular)	-	26	40	Deg
Monitor Diode	I _m	Current @ 5 mW (-40°C to +85°C)	0.3	-	0.7	mA
	I _d	Dark current (25°C, V _{RD} = 5V)	-	0.01	0.1	μA
	C _D	Capacitance (V _{RD} = 5V, f = 1MHz)	-	1.2	20	PF



Electro-Optic Packaged Components (Continued)

“NEW” 1310nm Fabry-Perot Lasers (TO-56) (Continued)



TO-56 Laser High Speed Device

Product Facts

- 1310nm typical emission wavelength
- Low threshold, low operating current
- High-power, wide temperature range operation
- High reliability, long operational life
- Available in two pin-out configurations

Part Numbers

1382585-2 (Case Anode)

1382676-2 (Common Anode)



Tyco Electronics' TO-56 Laser is an InGaAsP/InP-based Strained Multi-Quantum Well (SMQW) device that provides stable, single transverse mode oscillation with emission wavelength of 1310nm.

The Laser packages are uncooled, hermetically sealed for high reliability and incorporate a photodiode for monitoring optical output.

Absolute Maximum Ratings

Symbol	Parameter	Conditions	Ratings	Unit
P _o	Light output power	-	8	mW
V _{RL}	Reverse Voltage (Laser diode)	-	2	V
V _{RD}	Reverse Voltage (Photodiode)	-	20	V
I _{FD}	Forward current (Photodiode)	-	2	mA
T _C	Case Temperature	-	-40 to +85	°C
T _{stg}	Storage Temperature	-	-40 to +85	°C

Electrical/Optical Characteristics

	Symbol	Parameter	Limits			Unit
			Min	Typ.	Max.	
Optical Spectrum	λ _c	Center Wavelength (25 °C)	1280	-	1320	nm
	λ _{ct}	Center Wavelength (-40°C to +85°C)	1260	-	1350	nm
	Δλ	Spectral Width @ P _o = 4mW(-40°C to +85°C)	-	1	3.0	nm
	λ _{cT}	Wavelength temperature coefficient	-	0.4	0.5	nm/°C
Light-Current Curve	I _{th}	Threshold current @ 25°C	-	6	10	mA
	I _{thOT}	Threshold current over temperature (-40°C to +85°C)	1	-	40	mA
Modulation	V _F	Forward Voltage	-	1.2	2.0	V
	η	Slope Efficiency @ 25°C I _{th} +10 mA	0.2	0.26	0.4	mW/mA
	I _{DR}	Drive current above I _{th} for 5 mW (-40°C to +85°C)	9	-	25	mA
	P _{th}	Optical Power @ I _{th} +3 mA	-	-	20	μW
Far Field	t _r , t _f	Rise & Fall Times	-	-	0.2	ns
	θ _∥	Beam Divergence (Parallel)	-	18	40	Deg
Monitor Diode	θ _⊥	Beam Divergence (Perpendicular)	-	26	40	Deg
	I _m	Current @ 5 mW (-40°C to +85°C)	0.3	-	0.7	mA
	I _d	Dark current (25°C, V _{RD} = 5V)	-	0.01	0.1	μA
	C _D	Capacitance (V _{RD} = 5V, f = 1MHz)	-	1.2	20	PF



Electro-Optic Packaged Components (Continued)

“NEW” Singlemode Receptacle Transmitters



SC Receptacle Transmitter Optical Subassembly Low Speed

Product Facts

- 156 Mb/s data rates
- 1310nm typical emission wavelength
- Low threshold, low operating current
- Singlemode fiber stub with split sleeve
- Wide temperature range operation
- High reliability, long operational life
- Telecordia GR-468 qualified

Part Numbers

- 1382459-1 (Case Anode - 0 to -5 dBm)
- 1382459-2 (Common Anode - 0 to -5 dBm)
- 1382461-1 (Case Anode - -8 to -14 dBm)
- 1382461-2 (Common Anode - -8 to -14 dBm)



Tyco Electronics' SC Receptacle Transmitter Optical Subassembly (OSA), with InGaAsP/InP-based Strained Multi-Quantum Well (SMQW) device, provides stable, single transverse mode oscillation with emission wavelength of 1310nm.

The OSA's are uncooled, hermetically sealed for high reliability and incorporate a photodiode for monitoring optical output.

Absolute Maximum Ratings - 1382459-1, -2

Symbol	Parameter	Conditions	Limits		Unit
			Min	Max	
I_f	Laser Forward Current	DC	-	150	mA
I_r	Laser Reverse Current	DC	-	100	uA
V_{RL}	Reverse Voltage (Laser diode)	DC	-	2	V
V_{RD}	Reverse Voltage (Photodiode)	DC	-	20	V
I_{FD}	Forward current (Photodiode)	-	-	2	mA
T_C	Operating Case Temperature	-	0	+70	°C
T_{std}	Storage Temperature	-	-40	+85	°C

Electrical/Optical Characteristics - 1382459-1, -2

	Symbol	Parameter	Test Condition	Limits			Unit
				Min	Typ.	Max.	
Optical Spectrum	P_o	Optical Output Power (CW)	Reference Grade Cable $T_c=0^\circ\text{C}$ to $+70^\circ\text{C}$	-5	-	0	dB
				0.312		1.0	μW
	λ_c	Central Wavelength	$T_c=25^\circ\text{C}$	1290	-	1315	nm
			$T_c=0^\circ\text{C}$ to $+70^\circ\text{C}$	1280		1335	
	$\Delta\lambda$	Spectral Width (0°C to $+70^\circ\text{C}$)	One Sigma, RMS	-	1	2.5	nm
	λ_{cT}	Wavelength temperature coefficient		-	0.4	0.5	nm/°C
Light-Current Curve	I_{th}	Threshold current	$T_c=25^\circ\text{C}$	3	6	10	mA
			$T_c=0^\circ\text{C}$ to $+70^\circ\text{C}$	1.5		25	mA
	V_F	Forward Voltage		-	1.2	2.0	V
	η	Slope Efficiency	$T_c=25^\circ\text{C}$	32	48	60	$\mu\text{W}/\text{mA}$
	I_d	Drive Current above I_{th} @ P_{oMAX} (CW)	$T_c=25^\circ\text{C}$	17	-	32	mA
			$T_c=0^\circ\text{C}$ to $+70^\circ\text{C}$	17	-	40	mA
	P_{th}	Coupled Power in "off" state	$I = I_{th} - 2\text{mA}$	-	-	12	μW
Modulation	t_r, t_f	Rise & Fall Times	20% - 80%	-	-	1.5	ns
Monitor	I_m	Monitor Output current @ P_{oMAX}	$T_c=0^\circ\text{C}$ to $+70^\circ\text{C}$	0.5	-	1.3	mA
Diode		Dark current, Photodiode	$V_{RD} = 5\text{V}$ $T_c=0^\circ\text{C}$ to $+70^\circ\text{C}$	-	0.01	0.1	mA
	C_D	Capacitance, Photodiode	$V_{RD} = 5\text{V}$, 1MHz $T_c=0^\circ\text{C}$ to $+70^\circ\text{C}$	-	1.2	20	pF
	ΔR	Tracking Error @ P_{oMAX}	$T_c=0^\circ\text{C}$ to $+70^\circ\text{C}$			± 1.0	dB



Electro-Optic Packaged Components (Continued)

“NEW” Singlemode Receptacle Transmitters (Continued)

SC Receptacle Transmitter Optical Subassembly Low Speed (Continued)

Part Numbers

1382459-1 (Case Anode - 0 to -5 dBm)

1382459-2 (Common Anode - 0 to -5 dBm)

1382461-1 (Case Anode - -8 to -14 dBm)

1382461-2 (Common Anode - -8 to -14 dBm)

Absolute Maximum Ratings - 1382461-1, -2

Symbol	Parameter	Conditions	Limits		Unit
			Min	Max	
I_f	Laser Forward Current	DC	-	150	mA
I_r	Laser Reverse Current	DC	-	100	uA
V_{RL}	Reverse Voltage (Laser diode)	DC	-	2	V
V_{RD}	Reverse Voltage (Photodiode)	DC	-	20	V
I_{FD}	Forward current (Photodiode)	-	-	2	mA
T_C	Operating Case Temperature	-	-40	+85	°C
T_{stg}	Storage Temperature	-	-40	+85	°C

Electrical/Optical Characteristics - 1382461-1, -2

	Symbol	Parameter	Test Condition	Limits			Unit
				Min	Typ.	Max.	
Optical Spectrum	P_o	Optical Output Power (CW)	Reference Grade Cable $T_c = -40^\circ\text{C}$ to $+85^\circ\text{C}$	-14 39	-	-8 158	dB μW
	λ_c	Central Wavelength	$T_c = 25^\circ\text{C}$ $T_c = -40^\circ\text{C}$ to $+85^\circ\text{C}$	1290 1261	-	1333 1360	nm
	$\Delta\lambda$	Spectral Width (-40°C to +85°C)	One Sigma, RMS	-	1	2.5	nm
	λ_{cT}	Wavelength temperature coefficient		-	0.4	0.5	nm/°C
Light-Current Curve	I_{th}	Threshold current	$T_c = 25^\circ\text{C}$ $T_c = -40^\circ\text{C}$ to $+85^\circ\text{C}$	3 1.5	6	10 32	mA mA
	V_F	Forward Voltage		-	1.2	2.0	V
	η	Slope Efficiency	$T_c = 25^\circ\text{C}$	18	-	30	uW/mA
	I_d	Drive Current above I_{th} @ P_{oMAX} (CW)	$T_c = 25^\circ\text{C}$ $T_c = -40^\circ\text{C}$ to $+85^\circ\text{C}$	5 4	-	9 13	mA mA
	P_{th}	Coupled Power in "off" state	$I = I_{th} - 2\text{mA}$	-	-	12	μW
Modulation	t_r, t_f	Rise & Fall Times	20% - 80%	-	-	1.5	ns
Monitor	I_m	Monitor Output current @ P_{oMAX}	$T_c = -40^\circ\text{C}$ to $+85^\circ\text{C}$	0.2	-	0.45	mA
Diode		Dark current, Photodiode	$V_{RD} = 5\text{V}$ $T_c = -40^\circ\text{C}$ to $+85^\circ\text{C}$	-	0.01	0.1	mA
	C_D	Capacitance, Photodiode	$V_{RD} = 5\text{V}, 1\text{MHz}$ $T_c = -40^\circ\text{C}$ to $+85^\circ\text{C}$	-	1.2	20	pF
	ΔR	Tracking Error @ P_{oMAX}	$T_c = -40^\circ\text{C}$ to $+85^\circ\text{C}$			± 1.5	dB



Electro-Optic Packaged Components (Continued)

“NEW” Singlemode Receptacle Transmitters (Continued)



SC Receptacle Transmitter Optical Subassembly High Speed

Product Facts

- Data rates up to 3.125 Gb/s
- 1310nm typical emission wavelength
- Low threshold, low operating current
- Singlemode fiber stub with split sleeve
- Wide temperature range operation
- High reliability, long operational life
- Telecordia GR-468 qualified

Part Numbers

- 1382462-1 (Case Anode)
1382462-2 (Common Anode)



Tyco Electronics' SC Receptacle Transmitter Optical Subassembly (OSA), with InGaAsP/InP-based Strained Multi-Quantum Well (SMQW) device, provides stable, single transverse mode oscillation with emission wavelength of 1310nm.

The OSA's are uncooled, hermetically sealed for high reliability and incorporate a photodiode for monitoring optical output.

Absolute Maximum Ratings

Symbol	Parameter	Conditions	Limits		Unit
			Min	Max	
I_f	Laser Forward Current	DC	-	150	mA
I_r	Laser Reverse Current	DC	-	100	uA
V_{RL}	Reverse Voltage (Laser diode)	DC	-	2	V
V_{RD}	Reverse Voltage (Photodiode)	DC	-	20	V
I_{FD}	Forward current (Photodiode)	-	-	2	mA
T_C	Operating Case Temperature	-	-40	+85	°C
T_{std}	Storage Temperature	-	-40	+85	°C

Electrical/Optical Characteristics

	Symbol	Parameter	Test Condition	Limits			Unit
				Min	Typ.	Max.	
Optical Spectrum	P_o	Optical Output Power (CW)	Reference Grade	-14	-	-8	dB
			Cable $T_c = -40^\circ\text{C}$ to $+85^\circ\text{C}$	39	-	158	μW
	λ_c	Central Wavelength	$T_c = 25^\circ\text{C}$	1303	-	1329	nm
			$T_c = -40^\circ\text{C}$ to $+85^\circ\text{C}$	1274	-	1356	
	$\Delta\lambda$	Spectral Width (-40°C to $+85^\circ\text{C}$)	One Sigma, RMS	-	1	2.5	nm
	λ_{cT}	Wavelength temperature coefficient		-	0.4	0.5	nm/°C
Light-Current Curve	I_{th}	Threshold current	$T_c = 25^\circ\text{C}$	3	6	10	mA
			$T_c = -40^\circ\text{C}$ to $+85^\circ\text{C}$	1.5	-	32	mA
	V_F	Forward Voltage		-	1.2	2.0	V
	η	Slope Efficiency	$T_c = 25^\circ\text{C}$	18	-	30	$\mu\text{W}/\text{mA}$
	I_d	Drive Current above I_{th} @ P_{oMAX} (CW)	$T_c = 25^\circ\text{C}$	5	-	9	mA
		$T_c = -40^\circ\text{C}$ to $+85^\circ\text{C}$	4	-	13	mA	
	P_{th}	Coupled Power in "off" state	$I = I_{th} - 2\text{mA}$	-	-	12	μW
Modulation	t_r, t_f	Rise & Fall Times	20% - 80%	-	-	1.5	ns
Monitor	I_m	Monitor Output current @ P_{oMAX}	$T_c = -40^\circ\text{C}$ to $+85^\circ\text{C}$	0.1	-	0.6	mA
Diode		Dark current, Photodiode	$V_{RD} = 5\text{V}$ $T_c = -40^\circ\text{C}$ to $+85^\circ\text{C}$	-	0.01	0.1	mA
	C_D	Capacitance, Photodiode	$V_{RD} = 5\text{V}, 1\text{MHz}$ $T_c = -40^\circ\text{C}$ to $+85^\circ\text{C}$	-	1.2	20	pF
	ΔR	Tracking Error @ P_{oMAX}	$T_c = -40^\circ\text{C}$ to $+85^\circ\text{C}$	-	-	± 1.5	dB



Electro-Optic Packaged Components (Continued)

“NEW” Singlemode Receptacle Transmitters (Continued)



LC Receptacle Transmitter Optical Subassembly High Speed

Product Facts

- Data rates up to 3.125 Gb/s
- 1310nm typical emission wavelength
- Low threshold, low operating current
- Singlemode fiber stub with split sleeve
- Wide temperature range operation
- High reliability, long operational life
- Telecordia GR-468 qualified

Part Numbers

1382482-1 (Case Anode)

1382482-2 (Common Anode)



Tyco Electronics' SC Receptacle Transmitter Optical Subassembly (OSA), with InGaAsP/InP-based Strained Multi-Quantum Well (SMQW) device, provides stable, single transverse mode oscillation with emission wavelength of 1310nm.

The OSA's are uncooled, hermetically sealed for high reliability and incorporate a photodiode for monitoring optical output.

Absolute Maximum Ratings

Symbol	Parameter	Conditions	Limits		Unit
			Min	Max	
I_f	Laser Forward Current	DC	-	150	mA
I_r	Laser Reverse Current	DC	-	100	uA
V_{RL}	Reverse Voltage (Laser diode)	DC	-	2	V
V_{RD}	Reverse Voltage (Photodiode)	DC	-	20	V
I_{FD}	Forward current (Photodiode)	-	-	2	mA
T_C	Operating Case Temperature	-	-40	+85	°C
T_{std}	Storage Temperature	-	-40	+85	°C

Electrical/Optical Characteristics

	Symbol	Parameter	Test Condition	Limits			Unit
				Min	Typ.	Max.	
Optical Spectrum	P_o	Optical Output Power (CW)	Reference Grade Cable $T_c = -40^\circ\text{C}$ to $+85^\circ\text{C}$	-10 100	-	-3 500	dB μW
	λ_c	Central Wavelength	$T_c = 25^\circ\text{C}$ $T_c = -40^\circ\text{C}$ to $+85^\circ\text{C}$	1295 1266	-	1333 1360	nm
	$\Delta\lambda$	Spectral Width (-40°C to $+85^\circ\text{C}$)	One Sigma, RMS	-	1	2.5	nm
	λ_{cT}	Wavelength temperature coefficient		-	0.4	0.5	nm/°C
Light-Current Curve	I_{th}	Threshold current	$T_c = 25^\circ\text{C}$ $T_c = -40^\circ\text{C}$ to $+85^\circ\text{C}$	3 1.5	6	10 32	mA mA
	V_F	Forward Voltage		-	1.2	2.0	V
	η	Slope Efficiency	$T_c = 25^\circ\text{C}$	30	-	50	$\mu\text{W}/\text{mA}$
	I_d	Drive Current above I_{th} @ P_{oMAX} (CW)	$T_c = 25^\circ\text{C}$ $T_c = -40^\circ\text{C}$ to $+85^\circ\text{C}$	10 9	-	16 24	mA mA
	P_{th}	Coupled Power in "off" state	$I = I_{th} - 2\text{mA}$	-	-	12	μW
Modulation	t_r, t_f	Rise & Fall Times	20% - 80%	-	0.2	ns	
Monitor	I_m	Monitor Output current @ P_{oMAX}	$T_c = -40^\circ\text{C}$ to $+85^\circ\text{C}$	0.3	0.5	0.7	mA
Diode		Dark current, Photodiode	$V_{RD} = 5\text{V}$ $T_c = -40^\circ\text{C}$ to $+85^\circ\text{C}$	-	0.01	0.1	mA
	C_D	Capacitance, Photodiode	$V_{RD} = 5\text{V}, 1\text{MHz}$ $T_c = -40^\circ\text{C}$ to $+85^\circ\text{C}$	-	1.2	20	pF
	ΔR	Tracking Error @ P_{oMAX}	$T_c = -40^\circ\text{C}$ to $+85^\circ\text{C}$			± 1.5	dB



Electro-Optic Packaged Components (Continued)

“NEW” Singlemode Receptacle Receivers



1.25 Gb/s to 2.5 Gb/s Receiver

Product Facts

- Low Cost
- InGaAs/InP PIN Photodiode with transimpedance amplifier
- High sensitivity with automatic gain control
- Differential ended operation
- LC interface

Part Numbers

1382649-1 (High Reflectance)
1382650-1 (Low Reflectance)



Tyco Electronics' Receivers 1382649-1 and 1382650-1 are low cost LC connectorized metal ADM assemblies, suitable for short and intermediate reach applications. These receivers incorporate a highly reliable MOCVD InP PIN photodiode and TIA. This design operates at 3.3V

and is suitable for transceiver applications.

Normal static precautions should be taken with handling these components to prevent ESD damage or degradation.

Absolute Maximum Ratings

Parameter	Symbol	Specification	Units
Operating Temperature	T _{OP}	-40 to +85	°C
Storage Temperature	T _{STG}	-40 to +85	°C

Electrical/Optical Characteristics

Parameter	Symbol	Spec Min	Typical	Spec Max	Units	Conditions
Differential Gain @ -10dBm	G	5	6.7	8	mV/uW	250kHz, 25°C
Bandwidth, -40°C to +85°C	f _C	1.8			GHz	
Bandwidth, +25°C	f _C		2.1		GHz	
Sensitivity @ 1.25GHz -40°C to +85°C	P _{LOW}	-19			dBm	2 ^{23.1} PBRS, BER 10 ⁻¹⁰
Sensitivity @ 1.25GHz +25°C	P _{LOW}		-26		dBm	2 ^{23.1} PBRS, BER 10 ⁻¹⁰
Sensitivity @ 2.5GHz -40°C to +85°C	P _{LOW}	-18			dBm	2 ^{23.1} PBRS, BER 10 ⁻¹⁰
Sensitivity @ 2.5GHz +25°C	P _{LOW}		-21		dBm	2 ^{23.1} PBRS, BER 10 ⁻¹⁰
Max Optical Input Power	P _{HIGH}			0	dBm	
Reflectance, 1382649-1 (HR)	R _{ref}			-14	dB	
Reflectance, 1382650-1 (LR)	R _{ref}			-30	dB	
Power Supply Current	I _{DD}			50	mA	-40°C to +85°C

Electro-Optic Packaged Components (Continued)**“NEW” Singlemode Receptacle Receivers (Continued)****155 Mb/s Receiver****Product Facts**

- Low Cost
- InGaAs/InP PIN Photodiode with transimpedance amplifier
- High sensitivity with automatic gain control
- Differential ended operation
- SC interface

Part Number
1382594-1



Tyco Electronics' Receiver 1382594-1 is a low cost LC connectorized metal ADM assembly, suitable for short and intermediate reach applications. This receiver incorporates a highly reliable MOCVD InP PIN photodiode

and TIA. The design operates at 3.3V and 5.0V and is suitable for transceiver applications.

Normal static precautions should be taken when handling this component to prevent ESD damage or degradation.

Absolute Maximum Ratings

Parameter	Symbol	Specification	Units
Operating Temperature 155 Mb/s	T _{OP}	0 to +70	°C
Operating Temperature 622 Mb/s	T _{OP}	-40 to +85	°C
Storage Temperature	T _{STG}	-40 to +85	°C

Electrical/Optical Characteristics

Parameter	Symbol	Spec Min	Typical	Spec Max	Units	Conditions
Differential Gain @ -18dBm	G	10	12.4	15	mV/uW	250kHz, 25°C
Bandwidth, -0°C to +70°C	f _C	120			MHz	
Bandwidth, +25°C	f _C		525		MHz	
Sensitivity -0°C to +70°C	P _{LOW}	-34			dBm	2 ²³ -1 PBRS, BER 10 ⁻¹⁰
Sensitivity +25°C	P _{LOW}		-36		dBm	2 ²³ -1 PBRS, BER 10 ⁻¹⁰
Max Optical Input Power	P _{HIGH}			-10	dBm	
Optical Impedance	Z _o	36	44	57	Ω	
Reflectance	R _{ref}			-14	dB	
Power Supply Current	I _{DD}			50	mA	-0°C to +70°C



Electro-Optic Packaged Components (Continued)

Multimode InGaAs Photodetector

Product Facts

- High reliability passivated planar structure
- High responsivity
- Low dark current
- Low capacitance
- Hermetically sealed TO-18 style package installed in industry standard ADMs
- -40° to $+85^{\circ}\text{C}$ operating temperature range

Tyco Electronics' multimode design using InGaAs PIN photodetectors offers high responsivity for nearly all digital and analog fiber optic applications. The unique design balances high-speed performance with noise-free linear output. Spectral response has been optimized for the long wavelength region of 1150 nm to 1600 nm. Every component delivered has passed extensive high-temperature screening to ensure long-term reliability.

Compatible with industry standards, Tyco Electronics' Active Device Mount components incorporate hermetically sealed TO-18 style PIN packages which have been actively aligned for optimal performance. ST modules are suitable for both panel/bulkhead and PC board mounting. Each unit is burned-in.

Responsivity, dark current and capacitance are measured on each unit. No data is supplied with the unit. A lot code is used for traceability.

For additional information on product qualification, reference Product Specification 108-55009.

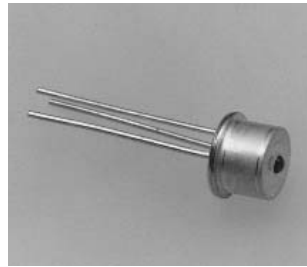

TO



ST Style

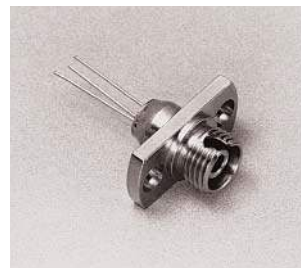

FC

Specifications: 25°C, -5 Volts

Parameter	P/N	Test Conditions	Units	Min.	Typ.	Max.
Responsivity						
50 μm	-1	LED source	A/W	.60	.71	—
62.5 μm	-1	of 10 μW	A/W	.50	.61	—
50 μm	-2	LED source	A/W	.75	.83	—
62.5 μm	-2	of 10 μW	A/W	.65	.80	—
Spectral Response	-1, 2	—	nm	1150	—	1600
Capacitance	-1, 2	f=1MHz	pF	—	1.5	1.7
Dark current	-1, 2	—	nA	—	1.5	5
Rise/fall	-1, 2	—	ns	—	—	1
Bandwidth	-1, 2	—	GHz	—	1.5	—
Reliability	-1, 2	$I_b > 5\text{nA}$	hrs	—	2.0×10^8	—

Part Numbers

	Connector Interface		
	TO	FC	ST Style
Standard	259007-1	259015-1	259013-1
Premium	259007-2	259015-2	259013-2



Electro-Optic Packaged Components (Continued)

Multimode InGaAs Photodetector (Continued)

Capacitance

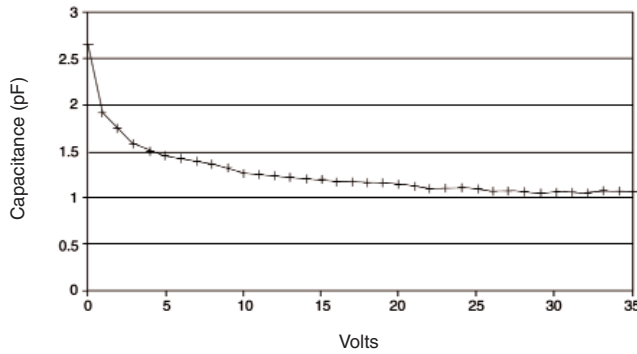

Dark Current

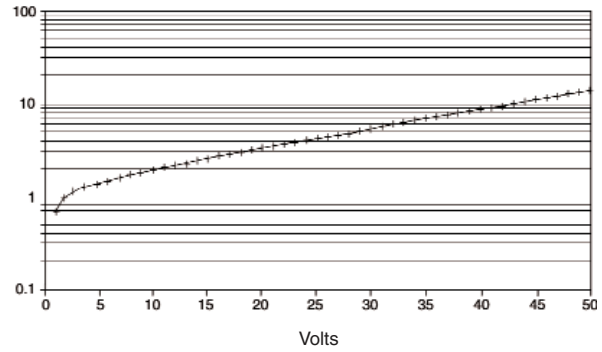

Responsivity vs. Temperature

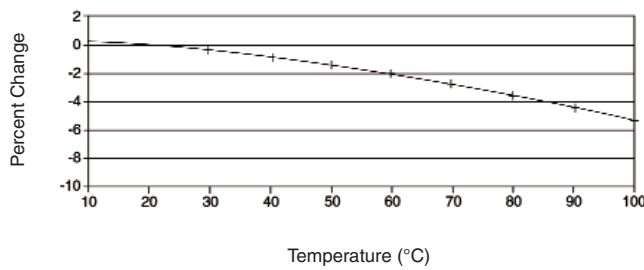

Dark Current vs. Temperature

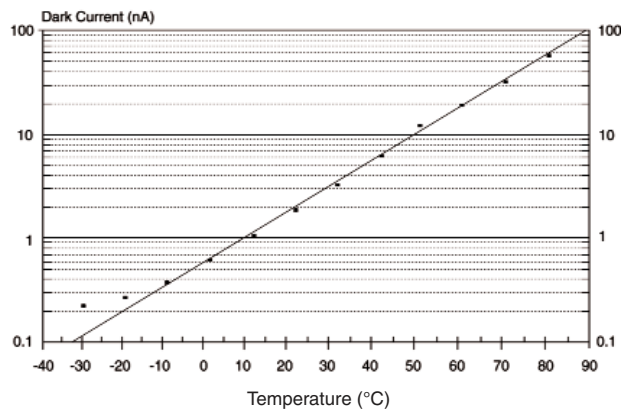

Absolute Maximum Rating

	Units	Min.	Max.
Operating temperature	°C	-40	85
Storage temperature	°C	-40	125
Reverse current	mA	—	1

Mechanical Dimension Reference

Figure #	1	2	3
Page No.	202	202	202

Electro-Optic Packaged Components (Continued)

Mechanical Dimensions

TO Package PIN + LED

Part Numbers
 259006-1, -2
 259007-1, -2

Part No. Suffix	A	B
-1	2.05 0.81	.660 .026
-2	1.52 .060	.510 .020

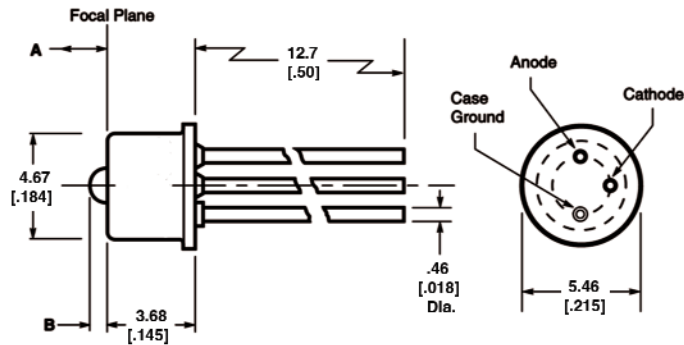

Figure 1

ST Style Board Mount/Panel Mount PIN + LED

Part Numbers
 259012-1, -2
 259013-1, -2

Part No. Suffix	Description
-1	Standard
-2	Premium

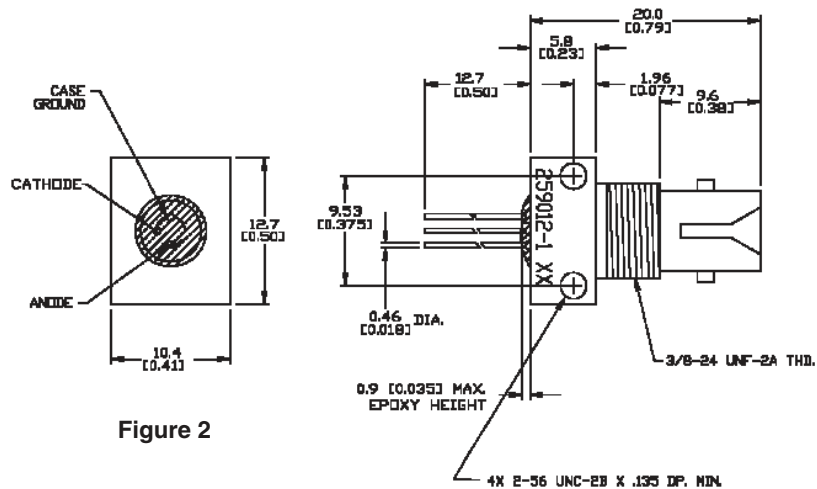

Figure 2

FC Type Panel Mount PIN

Part Numbers
 259015-1, -2

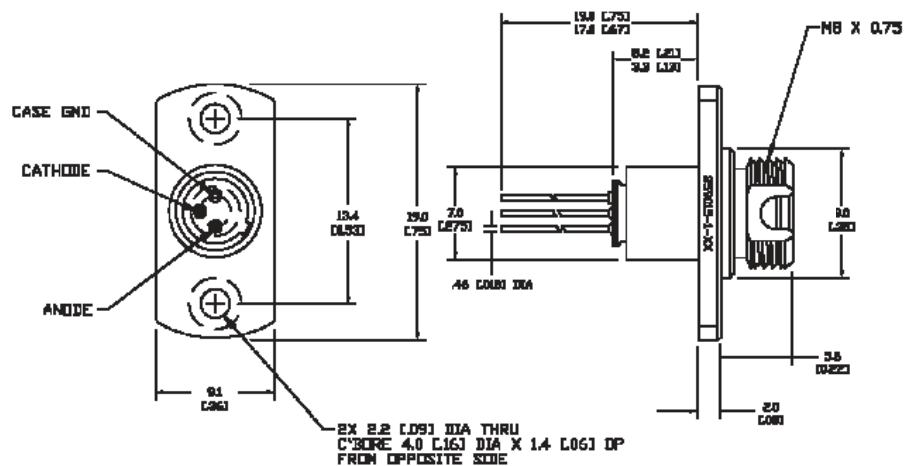

Figure 3