







# SMT POWER INDUCTORS

## Flat Coils - PG0155NL Series



-  All Inductors are RoHS Compliant
-  **Height:** 3.7mm Max
-  **Footprint:** 11.0mm x 10.4mm Max
-  **Current Rating:** up to 24A
-  **Inductance Range:** 0.30μH to 0.91μH
-  High temperature core material, no thermal aging below 150°C

### Electrical Specifications @ 25°C — Operating Temperature -40°C to +130°C<sup>1</sup>

| Part Number  | Inductance @ I <sub>rated</sub> <sup>2</sup> (μH TYP) | I <sub>rated</sub> <sup>3</sup> (A) | DCR (mΩ) |     | Inductance @ 0A <sub>dc</sub> (μH ±20%) | Saturation <sup>4</sup> Current I <sub>SAT</sub> (A) | Heating <sup>5</sup> Current I <sub>dc</sub> (A) | Core Loss <sup>6</sup> Factor (K2) |
|--------------|-------------------------------------------------------|-------------------------------------|----------|-----|-----------------------------------------|------------------------------------------------------|--------------------------------------------------|------------------------------------|
|              |                                                       |                                     | TYP      | MAX |                                         |                                                      |                                                  |                                    |
| PG0155.331NL | 0.30                                                  | 24                                  | 1.7      | 2.2 | 0.33                                    | 38                                                   | 24                                               | 81.36                              |
| PG0155.601NL | 0.53                                                  | 19                                  | 2.8      | 3.2 | 0.60                                    | 27                                                   | 19                                               | 108.47                             |
| PG0155.102NL | 0.91                                                  | 14                                  | 5.3      | 5.8 | 1.0                                     | 21.5                                                 | 14                                               | 142.73                             |

### Mechanical

### Schematic

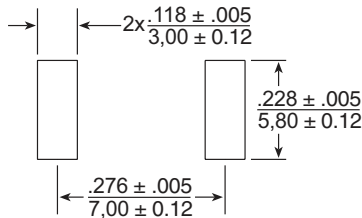
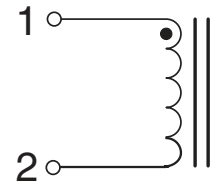
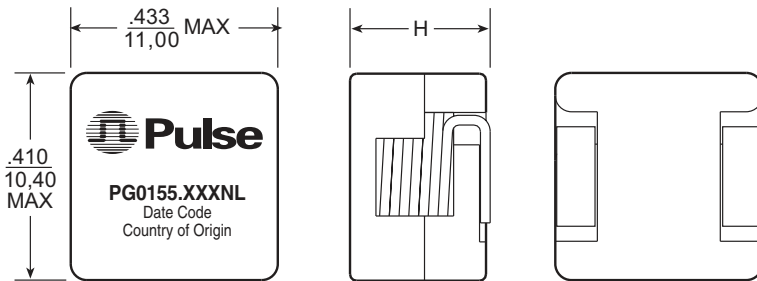

SUGGESTED PAD LAYOUT

| Part No.     | Max. Height "H" (in./mm) |
|--------------|--------------------------|
| PG0155.331NL | .146/3,7                 |
| PG0155.601NL | .146/3,7                 |
| PG0155.102NL | .142/3,6                 |

Weight . . . . .1.6 grams  
Tape & Reel . . . . . .850/reel

Dimensions: Inches  
mm  
Unless otherwise specified,  
all tolerances are ± .010  
0,25

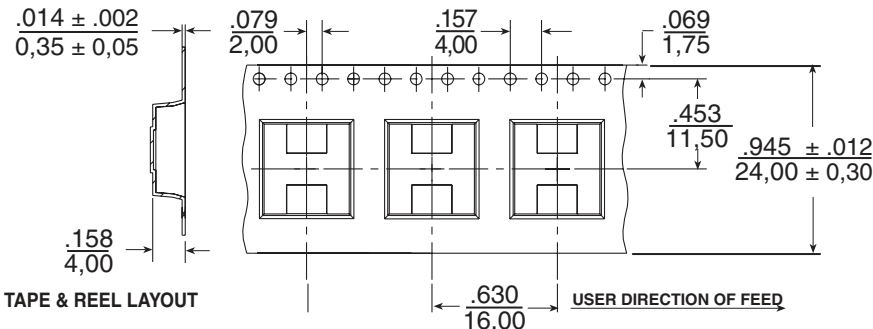

TAPE & REEL LAYOUT

# SMT POWER INDUCTORS

## Flat Coils - PG0155NL Series



### Notes from Tables

1. The temperature of the component (ambient plus temperature rise) must be within the standard operating temperature range.
2. Inductance at  $I_{rated}$  is a typical inductance value for the component taken at rated current.
3. The rated current listed is the lower of the saturation current @ 25°C or the heating current.
4. The saturation current,  $I_{sat}$ , is the current at which the component inductance drops by 20% (typical) at an ambient temperature of 25°C. This current is determined by placing the component in the specified ambient environment and applying a short duration pulse current (to eliminate self-heating effects) to the component.
5. The heating current,  $I_{DC}$ , is the DC current required to raise the component temperature by approximately 40°C. The heating current is determined by mounting the component on a typical PCB and applying current for 30 minutes. The temperature is measured by placing the thermocouple on top of the unit under

test. Take note that the component's performance varies depending on the system condition. It is suggested that the component be tested at the system level, to verify the temperature rise of the component during system operation.

6. Core loss approximation is based on published core data:

$$\text{Core Loss} = K1 * (f)^{1.30} * (K2\Delta I)^{2.41}$$

Where: Core Loss = in Watts

$$K1 = 1.20E-10$$

$f$  = switching frequency in kHz

$K1$  &  $K2$  = core loss factors

$\Delta I$  = delta I across the component in Ampere

$K2\Delta I$  = one half of the peak to peak flux density across the component in Gauss

7. Unless otherwise specified, all testing is made at 100kHz, 0.1V<sub>AC</sub>.
8. Add suffix "T" to the part number for Tape & Reel packaging (ex: PG0155.331NLT).

### Inductance vs Current Characteristics

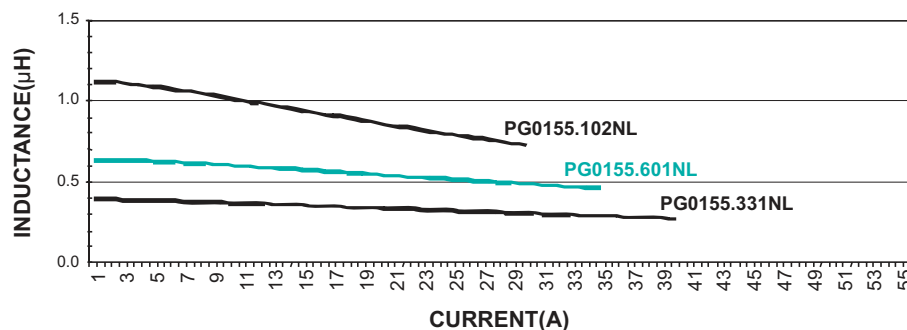

### Typical Core Loss vs Peak Flux Density

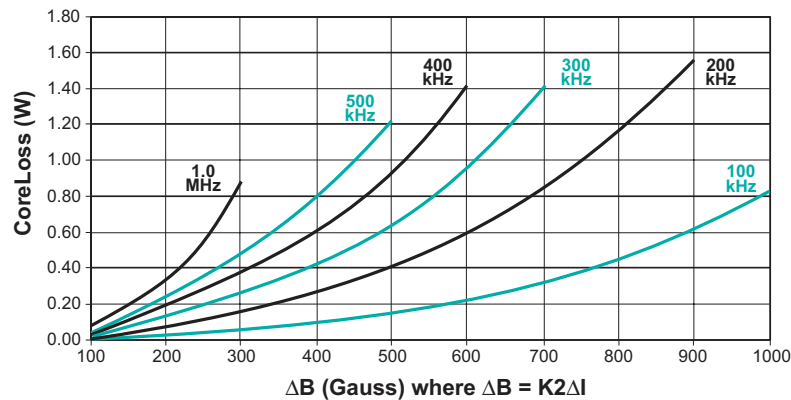

### For More Information:

#### Pulse Worldwide Headquarters

12220 World Trade Dr.  
San Diego, CA 92128  
U.S.A.  
[www.pulseeng.com](http://www.pulseeng.com)

Tel: 858 674 8100  
Fax: 858 674 8262

#### Pulse Europe

Einsteinstrasse 1  
D-71083 Herrenberg  
Germany

Tel: 49 7032 7806 0  
Fax: 49 7032 7806 12

#### Pulse China Headquarters

B402, Shenzhen  
Tech-Innovation International  
Tenth Kejian Rd.  
High-Tech Industrial Park  
Nanshan District, Shenzhen  
China

Tel: 86 755 33966678  
Fax: 86 755 33966700

#### Pulse North China

Room 1503  
XinYin Building  
No. 888 YiShan Rd.  
Shanghai 200233  
China

Tel: 86 21 54643211/2  
Fax: 86 21 54643210

#### Pulse South Asia

150 Kampong Ampat  
#07-01/02  
KA Centre  
Singapore 368324

Tel: 65 6287 8998  
Fax: 65 6280 0080

#### Pulse North Asia

No. 26  
Kao Ching Rd.  
Yang Mei Chen  
Tao Yuan Hsien  
Taiwan, R. O. C.

Tel: 886 3 4641811  
Fax: 886 3 4641911

Performance warranty of products offered on this data sheet is limited to the parameters specified. Data is subject to change without notice. Other brand and product names mentioned herein may be trademarks or registered trademarks of their respective owners. © Copyright, 2007. Pulse Engineering, Inc. All rights reserved.