

Surface Mount Cermet Trimmers (12 Turns)

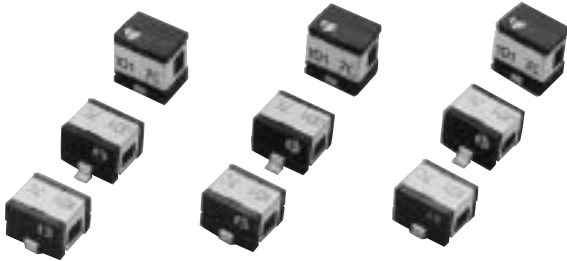

FEATURES

- Lead (Pb)-free soldering, Cadmium-free
- Fine adjustment is possible
- Automatic mounting is possible (Taping)
- Flow/reflow soldering is possible
- Sealed construction (Washable)
- RoHS compatible

DIMENSIONS in millimeters

RECOMMENDED P.C.B. PAD OUTLINE DIMENSIONS

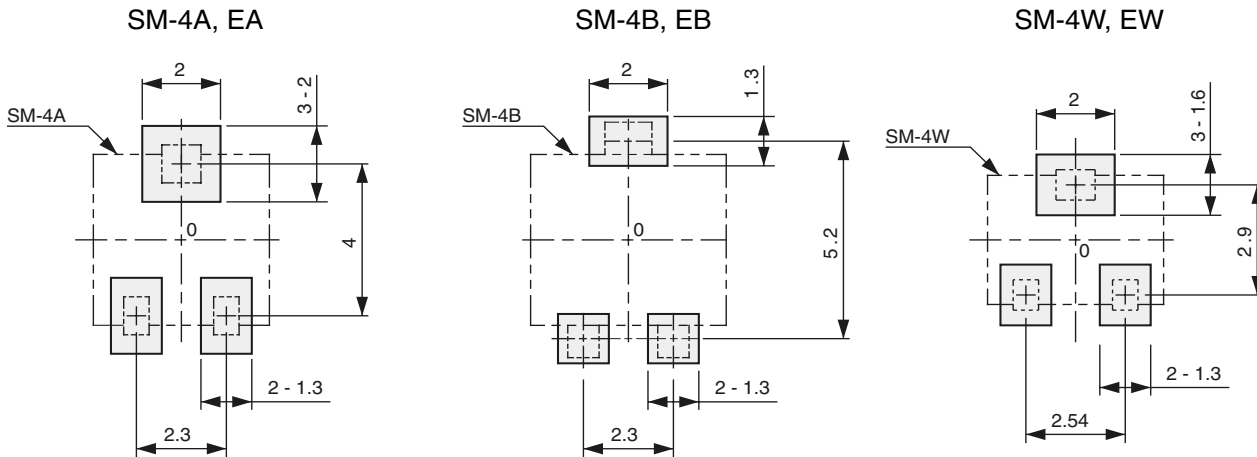

Note) The zero point is the center of mounting.

OUTLINE DIMENSIONS

Unless otherwise specified, tolerance: ± 0.3 (Unit: mm)

SM-4A, SM-4EA
Side adjustment

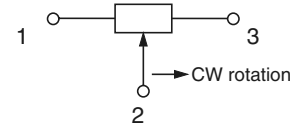
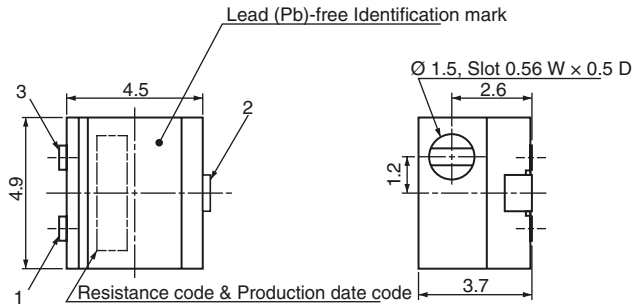

* Note the terminal position.

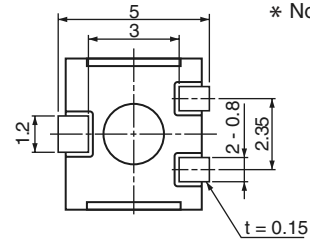

SM-4B, SM-4EB
Side adjustment

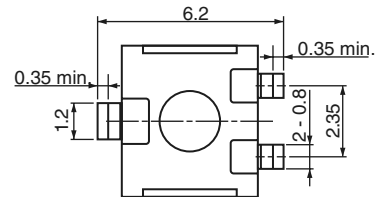
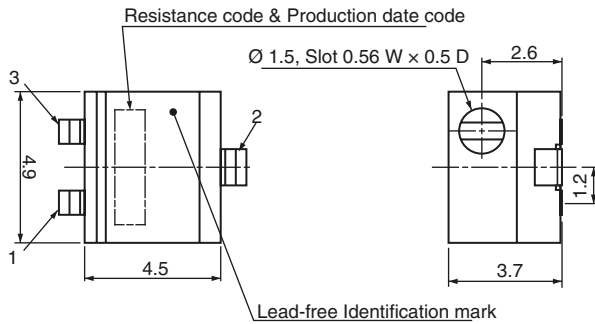

SM-4W, SM-4EW
Top adjustment

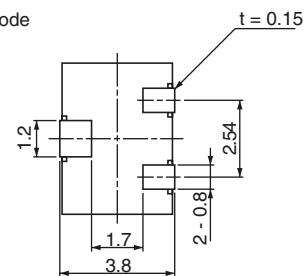
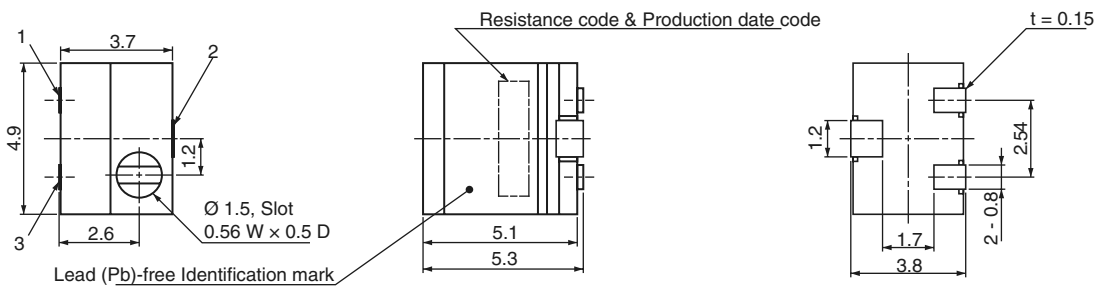

PACKAGING SPECIFICATIONS

Taping packaging specifications

- Taping version (SM-4TA, TB, ETA, ETB types) are packaged in 500 pcs. per reel.
Orders will be accepted for units of 500 pcs., i.e., 500, 1000, 1500 pcs., etc.
SM-4TW, ETW types are packaged in 250 pcs. per reel.
Orders will be accepted for units of 250 pcs., i.e., 500, 750 pcs., etc.
- Taping version is boxed with one reel.

Maximum number of consecutive missing pieces = 2

Leader length and reel dimension are shown in the dia-grams below.

EMBOSSED TAPE DIMENSIONS

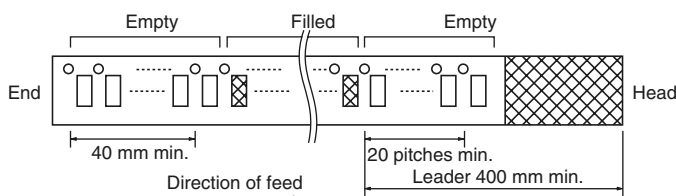

REEL DIMENSIONS

(Conforms to JIS C 0806-3)

(TA/TB type : In accordance with EIAJ ET-7200A)

(Unit: mm)

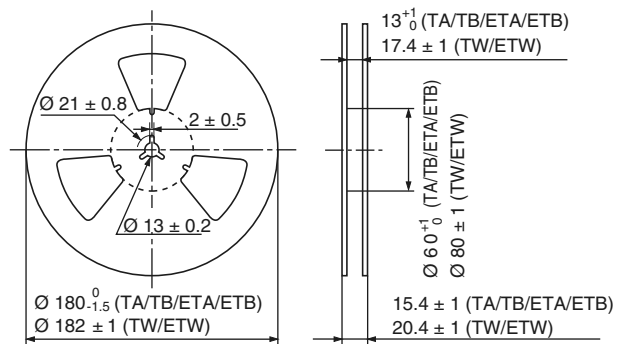

SM-4TA/TB/ETA/ETB

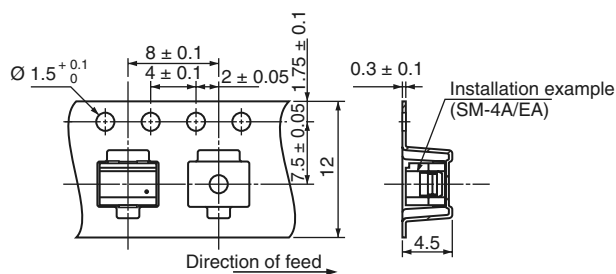

SM-4TW/ETW

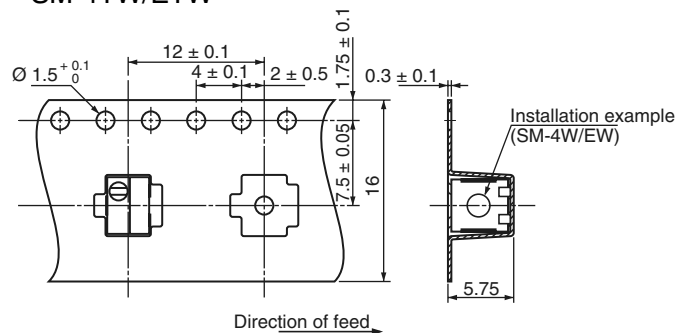

Vinyl bag packaging specifications

- Unit of bulk in vinyl bag packaging is 50 pcs. per pack.
- Boxing of bulk in vinyl bags is performed with 200 pcs. per box.

MECHANICAL SPECIFICATIONS

Mechanical turn	12 turns
Operating torque	20 mN m {204 gf cm} maximum
Mechanical stop	Clutch action
Rotational life	200 cycles [$\Delta R/R \leq \pm (3 \Omega + 3 \%)$]
Thrust to shaft	5 N {0.51 kgf} minimum
Solderability	Sn-Pb: 235 °C, 2 s Sn-Cu (Lead (Pb)-free): 245 ± 3 °C, 2 ~ 3 s
Shear (Adhesion)	5 N {0.51 kgf} 10 s
Substrate bending	Width 90 mm, bend 3 mm, 5 s, 1 time
Pull-off strength	5 N {0.51 kgf} 10 s

ELECTRICAL CHARACTERISTICS

Nominal resistance range	10 Ω ~ 2 M Ω
Resistance tolerance	± 10 %
Power ratings	0.25 W (85 °C) 0 W (150 °C)
Resistance law	Linear law (B)
Maximum input voltage	DC300 V or power rating, whichever is smaller
Maximum wiper current	100 mA or power rating, whichever is smaller
Effective electrical turn	10 turns
End resistance	1 % or 2 Ω , whichever is greater
C.R.V.	1 % or 3 Ω , whichever is greater
Operating temp. range	- 6 ~ 150 °C
Temp. coefficient	± 100 10 ⁻⁶ /°C maximum
Insulation resistance	1000 M Ω minimum (DC500 V)
Dielectric strength	AC600 V, 60 s
Net weight	Approx. 0.2 g

ENVIRONMENTAL SPECIFICATIONS

Test item	Test conditions	Specifications
Thermal shock	- 65 ~ 150 °C (0.5 h), 5 cycles	[$\Delta R/R \leq 2 \%$] [S.S. ≤ 1 %]
Humidity	- 10 ~ 65 °C (Relative humidity 80 ~ 98 %), 10 cycles, 240 h	[$\Delta R/R \leq 2 \%$]
Shock	981 m/s ² , 6 ms 6 directions for 3 times each	[$\Delta R/R \leq 1 \%$] [S.S. ≤ 1 %]
Vibration	Amplitude 1.52 mm or Acceleration 196 m/s ² , 10 ~ 2000Hz, 3 directions, 12 times each	
Load Life	85 °C, 0.25 W, 1000 h	[$\Delta R/R \leq 2 \%$] [S.S. ≤ 1 %]
Low temperature operation	- 65 °C, 2 h	[$\Delta R/R \leq 1 \%$] [S.S. ≤ 1 %]
High temperature exposure	150 °C, 250 h	[$\Delta R/R \leq 2 \%$] [S.S. ≤ 1 %]
Immersion seal	85 °C, 60 s	No leaks (No continuous bubbles)
Soldering heat	Sn-Pb 260 °C, 10 s or 215 °C, 35 s	[$\Delta R/R \leq 1 \%$]
	Sn-Cu Flow: 260 °C ± 3 °C as the temperature in a pot of molten solder, immersion from head of terminal to backside of board, 5 ~ 6 s, two times maximum Reflow: Peak temperature 255 °C (Please refer to the profile below.) Manual soldering: 350 ± 10 °C, 3 ~ 4 s	

Reflow profile for soldering heat evaluation

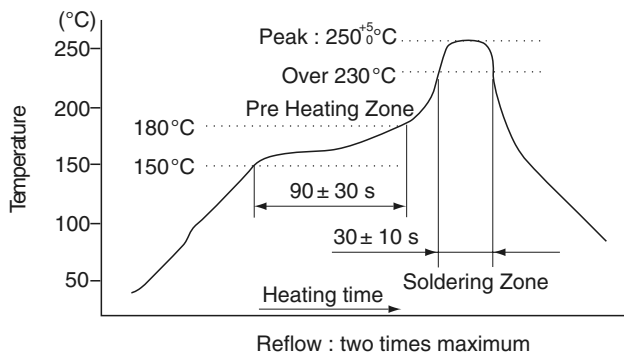

MAXIMUM INPUT RATINGS

Nominal resistance values (Ω)	Resistance code	Maximum input voltage (V)	Maximum wiper current (mA)
10*	100	1.00	100
20*	200	2.00	100
50	500	3.53	70.7
100	101	5.00	50.0
200	201	7.07	35.4
500	501	11.2	22.4
1 k	102	15.8	15.8
2 k	202	22.4	11.2
5 k	502	35.4	7.07
10 k	103	50.0	5.00
20 k	203	70.7	3.54
50 k	503	112	2.24
100 k	104	158	1.58
200 k	204	223	1.12
500 k	504	300	0.60
1 M	105	300	0.30
2 M	205	300	0.15

* The products indicated by * mark are manufactured upon receipt of order basis

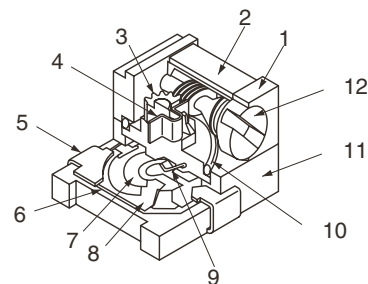
**CONSTRUCTION**

	Part Name	Material	Flammability
1	Housing	PPS (Polyphenylenesulp hide)	UL-94V-O
2	Cover	Stainless steel	-
3	Rotor gear	PPS (Polyphenylenesulp hide)	UL-94V-O
4	Clutch spring	Stainless steel	-
5	Terminal pin	Sn-Pb	Copper alloy, Solder-plated
		Sn-Cu	Copper, Sn-Cu-plated
6	Base element	Ceramic	-
7	Resistive element	RuO ₂ cermet	-
8	Electrode	Ag-Pd cermet	-
9	Wiper	Multi metal alloy	
10	"O" ring	Silicone rubber	UL-94HB
11	Base	Epoxy	UL-94V-O
12	Shaft	Metal	-

CFCs, Halon, Carbon tetrachloride and designated bromic flame retardant PBBs and PBBs are not used in our products.

LIST OF PART NUMBERS

Adjustment position	Shape of terminal	Form of packing			
		Taping (reel)		Vinyl bag	
		Sn-Pb	Sn-Pb (Lead (Pb)-free)	Sn-Pb	Sn-Pb (Lead (Pb)-free)
Top adjustment	W (J-hook)	SM-4TW	SM-4ETW	SM-4W	SM-4EW
Side adjustment	A (J-hook)	SM-4TA	SM-4ETA	SM-4A	SM-4EA
	B (Gull wing)	SM-4TB	SM-4ETB	SM-4B	SM-4EB
Pieces in package		TW, ETW: 250 pcs./reel TA, ETA: 500 pcs./reel TB, ETB: 500 pcs./reel		50 pcs./pack	



FIG. 1: NOMINAL RESISTANCE VALUES								
* 10 Ω	* 20 Ω	50 Ω	100 Ω	200 Ω	500 Ω	1 kΩ	2 kΩ	5kΩ
10 kΩ	20 kΩ	50 kΩ	100 kΩ	200 kΩ	500 kΩ	1 MΩ	2 MΩ	-

The products indicated by * mark are manufactured upon receipt of order basis

* The above part numbers are all available with the respective combination of <Nominal resistance values>.

* Verify the above part numbers when placing orders.

* Taping specification is not sold separately and must be purchased in reel units.

ORDERING INFO				
SM-4		T	A	204
SERIES NAME	TERMINAL PIN	FORM OF PACKAGING	PRODUCT SHAPE (SHAPE OF TERMINAL)	RESISTANCE CODE
	Blank: Sn-Pb	T: Taping (Reel)	A: J-hook	
	E: Sn-Cu (Lead (Pb)-free)	Blank: Bulk in vinyl bags	B: Gull wing	
			W: J-hook	

This product is manufactured by Copal Electronic Co. Ltd. of Tokyo, Japan and distributed by Vishay in North and South America only. This product is not available from Vishay outside of North or South America.



Notice

Specifications of the products displayed herein are subject to change without notice. Vishay Intertechnology, Inc., or anyone on its behalf, assumes no responsibility or liability for any errors or inaccuracies.

Information contained herein is intended to provide a product description only. No license, express or implied, by estoppel or otherwise, to any intellectual property rights is granted by this document. Except as provided in Vishay's terms and conditions of sale for such products, Vishay assumes no liability whatsoever, and disclaims any express or implied warranty, relating to sale and/or use of Vishay products including liability or warranties relating to fitness for a particular purpose, merchantability, or infringement of any patent, copyright, or other intellectual property right.

The products shown herein are not designed for use in medical, life-saving, or life-sustaining applications. Customers using or selling these products for use in such applications do so at their own risk and agree to fully indemnify Vishay for any damages resulting from such improper use or sale.