

SPECIFICATIONS
CSB63CR202C
OUTLINES DIMENSIONS

Notes:

1. All Dimensions are in millimeters (inches).
2. Tolerance is $\pm 0.25\text{mm}$ (0.01") unless otherwise noted.
3. Specifications are subject to change without notice.

Part Number	Chip Material	Color of Emission	Lens Type	Viewing Angle
CSB63CR202C	InGaAlP	Red/Orange	Water Clear	130°

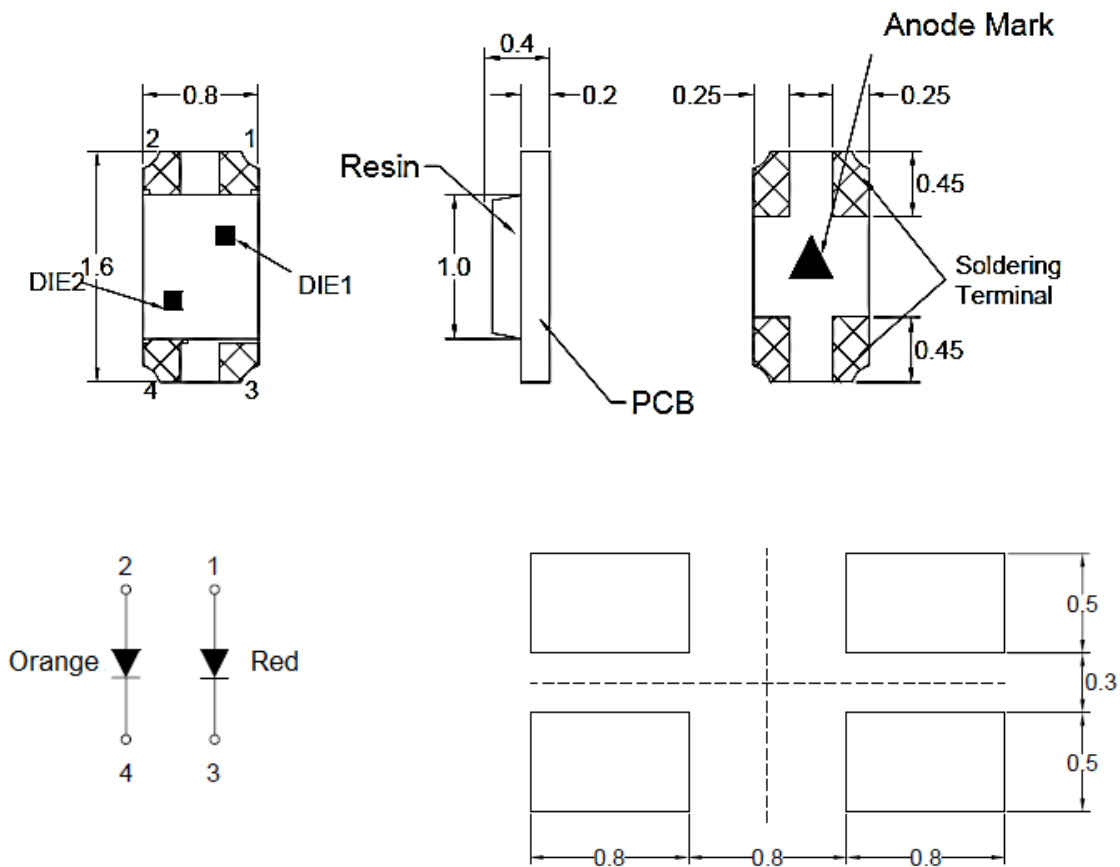

ChromeLED Corp. reserves the right to make changes at any time in order to supply the best product possible. The most current version of this document will always be available at: www.chromeled.com

ABSOLUTE MAXIMUM RATINGS
(TA=25°C)

Parameter	Symbol	Color	Max Rating	Unit
Power Dissipation	PD	Red	78	mW
		Orange		
Pulse Current Forward Current	IFP	Red	60	mA
		Orange		
Continuous Forward Current	IF	Red	30	mA
		Orange		
Reverse Voltage	VR	5		V
Operating Temperature Range	TOPR	-40~+85		°C
Storage Temperature Range	TSTG	-40~+100		°C

IFP = Pulse Width ≤ 10 ms, Duty Ratio ≤1/8. Soldering Condition: 260 °C/ 5sec

OPTICAL-ELECTRICAL CHARACTERISTICS
(TA=25°C)

Parameter	Symbol	Test Con- dition	Color	Value			Unit
				Min	Typ	Max	
Luminous Intensity	IV	IF = 20mA	Red	200	350	-	mcd
			Orange	320	500	-	
Forward Voltage	VF	IF = 20mA	Red	-	2.0	2.6	V
			Orange	-	2.0	2.6	
Reverse Leakage Current	IR	VR = 5V	Red	-	-	10	µA
			Orange	-	-	10	
Viewing Angle	2θ1/2	IF = 10mA	Red	-	120	-	deg
			Orange	-	120	-	
Dominant Wavelength	λD	IF = 20mA	Red	618	-	630	nm
			Orange	598	-	606	

*Tolerance of viewing angle: -10 / +5 deg.



ChromeLED Corp. reserves the right to make changes at any time in order to supply the best product possible. The most current version of this document will always be available at: www.chromeled.com

OPTICAL CHARACTERISTIC CURVES (RED)

Fig.1 Forward current vs. Forward Voltage

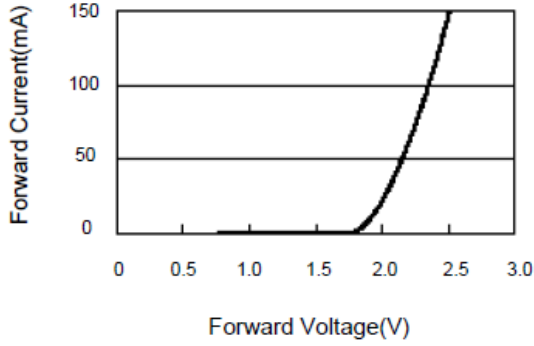

Fig.2 Luminous Intensity vs. Forward Current

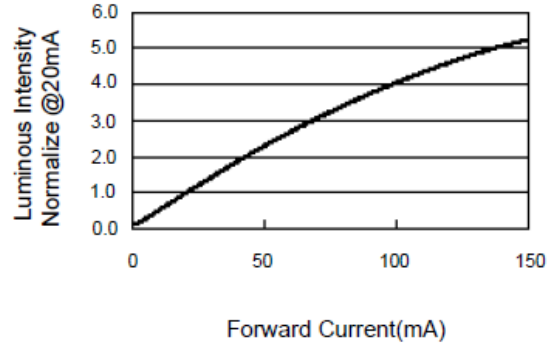

Fig.3 Forward Voltage vs. Temperature

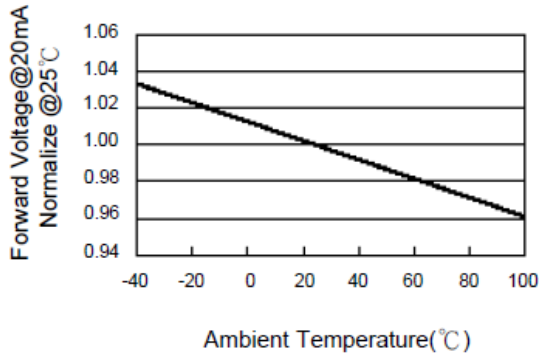

Fig.4 Luminous Intensity vs. Temperature

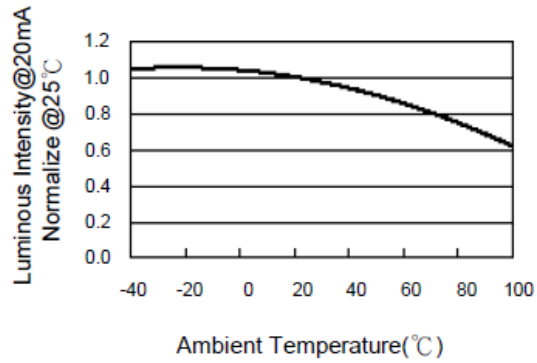

Fig.5 Relative Intensity vs. Wavelength

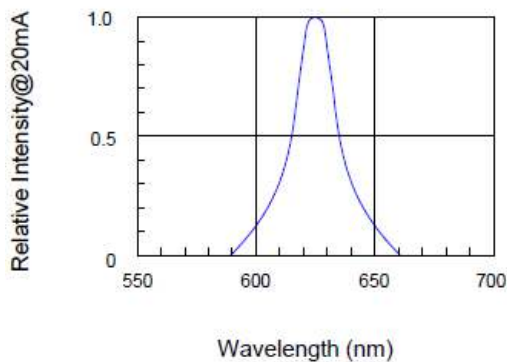
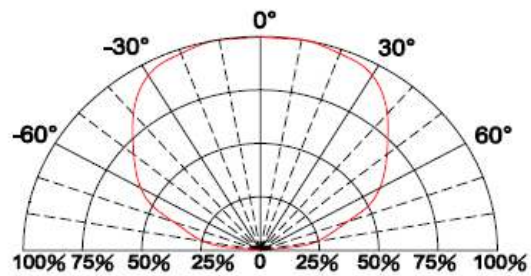

Fig.6 Directive Radiation



ChromeLED Corp. reserves the right to make changes at any time in order to supply the best product possible. The most current version of this document will always be available at: www.chromeled.com

OPTICAL CHARACTERISTIC CURVES (ORANGE)

Fig.1 Forward current vs. Forward Voltage

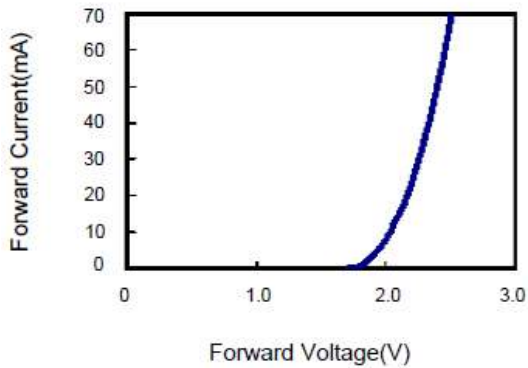

Fig.2 Relative Intensity vs. Forward Current

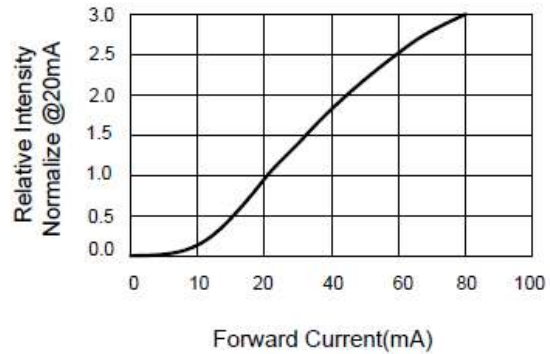

Fig.3 Forward Voltage vs. Temperature

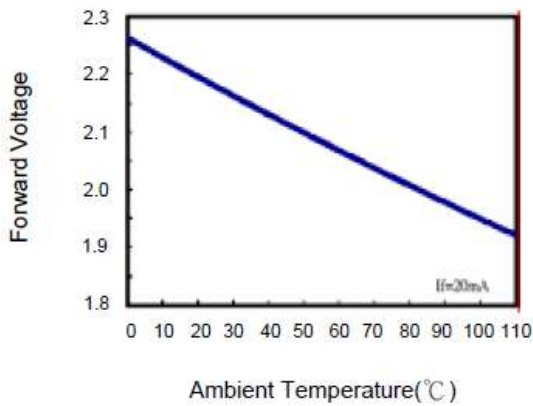

Fig.4 Relative Intensity vs. Temperature

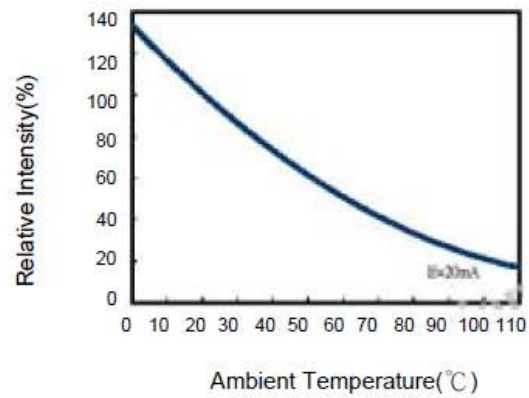

Fig.5 Relative Intensity vs. Wavelength

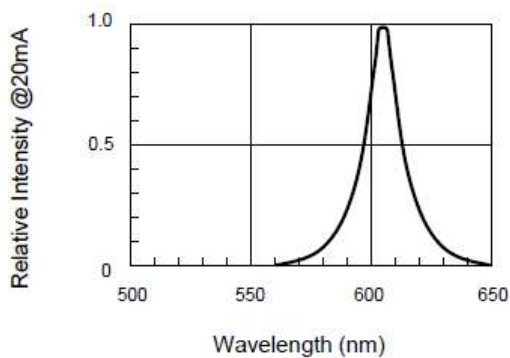
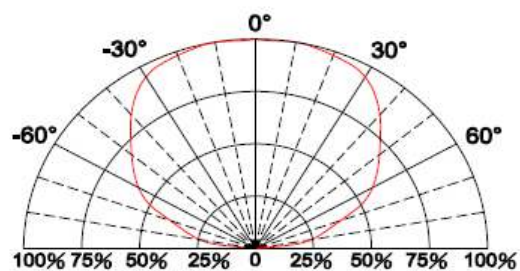

Fig.6 Directive Radiation



ChromeLED Corp. reserves the right to make changes at any time in order to supply the best product possible. The most current version of this document will always be available at: www.chromeled.com

SOLDERING CONDITIONS

RECOMMENDED SOLDERING CONDITIONS

1. Hand Solder

Basic spec is $\leq 280^{\circ}\text{C}$ 3 sec one time only.

3. PB-Free Reflow Solder

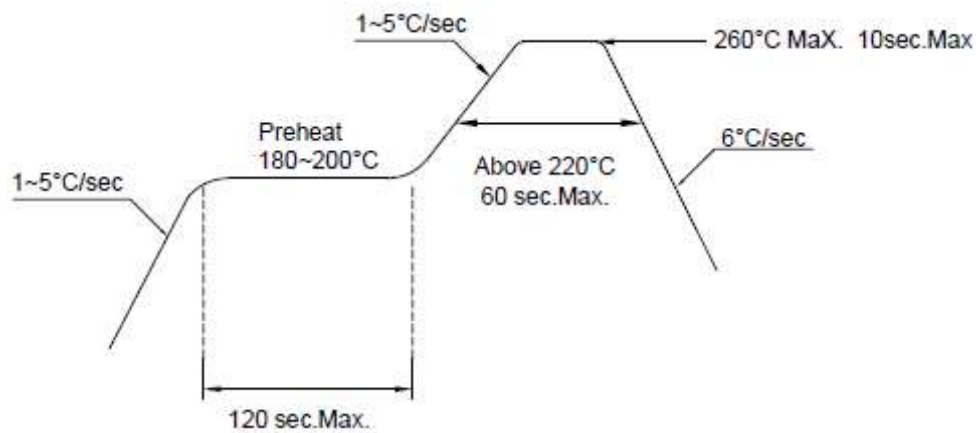

Notes:

1. Reflow soldering should not be done more than two times.
2. When soldering, do not put stress on the LEDs during heating.
3. After soldering, do not warp the circuit board.



ChromeLED Corp. reserves the right to make changes at any time in order to supply the best product possible. The most current version of this document will always be available at: www.chromeled.com

PACKAGING SPECIFICATIONS

CARRIER TAPE DIMENSION

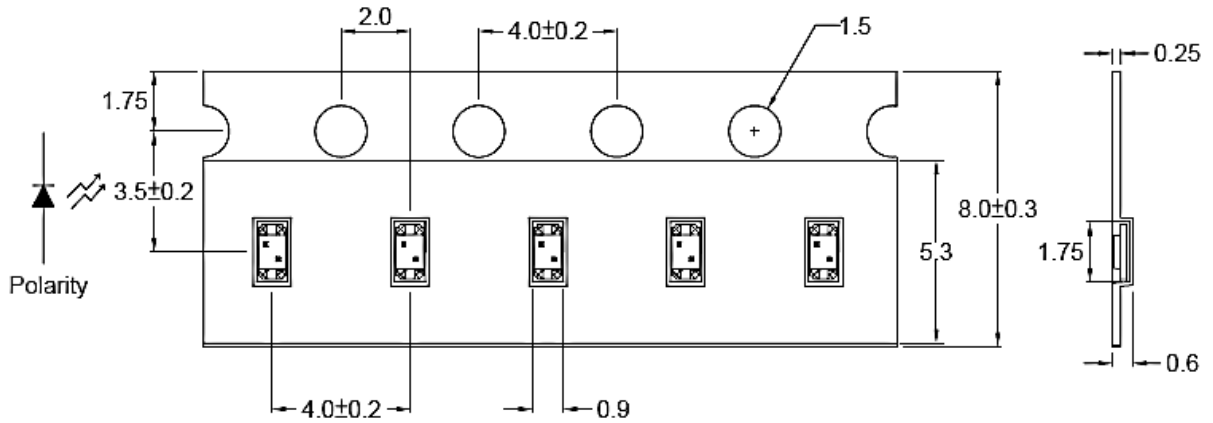

Note: The tolerances unless mentioned are ±0.1mm, Angle ±0.5; Unit=mm

REEL DIMENSIONS

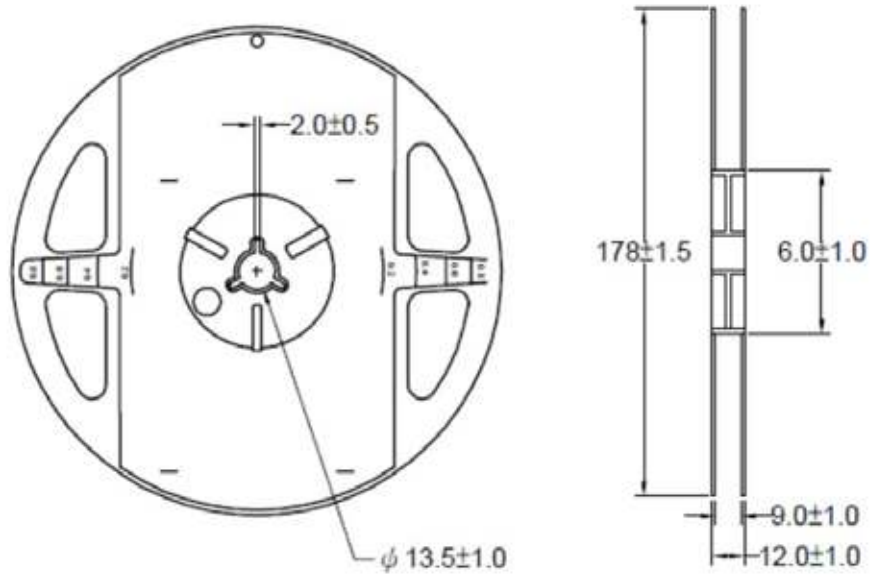

Notes:

1. 4,000 pieces per reel.
2. 8.0mm tape, 7" reel



ChromeLED Corp. reserves the right to make changes at any time in order to supply the best product possible. The most current version of this document will always be available at: www.chromeled.com