

OSRAM LY M67F

Datasheet

Discontinued

Published by ams-OSRAM AG

Tobelbader Strasse 30, 8141 Premstaetten, Austria

Phone +43 3136 500-0

ams-osram.com

© All rights reserved



Mini TOPLED®

LY M67F



Applications

- Ambient Lighting
- Automotive Aftermarket
- Robotics

Features

- Package: SMD epoxy package
- Chip technology: Thinfilm
- Typ. Radiation: 120° (Lambertian emitter)
- Color: $\lambda_{\text{dom}} = 590 \text{ nm}$ (● yellow)
- Corrosion Robustness Class: 3B
- Qualifications: The product qualification test plan is based on the guidelines of AEC-Q101-REV-C, Stress Test Qualification for Automotive Grade Discrete Semiconductors.
- ESD: 2 kV acc. to ANSI/ESDA/JEDEC JS-001 (HBM, Class 2)

Ordering Information

| Type | Luminous Intensity ¹⁾ $I_F = 20 \text{ mA}$ I_v | Ordering Code |
|-----------------|--|---------------|
| LY M67F-T2V2-36 | 355 ... 1120 mcd | Q65110A8980 |

Maximum Ratings

| Parameter | Symbol | | Values |
|--|-----------|------|--------|
| Operating Temperature | T_{op} | min. | -40 °C |
| | | max. | 100 °C |
| Storage Temperature | T_{stg} | min. | -40 °C |
| | | max. | 100 °C |
| Junction Temperature | T_j | max. | 125 °C |
| Forward current $T_s = 25\text{ °C}$ | I_F | max. | 30 mA |
| Surge current $t \leq 10\ \mu\text{s}$; $D = 0.005$; $T_s = 25\text{ °C}$ | I_{FS} | max. | 100 mA |
| Reverse voltage ²⁾ $T_s = 25\text{ °C}$ | V_R | max. | 12 V |
| ESD withstand voltage acc. to ANSI/ESDA/JEDEC JS-001 (HBM, Class 2) | V_{ESD} | | 2 kV |

Characteristics

$I_F = 20 \text{ mA}$; $T_S = 25 \text{ }^\circ\text{C}$

| Parameter | Symbol | | Values |
|---|-------------------------------------|----------------------|--|
| Peak Wavelength | λ_{peak} | typ. | 597 nm |
| Dominant Wavelength ³⁾ $I_F = 20 \text{ mA}$ | λ_{dom} | min. typ. max. | 583 nm 590 nm 595 nm |
| Spectral Bandwidth at 50% $I_{\text{rel,max}}$ | $\Delta\lambda$ | typ. | 18 nm |
| Viewing angle at 50% I_V | 2ϕ | typ. | 120 ° |
| Forward Voltage ⁴⁾ $I_F = 20 \text{ mA}$ | V_F | min. typ. max. | 1.90 V 2.20 V 2.50 V |
| Reverse current ²⁾ $V_R = 12 \text{ V}$ | I_R | typ. max. | 0.01 μA 10 μA |
| Temperature Coefficient of Peak Wavelength $-10^\circ\text{C} \leq T \leq 100^\circ\text{C}$ | $\text{TC}_{\lambda_{\text{peak}}}$ | typ. | 0.12 nm / K |
| Temperature Coefficient of Dominant Wavelength $-10^\circ\text{C} \leq T \leq 100^\circ\text{C}$ | $\text{TC}_{\lambda_{\text{dom}}}$ | typ. | 0.1 nm / K |
| Temperature Coefficient of Forward Voltage $-10^\circ\text{C} \leq T \leq 100^\circ\text{C}$ | TC_{V_F} | typ. | -2.5 mV / K |
| Real thermal resistance junction/ambient ⁵⁾⁶⁾ | $R_{\text{thJA real}}$ | max. | 580 K / W |
| Real thermal resistance junction/solderpoint ⁵⁾ | $R_{\text{thJS real}}$ | max. | 330 K / W |

Brightness Groups

| Group | Luminous Intensity ¹⁾ $I_F = 20 \text{ mA}$ min. I_v | Luminous Intensity ¹⁾ $I_F = 20 \text{ mA}$ max. I_v | Luminous Flux ⁷⁾ $I_F = 20 \text{ mA}$ typ. Φ_v |
|-------|--|--|--|
| T2 | 355 mcd | 450 mcd | 1210 mlm |
| U1 | 450 mcd | 560 mcd | 1520 mlm |
| U2 | 560 mcd | 710 mcd | 1910 mlm |
| V1 | 710 mcd | 900 mcd | 2420 mlm |
| V2 | 900 mcd | 1120 mcd | 3030 mlm |

Forward Voltage Groups

| Group | Forward Voltage ⁴⁾ $I_F = 20 \text{ mA}$ min. V_F | Forward Voltage ⁴⁾ $I_F = 20 \text{ mA}$ max. V_F |
|-------|---|---|
| G3 | 1.90 V | 2.05 V |
| K3 | 2.05 V | 2.20 V |
| N3 | 2.20 V | 2.35 V |
| R3 | 2.35 V | 2.50 V |

Wavelength Groups

| Group | Dominant Wavelength ³⁾ $I_F = 20 \text{ mA}$ min. λ_{dom} | Dominant Wavelength ³⁾ $I_F = 20 \text{ mA}$ max. λ_{dom} |
|-------|--|--|
| 3 | 583 nm | 586 nm |
| 4 | 586 nm | 589 nm |
| 5 | 589 nm | 592 nm |
| 6 | 592 nm | 595 nm |

Group Name on Label

Example: T2-3-G3

| Brightness | Wavelength | Forward Voltage |
|------------|------------|-----------------|
| T2 | 3 | G3 |

Relative Spectral Emission ⁷⁾

$I_{rel} = f(\lambda); I_F = 20 \text{ mA}; T_S = 25 \text{ }^\circ\text{C}$

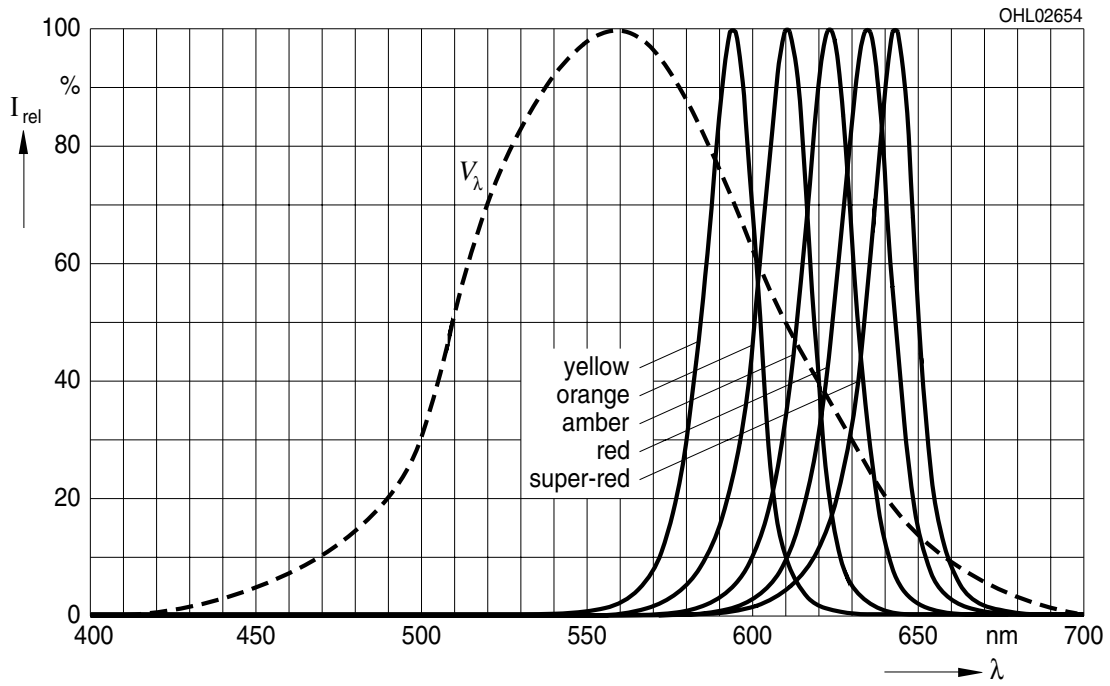

Radiation Characteristics ⁷⁾

$I_{rel} = f(\phi); T_S = 25 \text{ }^\circ\text{C}$

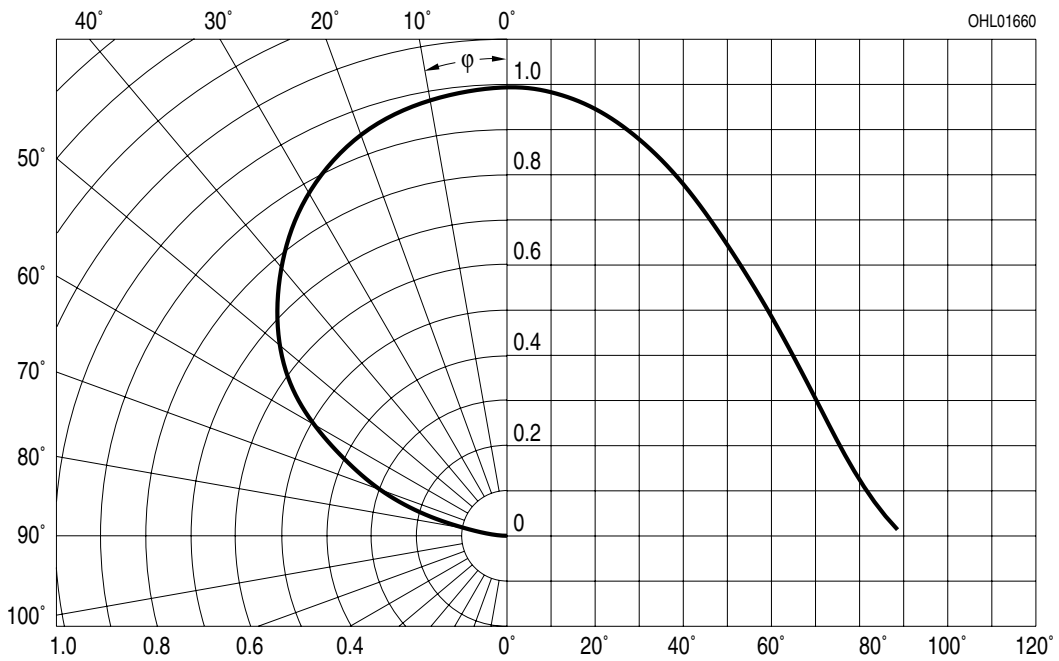

Discontinued

Forward current ^{7), 8)}

$I_F = f(V_F); T_S = 25\text{ °C}$

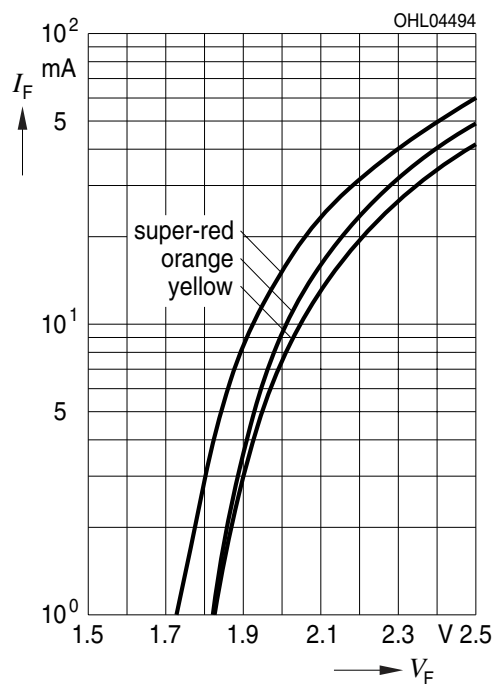

Relative Luminous Intensity ^{7), 8)}

$I_V/I_V(20\text{ mA}) = f(I_F); T_S = 25\text{ °C}$

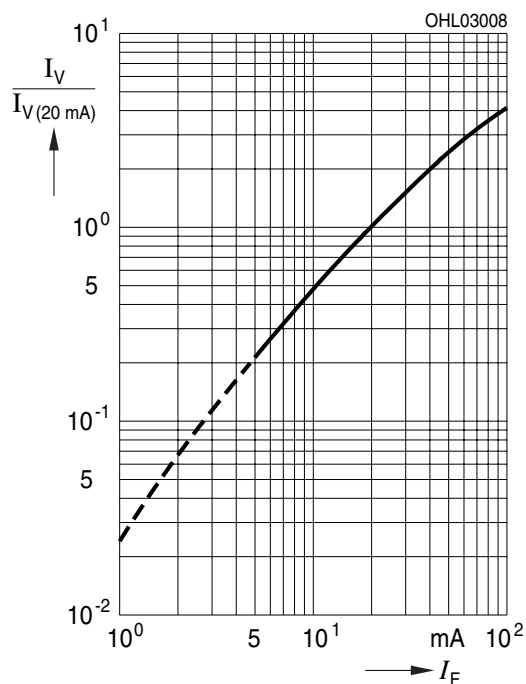

Forward Voltage ⁷⁾

$$\Delta V_F = V_F - V_F(25\text{ °C}) = f(T_j); I_F = 20\text{ mA}$$

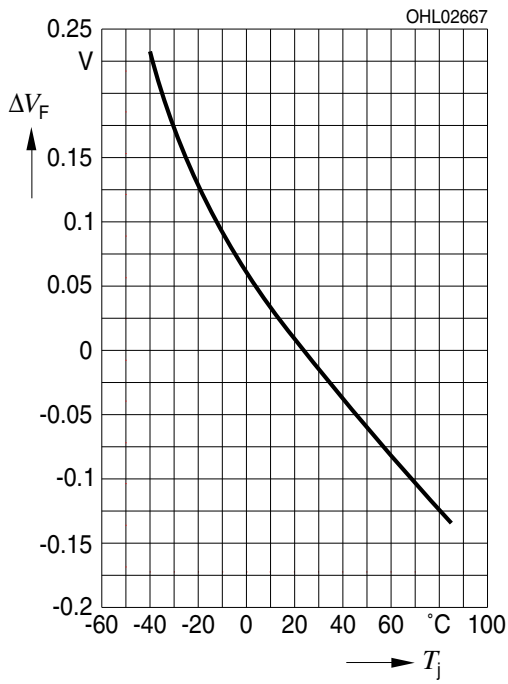

Relative Luminous Intensity ⁷⁾

$$I_V/I_V(25\text{ °C}) = f(T_j); I_F = 20\text{ mA}$$

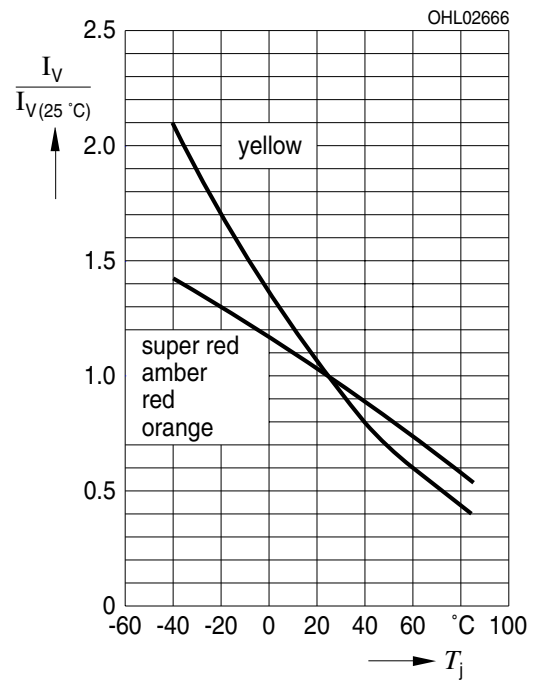

Max. Permissible Forward Current

$I_F = f(T)$

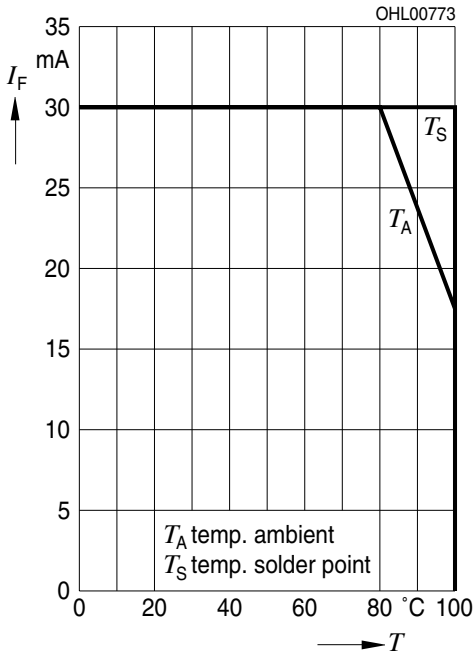

Permissible Pulse Handling Capability

$I_F = f(t_p)$; D: Duty cycle; $T_S = 25\text{ °C}$

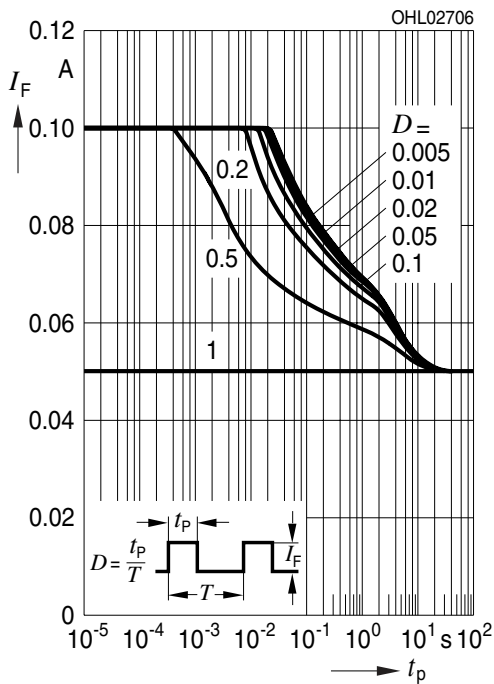

Permissible Pulse Handling Capability

$I_F = f(t_p)$; D: Duty cycle; $T_S = 85\text{ °C}$

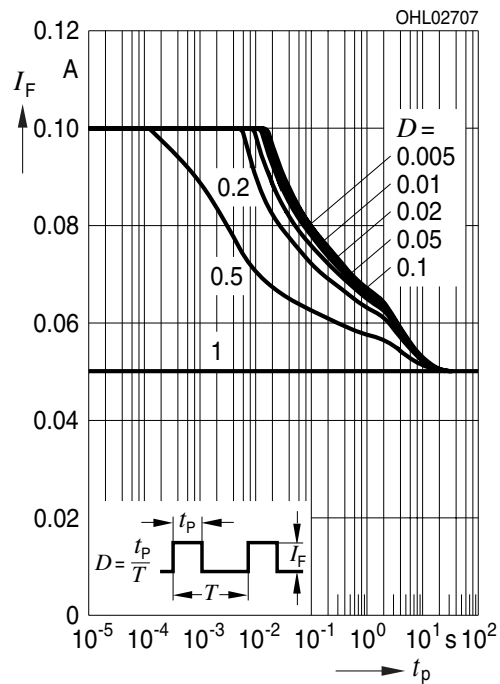

Discontinued

Dimensional Drawing ⁹⁾

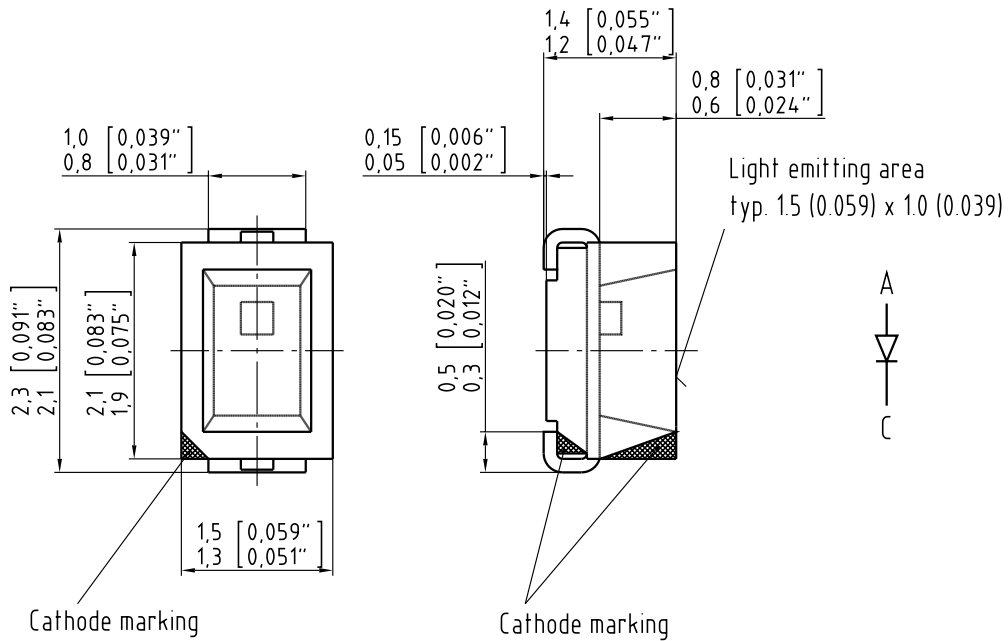

C63062-A3740-A1.. -05

Further Information:

Approximate Weight: 7.0 mg

Package marking: Cathode

Corrosion test: Class: 3B

Test condition: 40°C / 90 % RH / 15 ppm H₂S / 14 days (stricter than IEC 60068-2-43)

Recommended Solder Pad ⁹⁾

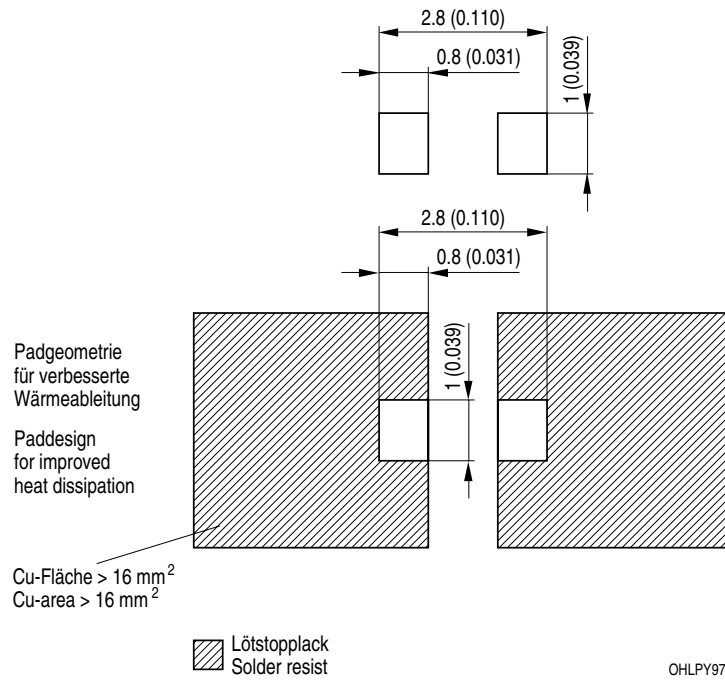

For superior solder joint connectivity results we recommend soldering under standard nitrogen atmosphere. Package not suitable for ultra sonic cleaning.

Reflow Soldering Profile

Product complies to MSL Level 2 acc. to JEDEC J-STD-020E

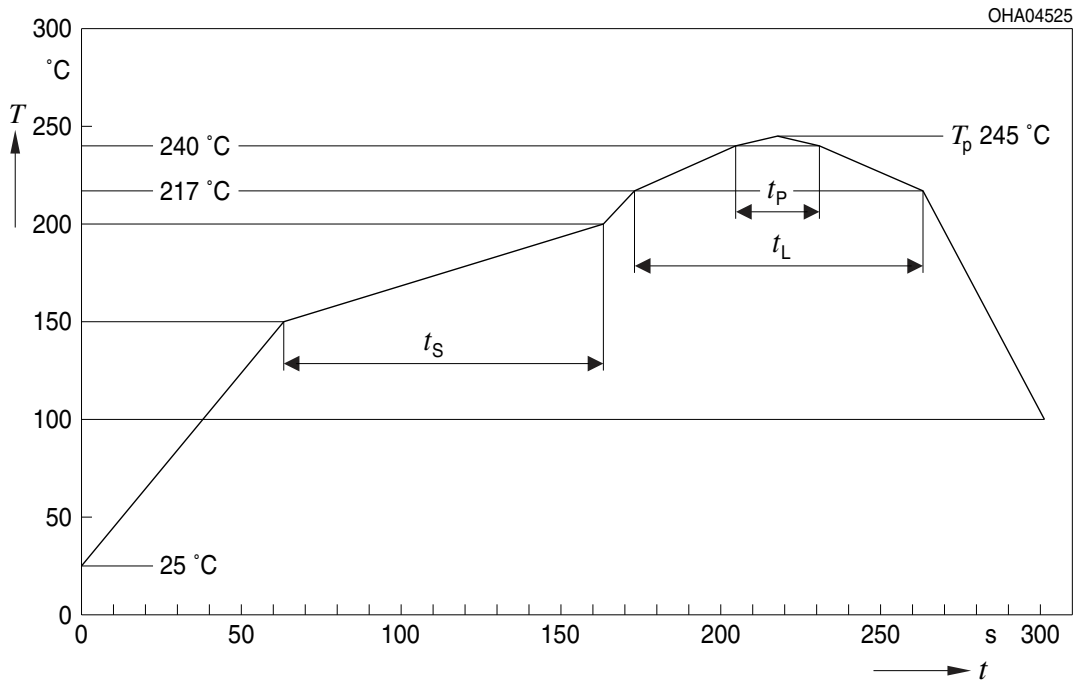

| Profile Feature | Symbol | Pb-Free (SnAgCu) Assembly | | | Unit |
|--|--------|---------------------------|----------------|---------|------|
| | | Minimum | Recommendation | Maximum | |
| Ramp-up rate to preheat ^{*)} 25 °C to 150 °C | | | 2 | 3 | K/s |
| Time t_s T_{Smin} to T_{Smax} | t_s | 60 | 100 | 120 | s |
| Ramp-up rate to peak ^{*)} T_{Smax} to T_p | | | 2 | 3 | K/s |
| Liquidus temperature | T_L | | 217 | | °C |
| Time above liquidus temperature | t_L | | 80 | 100 | s |
| Peak temperature | T_p | | 245 | 260 | °C |
| Time within 5 °C of the specified peak temperature $T_p - 5$ K | t_p | 10 | 20 | 30 | s |
| Ramp-down rate* T_p to 100 °C | | | 3 | 6 | K/s |
| Time 25 °C to T_p | | | | 480 | s |

All temperatures refer to the center of the package, measured on the top of the component
 *) slope calculation DT/Dt : Dt max. 5 s; fulfillment for the whole T-range

Discontinued

Taping ⁹⁾

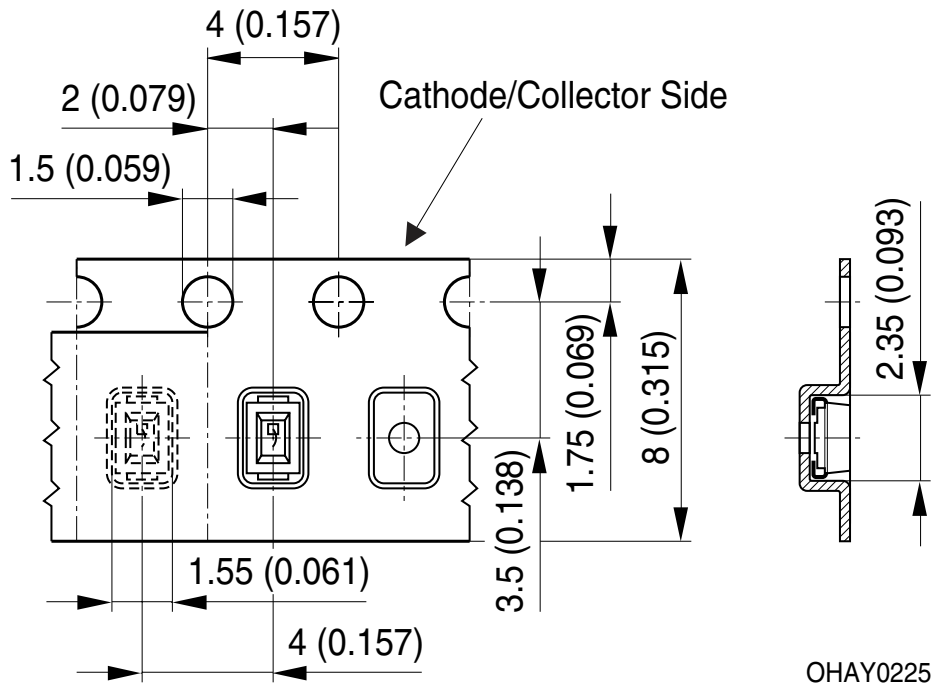

Tape and Reel ¹⁰⁾

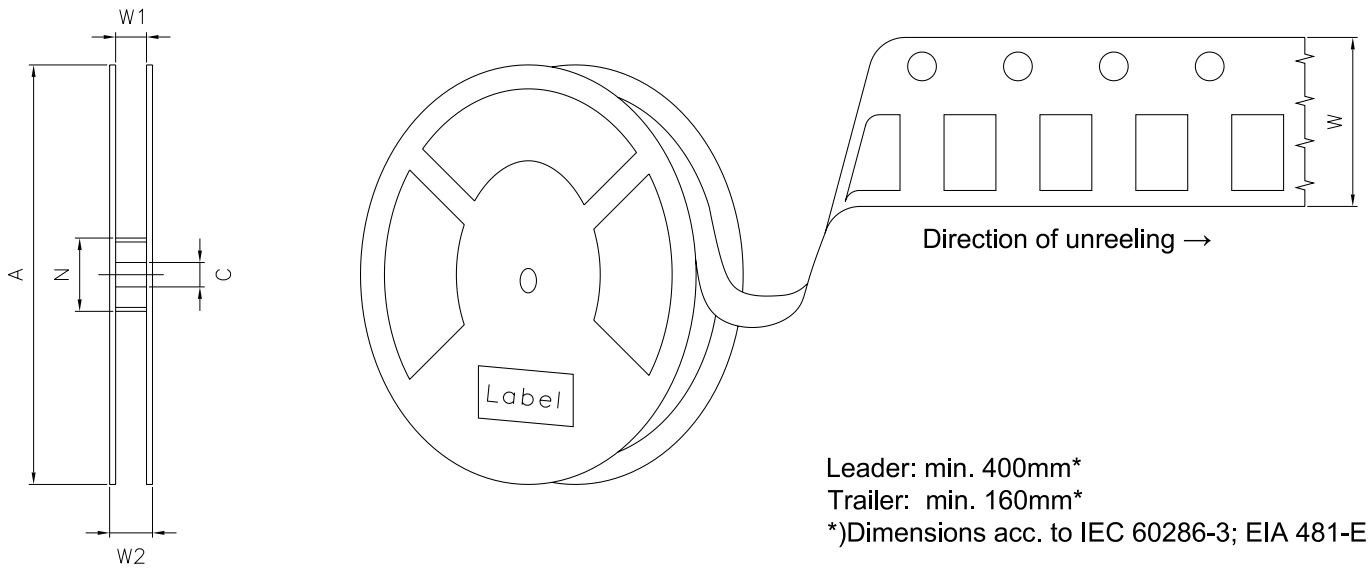

Reel Dimensions

| A | W | N_{\min} | W_1 | $W_{2\max}$ | Pieces per PU |
|--------|----------------------|------------|--------------|-------------|---------------|
| 180 mm | $8 + 0.3 / - 0.1$ mm | 60 mm | $8.4 + 2$ mm | 14.4 mm | 3000 |

Barcode-Product-Label (BPL)



OSRAM Opto Semiconductors LX XXXX BIN1: XX-XX-X-XXX-X

RoHS Compliant

(6P) BATCH NO: 1234567890 ML Temp ST
X XXX °C X

(1T) LOT NO: 1234567890 (9D) D/C: 1234

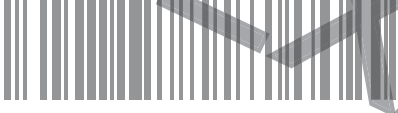
Pack: RXX
DEMY XXX
X_X123_1234.1234 X

(X) PROD NO: 123456789(Q)QTY: 9999 (G) GROUP: XX-XX-X-X

OHA04563

Dry Packing Process and Materials ⁹⁾

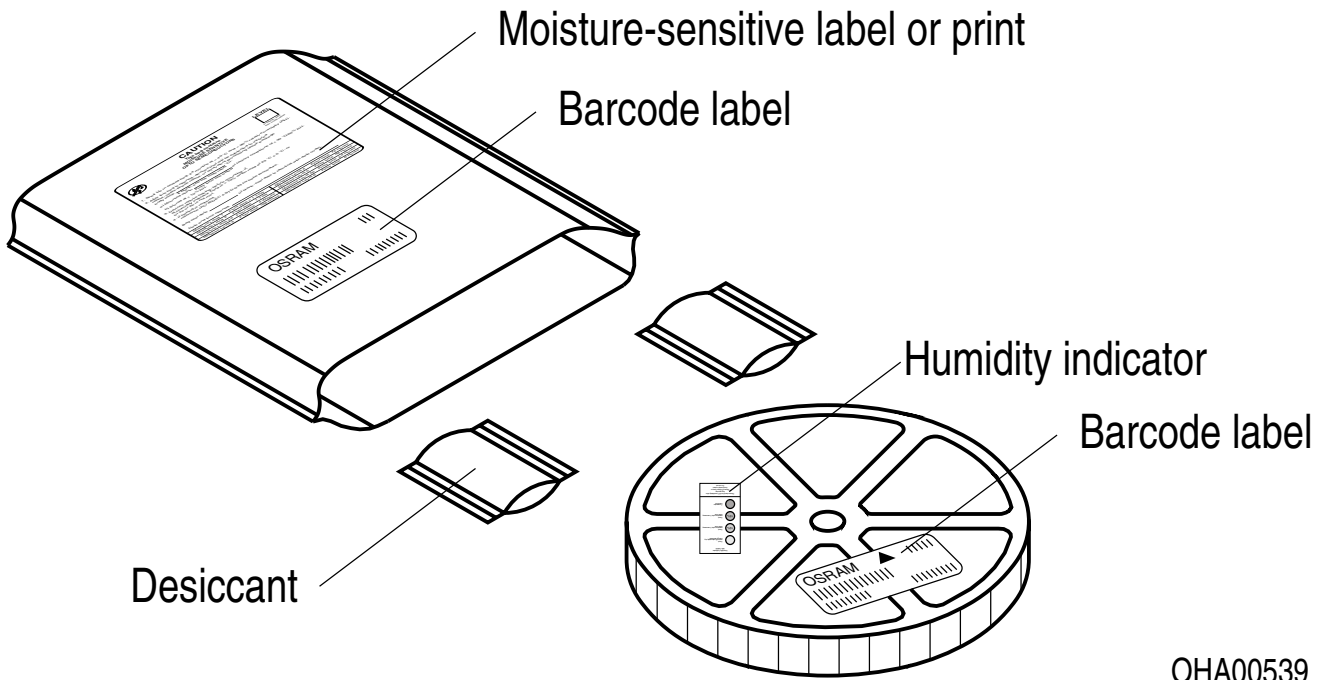

OHA00539

Moisture-sensitive product is packed in a dry bag containing desiccant and a humidity card according JEDEC-STD-033.

Discontinued

Notes

The evaluation of eye safety occurs according to the standard IEC 62471:2006 (photo biological safety of lamps and lamp systems). Within the risk grouping system of this IEC standard, the device specified in this data sheet fall into the class **exempt group (exposure time 10000 s)**. Under real circumstances (for exposure time, conditions of the eye pupils, observation distance), it is assumed that no endangerment to the eye exists from these devices. As a matter of principle, however, it should be mentioned that intense light sources have a high secondary exposure potential due to their blinding effect. When looking at bright light sources (e.g. headlights), temporary reduction in visual acuity and afterimages can occur, leading to irritation, annoyance, visual impairment, and even accidents, depending on the situation.

Subcomponents of this device contain, in addition to other substances, metal filled materials including silver. Metal filled materials can be affected by environments that contain traces of aggressive substances. Therefore, we recommend that customers minimize device exposure to aggressive substances during storage, production, and use. Devices that showed visible discoloration when tested using the described tests above did show no performance deviations within failure limits during the stated test duration. Respective failure limits are described in the IEC60810.

For further application related information please visit www.osram-os.com/appnotes

Disclaimer

Attention please!

The information describes the type of component and shall not be considered as assured characteristics. Terms of delivery and rights to change design reserved. Due to technical requirements components may contain dangerous substances.

For information on the types in question please contact our Sales Organization.

If printed or downloaded, please find the latest version on our website.

Packing

Please use the recycling operators known to you. We can also help you – get in touch with your nearest sales office. By agreement we will take packing material back, if it is sorted. You must bear the costs of transport. For packing material that is returned to us unsorted or which we are not obliged to accept, we shall have to invoice you for any costs incurred.

Product and functional safety devices/applications or medical devices/applications

Our components are not developed, constructed or tested for the application as safety relevant component or for the application in medical devices.

Our products are not qualified at module and system level for such application.

In case buyer – or customer supplied by buyer – considers using our components in product safety devices/ applications or medical devices/applications, buyer and/or customer has to inform our local sales partner immediately and we and buyer and /or customer will analyze and coordinate the customer-specific request between us and buyer and/or customer.

Glossary

- 1) **Brightness:** Brightness values are measured during a current pulse of typically 25 ms, with an internal reproducibility of $\pm 8\%$ and an expanded uncertainty of $\pm 11\%$ (acc. to GUM with a coverage factor of $k = 3$).
- 2) **Reverse Operation:** This product is intended to be operated applying a forward current within the specified range. Applying any continuous reverse bias or forward bias below the voltage range of light emission shall be avoided because it may cause migration which can change the electro-optical characteristics or damage the LED.
- 3) **Wavelength:** The wavelength is measured at a current pulse of typically 25 ms, with an internal reproducibility of ± 0.5 nm and an expanded uncertainty of ± 1 nm (acc. to GUM with a coverage factor of $k = 3$).
- 4) **Forward Voltage:** The forward voltage is measured during a current pulse of typically 8 ms, with an internal reproducibility of ± 0.05 V and an expanded uncertainty of ± 0.1 V (acc. to GUM with a coverage factor of $k = 3$).
- 5) **Thermal Resistance:** $R_{th\ max}$ is based on statistic values (6σ).
- 6) **Thermal Resistance:** R_{thJA} results from mounting on PC board FR 4 (pad size 16 mm² per pad)
- 7) **Typical Values:** Due to the special conditions of the manufacturing processes of semiconductor devices, the typical data or calculated correlations of technical parameters can only reflect statistical figures. These do not necessarily correspond to the actual parameters of each single product, which could differ from the typical data and calculated correlations or the typical characteristic line. If requested, e.g. because of technical improvements, these typ. data will be changed without any further notice.
- 8) **Characteristic curve:** In the range where the line of the graph is broken, you must expect higher differences between single devices within one packing unit.
- 9) **Tolerance of Measure:** Unless otherwise noted in drawing, tolerances are specified with ± 0.1 and dimensions are specified in mm.
- 10) **Tape and Reel:** All dimensions and tolerances are specified acc. IEC 60286-3 and specified in mm.

Revision History

| Version | Date | Change |
|---------|------------|--|
| 1.5 | 2022-09-28 | New Layout Applications Discontinued |

Discontinued



EU RoHS and China RoHS compliant product

此产品符合欧盟 RoHS 指令的要求；
按照中国的相关法规和标准，
不含有毒有害物质或元素。

Published by ams-OSRAM AG

Tobelbader Strasse 30, 8141 Premstaetten, Austria

Phone +43 3136 500-0

ams-osram.com

© All rights reserved

am 

OSRAM