

Features

- Lead Free Finish/RoHS Compliant(Note 1) ("P" Suffix Designates Compliant. See Ordering Information)
- Guardring For Overvoltage Protection
- High Forward Surge Capability
- Halogen Free Available Upon Request By Adding Suffix "-HF"
- Epoxy Meets UL 94 V-0 Flammability Rating

Maximum Ratings

- Operating Junction Temperature Range: -55°C to +125°C(SB220L-SB240L)
- Operating Junction Temperature Range: -55°C to +150°C(SB250L-SB2010L)
- Storage Temperature Range: -55°C to +150°C
- Maximum Thermal Resistance: 45°C/W Junction to Ambient

MCC Part Number	Device Marking	Maximum Recurrent Peak Reverse Voltage	Maximum RMS Voltage	Maximum DC Blocking Voltage
SB220L	SB220L	20V	14V	20V
SB230L	SB230L	30V	21V	30V
SB240L	SB240L	40V	28V	40V
SB250L	SB250L	50V	35V	50V
SB260L	SB260L	60V	42V	60V
SB280L	SB280L	80V	56V	80V
SB2010L	SB2010L	100V	70V	100V

Electrical Characteristics @ 25°C Unless Otherwise Specified

Average Rectified Output Current	I_o	2.0A	See Fig. 1
Maximum Surge Current	I_{FSM}	35A	8.3ms, Half Sine
Max Peak Forward Voltage	V_{FM}	0.45V	$I_{FM}=2.0A;$
SB220L-SB240L		0.48V	
SB250L-SB260L		0.75V	
Max Peak Reverse Current	I_{RM}	0.1mA 10mA	$T_J=25^{\circ}C;$ $T_J=100^{\circ}C$
Typical Junction Capacitance	C_J	180pF	$V_R=4.0V$ $f=1.0MHz$

Note : 1. High Temperature Solder Exemptions Applied, see EU Directive Annex 7a.

2.0 Amp Schottky Rectifier 20 to 100 Volts

DO-15

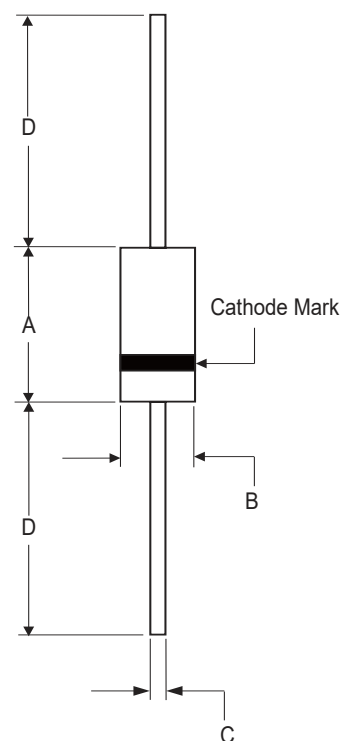

DIM	DIMENSIONS				NOTE
	INCHES		MM		
	MIN	MAX	MIN	MAX	
A	0.230	0.300	5.80	7.60	
B	0.104	0.140	2.60	3.60	
C	0.026	0.035	0.70	0.90	
D	1.000	-----	25.40	-----	

Curve Characteristics

Fig. 1 - Forward Current Derating Curve

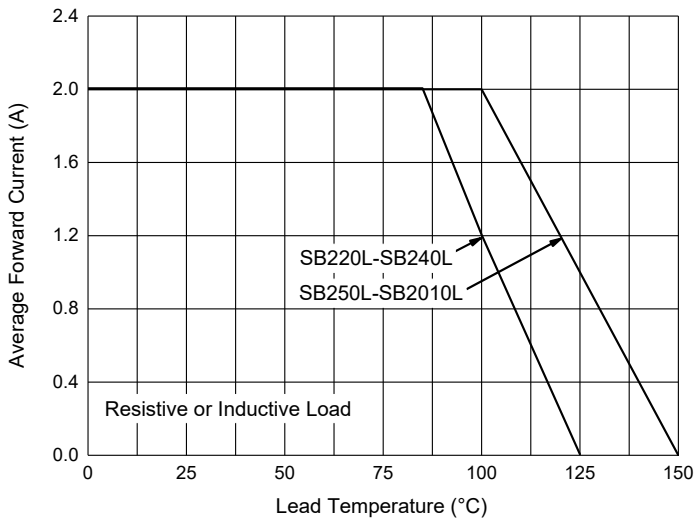

Fig. 2 - Maximum Non-Repetitive Peak Forward Surge Current

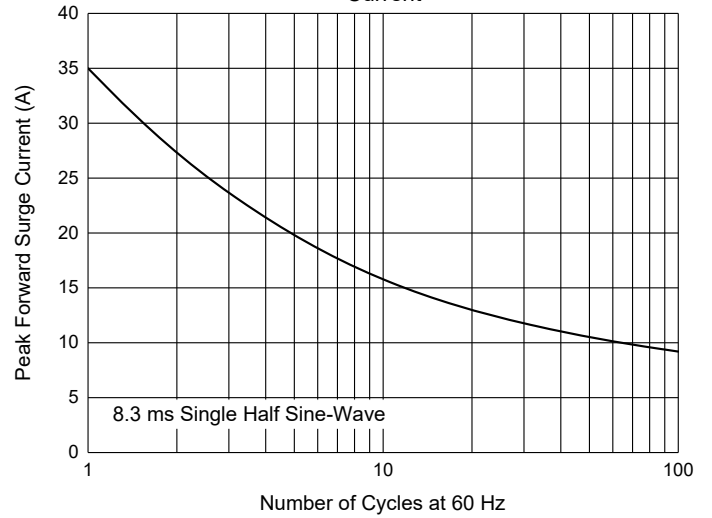

Fig. 3 - Typical Instantaneous Forward Characteristics

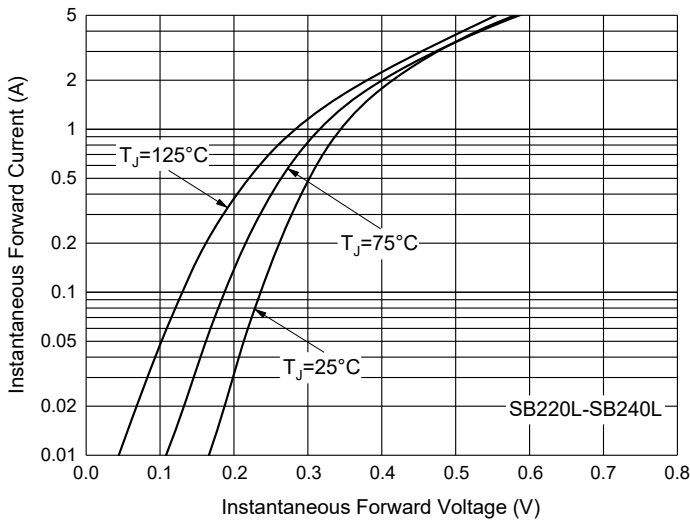

Fig. 4 - Typical Instantaneous Forward Characteristics

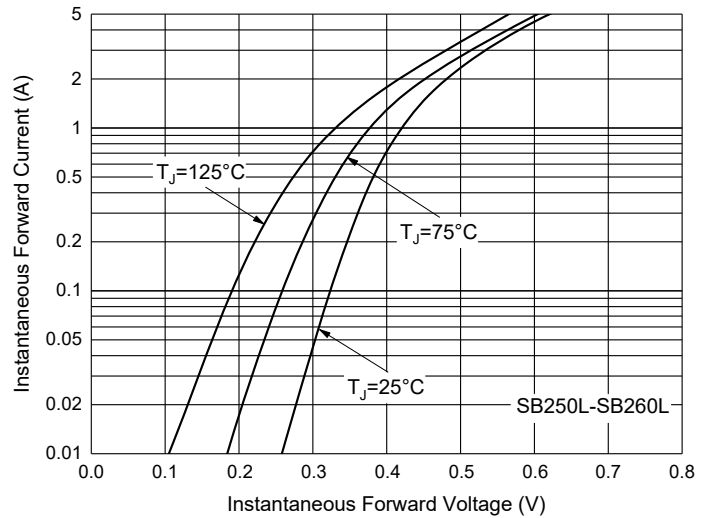

Fig. 5 - Typical Instantaneous Forward Characteristics

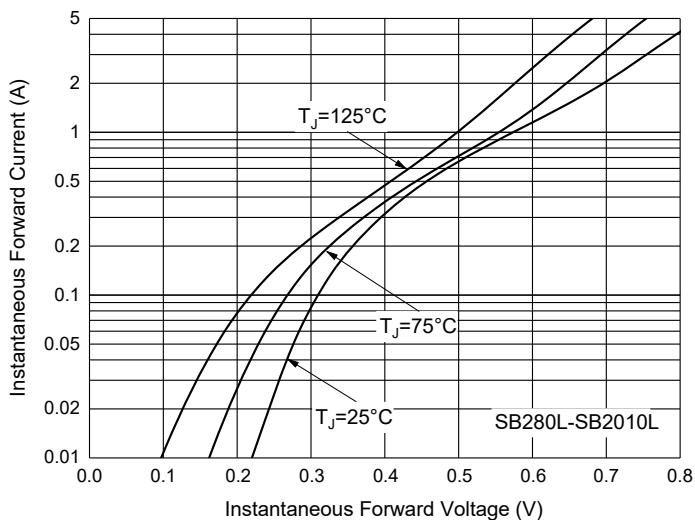
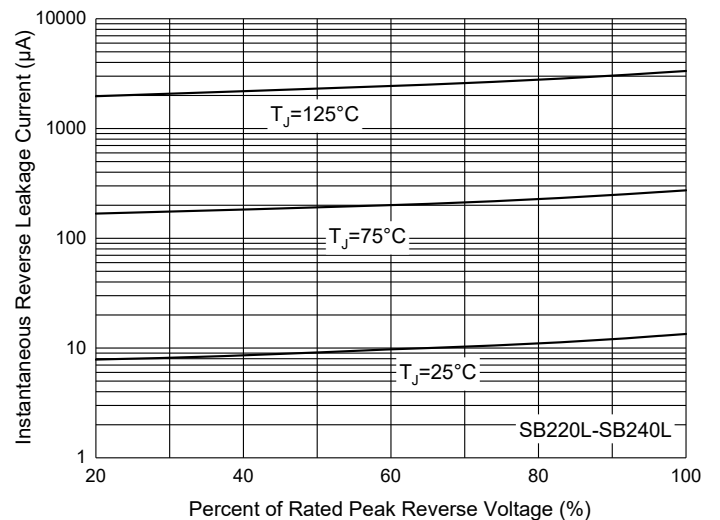

Fig. 6 - Typical Reverse Leakage Characteristics



Curve Characteristics

Fig. 7 - Typical Reverse Leakage Characteristics

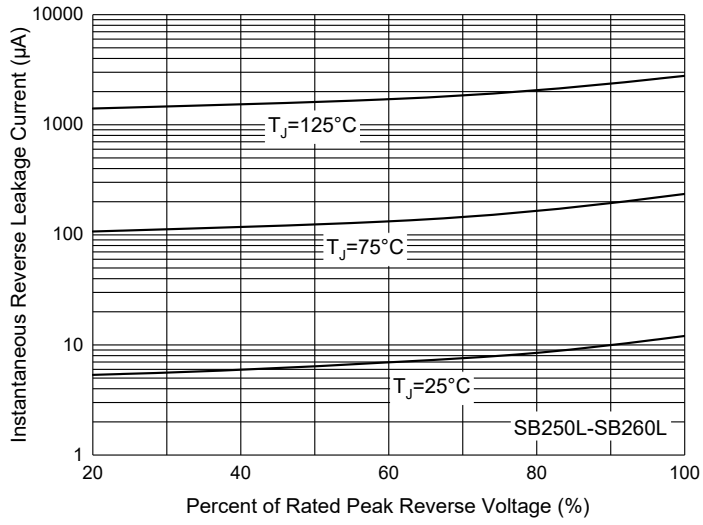
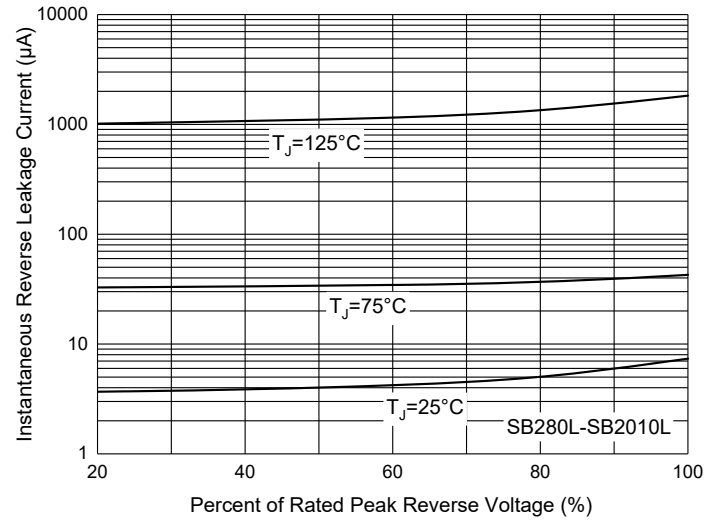

Fig. 8 - Typical Reverse Leakage Characteristics



Ordering Information

Device	Packing
(Part Number)-TP	Tape&Reel: 4Kpcs/Reel
(Part Number)-AP	Ammo Packing: 3Kpcs/Ammo Box
(Part Number)-BP	Bulk:500pcs/Box,25Kpcs/Carton

Note : Adding "-HF" Suffix For Halogen Free, eg. Part Number-TP-HF

IMPORTANT NOTICE

Micro Commercial Components Corp. reserves the right to make changes without further notice to any product herein to make corrections, modifications, enhancements, improvements, or other changes. **Micro Commercial Components Corp.** does not assume any liability arising out of the application or use of any product described herein; neither does it convey any license under its patent rights, nor the rights of others. The user of products in such applications shall assume all risks of such use and will agree to hold **Micro Commercial Components Corp.** and all the companies whose products are represented on our website, harmless against all damages. **Micro Commercial Components Corp.** products are sold subject to the general terms and conditions of commercial sale, as published at <https://www.mccsemi.com/Home/TermsAndConditions>.

LIFE SUPPORT

MCC's products are not authorized for use as critical components in life support devices or systems without the express written approval of Micro Commercial Components Corporation.

CUSTOMER AWARENESS

Counterfeiting of semiconductor parts is a growing problem in the industry. Micro Commercial Components (MCC) is taking strong measures to protect ourselves and our customers from the proliferation of counterfeit parts. MCC strongly encourages customers to purchase MCC parts either directly from MCC or from Authorized MCC Distributors who are listed by country on our web page cited below. Products customers buy either from MCC directly or from Authorized MCC Distributors are genuine parts, have full traceability, meet MCC's quality standards for handling and storage. **MCC will not provide any warranty coverage or other assistance for parts bought from Unauthorized Sources.** MCC is committed to combat this global problem and encourage our customers to do their part in stopping this practice by buying direct or from authorized distributors.