

2500W Bi-Directional Isolated DC-DC Converters

<https://product.tdk.com/en/power/eza>
www.emea.tdk-lambda.com/eza

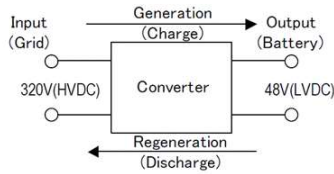

Designed for energy storage systems with rechargeable batteries, this 2500W digitally controlled, compact 1U power supply can automatically change conversion direction from high voltage dc sources, powered by solar or wind, to 48Vdc batteries and vice versa. Other applications include lithium-ion battery testing as well as the utilization of regenerated energy from robots, cranes, autonomous ground vehicles and elevators.

Features	Benefits
• 1U rackmount	• Utilizes Less Rack Space
• Seamless Transition Between Charge and Discharge	• No Interruption in Power
• > 92% Efficient	• Minimizes Losses and Heat in the System
• RS-485 Communications & Control	• Remote Programming and Monitoring Capabilities
• Input to Output Isolation	• Lower Electrical Noise

Model Selector					
Model	Low Voltage DC (Battery Side) Voltage (V)	High Voltage DC (Grid Side) Voltage (V)	Low Voltage DC (Battery Side) Current (A)	High Voltage DC (Grid Side) Current (A)	Maximum Power (W)
EZA2500-32048	36 - 60VDC (48V Nominal)	300 - 380VDC (320V Nominal)	±52A	±7.8A	±2,496W
EZA2500W-32048	36 - 65VDC (48V Nominal)	260 - 400VDC (320V Nominal)	±52A	±7.8A	±2,496W

EZA2500-32048 Options	
Suffix	Description
EZA2500-32048CO	Two sided pcb coating
EZA2500-32048FC	Two sided pcb coating -10 to +50°C temperature range Long life, dust proof fan

Specifications		
Model	EZA2500	
Input	Low Voltage DC (Battery Side)	High Voltage DC (Grid Side)
Input / Output Voltage range	Vdc	See model selector
Input / Output Current	A	See model selector
Inrush Current (Typical)	5.5A	3.6A
Pre-charge Voltage (Required)	Vdc	EZA2500: >300V EZA2500W: >260V if LVDC is <58V >280V if LVDC is >58V)
Efficiency	%	92
Conducted & Radiated EMI	-	EN55011-A, EN55032-A Conducted and radiated
Safety Agency Certifications	-	IEC/EN/UL/CSA/EN60950-1, EC/EN/UL/CSA/EN62368-1, CE Mark (LVD, EMC and RoHS)

Immunity			
Test	Standard	Test Level	Criteria
ESD	EN61000-4-2	4kV contact, 8kV discharge	A
Radiated Susceptibility	EN61000-4-3	3V/m	A
Electrical Fast Transient Burst	EN61000-4-4	2kV	A
Surge	EN61000-4-5	Common 2kV, Normal 1kV	A
Conducted Susceptibility	EN61000-4-6	3V	A
Magnetic fields	EN61000-4-8	-	A

Specifications			
Model		EZA2500	
Output		Low Voltage DC (Battery Side)	High Voltage DC (Grid Side)
Output Voltage Adjustment		See model selector	
Line Regulation	V	0.24	1.52
Load Regulation	V	0.48	3.04
Temperature Regulation (Maximum)	V	0.3	1.9
Ripple & Noise	V	<0.48	<3.2
Sink Current (When applied V > output set V)	mA	300	50
Overcurrent Protection (Manual reset)	A	60	9.5
Overpower Protection (Constant Power)	W	2600	2600
Under & Overvoltage Protection (1)	V	32 - 68 (EZA2500W 32 - 70)	260 - 425 (EZA2500W 240 - 410)
Overtemperature Protection	-	Alarm signal is given	
Remote On/Off & Reset (1)	-	Yes	
Front panel Indicators and Settings	-	Operating mode (Generating, Regenerating & Alarm), Alarm clear & RS-485 address selection	
RS-485 Functions			
Voltage Setting Accuracy	-	< ±0.6V	< ±4V
Current Setting Accuracy	-	< ±0.8A	< ±0.125A
Voltage Setting Resolution	-	< 60mV	< 0.4V
Current Setting Resolution	-	< 50mA	< 8mA
Voltage Reading Accuracy	-	< ±0.6V	< ±4V
Current Reading Accuracy	-	< ±0.8A	< ±0.125A
Voltage Reading Resolution	-	< 60mV	< 0.4V
Current Reading Resolution	-	< 50mA	< 8mA
RS-485 Baud Rate	-	19.2kbps / 33.6kbps / 57.6kbps (Set by DIP Switch)	
RS-485 Maximum Connection	-	14	
Environmental			
Operating Temperature	°C	-10° to +40°C (EZA2500W -10° to +50°C), see derating curve section	
Storage Temperature	°C	-20° to +85°C	
Operating Humidity (Non Condensing)	%RH	30 - 95%RH (Operating & Storage)	
Storage Humidity (Non Condensing)	%RH	10 - 95%RH (Operating & Storage)	
Cooling	-	Internal fans	
Altitude	m	2,000m	
Withstand Voltage (For 1 minute)	VAC	Input (HVDC) to Output (LVDC) 3kVAC, Input to Ground 2kVAC, Output to Ground 500VAC	
Isolation Resistance	MΩ	>100MΩ at 25°C & 70%RH, Output to Ground 500VDC	
Vibration (Non-operating)	-	10-500Hz (1 min sweep), 10.2m/s ² constant for 1 hour in each direction: X, Y & Z axis	
Shock	-	196.1m/s ² maximum	
Other			
Weight (Typ)	g	8000	
Size (WxHxD)	mm	422.8 x 43.6 x 400	
Size (WxHxD)	Inches	16.65 x 1.72 x 15.75	
Warranty	yrs	5	

Notes

See website for detailed specifications, test methods and installation manual

(1) Can be set via RS-485

Block Diagram

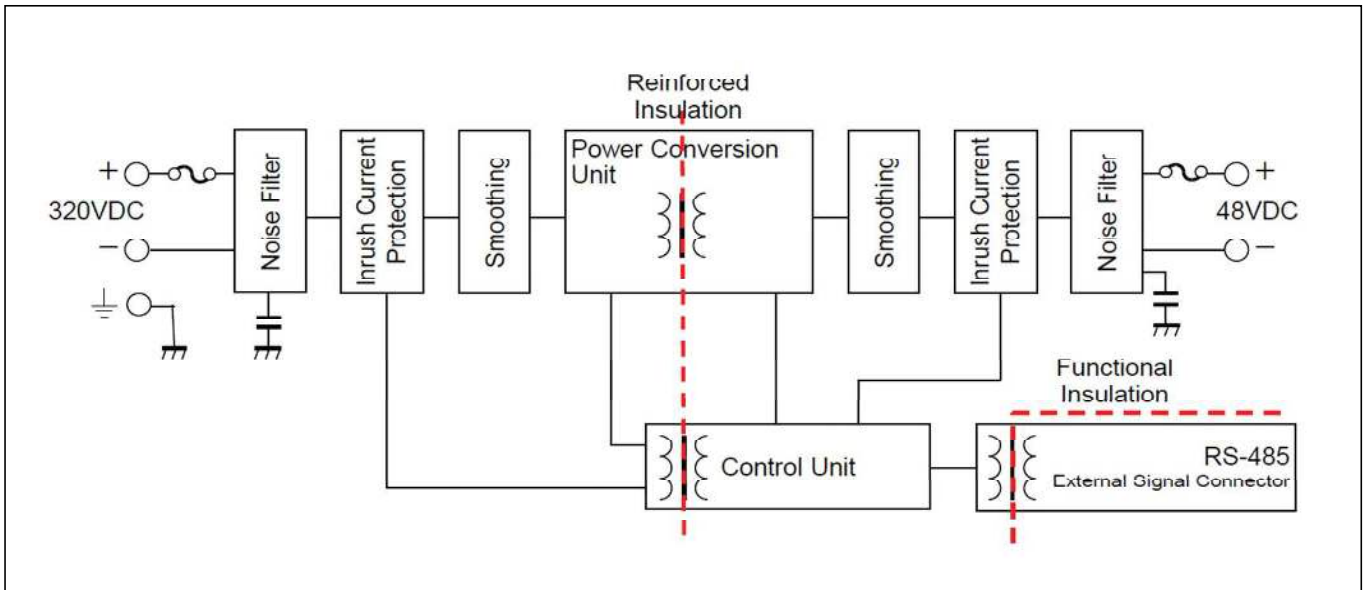

Derating Curves EZA2500-32048

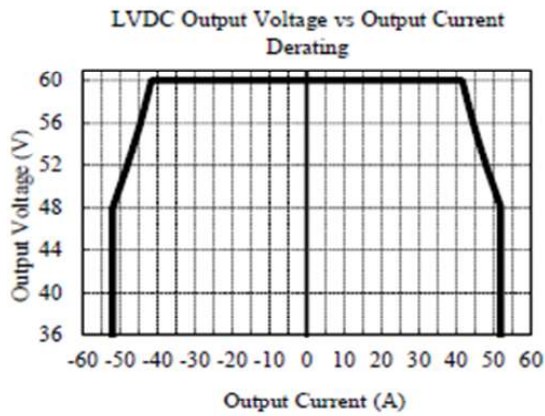

Fig. 1

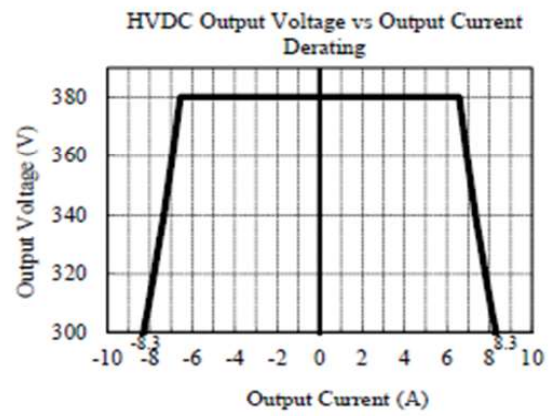

Fig. 2

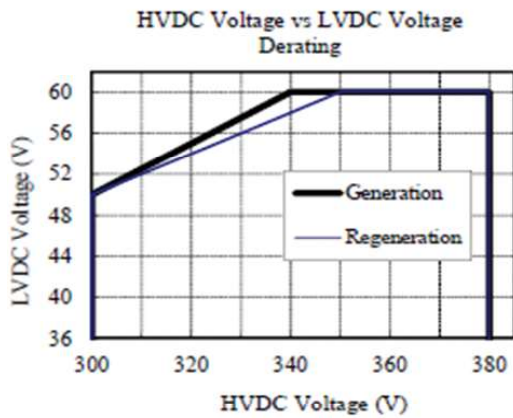

Fig. 3

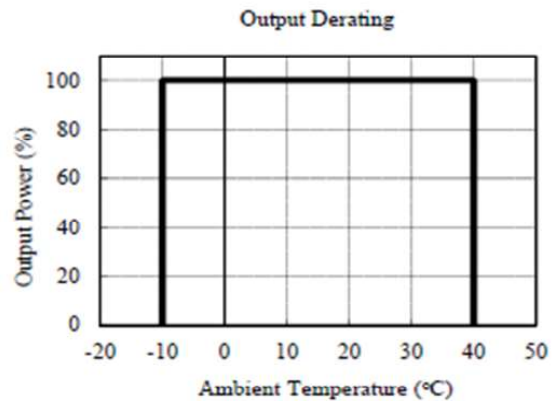

Fig. 4

Derating Curves EZA2500W-32048

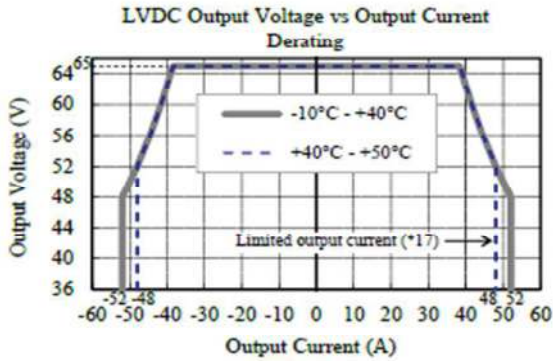

Fig. 1

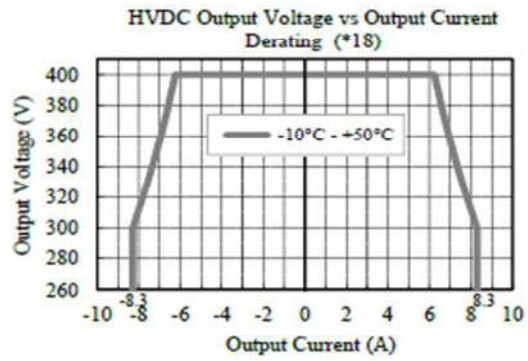

Fig. 2

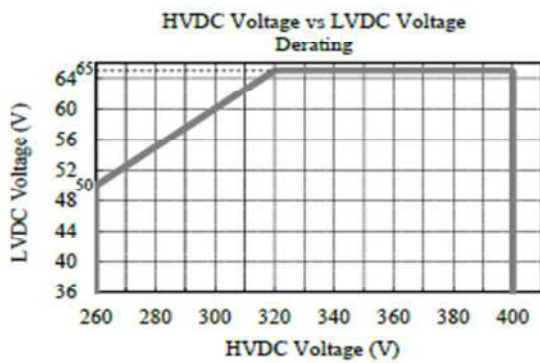

Fig. 3

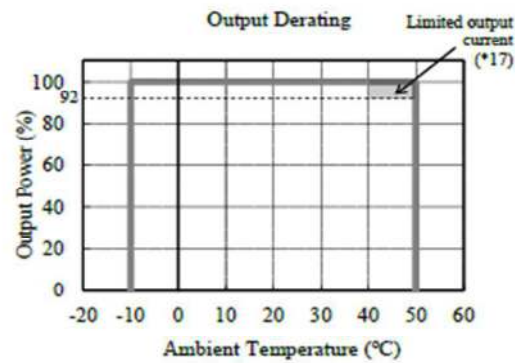

Fig. 4

Please read instruction manual Carefully, before using.

=Note=

*17. $T_a > 40^\circ\text{C}$: Maximum LVDC current is limited to 48A, Therefore, Maximum output power depends on voltage conditions.

*18. When regeneration mode, Maximum LVDC current is limited to 56A.

Outline Drawing

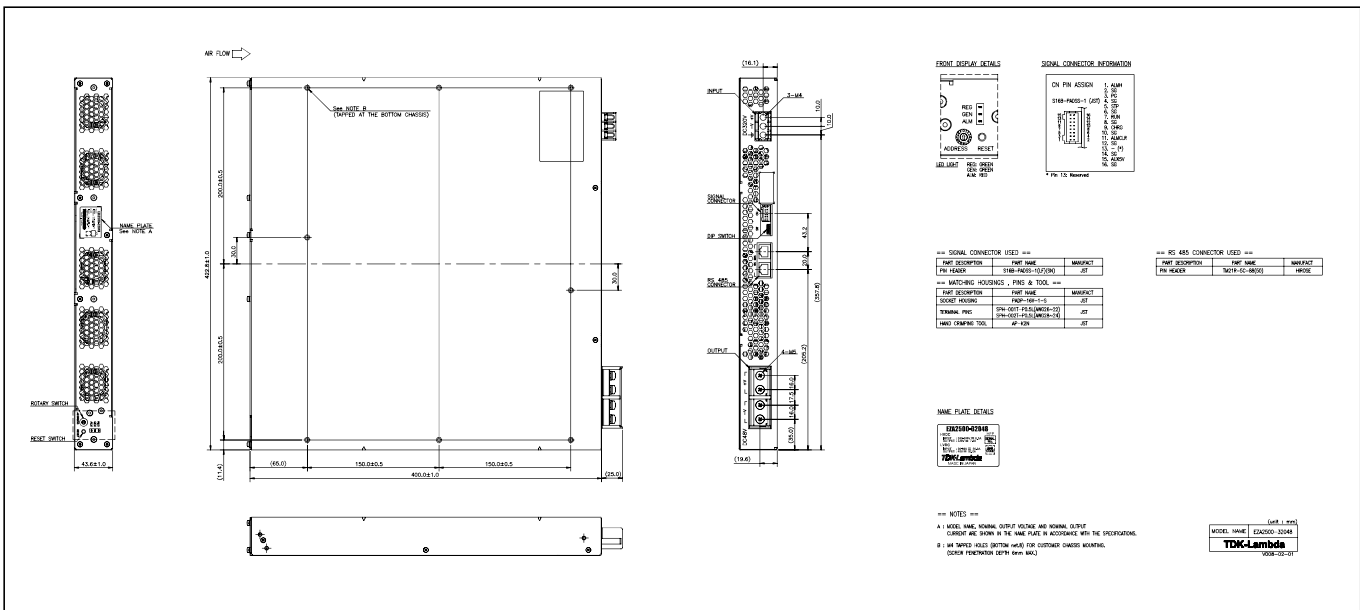



TDK-Lambda France SAS

Tel: +33 1 60 12 71 65
france@fr.tdk-lambda.com
www.emea.lambda.tdk.com/fr



Italy Sales Office

Tel: +39 02 61 29 38 63
info.italia@it.tdk-lambda.com
www.emea.lambda.tdk.com/it



Netherlands

info@nl.tdk-lambda.com
www.emea.lambda.tdk.com/nl



TDK-Lambda Germany GmbH

Tel: +49 7841 666 0
info.germany@de.tdk-lambda.com
www.emea.lambda.tdk.com/de



Austria Sales Office

Tel: +43 2256 655 84
info@at.tdk-lambda.com
www.emea.lambda.tdk.com/at



Switzerland Sales Office

Tel: +41 44 850 53 53
info@ch.tdk-lambda.com
www.emea.lambda.tdk.com/ch



Nordic Sales Office

Tel: +45 8853 8086
info@dk.tdk-lambda.com
www.emea.lambda.tdk.com/dk



TDK-Lambda UK Ltd.

Tel: +44 (0) 12 71 85 66 66
powersolutions@uk.tdk-lambda.com
www.emea.lambda.tdk.com/uk



TDK-Lambda Ltd.

Tel: +9 723 902 4333
info@tdk-lambda.co.il
www.emea.lambda.tdk.com/il



C.I.S.

Commercial Support:

Tel: +7 (495) 665 2627

Technical Support:

Tel: +7 (812) 658 0463
info@tdk-lambda.ru
www.emea.lambda.tdk.com/ru



TDK-Lambda Americas

Tel: +1 800-LAMBDA-4 or 1-800-526-2324
powersolutions@us.tdk-lambda.com
www.us.lambda.tdk.com



TDK Electronics do Brasil Ltda

Tel: +55 11 3289-9599
sales.br@tdk-electronics.tdk.com
www.tdk-electronics.tdk.com/en



TDK-Lambda Corporation

Tel: +81-3-6778-1113
www.jp.lambda.tdk.com



TDK-Lambda (China) Electronics Co. Ltd.

Tel: +86 21 6485-0777
powersolutions@cn.tdk-lambda.com
www.lambda.tdk.com.cn



TDK-Lambda Singapore Pte Ltd.

Tel: +65 6251 7211
tfs.mkt@sg.tdk-lambda.com
www.sg.lambda.tdk.com



TDK India Private Limited, Power Supply Division

Tel: +91 80 4039-0660
mathew.philip@in.tdk-lambda.com
www.www.lambda.tdk.com

