

REVISIONS					
P	LTR	DESCRIPTION	DATE	DWN	APVD
C	I	REVISED PER ECO-11-005294	30APR2011	RK	HMR
D	D	REVISED PER ECO-13-019168	05DEC2013	DR	RB

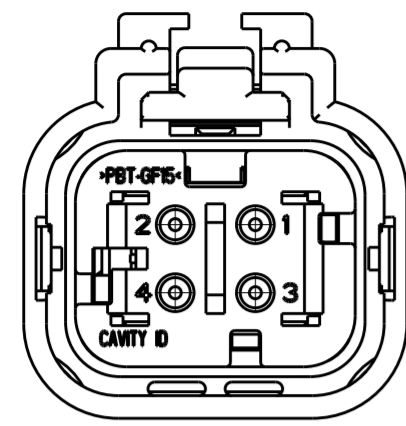

776524-2
SCALE 2:1

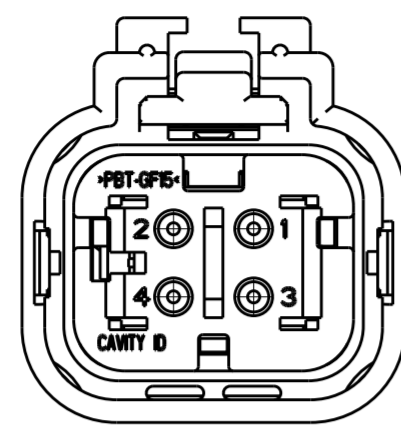

776524-3
SCALE 2:1

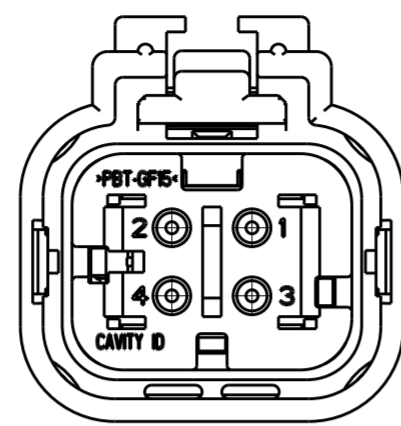

776524-4
SCALE 2:1

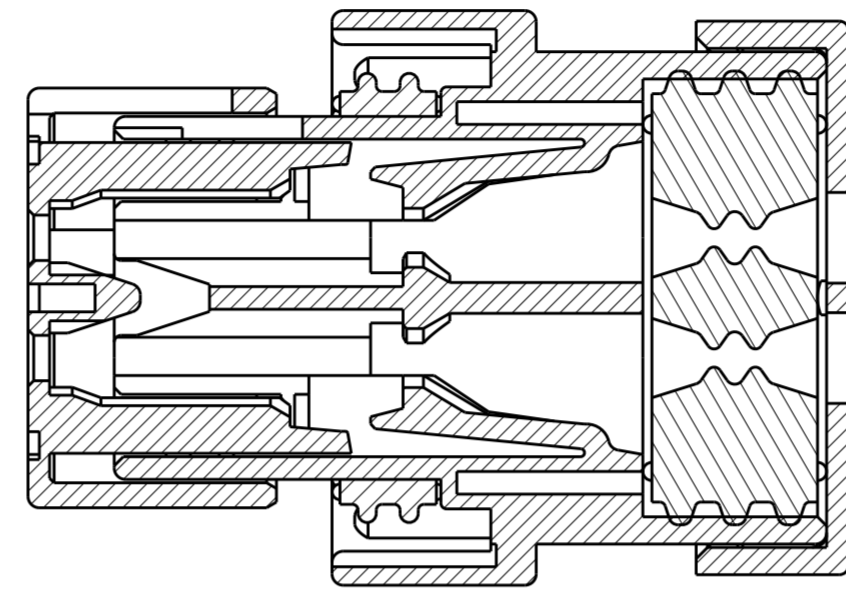

SECTION B-B

- 1 MATERIAL: 15% GLASS FILLED THERMOPLASTIC
COLOR: BLACK
- 2 MATERIAL: 15% GLASS FILLED THERMOPLASTIC
COLOR: (SEE TABLE)
- 3 MATERIAL: SILICONE
COLOR: RUST
- 4 MATERIAL: 15% GLASS FILLED THERMOPLASTIC
COLOR: RED
- 5. RECOMMENDED WIRE DIAMETER RANGE IS 1.30 TO 2.54mm
- 6 MATERIAL: SILICONE
COLOR: TAN

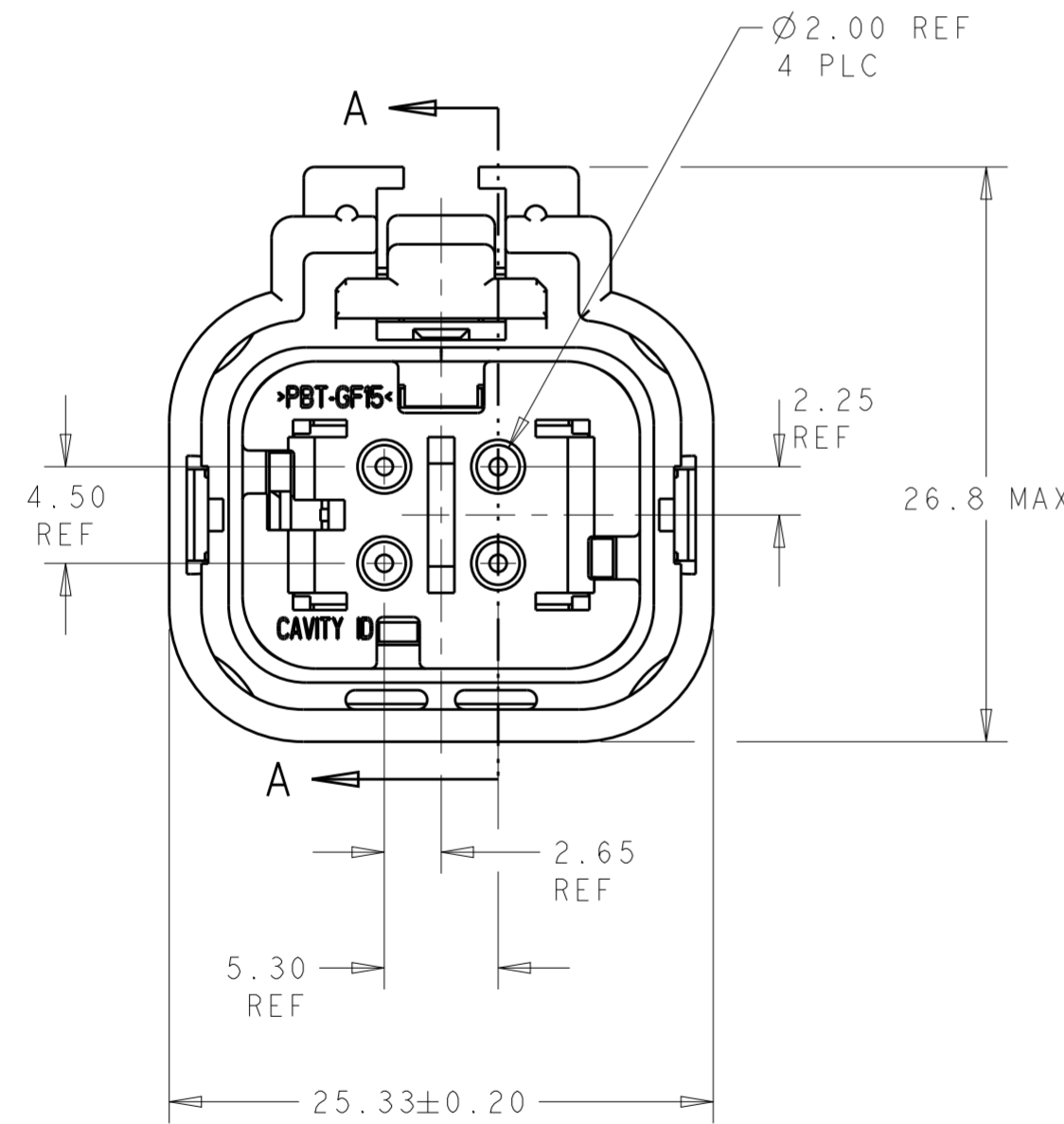

776524-1 SHOWN

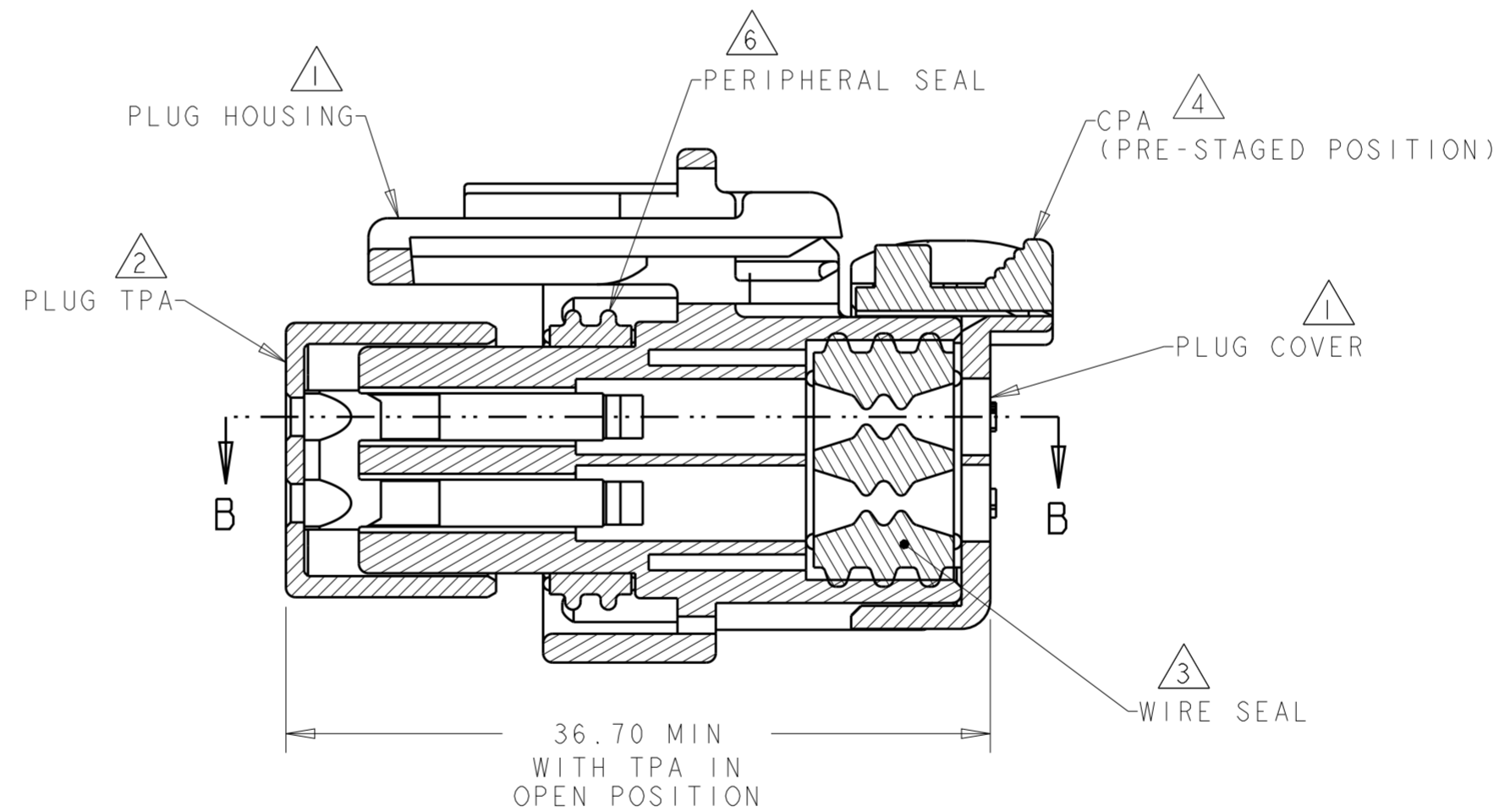

SECTION A-A

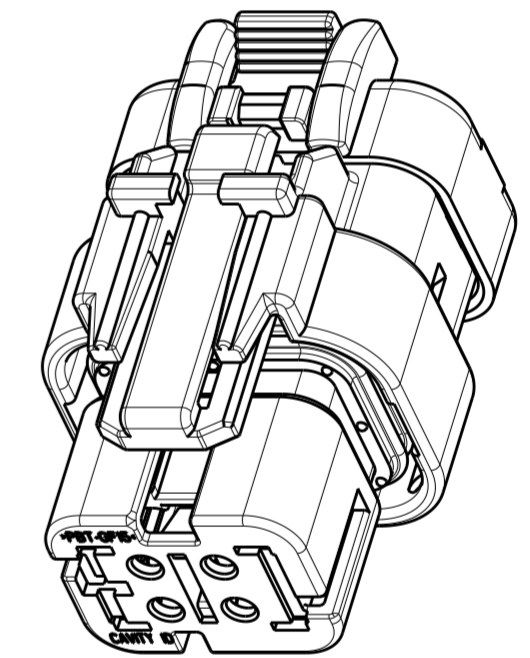

SCALE 2:1

GREEN	776524-4
YELLOW	776524-3
GRAY	776524-2
RED	776524-1
TPA COLOR	PART NUMBER

THIS DRAWING IS A CONTROLLED DOCUMENT.		DWN W. HOELSCHER 04SEP2003	TE Connectivity	
DIMENSIONS: mm		CHK J. PATTERSON 04SEP2003		
TOLERANCES UNLESS OTHERWISE SPECIFIED:		APVD D. KLEIN 04SEP2003	NAME PLUG ASSEMBLY, 4 POSITION, 2 ROW, AMPSEAL 16 CONNECTOR REDUCED DIA WIRE SEAL	
0 PLC ±		PRODUCT SPEC 108-2184	SIZE CAGE CODE DRAWING NO RESTRICTED TO	
1 PLC ±		APPLICATION SPEC 114-13065	A20779C-776524	
2 PLC ±		WEIGHT 12.5±1g	SCALE 3:1 SHEET 1 OF 1 REV D	
3 PLC ±		Customer Drawing		
4 PLC ±				
ANGLES ±				
FINISH -				