

# TLV2432-Q1, TLV2432A-Q1, TLV2434-Q1, TLV2434A-Q1 Advanced LinCMOS™ RAIL-TO-RAIL OUTPUT WIDE-INPUT-VOLTAGE OPERATIONAL AMPLIFIERS

SGLS182B – SEPTEMBER 2003 – REVISED NOVEMBER 2010

- Qualified for Automotive Applications
- ESD Protection Exceeds 2000 V Per MIL-STD-883, Method 3015; Exceeds 200 V Using Machine Model (C = 200 pF, R = 0)
- Output Swing Includes Both Supply Rails
- Extended Common-Mode Input Voltage Range . . . 0 V to 4.5 V (Min) with 5-V Single Supply
- No Phase Inversion
- Low Noise . . . 18 nV/√Hz Typ at f = 1 kHz
- Low Input Offset Voltage  
950 μV Max at T<sub>A</sub> = 25°C (TLV243xA)
- Low Input Bias Current . . . 1 pA Typ
- Very Low Supply Current . . . 125 μA Per Channel Max
- 600-Ω Output Drive
- Macromodel Included

## description

The TLV243x and TLV243xA are low-voltage operational amplifier from Texas Instruments. The common-mode input voltage range for each device is extended over the typical CMOS amplifiers making them suitable for a wide range of applications. In addition, these devices do not phase invert when the common-mode input is driven to the supply rails. This satisfies most design requirements without paying a premium for rail-to-rail input performance. They also exhibit rail-to-rail output performance for increased dynamic range in single- or split-supply applications. This family is fully characterized at 3-V and 5-V supplies and is optimized for low-voltage operation. The TLV243x only requires 100 μA (typ) of supply current per channel, making it ideal for battery-powered applications. The TLV243x also has increased output drive over previous rail-to-rail operational amplifiers and can drive 600-Ω loads for telecom applications.

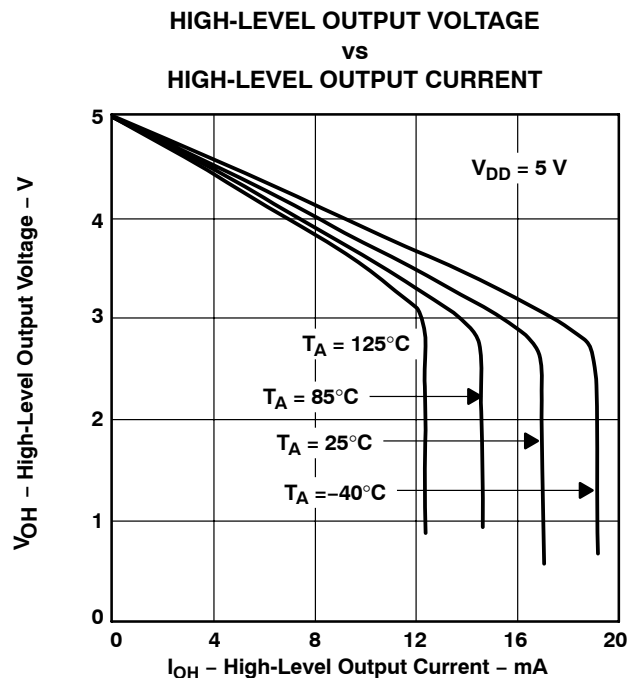

Figure 1

The other members in the TLV243x family are the high-power, TLV244x, and micro-power, TLV2422, versions.

The TLV243x, exhibiting high input impedance and low noise, is excellent for small-signal conditioning for high-impedance sources, such as piezoelectric transducers. Because of the micropower dissipation levels and low-voltage operation, these devices work well in hand-held monitoring and remote-sensing applications. In addition, the rail-to-rail output feature with single- or split-supplies makes this family a great choice when interfacing with analog-to-digital converters (ADCs). For precision applications, the TLV243xA is available and has a maximum input offset voltage of 950 μV.

If the design requires single operational amplifiers, see the TI TLV2211/21/31. This is a family of rail-to-rail output operational amplifiers in the SOT-23 package. Their small size and low power consumption, make them ideal for high density, battery-powered equipment.



Please be aware that an important notice concerning availability, standard warranty, and use in critical applications of Texas Instruments semiconductor products and disclaimers thereto appears at the end of this data sheet.

PRODUCTION DATA information is current as of publication date. Products conform to specifications per the terms of Texas Instruments standard warranty. Production processing does not necessarily include testing of all parameters.

 **TEXAS  
INSTRUMENTS**

POST OFFICE BOX 655303 • DALLAS, TEXAS 75265

Copyright © 2008 Texas Instruments Incorporated

**TLV2432-Q1, TLV2432A-Q1, TLV2434-Q1, TLV2434A-Q1**  
**Advanced LinCMOS™ RAIL-TO-RAIL OUTPUT**  
**WIDE-INPUT-VOLTAGE OPERATIONAL AMPLIFIERS**

SGLS182B – SEPTEMBER 2003 – REVISED NOVEMBER 2010

**ORDERING INFORMATION†**

| $T_A$          | $V_{IOmax}$<br>AT 25°C | PACKAGE‡   |               | ORDERABLE<br>PART NUMBER | TOP-SIDE<br>MARKING |
|----------------|------------------------|------------|---------------|--------------------------|---------------------|
| -40°C to 125°C | 950 $\mu$ V            | SOIC (D)   | Tape and reel | TLV2432AQDRQ1            | 2432AQ              |
|                |                        | TSSOP (PW) | Tape and reel | TLV2432AQPWRQ1§          |                     |
|                | 2.5 mV                 | SOIC (D)   | Tape and reel | TLV2432QDRQ1             | 2432Q1              |
|                |                        | TSSOP (PW) | Tape and reel | TLV2432QPWRQ1§           |                     |
| -40°C to 125°C | 950 $\mu$ V            | SOIC (D)   | Tape and reel | TLV2434AQDRQ1            | 2434AQ              |
|                |                        | TSSOP (PW) | Tape and reel | TLV2434AQPWRQ1§          |                     |
|                | 2.5 mV                 | SOIC (D)   | Tape and reel | TLV2434QDRQ1§            |                     |
|                |                        | TSSOP (PW) | Tape and reel | TLV2434QPWRQ1§           |                     |

† For the most current package and ordering information, see the Package Option Addendum at the end of this document, or see the TI web site at <http://www.ti.com>.

‡ Package drawings, thermal data, and symbolization are available at <http://www.ti.com/packaging>.

§ Product Preview.

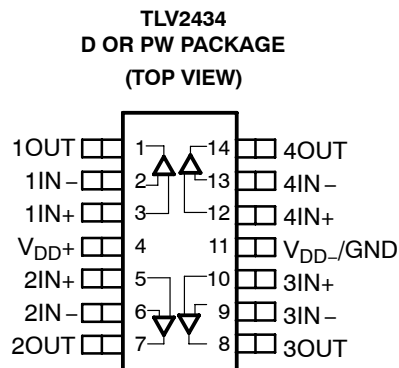
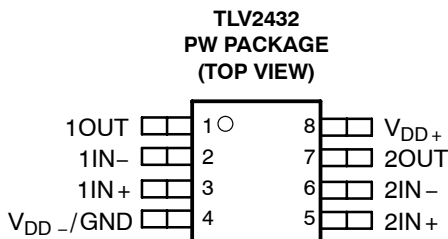
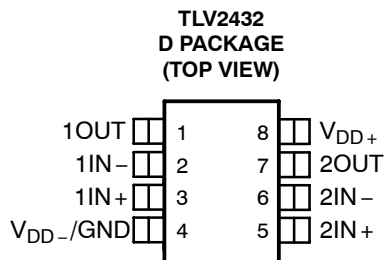

**TLV2432-Q1, TLV2432A-Q1, TLV2434-Q1, TLV2434A-Q1**  
**Advanced LincMOS™ RAIL-TO-RAIL OUTPUT**  
**WIDE-INPUT-VOLTAGE OPERATIONAL AMPLIFIERS**

SLS182B - SEPTEMBER 2003 - REVISED NOVEMBER 2010

equivalent schematic (each amplifier)

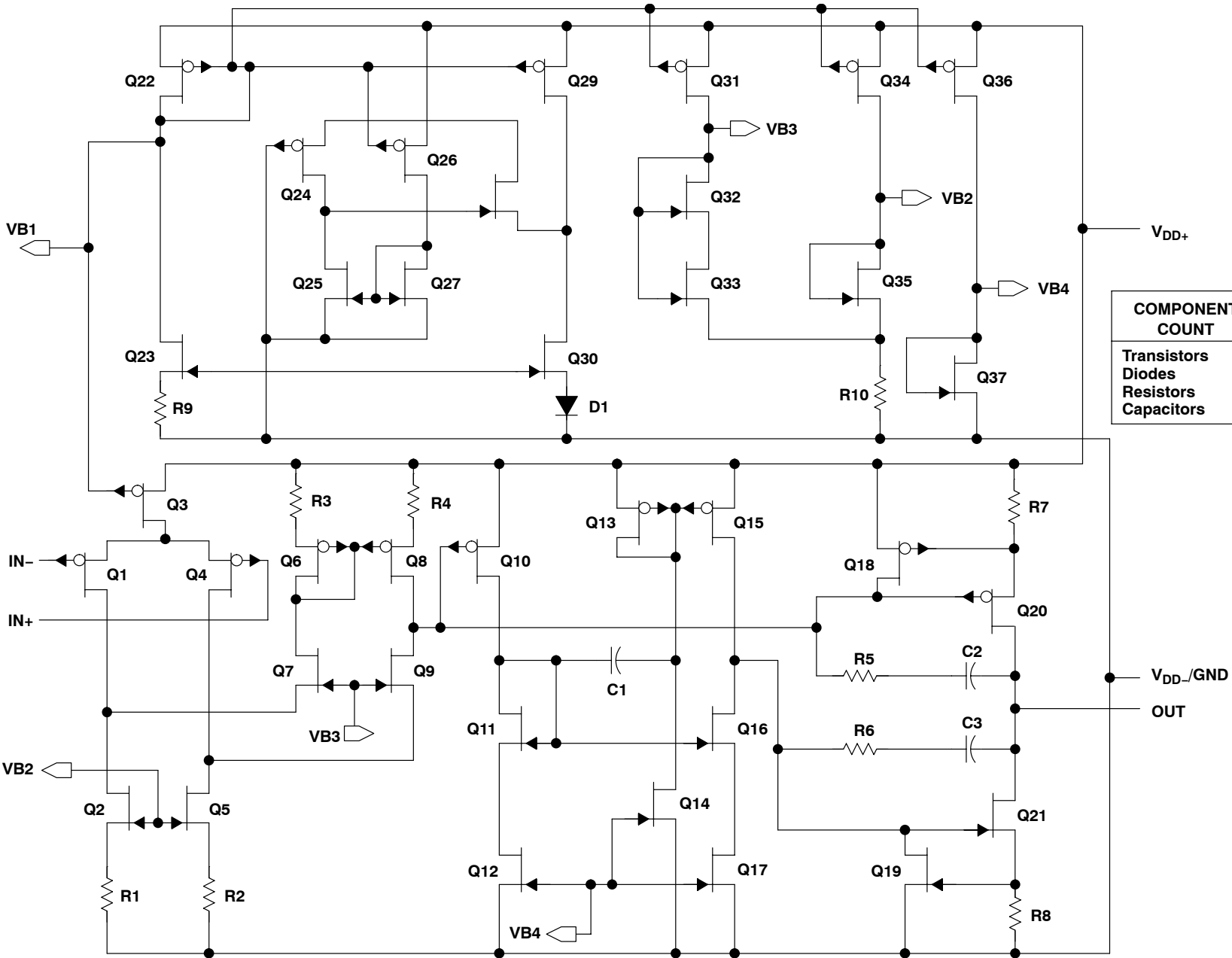

| COMPONENT COUNT |    |
|-----------------|----|
| Transistors     | 69 |
| Diodes          | 5  |
| Resistors       | 26 |
| Capacitors      | 6  |

**TLV2432-Q1, TLV2432A-Q1, TLV2434-Q1, TLV2434A-Q1**  
**Advanced LinCMOS™ RAIL-TO-RAIL OUTPUT**  
**WIDE-INPUT-VOLTAGE OPERATIONAL AMPLIFIERS**

SGLS182B – SEPTEMBER 2003 – REVISED NOVEMBER 2010

**absolute maximum ratings over operating free-air temperature range (unless otherwise noted)†**

|   |                              |
|---|------------------------------|
| Supply voltage, $V_{DD}$ (see Note 1)                             | 12 V                         |
| Differential input voltage, $V_{ID}$ (see Note 2)                 | $\pm V_{DD}$                 |
| Input current, $I_I$ (each input)                                 | $\pm 5$ mA                   |
| Output current, $I_O$   | $\pm 50$ mA                  |
| Total current into $V_{DD+}$                                      | $\pm 50$ mA                  |
| Total current out of $V_{DD-}$                                    | $\pm 50$ mA                  |
| Duration of short-circuit current at (or below) 25°C (see Note 3) | unlimited                    |
| Continuous total dissipation                                      | See Dissipation Rating Table |
| Operating free-air temperature range, $T_A$ : Q suffix            | -40°C to 125°C               |
| Storage temperature range, $T_{stg}$                              | -65°C to 150°C               |
| Lead temperature 1,6 mm (1/16 inch) from case for 10 seconds      | 260°C                        |

† Stresses beyond those listed under “absolute maximum ratings” may cause permanent damage to the device. These are stress ratings only, and functional operation of the device at these or any other conditions beyond those indicated under “recommended operating conditions” is not implied. Exposure to absolute-maximum-rated conditions for extended periods may affect device reliability.

- NOTES: 1. All voltage values, except differential voltages, are with respect to the midpoint between  $V_{DD+}$  and  $V_{DD-}$ .  
 2. Differential voltages are at  $IN+$  with respect to  $IN-$ . Excessive current flows if input is brought below  $V_{DD-} - 0.3$  V.  
 3. The output may be shorted to either supply. Temperature and/or supply voltages must be limited to ensure that the maximum dissipation rating is not exceeded.

**DISSIPATION RATING TABLE**

| PACKAGE | $T_A \leq 25^\circ\text{C}$<br>POWER RATING | DERATING FACTOR<br>ABOVE $T_A = 25^\circ\text{C}$ | $T_A = 70^\circ\text{C}$<br>POWER RATING | $T_A = 85^\circ\text{C}$<br>POWER RATING | $T_A = 125^\circ\text{C}$<br>POWER RATING |
|---------|---|---|--|--|---|
| D (8)   | 725 mW                                      | 5.8 mW/°C   | 464 mW                                   | 377 mW                                   | 145 mW                                    |
| D (14)  | 1022 mW                                     | 7.6 mW/°C   | 900 mW                                   | 777 mW                                   | 450 mW                                    |
| PW (8)  | 525 mW                                      | 4.2 mW/°C   | 336 mW                                   | 273 mW                                   | 105 mW                                    |
| PW (14) | 720 mW                                      | 5.6 mW/°C   | 634 mW                                   | 547 mW                                   | 317 mW                                    |

**recommended operating conditions**

|                                       | MIN       | MAX             | UNIT |
|---------------------------------------|-----------|-----------------|------|
| Supply voltage, $V_{DD}$              | 2.7       | 10              | V    |
| Input voltage range, $V_I$            | $V_{DD-}$ | $V_{DD+} - 0.8$ | V    |
| Common-mode input voltage, $V_{IC}$   | $V_{DD-}$ | $V_{DD+} - 0.8$ | V    |
| Operating free-air temperature, $T_A$ | -40       | 125             | °C   |



**TLV2432-Q1, TLV2432A-Q1, TLV2434-Q1, TLV2434A-Q1**  
**Advanced LinCMOS™ RAIL-TO-RAIL OUTPUT**  
**WIDE-INPUT-VOLTAGE OPERATIONAL AMPLIFIERS**

SGLS182B – SEPTEMBER 2003 – REVISED NOVEMBER 2010

**electrical characteristics at specified free-air temperature,  $V_{DD} = 3\text{ V}$  (unless otherwise noted)**

| PARAMETER  | TEST CONDITIONS   |                                   | $T_A^\dagger$ | TLV243x-Q1 |               |                              | UNIT |
|--|---|-----------------------------------|---------------|------------|---------------|------------------------------|------|
|  |   |                                   |               | MIN        | TYP           | MAX                          |      |
| $V_{IO}$ Input offset voltage  | $V_{IC} = 0,$<br>$V_O = 0,$<br>$V_{DD} \pm = \pm 1.5\text{ V},$<br>$R_S = 50\ \Omega$ | TLV243x                           | 25°C          | 300        | 2000          | $\mu\text{V}$                |      |
|  |   |                                   | Full range    | 2500       |               |                              |      |
|  |   | TLV243xA                          | 25°C          | 300        | 950           |                              |      |
|  |   |                                   | Full range    | 2000       |               |                              |      |
| $\alpha_{V_{IO}}$ Temperature coefficient of input offset voltage          | $V_{IC} = 0,$<br>$V_O = 0,$<br>$V_{DD} \pm = \pm 1.5\text{ V},$<br>$R_S = 50\ \Omega$ |                                   | 25°C to 70°C  | 2          |               | $\mu\text{V}/^\circ\text{C}$ |      |
| Input offset voltage long-term drift (see Note 4)                          |   |                                   | 25°C          | 0.003      |               | $\mu\text{V}/\text{mo}$      |      |
| $I_{IO}$ Input offset current  |   |                                   | 25°C          | 0.5        |               | $\text{pA}$                  |      |
|  |   |                                   | Full range    | 150        |               |                              |      |
| $I_{IB}$ Input bias current  |   |                                   | 25°C          | 1          |               | $\text{pA}$                  |      |
|  |   |                                   | Full range    | 300        |               |                              |      |
| $V_{ICR}$ Common-mode input voltage range                                  | $ V_{IO}  \leq 5\text{ mV},$  | $R_S = 50\ \Omega$                | 25°C          | 0 to 2.5   | -0.25 to 2.75 | V                            |      |
|  |   |                                   | Full range    | 0 to 2.2   |               |                              |      |
| $V_{OH}$ High-level output voltage   | $I_{OH} = -100\ \mu\text{A}$  |                                   | 25°C          | 2.98       |               | V                            |      |
|  |   |                                   | 25°C          | 2.5        |               |                              |      |
|  |   |                                   | Full range    | 2.25       |               |                              |      |
| $V_{OL}$ Low-level output voltage  | $V_{IC} = 1.5\text{ V},$  | $I_{OL} = 100\ \mu\text{A}$       | 25°C          | 0.02       |               | V                            |      |
|  |   |                                   | 25°C          | 0.83       |               |                              |      |
|  | $V_{IC} = 1.5\text{ V},$  | $I_{OL} = 3\text{ mA}$            | Full range    | 1          |               |                              |      |
| $A_{VD}$ Large-signal differential voltage amplification                   | $V_{IC} = 2.5\text{ V},$<br>$V_O = 1\text{ V to }2\text{ V}$                          | $R_L = 2\text{ k}\Omega^\ddagger$ | 25°C          | 1.5        | 2.5           | V/mV                         |      |
|  |   |                                   | Full range    | 0.5        |               |                              |      |
|  |   | $R_L = 1\text{ M}\Omega^\ddagger$ | 25°C          | 750        |               |                              |      |
| $r_{i(d)}$ Differential input resistance                                   |   |                                   | 25°C          | 1000       |               | $\text{G}\Omega$             |      |
| $r_{i(c)}$ Common-mode input resistance                                    |   |                                   | 25°C          | 1000       |               | $\text{G}\Omega$             |      |
| $c_{i(c)}$ Common-mode input capacitance                                   | $f = 10\text{ kHz}$   |                                   | 25°C          | 8          |               | $\text{pF}$                  |      |
| $z_o$ Closed-loop output impedance   | $f = 100\text{ kHz},$   | $A_V = 10$                        | 25°C          | 130        |               | $\Omega$                     |      |
| CMRR Common-mode rejection ratio   | $V_{IC} = V_{ICR\text{ MIN}},$  | $V_O = 1.5\text{ V},$             | 25°C          | 70         | 83            | dB                           |      |
|  |   |                                   | Full range    | 70         |               |                              |      |
| $k_{SVR}$ Supply-voltage rejection ratio ( $\Delta V_{DD}/\Delta V_{IO}$ ) | $V_{DD} = 2.7\text{ V to }8\text{ V},$  | $V_{IC} = V_{DD}/2,$              | 25°C          | 80         | 95            | dB                           |      |
|  |   |                                   | Full range    | 80         |               |                              |      |
| $I_{DD}$ Supply current  | $V_O = 1.5\text{ V},$   | No load                           | 25°C          | 195        | 250           | $\mu\text{A}$                |      |
|  |   |                                   | Full range    | 260        |               |                              |      |

$^\dagger$  Full range is  $-40^\circ\text{C}$  to  $125^\circ\text{C}$  for Q level part.

$^\ddagger$  Referenced to 2.5 V

NOTE 4: Typical values are based on the input offset voltage shift observed through 500 hours of operating life test at  $T_A = 150^\circ\text{C}$  extrapolated to  $T_A = 25^\circ\text{C}$  using the Arrhenius equation and assuming an activation energy of 0.96 eV.



**TLV2432-Q1, TLV2432A-Q1, TLV2434-Q1, TLV2434A-Q1**  
**Advanced LinCMOS™ RAIL-TO-RAIL OUTPUT**  
**WIDE-INPUT-VOLTAGE OPERATIONAL AMPLIFIERS**

SGLS182B – SEPTEMBER 2003 – REVISED NOVEMBER 2010

operating characteristics at specified free-air temperature,  $V_{DD} = 3\text{ V}$

| PARAMETER   | TEST CONDITIONS   | $T_A^\dagger$                                | TLV243x-Q1,<br>TLV243xA-Q1 |        |      | UNIT                   |
|---|---|--|----------------------------|--------|------|------------------------|
|   |   |  | MIN                        | TYP    | MAX  |                        |
| SR Slew rate at unity gain                              | $V_O = 1\text{ V to }2\text{ V},$<br>$C_L = 100\text{ pF}^\ddagger$   | $R_L = 2\text{ k}\Omega^\ddagger,$           | 25°C                       | 0.15   | 0.25 | V/ $\mu$ s             |
|   |   |  | Full range                 | 0.1    |      |                        |
| $V_n$ Equivalent input noise voltage                    | $f = 10\text{ Hz}$  |  | 25°C                       | 120    |      | nV/ $\sqrt{\text{Hz}}$ |
|   | $f = 1\text{ kHz}$  |  | 25°C                       | 22     |      |                        |
| $V_{N(PP)}$ Peak-to-peak equivalent input noise voltage | $f = 0.1\text{ Hz to }1\text{ Hz}$  |  | 25°C                       | 2.7    |      | $\mu$ V                |
|   | $f = 0.1\text{ Hz to }10\text{ Hz}$   |  | 25°C                       | 4      |      |                        |
| $I_n$ Equivalent input noise current                    |   |  | 25°C                       | 0.6    |      | fA/ $\sqrt{\text{Hz}}$ |
| THD + N Total harmonic distortion plus noise            | $V_O = 0.5\text{ V to }2.5\text{ V},$<br>$f = 1\text{ kHz},$<br>$R_L = 2\text{ k}\Omega^\ddagger$             | $A_V = 1$                                    | 25°C                       | 0.065% |      |                        |
|   |   | $A_V = 10$                                   |                            | 0.5%   |      |                        |
| Gain-bandwidth product                                  | $f = 10\text{ kHz},$<br>$C_L = 100\text{ pF}^\ddagger$  | $R_L = 2\text{ k}\Omega^\ddagger,$           | 25°C                       | 0.5    |      | MHz                    |
| $B_{OM}$ Maximum output-swing bandwidth                 | $V_{O(PP)} = 1\text{ V},$<br>$R_L = 2\text{ k}\Omega^\ddagger,$   | $A_V = 1,$<br>$C_L = 100\text{ pF}^\ddagger$ | 25°C                       | 220    |      | kHz                    |
| $t_s$ Settling time                                     | $A_V = -1,$<br>Step = 0.5 V to 2.5 V,<br>$R_L = 2\text{ k}\Omega^\ddagger,$<br>$C_L = 100\text{ pF}^\ddagger$ | $T_o = 0.1\%$                                | 25°C                       | 6.4    |      | $\mu$ s                |
|   |   | $T_o = 0.01\%$                               |                            | 14.1   |      |                        |
| $\phi_m$ Phase margin at unity gain                     |   |  | 25°C                       | 62°    |      |                        |
| Gain margin   | $R_L = 2\text{ k}\Omega^\ddagger,$  | $C_L = 100\text{ pF}^\ddagger$               | 25°C                       | 11     |      | dB                     |

$^\dagger$  Full range is  $-40^\circ\text{C}$  to  $125^\circ\text{C}$  for Q level part.

$^\ddagger$  Referenced to 2.5 V



**TLV2432-Q1, TLV2432A-Q1, TLV2434-Q1, TLV2434A-Q1**  
**Advanced LinCMOS™ RAIL-TO-RAIL OUTPUT**  
**WIDE-INPUT-VOLTAGE OPERATIONAL AMPLIFIERS**

SGLS182B – SEPTEMBER 2003 – REVISED NOVEMBER 2010

**electrical characteristics at specified free-air temperature,  $V_{DD} = 5\text{ V}$  (unless otherwise noted)**

| PARAMETER  | TEST CONDITIONS   |  | $T_A^\dagger$ | TLV243x-Q1                        |               |                              | UNIT          |
|--|---|--|---------------|-----------------------------------|---------------|------------------------------|---------------|
|  |   |  |               | MIN                               | TYP           | MAX                          |               |
| $V_{IO}$ Input offset voltage  | $V_{IC} = 0,$<br>$V_O = 0,$<br>$V_{DD} \pm = \pm 2.5\text{ V},$<br>$R_S = 50\ \Omega$ | TLV243x  | 25°C          | 300                               | 2000          | $\mu\text{V}$                |               |
|  |   |  | Full range    | 2500                              |               |                              |               |
|  |   | TLV243xA   | 25°C          | 300                               | 950           |                              |               |
|  |   |  | Full range    | 2000                              |               |                              |               |
| $\alpha_{V_{IO}}$ Temperature coefficient of input offset voltage          |   |  | 25°C to 70°C  | 2                                 |               | $\mu\text{V}/^\circ\text{C}$ |               |
| Input offset voltage long-term drift (see Note 4)                          |   |  | 25°C          | 0.003                             |               | $\mu\text{V}/\text{mo}$      |               |
| $I_{IO}$ Input offset current  | $V_{IC} = 0,$<br>$V_O = 0,$   | $V_{DD} \pm = \pm 2.5\text{ V},$<br>$R_S = 50\ \Omega$ | 25°C          | 0.5                               |               | pA                           |               |
|  |   |  | Full range    | 150                               |               |                              |               |
| $I_{IB}$ Input bias current  |   |  | 25°C          | 1                                 |               | pA                           |               |
|  |   |  | Full range    | 300                               |               |                              |               |
| $V_{ICR}$ Common-mode input voltage range                                  | $ V_{IO}  \leq 5\text{ mV},$  | $R_S = 50\ \Omega$                                     | 25°C          | 0 to 4.5                          | -0.25 to 4.75 | V                            |               |
|  |   |  | Full range    | 0 to 4.2                          |               |                              |               |
| $V_{OH}$ High-level output voltage   | $I_{OH} = -100\ \mu\text{A}$  |  | 25°C          | 4.97                              |               | V                            |               |
|  | $I_{OH} = -5\text{ mA}$   |  | 25°C          | 4                                 | 4.35          |                              |               |
|  |   |  | Full range    | 4                                 |               |                              |               |
| $V_{OL}$ Low-level output voltage  | $V_{IC} = 2.5\text{ V},$  | $I_{OL} = 100\ \mu\text{A}$                            | 25°C          | 0.01                              |               | V                            |               |
|  | $V_{IC} = 2.5\text{ V},$  | $I_{OL} = 5\text{ mA}$                                 | 25°C          | 0.8                               |               |                              |               |
|  |   |  | Full range    | 1.25                              |               |                              |               |
| $A_{VD}$ Large-signal differential voltage amplification                   | $V_{IC} = 2.5\text{ V},$<br>$V_O = 1\text{ V to }4\text{ V}$                          | $R_L = 2\text{ k}\Omega^\ddagger$                      | 25°C          | 2.5                               | 3.8           | V/mV                         |               |
|  |   |  | Full range    | 0.5                               |               |                              |               |
|  |   |  |               | $R_L = 1\text{ M}\Omega^\ddagger$ | 25°C          |                              | 950           |
| $r_{i(d)}$ Differential input resistance                                   |   |  | 25°C          | 1000                              |               | G $\Omega$                   |               |
| $r_{i(c)}$ Common-mode input resistance                                    |   |  | 25°C          | 1000                              |               | G $\Omega$                   |               |
| $C_{i(c)}$ Common-mode input capacitance                                   | $f = 10\text{ kHz}$   |  | 25°C          | 8                                 |               | pF                           |               |
| $Z_o$ Closed-loop output impedance   | $f = 100\text{ kHz},$ $A_V = 10$  |  | 25°C          | 130                               |               | $\Omega$                     |               |
| CMRR Common-mode rejection ratio   | $V_{IC} = V_{ICR\text{ MIN}},$ $V_O = 2.5\text{ V},$<br>$R_S = 50\ \Omega$            |  |               | 25°C                              | 70            | 90                           | dB            |
|  |   |  |               | Full range                        | 70            |                              |               |
| $k_{SVR}$ Supply-voltage rejection ratio ( $\Delta V_{DD}/\Delta V_{IO}$ ) | $V_{DD} = 4.4\text{ V to }8\text{ V},$<br>$V_{IC} = V_{DD}/2,$ No load                |  |               | 25°C                              | 80            | 95                           | dB            |
|  |   |  |               | Full range                        | 80            |                              |               |
| $I_{DD}$ Supply current  | $V_O = 2.5\text{ V},$ No load   |  |               | 25°C                              | 200           | 250                          | $\mu\text{A}$ |
|  |   |  |               | Full range                        | 270           |                              |               |

$^\dagger$  Full range is  $-40^\circ\text{C}$  to  $125^\circ\text{C}$  for Q level part.

$^\ddagger$  Referenced to 2.5 V

NOTE 4: Typical values are based on the input offset voltage shift observed through 500 hours of operating life test at  $T_A = 150^\circ\text{C}$  extrapolated to  $T_A = 25^\circ\text{C}$  using the Arrhenius equation and assuming an activation energy of 0.96 eV.



**TLV2432-Q1, TLV2432A-Q1, TLV2434-Q1, TLV2434A-Q1**  
**Advanced LinCMOS™ RAIL-TO-RAIL OUTPUT**  
**WIDE-INPUT-VOLTAGE OPERATIONAL AMPLIFIERS**

SGLS182B – SEPTEMBER 2003 – REVISED NOVEMBER 2010

operating characteristics at specified free-air temperature,  $V_{DD} = 5\text{ V}$

| PARAMETER   | TEST CONDITIONS   | $T_A^\dagger$  | TLV243x-Q1,<br>TLV243xA-Q1 |      |                        | UNIT |
|---|---|--|----------------------------|------|------------------------|------|
|   |   |  | MIN                        | TYP  | MAX                    |      |
| SR Slew rate at unity gain                              | $V_O = 1.5\text{ V to }3.5\text{ V},$<br>$R_L = 2\text{ k}\Omega^\ddagger,$<br>$C_L = 100\text{ pF}^\ddagger$ | 25°C   | 0.15                       | 0.25 | V/ $\mu$ s             |      |
|   |   | Full range   | 0.1                        |      |                        |      |
| $V_n$ Equivalent input noise voltage                    | $f = 10\text{ Hz}$  | 25°C   | 100                        |      | nV/ $\sqrt{\text{Hz}}$ |      |
|   | $f = 1\text{ kHz}$  | 25°C   | 18                         |      |                        |      |
| $V_{N(PP)}$ Peak-to-peak equivalent input noise voltage | $f = 0.1\text{ Hz to }1\text{ Hz}$  | 25°C   | 1.9                        |      | $\mu$ V                |      |
|   | $f = 0.1\text{ Hz to }10\text{ Hz}$   | 25°C   | 2.8                        |      |                        |      |
| $I_n$ Equivalent input noise current                    |   | 25°C   | 0.6                        |      | fA/ $\sqrt{\text{Hz}}$ |      |
| THD + N Total harmonic distortion plus noise            | $V_O = 1.5\text{ V to }3.5\text{ V},$<br>$f = 1\text{ kHz},$<br>$R_L = 2\text{ k}\Omega^\ddagger$             | $A_V = 1$  | 0.045%                     |      |                        |      |
|   |   | $A_V = 10$   | 0.4%                       |      |                        |      |
| Gain-bandwidth product                                  | $f = 10\text{ kHz},$<br>$C_L = 100\text{ pF}^\ddagger$  | $R_L = 2\text{ k}\Omega^\ddagger,$<br>25°C           | 0.55                       |      | MHz                    |      |
| $B_{OM}$ Maximum output-swing bandwidth                 | $V_{O(PP)} = 2\text{ V},$<br>$R_L = 2\text{ k}\Omega^\ddagger,$   | $A_V = 1,$<br>$C_L = 100\text{ pF}^\ddagger$<br>25°C | 100                        |      | kHz                    |      |
| $t_s$ Settling time                                     | $A_V = -1,$<br>Step = 1.5 V to 3.5 V,<br>$R_L = 2\text{ k}\Omega^\ddagger,$<br>$C_L = 100\text{ pF}^\ddagger$ | $T_o = 0.1\%$  | 6.4                        |      | $\mu$ s                |      |
|   |   | $T_o = 0.01\%$                                       | 13.1                       |      |                        |      |
| $\phi_m$ Phase margin at unity gain                     | $R_L = 2\text{ k}\Omega^\ddagger,$<br>$C_L = 100\text{ pF}^\ddagger$  | 25°C   | 66°                        |      |                        |      |
| Gain margin   |   | 25°C   | 11                         |      | dB                     |      |

$^\dagger$  Full range is  $-40^\circ\text{C}$  to  $125^\circ\text{C}$  for Q level part.

$^\ddagger$  Referenced to 2.5 V



**TLV2432-Q1, TLV2432A-Q1, TLV2434-Q1, TLV2434A-Q1**  
**Advanced LinCMOS™ RAIL-TO-RAIL OUTPUT**  
**WIDE-INPUT-VOLTAGE OPERATIONAL AMPLIFIERS**

SGLS182B – SEPTEMBER 2003 – REVISED NOVEMBER 2010

**TYPICAL CHARACTERISTICS**

**Table of Graphs**

|                 |   |  | FIGURE     |
|-----------------|---|--|------------|
| $V_{IO}$        | Input offset voltage                            | Distribution<br>vs Common-mode input voltage | 2,3<br>4,5 |
| $\alpha_{VIO}$  | Temperature coefficient                         | Distribution                                 | 6,7        |
| $I_{IB}/I_{IO}$ | Input bias and input offset currents            | vs Free-air temperature                      | 8          |
| $V_{OH}$        | High-level output voltage                       | vs High-level output current                 | 9,11       |
| $V_{OL}$        | Low-level output voltage                        | vs Low-level output current                  | 10,12      |
| $V_{O(PP)}$     | Maximum peak-to-peak output voltage             | vs Frequency                                 | 13         |
| $I_{OS}$        | Short-circuit output current                    | vs Supply voltage                            | 14         |
|                 |   | vs Free-air temperature                      | 15         |
| $V_{ID}$        | Differential input voltage                      | vs Output voltage                            | 16,17      |
|                 |   | Differential gain                            | 18         |
| $A_{VD}$        | Large-signal differential voltage amplification | vs Frequency                                 | 19,20      |
| $A_{VD}$        | Differential voltage amplification              | vs Free-air temperature                      | 21,22      |
| $z_o$           | Output impedance                                | vs Frequency                                 | 23,24      |
| CMRR            | Common-mode rejection ratio                     | vs Frequency                                 | 25         |
|                 |   | vs Free-air temperature                      | 26         |
| $k_{SVR}$       | Supply-voltage rejection ratio                  | vs Frequency                                 | 27,28      |
|                 |   | vs Free-air temperature                      | 29         |
| $I_{DD}$        | Supply current                                  | vs Supply voltage                            | 30         |
| SR              | Slew rate                                       | vs Load capacitance                          | 31         |
|                 |   | vs Free-air temperature                      | 32         |
| $V_O$           | Inverting large-signal pulse response           |  | 33,34      |
| $V_O$           | Voltage-follower large-signal pulse response    |  | 35,36      |
| $V_O$           | Inverting small-signal pulse response           |  | 37,38      |
| $V_O$           | Voltage-follower small-signal pulse response    |  | 39,40      |
| $V_n$           | Equivalent input noise voltage                  | vs Frequency                                 | 41, 42     |
|                 |   | Noise voltage (referred to input)            | 43         |
| THD + N         | Total harmonic distortion plus noise            | vs Frequency                                 | 44,45      |
|                 |   | Gain-bandwidth product                       | 46<br>47   |
| $\phi_m$        | Phase margin                                    | vs Frequency                                 | 19,20      |
|                 |   | vs Load capacitance                          | 48         |
| $B_1$           | Unity-gain bandwidth                            | vs Load capacitance                          | 49         |
|                 |   |  | 50         |

**TLV2432-Q1, TLV2432A-Q1, TLV2434-Q1, TLV2434A-Q1**  
**Advanced LinCMOS™ RAIL-TO-RAIL OUTPUT**  
**WIDE-INPUT-VOLTAGE OPERATIONAL AMPLIFIERS**

SGLS182B – SEPTEMBER 2003 – REVISED NOVEMBER 2010

**TYPICAL CHARACTERISTICS**

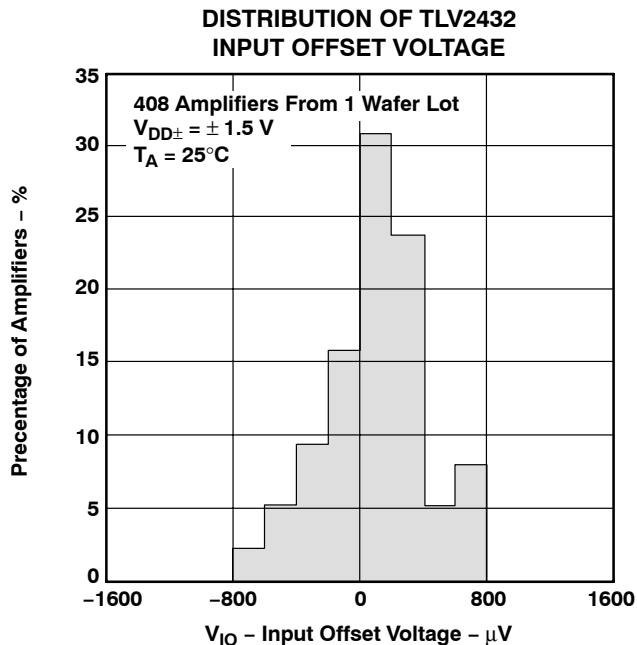

**Figure 2**

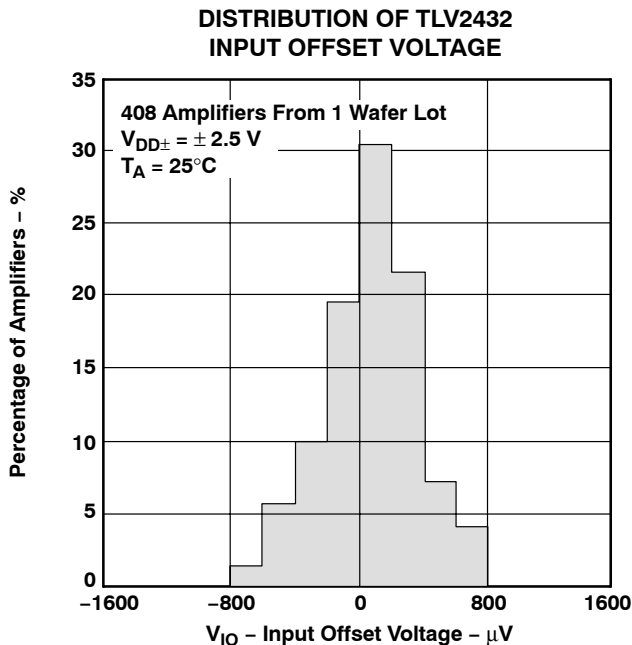

**Figure 3**

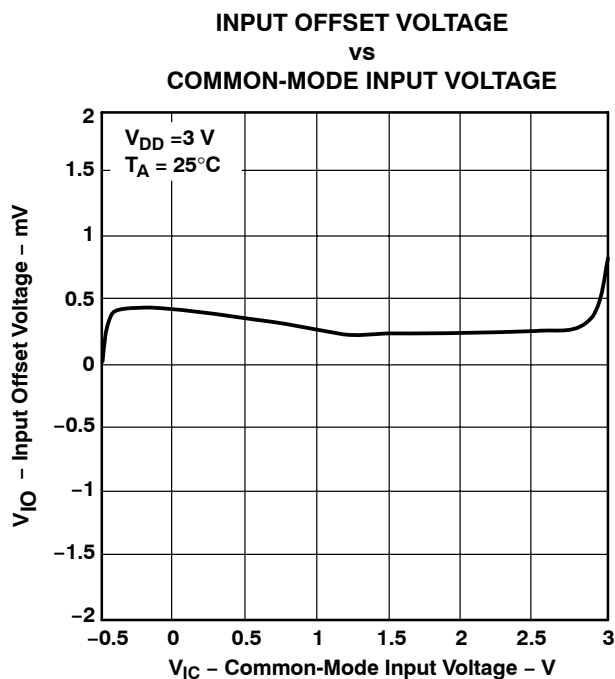

**Figure 4**

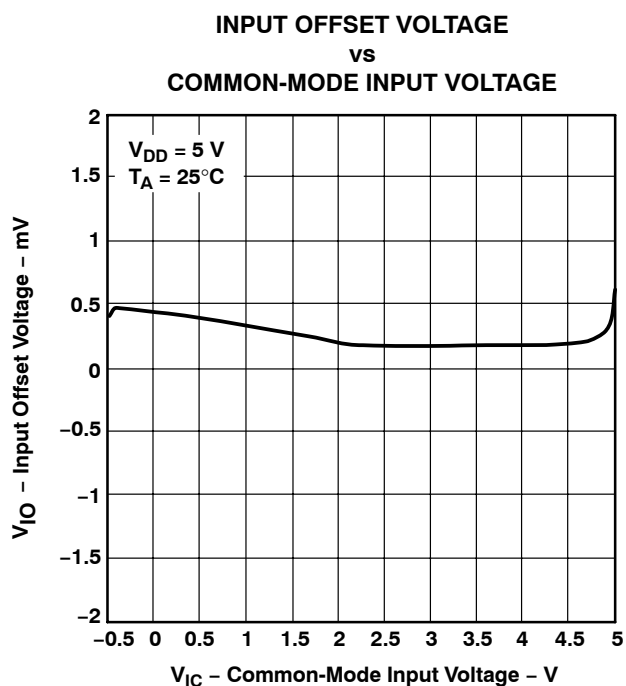

**Figure 5**



TYPICAL CHARACTERISTICS

DISTRIBUTION OF TLV2432 INPUT OFFSET VOLTAGE TEMPERATURE COEFFICIENT

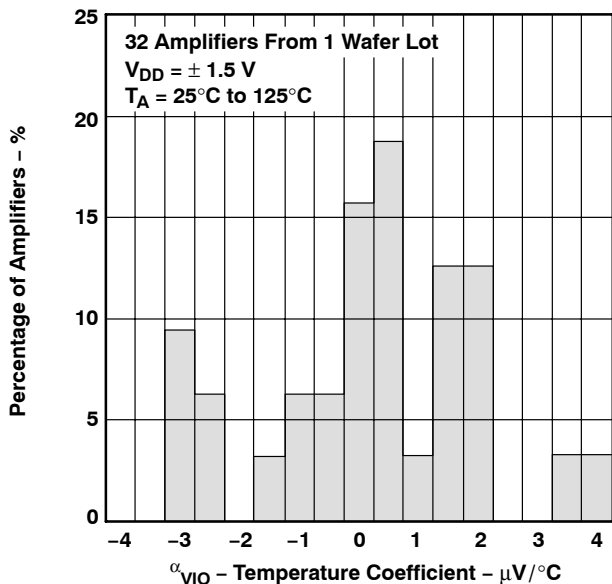

Figure 6

DISTRIBUTION OF TLV2432 INPUT OFFSET VOLTAGE TEMPERATURE COEFFICIENT

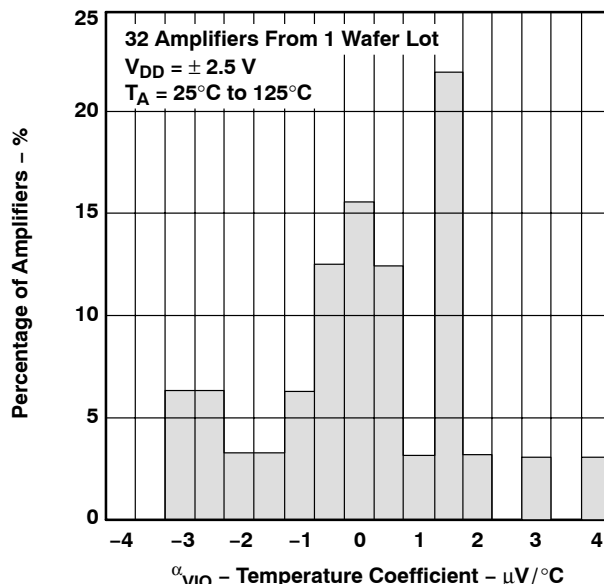

Figure 7

INPUT BIAS AND INPUT OFFSET CURRENTS vs FREE-AIR TEMPERATURE

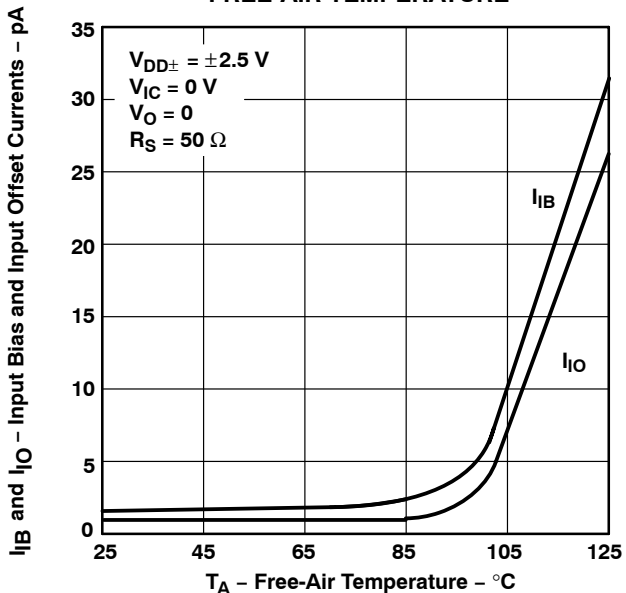

Figure 8

HIGH-LEVEL OUTPUT VOLTAGE vs HIGH-LEVEL OUTPUT CURRENT

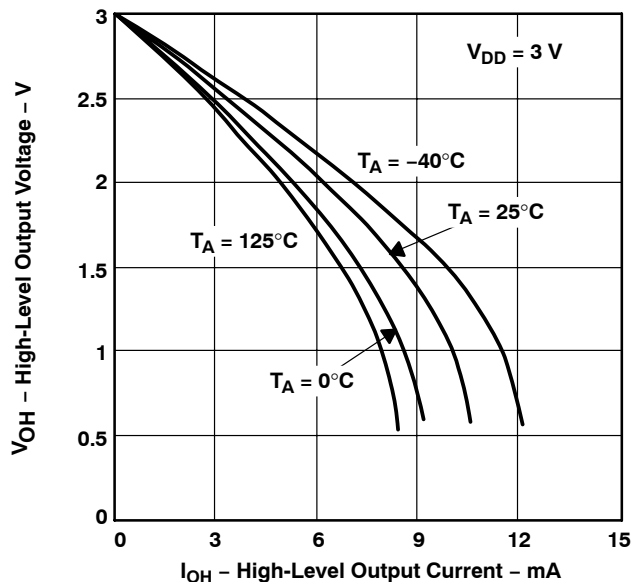
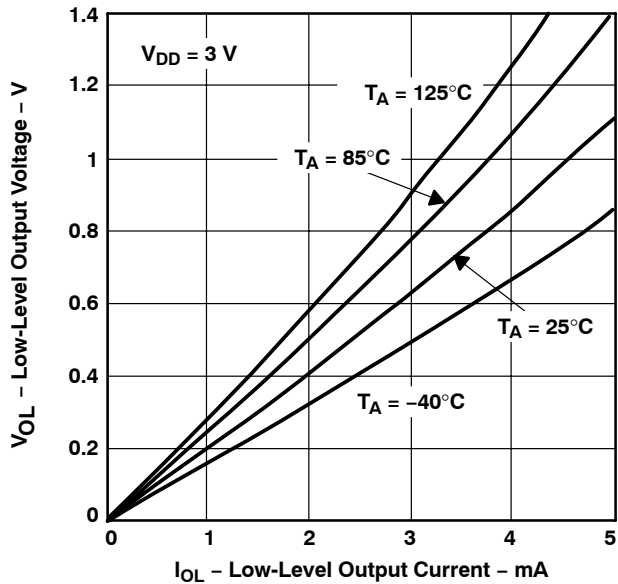

Figure 9

**TYPICAL CHARACTERISTICS**

**LOW-LEVEL OUTPUT VOLTAGE  
vs  
LOW-LEVEL OUTPUT CURRENT**



**Figure 10**

**HIGH-LEVEL OUTPUT VOLTAGE  
vs  
HIGH-LEVEL OUTPUT CURRENT**

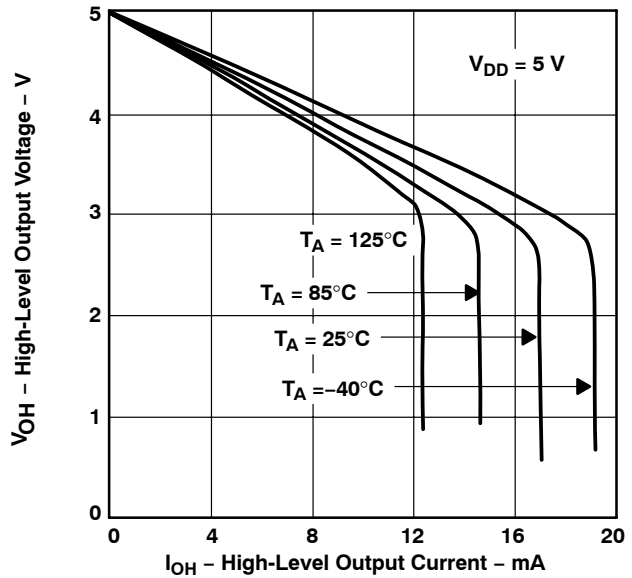

**Figure 11**

**LOW-LEVEL OUTPUT VOLTAGE  
vs  
LOW-LEVEL OUTPUT CURRENT**

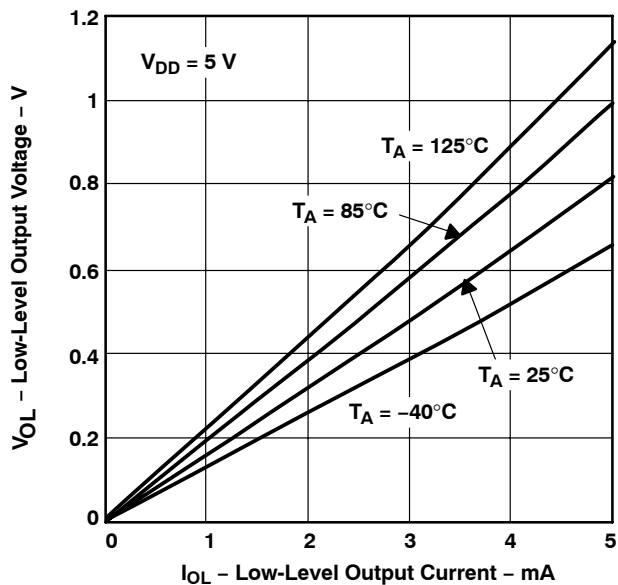

**Figure 12**

**MAXIMUM PEAK-TO-PEAK OUTPUT VOLTAGE  
vs  
FREQUENCY**

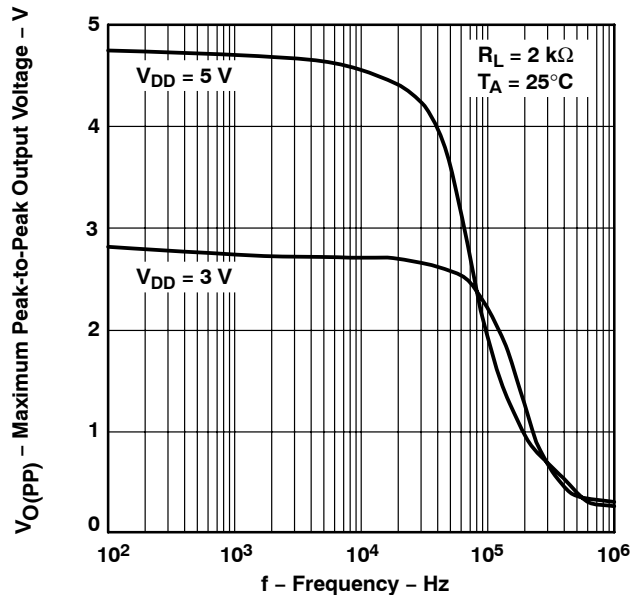

**Figure 13**

TLV2432-Q1, TLV2432A-Q1, TLV2434-Q1, TLV2434A-Q1  
 Advanced LinCMOS™ RAIL-TO-RAIL OUTPUT  
 WIDE-INPUT-VOLTAGE OPERATIONAL AMPLIFIERS

SGLS182B – SEPTEMBER 2003 – REVISED NOVEMBER 2010

TYPICAL CHARACTERISTICS

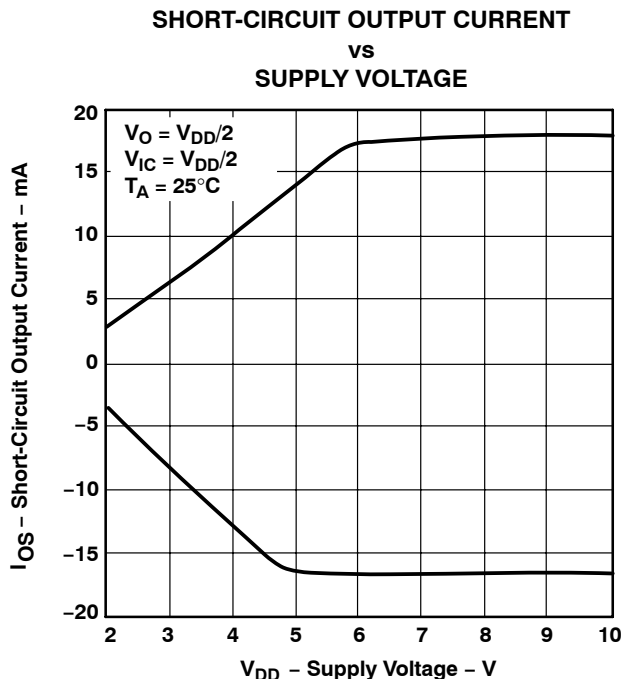

Figure 14

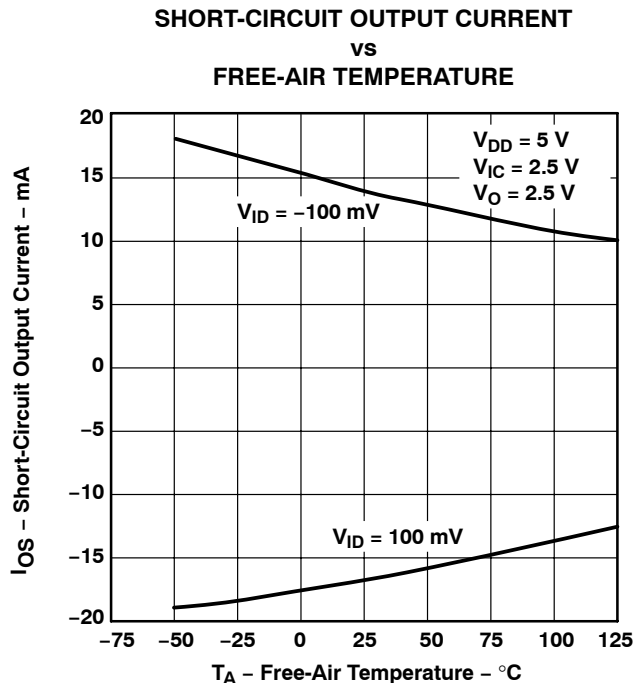

Figure 15

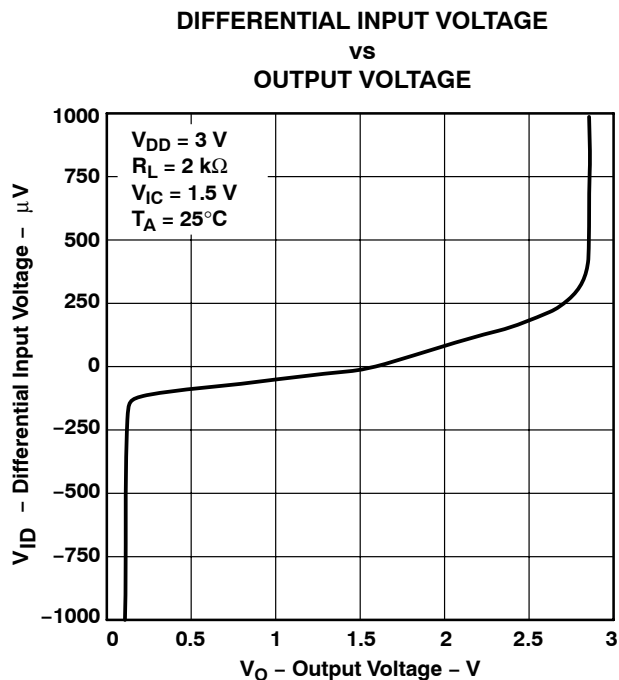

Figure 16

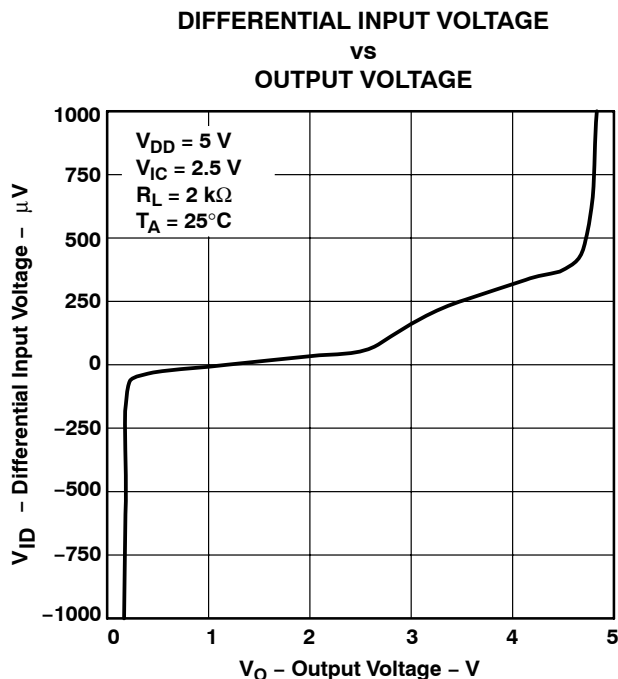
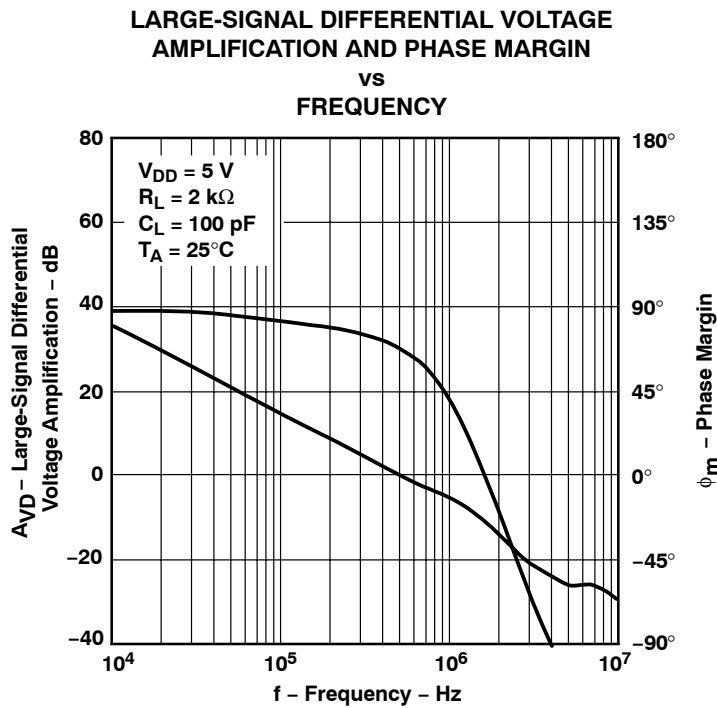
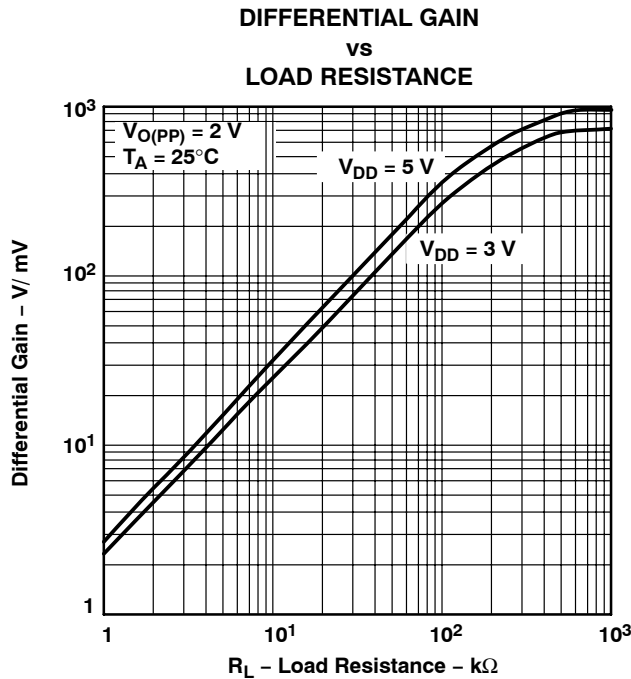

Figure 17

**TYPICAL CHARACTERISTICS**



TLV2432-Q1, TLV2432A-Q1, TLV2434-Q1, TLV2434A-Q1  
 Advanced LinCMOS™ RAIL-TO-RAIL OUTPUT  
 WIDE-INPUT-VOLTAGE OPERATIONAL AMPLIFIERS

SGLS182B – SEPTEMBER 2003 – REVISED NOVEMBER 2010

TYPICAL CHARACTERISTICS

LARGE-SIGNAL DIFFERENTIAL VOLTAGE  
 AMPLIFICATION AND PHASE MARGIN

vs  
 FREQUENCY

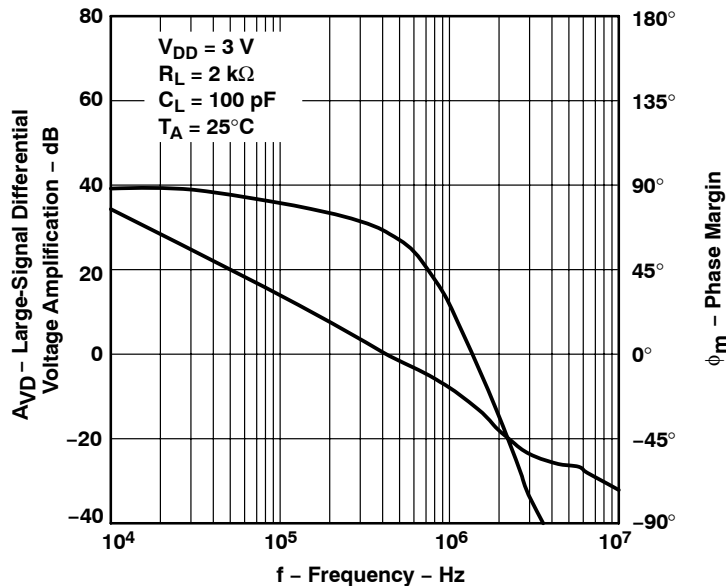

Figure 20

DIFFERENTIAL VOLTAGE AMPLIFICATION  
 vs  
 FREE-AIR TEMPERATURE

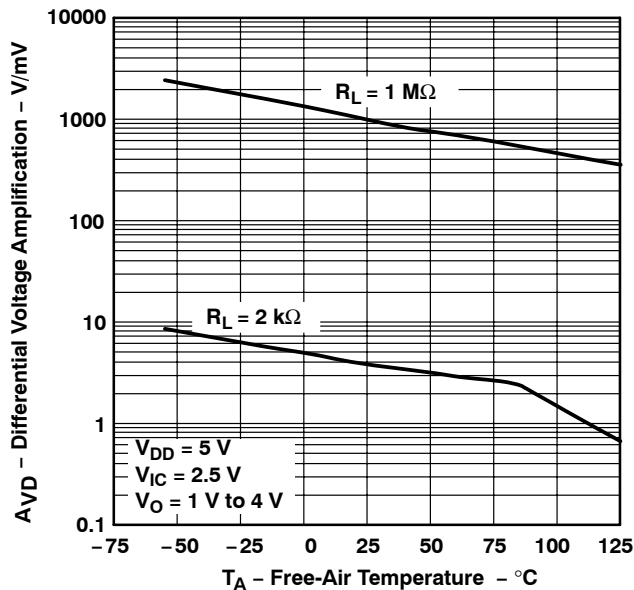

Figure 21

DIFFERENTIAL VOLTAGE AMPLIFICATION  
 vs  
 FREE-AIR TEMPERATURE

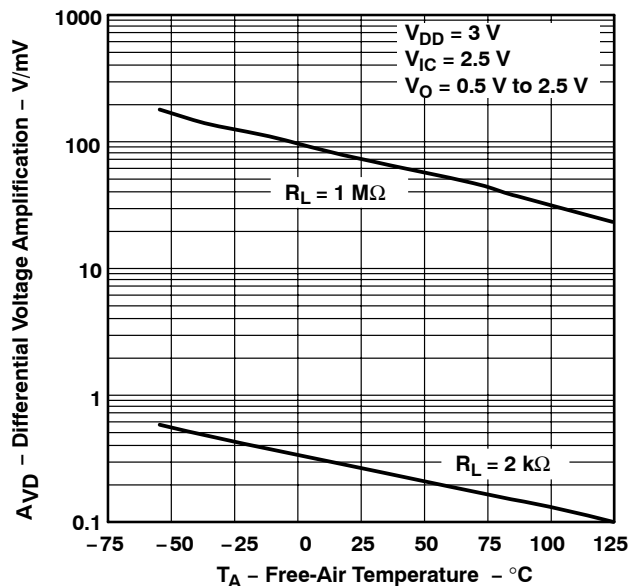
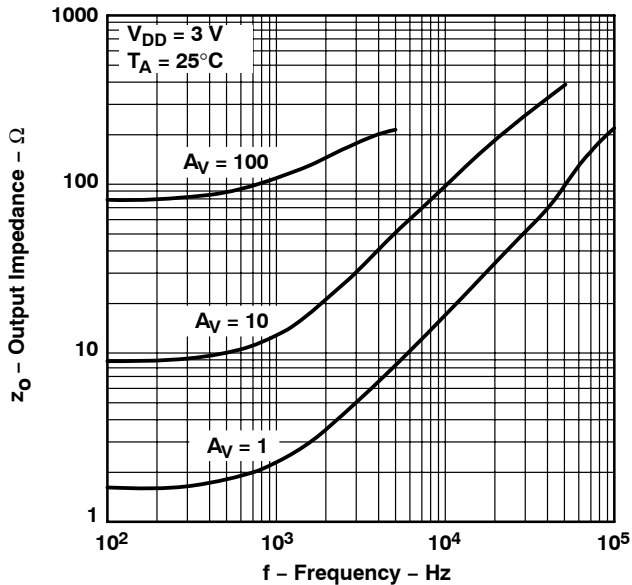

Figure 22



**TYPICAL CHARACTERISTICS**

**OUTPUT IMPEDANCE  
vs  
FREQUENCY**



**Figure 23**

**OUTPUT IMPEDANCE  
vs  
FREQUENCY**

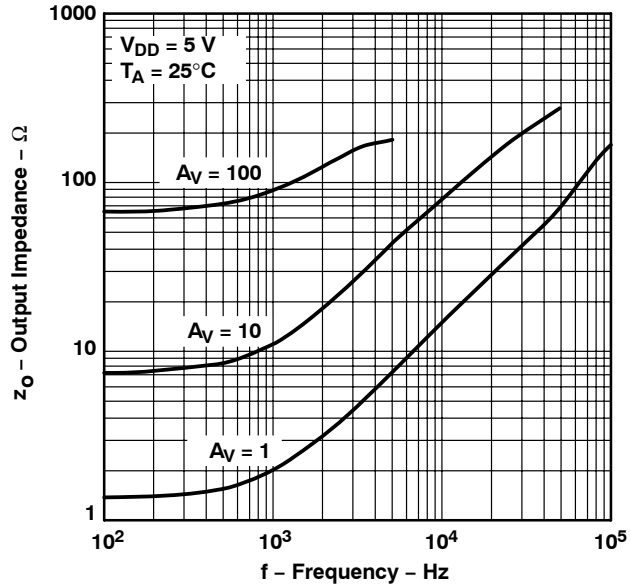

**Figure 24**

**COMMON-MODE REJECTION RATIO  
vs  
FREQUENCY**

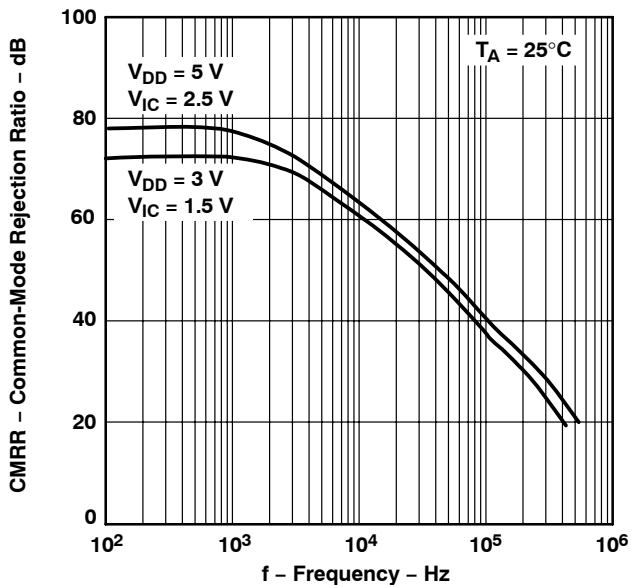

**Figure 25**

**COMMON-MODE REJECTION RATIO  
vs  
FREE-AIR TEMPERATURE**

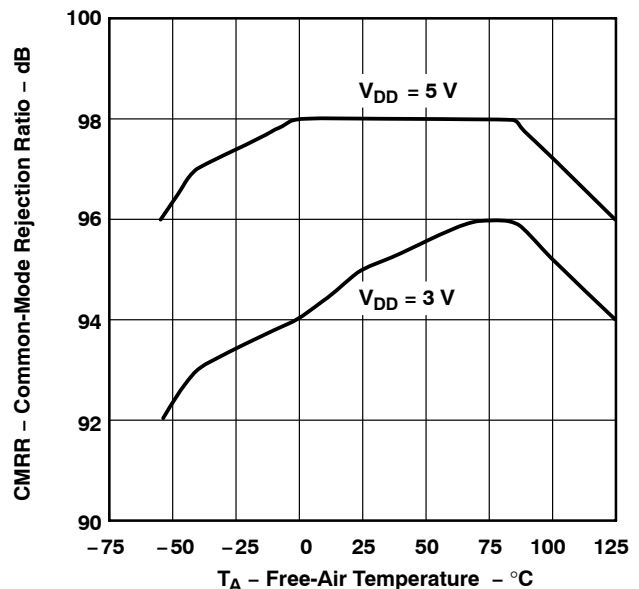

**Figure 26**



TLV2432-Q1, TLV2432A-Q1, TLV2434-Q1, TLV2434A-Q1  
 Advanced LinCMOS™ RAIL-TO-RAIL OUTPUT  
 WIDE-INPUT-VOLTAGE OPERATIONAL AMPLIFIERS

SGLS182B – SEPTEMBER 2003 – REVISED NOVEMBER 2010

TYPICAL CHARACTERISTICS

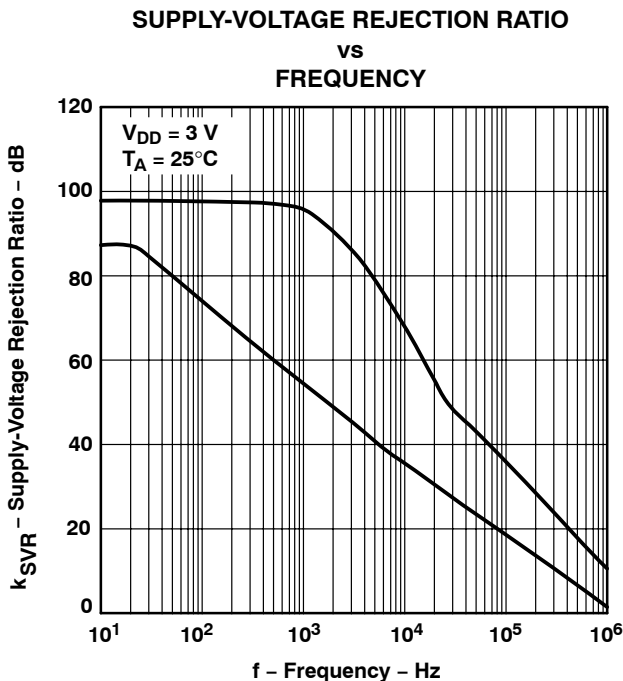

Figure 27

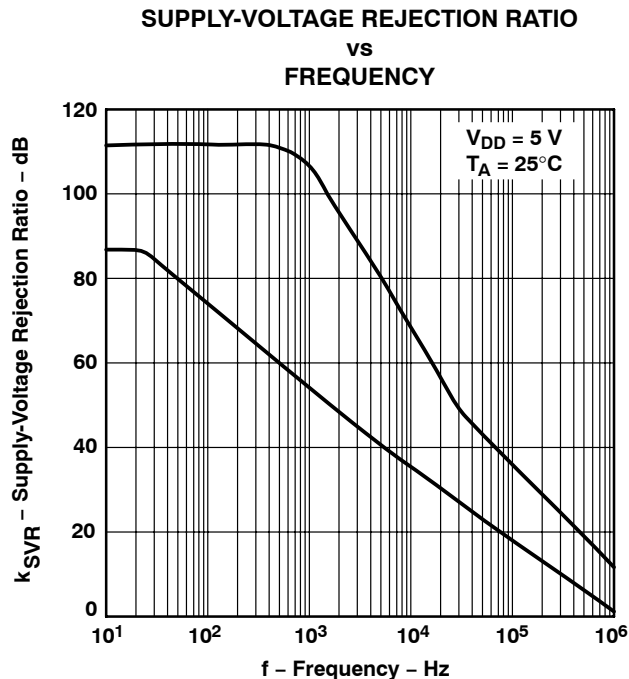

Figure 28

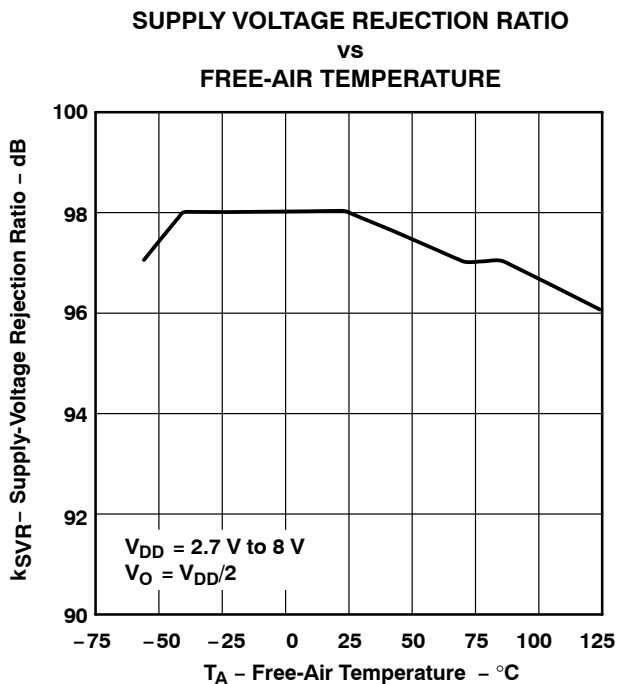

Figure 29

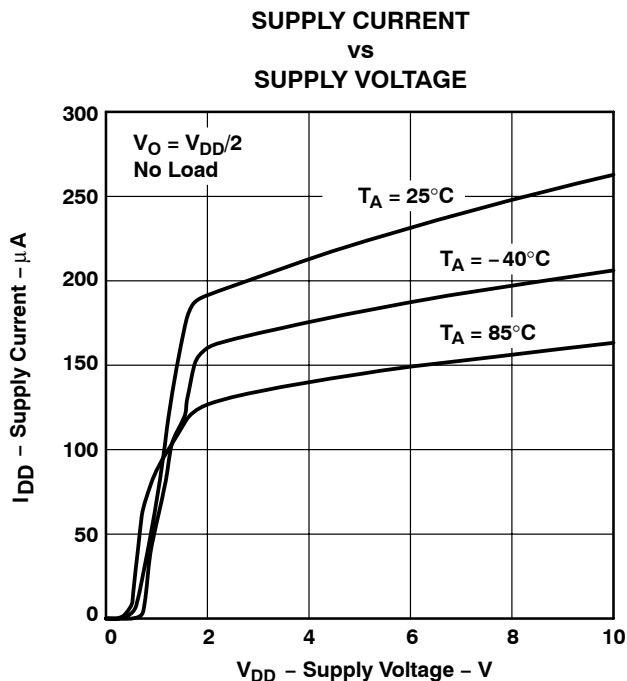
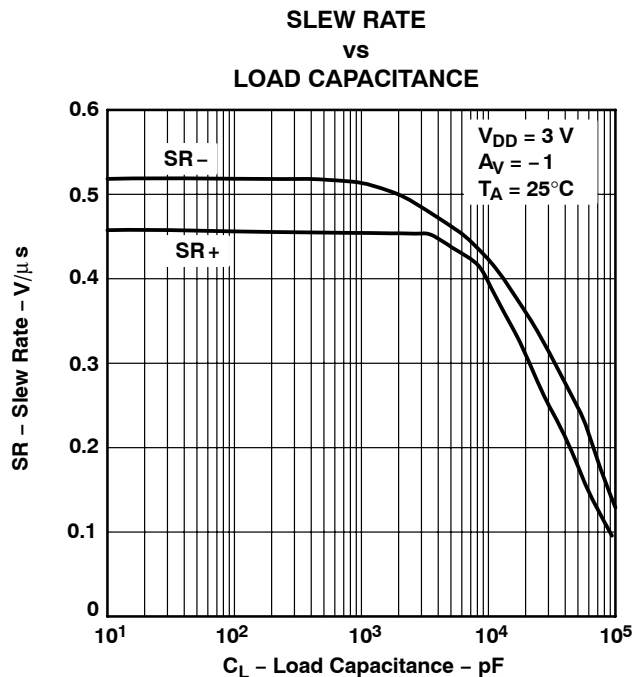

Figure 30

**TLV2432-Q1, TLV2432A-Q1, TLV2434-Q1, TLV2434A-Q1**  
**Advanced LinCMOS™ RAIL-TO-RAIL OUTPUT**  
**WIDE-INPUT-VOLTAGE OPERATIONAL AMPLIFIERS**

SGLS182B – SEPTEMBER 2003 – REVISED NOVEMBER 2010

**TYPICAL CHARACTERISTICS**



**Figure 31**

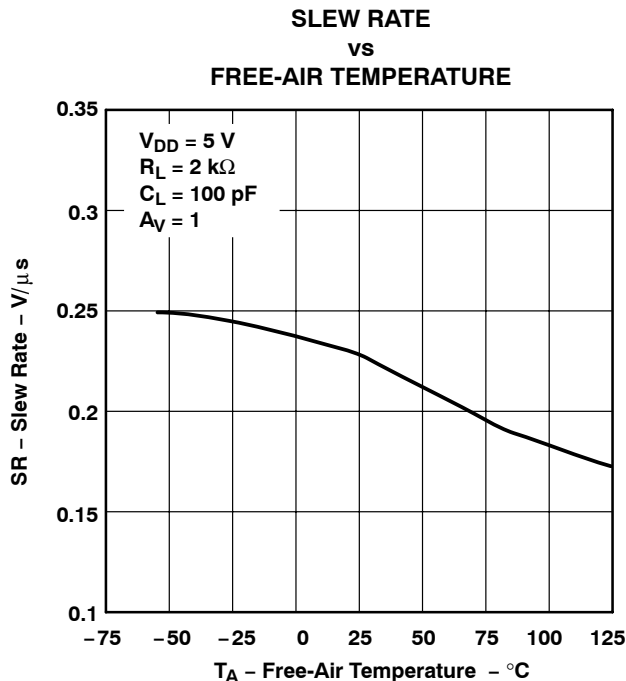

**Figure 32**

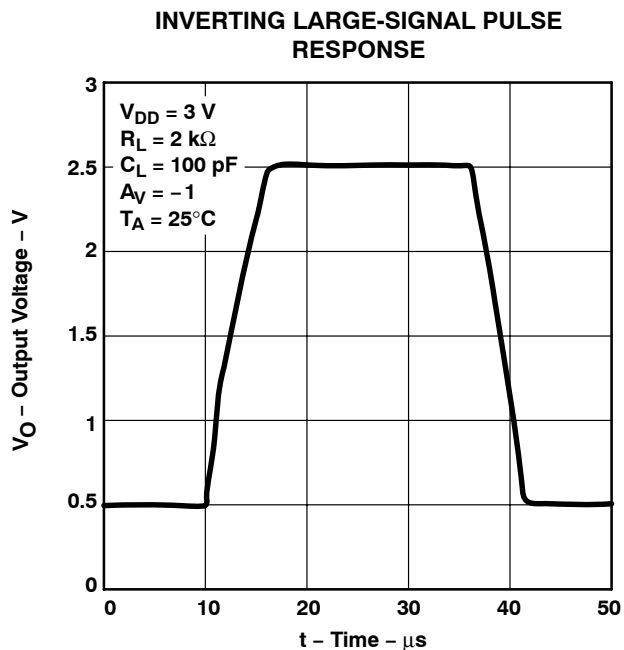

**Figure 33**

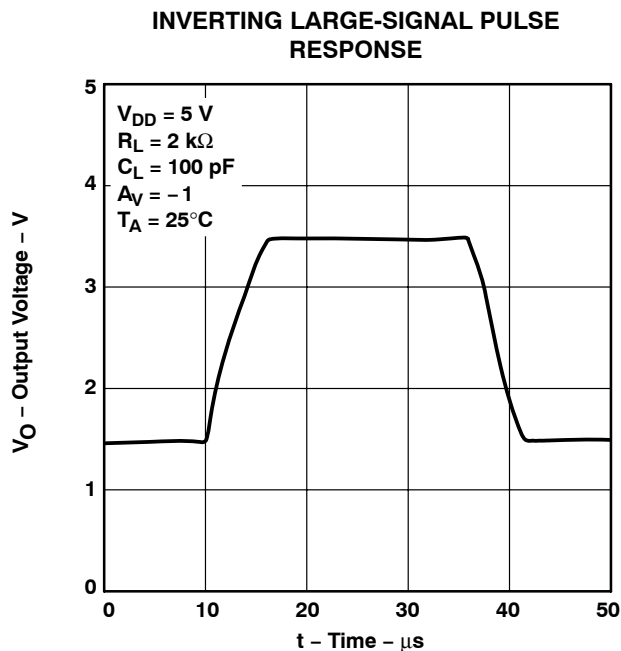

**Figure 34**



TYPICAL CHARACTERISTICS

VOLTAGE-FOLLOWER LARGE-SIGNAL PULSE RESPONSE

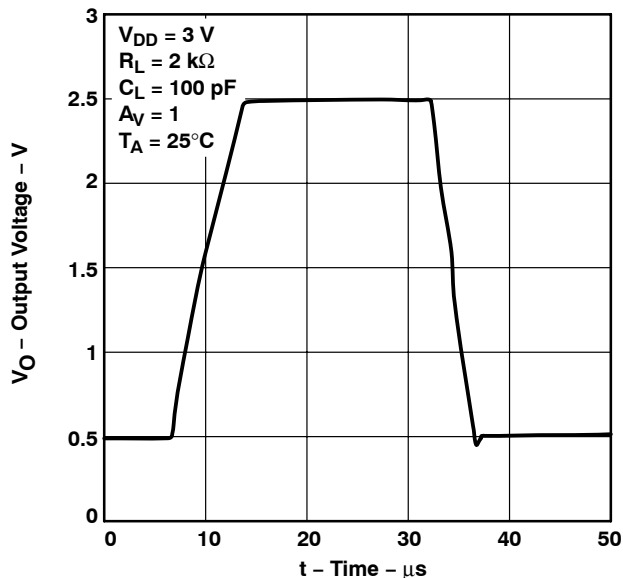

Figure 35

VOLTAGE-FOLLOWER LARGE-SIGNAL PULSE RESPONSE

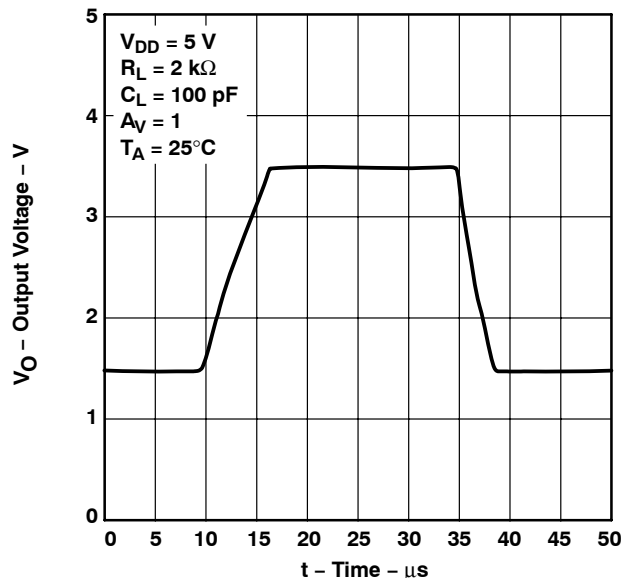

Figure 36

INVERTING SMALL-SIGNAL PULSE RESPONSE

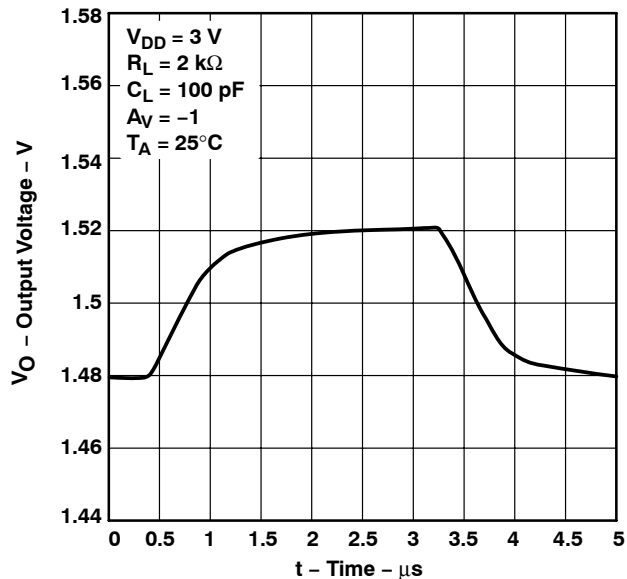

Figure 37

INVERTING SMALL-SIGNAL PULSE RESPONSE

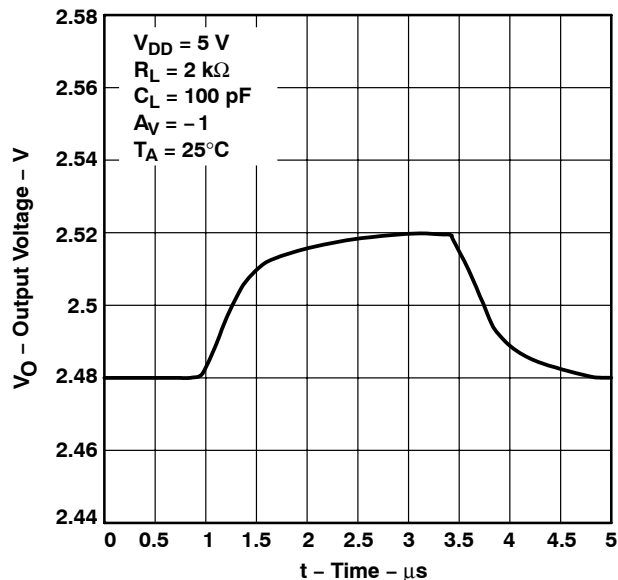

Figure 38

**TLV2432-Q1, TLV2432A-Q1, TLV2434-Q1, TLV2434A-Q1**  
**Advanced LinCMOS™ RAIL-TO-RAIL OUTPUT**  
**WIDE-INPUT-VOLTAGE OPERATIONAL AMPLIFIERS**

SGLS182B – SEPTEMBER 2003 – REVISED NOVEMBER 2010

**TYPICAL CHARACTERISTICS**

**VOLTAGE-FOLLOWER SMALL-SIGNAL PULSE RESPONSE**

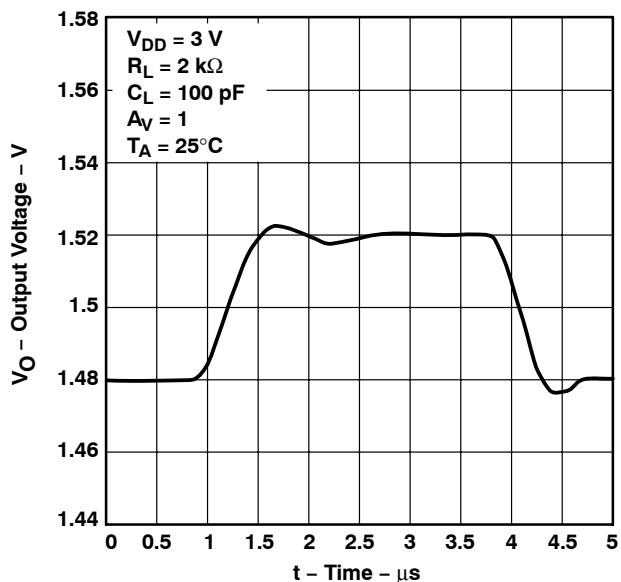

**Figure 39**

**VOLTAGE-FOLLOWER SMALL-SIGNAL PULSE RESPONSE**

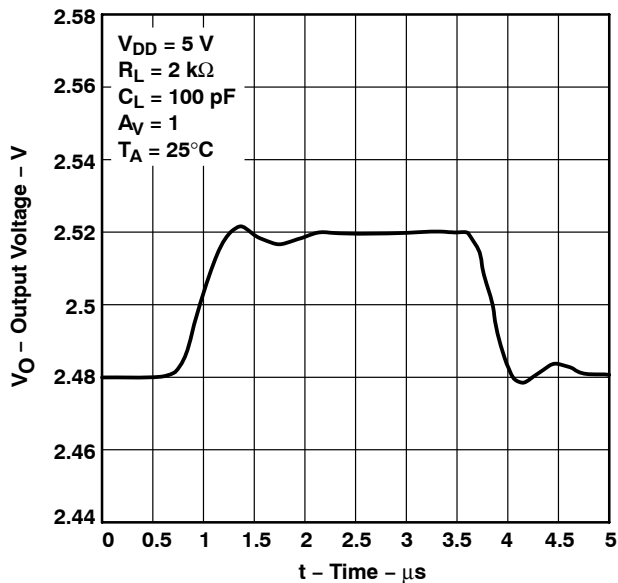

**Figure 40**

**EQUIVALENT INPUT NOISE VOLTAGE VS FREQUENCY**

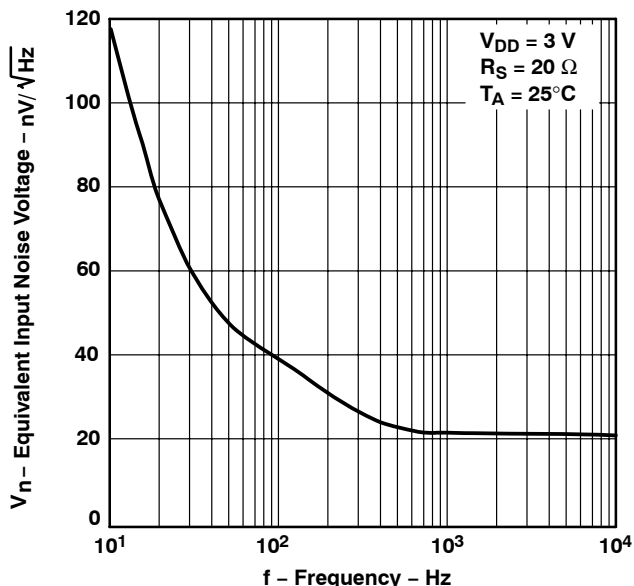

**Figure 41**

**EQUIVALENT INPUT NOISE VOLTAGE VS FREQUENCY**

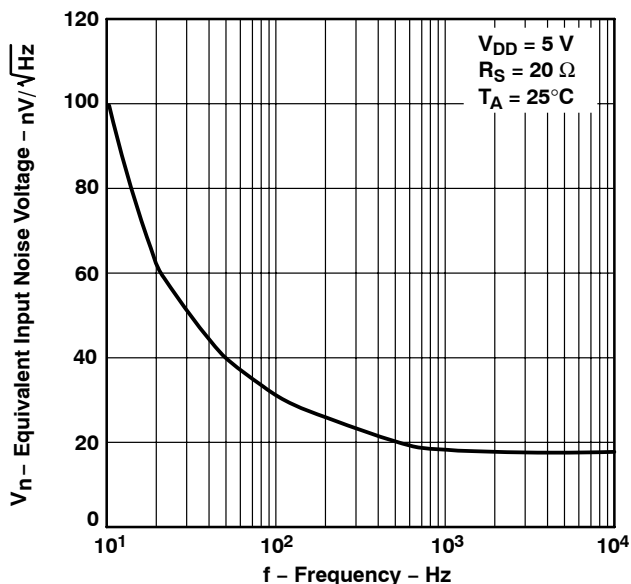

**Figure 42**



TLV2432-Q1, TLV2432A-Q1, TLV2434-Q1, TLV2434A-Q1  
 Advanced LinCMOS™ RAIL-TO-RAIL OUTPUT  
 WIDE-INPUT-VOLTAGE OPERATIONAL AMPLIFIERS

SGLS182B – SEPTEMBER 2003 – REVISED NOVEMBER 2010

TYPICAL CHARACTERISTICS

NOISE VOLTAGE OVER A 10-SECOND PERIOD

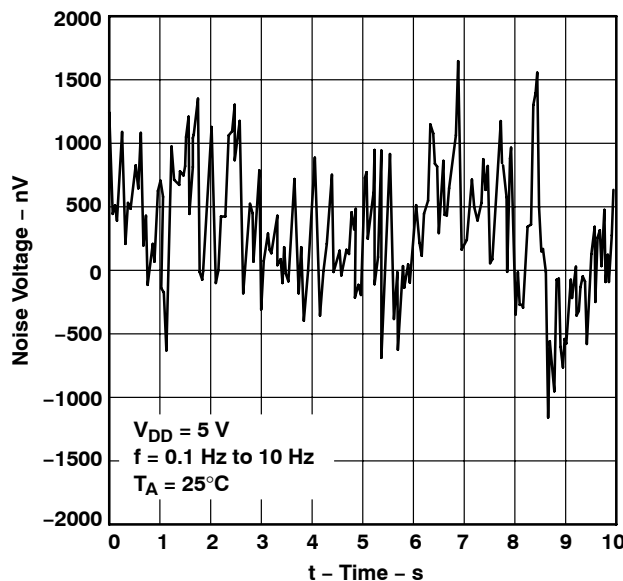

Figure 43

TOTAL HARMONIC DISTORTION PLUS NOISE  
 vs  
 FREQUENCY

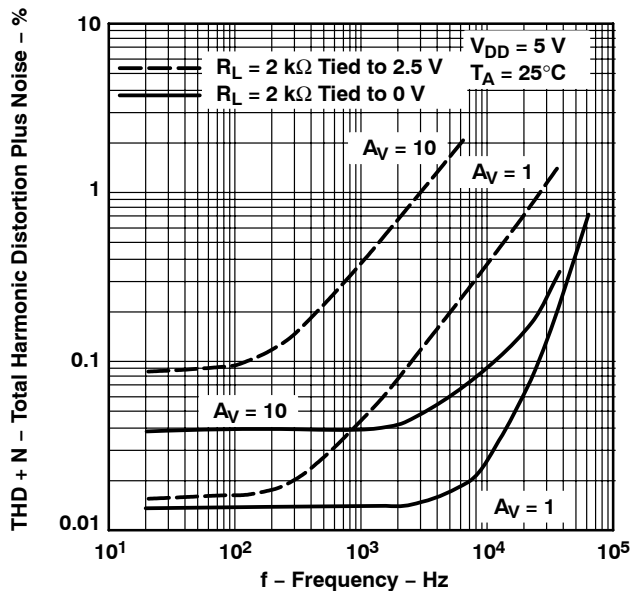

Figure 44

TOTAL HARMONIC DISTORTION PLUS NOISE  
 vs  
 FREQUENCY

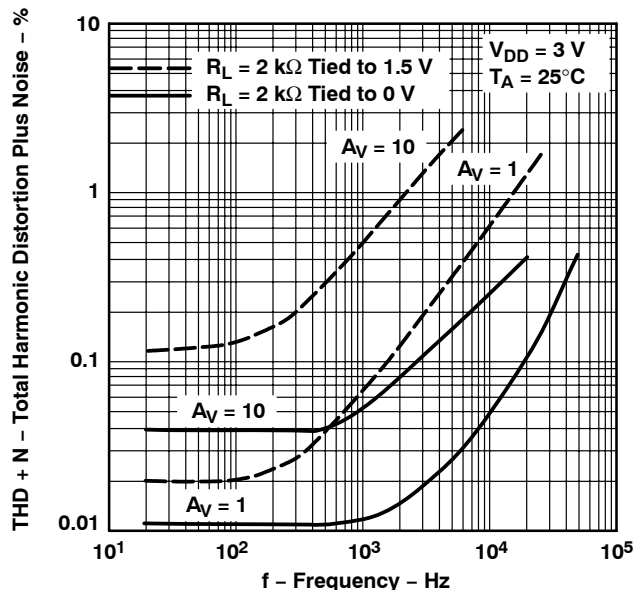
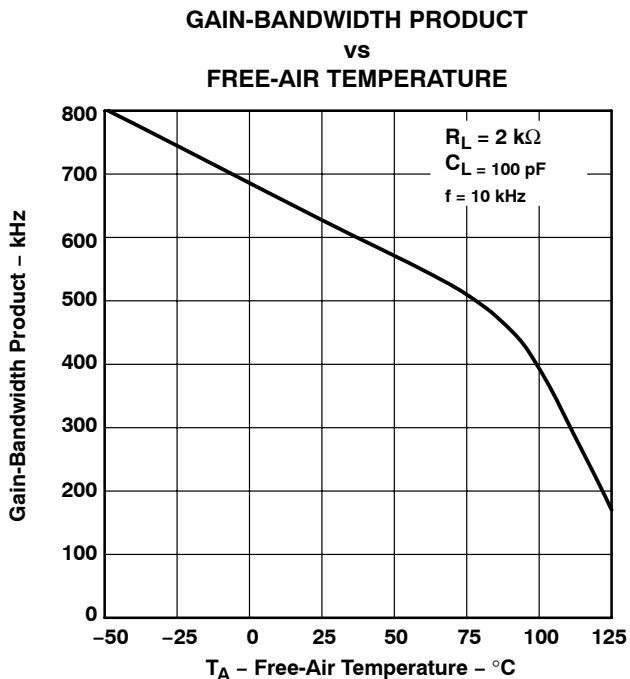
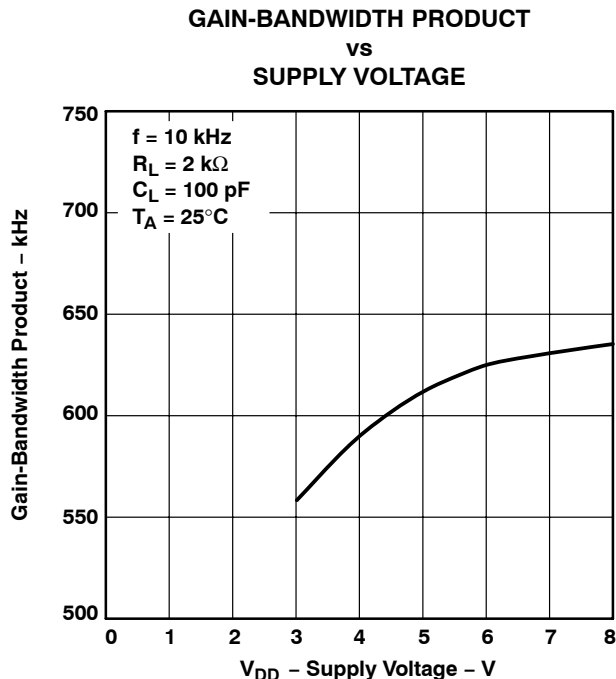

Figure 45

**TYPICAL CHARACTERISTICS**



**Figure 46**



**Figure 47**

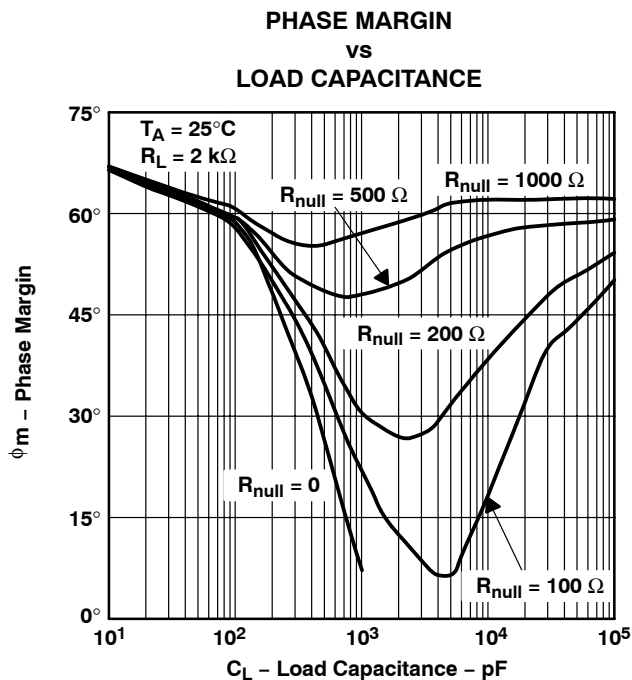

**Figure 48**

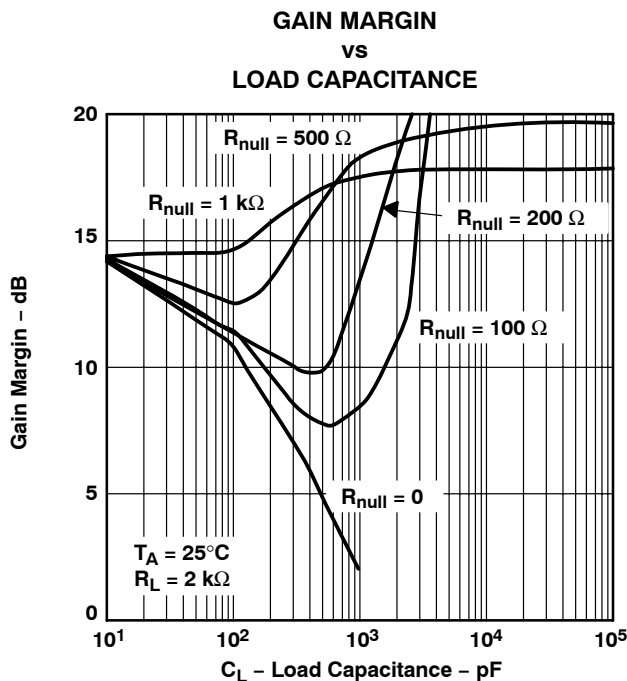

**Figure 49**

TLV2432-Q1, TLV2432A-Q1, TLV2434-Q1, TLV2434A-Q1  
Advanced LinCMOS™ RAIL-TO-RAIL OUTPUT  
WIDE-INPUT-VOLTAGE OPERATIONAL AMPLIFIERS

SGLS182B – SEPTEMBER 2003 – REVISED NOVEMBER 2010

TYPICAL CHARACTERISTICS

UNITY-GAIN BANDWIDTH  
vs  
LOAD CAPACITANCE

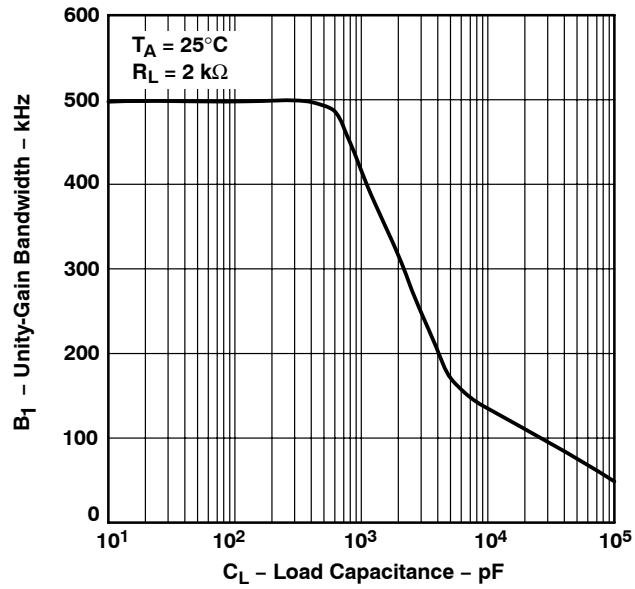

Figure 50

# TLV2432-Q1, TLV2432A-Q1, TLV2434-Q1, TLV2434A-Q1

## Advanced LinCMOS™ RAIL-TO-RAIL OUTPUT

### WIDE-INPUT-VOLTAGE OPERATIONAL AMPLIFIERS

SGLS182B – SEPTEMBER 2003 – REVISED NOVEMBER 2010

## APPLICATION INFORMATION

### macromodel information

Macromodel information provided was derived using Microsim *Parts*™, the model generation software used with Microsim *PSpice*™. The Boyle macromodel (see Note 5) and subcircuit in Figure 51 are generated using the TLV243x typical electrical and operating characteristics at  $T_A = 25^\circ\text{C}$ . Using this information, output simulations of the following key parameters can be generated to a tolerance of 20% (in most cases):

- Maximum positive output voltage swing
- Maximum negative output voltage swing
- Slew rate
- Quiescent power dissipation
- Input bias current
- Open-loop voltage amplification
- Unity-gain frequency
- Common-mode rejection ratio
- Phase margin
- DC output resistance
- AC output resistance
- Short-circuit output current limit

NOTE 4: G. R. Boyle, B. M. Cohn, D. O. Pederson, and J. E. Solomon, "Macromodeling of Integrated Circuit Operational Amplifiers", *IEEE Journal of Solid-State Circuits*, SC-9, 353 (1974).

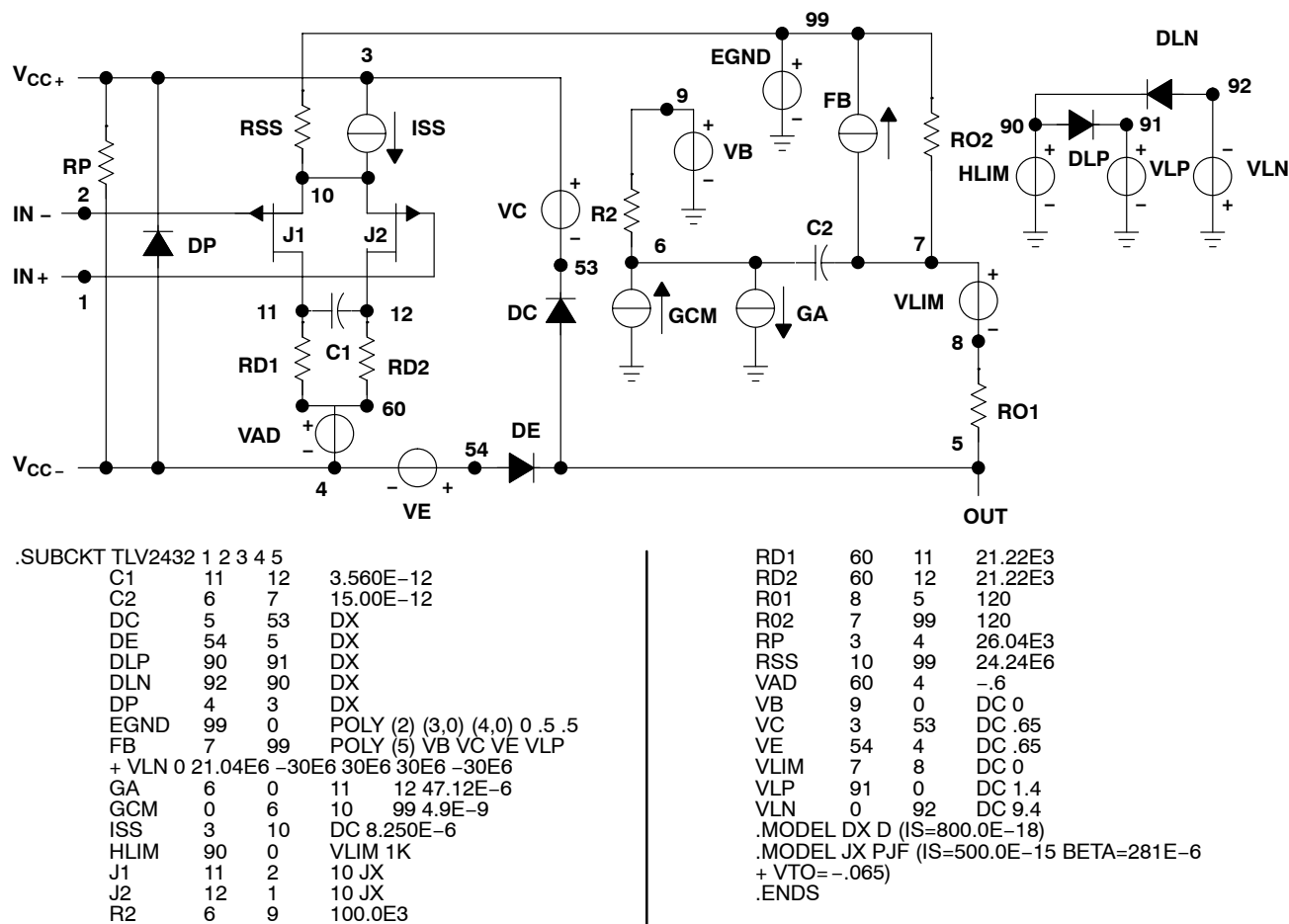

Figure 51. Boyle Macromodel and Subcircuit

*PSpice* and *Parts* are trademarks of MicroSim Corporation.



POST OFFICE BOX 655303 • DALLAS, TEXAS 75265



## PACKAGING INFORMATION

| Orderable Device | Status<br>(1) | Package Type | Package Drawing | Pins | Package Qty | Eco Plan<br>(2) | Lead finish/<br>Ball material<br>(6) | MSL Peak Temp<br>(3) | Op Temp (°C) | Device Marking<br>(4/5) | Samples |
|------------------|---------------|--------------|-----------------|------|-------------|-----------------|--------------------------------------|----------------------|--------------|-------------------------|---------|
| TLV2432AQDRQ1    | LIFEBUY       | SOIC         | D               | 8    | 2500        | RoHS & Green    | NIPDAU                               | Level-1-260C-UNLIM   | -40 to 125   | 2432AQ                  |         |
| TLV2432QDRG4Q1   | ACTIVE        | SOIC         | D               | 8    | 2500        | RoHS & Green    | NIPDAU                               | Level-1-260C-UNLIM   | -40 to 125   | 2432Q1                  | Samples |
| TLV2434AQDRQ1    | ACTIVE        | SOIC         | D               | 14   | 2500        | RoHS & Green    | NIPDAU                               | Level-1-260C-UNLIM   | -40 to 125   | 2434AQ                  | Samples |
| TLV2434AQPWRQ1   | ACTIVE        | TSSOP        | PW              | 14   | 2000        | RoHS & Green    | NIPDAU                               | Level-3-260C-168 HR  | -40 to 125   | 2434AQ                  | Samples |

(1) The marketing status values are defined as follows:

**ACTIVE:** Product device recommended for new designs.

**LIFEBUY:** TI has announced that the device will be discontinued, and a lifetime-buy period is in effect.

**NRND:** Not recommended for new designs. Device is in production to support existing customers, but TI does not recommend using this part in a new design.

**PREVIEW:** Device has been announced but is not in production. Samples may or may not be available.

**OBSOLETE:** TI has discontinued the production of the device.

(2) **RoHS:** TI defines "RoHS" to mean semiconductor products that are compliant with the current EU RoHS requirements for all 10 RoHS substances, including the requirement that RoHS substance do not exceed 0.1% by weight in homogeneous materials. Where designed to be soldered at high temperatures, "RoHS" products are suitable for use in specified lead-free processes. TI may reference these types of products as "Pb-Free".

**RoHS Exempt:** TI defines "RoHS Exempt" to mean products that contain lead but are compliant with EU RoHS pursuant to a specific EU RoHS exemption.

**Green:** TI defines "Green" to mean the content of Chlorine (Cl) and Bromine (Br) based flame retardants meet JS709B low halogen requirements of <=1000ppm threshold. Antimony trioxide based flame retardants must also meet the <=1000ppm threshold requirement.

(3) MSL, Peak Temp. - The Moisture Sensitivity Level rating according to the JEDEC industry standard classifications, and peak solder temperature.

(4) There may be additional marking, which relates to the logo, the lot trace code information, or the environmental category on the device.

(5) Multiple Device Markings will be inside parentheses. Only one Device Marking contained in parentheses and separated by a "~" will appear on a device. If a line is indented then it is a continuation of the previous line and the two combined represent the entire Device Marking for that device.

(6) Lead finish/Ball material - Orderable Devices may have multiple material finish options. Finish options are separated by a vertical ruled line. Lead finish/Ball material values may wrap to two lines if the finish value exceeds the maximum column width.

**Important Information and Disclaimer:**The information provided on this page represents TI's knowledge and belief as of the date that it is provided. TI bases its knowledge and belief on information provided by third parties, and makes no representation or warranty as to the accuracy of such information. Efforts are underway to better integrate information from third parties. TI has taken and continues to take reasonable steps to provide representative and accurate information but may not have conducted destructive testing or chemical analysis on incoming materials and chemicals. TI and TI suppliers consider certain information to be proprietary, and thus CAS numbers and other limited information may not be available for release.

In no event shall TI's liability arising out of such information exceed the total purchase price of the TI part(s) at issue in this document sold by TI to Customer on an annual basis.

**OTHER QUALIFIED VERSIONS OF TLV2432-Q1, TLV2432A-Q1, TLV2434A-Q1 :**

- Catalog : [TLV2432](#), [TLV2432A](#), [TLV2434A](#)

**NOTE: Qualified Version Definitions:**

- Catalog - TI's standard catalog product

**TAPE AND REEL INFORMATION**

**QUADRANT ASSIGNMENTS FOR PIN 1 ORIENTATION IN TAPE**

\*All dimensions are nominal

| Device         | Package Type | Package Drawing | Pins | SPQ  | Reel Diameter (mm) | Reel Width W1 (mm) | A0 (mm) | B0 (mm) | K0 (mm) | P1 (mm) | W (mm) | Pin1 Quadrant |
|----------------|--------------|-----------------|------|------|--------------------|--------------------|---------|---------|---------|---------|--------|---------------|
| TLV2434AQPWRQ1 | TSSOP        | PW              | 14   | 2000 | 330.0              | 12.4               | 6.9     | 5.6     | 1.6     | 8.0     | 12.0   | Q1            |

**TAPE AND REEL BOX DIMENSIONS**

\*All dimensions are nominal

| Device         | Package Type | Package Drawing | Pins | SPQ  | Length (mm) | Width (mm) | Height (mm) |
|----------------|--------------|-----------------|------|------|-------------|------------|-------------|
| TLV2434AQPWRQ1 | TSSOP        | PW              | 14   | 2000 | 356.0       | 356.0      | 35.0        |

D (R-PDSO-G14)

PLASTIC SMALL OUTLINE



- NOTES:
- A. All linear dimensions are in inches (millimeters).
  - B. This drawing is subject to change without notice.
  - Body length does not include mold flash, protrusions, or gate burrs. Mold flash, protrusions, or gate burrs shall not exceed 0.006 (0,15) each side.
  - Body width does not include interlead flash. Interlead flash shall not exceed 0.017 (0,43) each side.
  - E. Reference JEDEC MS-012 variation AB.

PW (R-PDSO-G14)

PLASTIC SMALL OUTLINE

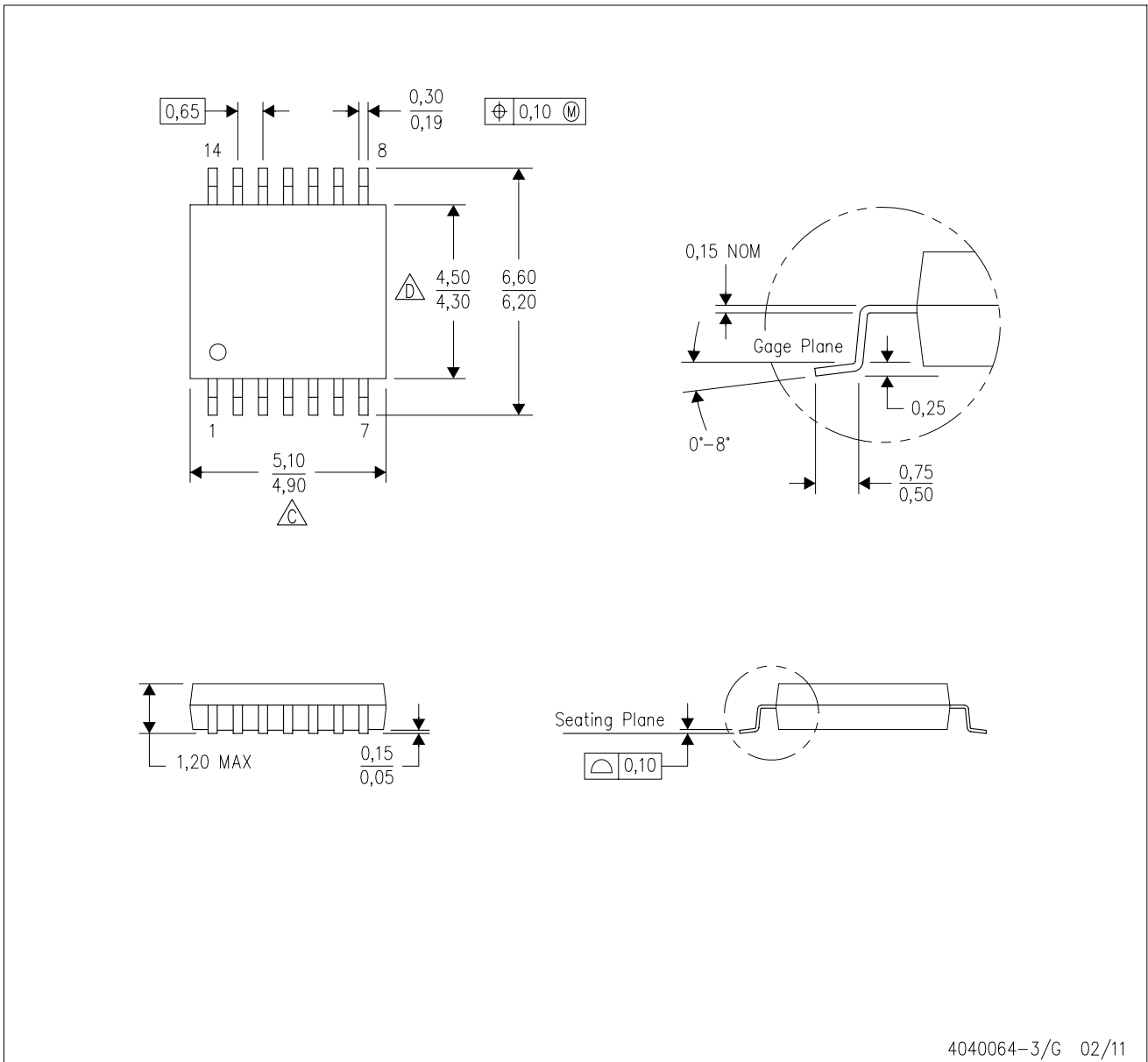

4040064-3/G 02/11

- NOTES:
- A. All linear dimensions are in millimeters. Dimensioning and tolerancing per ASME Y14.5M-1994.
  - B. This drawing is subject to change without notice.
  - Body length does not include mold flash, protrusions, or gate burrs. Mold flash, protrusions, or gate burrs shall not exceed 0,15 each side.
  - Body width does not include interlead flash. Interlead flash shall not exceed 0,25 each side.
  - E. Falls within JEDEC MO-153

PW (R-PDSO-G14)

PLASTIC SMALL OUTLINE



- NOTES:
- All linear dimensions are in millimeters.
  - This drawing is subject to change without notice.
  - Publication IPC-7351 is recommended for alternate designs.
  - Laser cutting apertures with trapezoidal walls and also rounding corners will offer better paste release. Customers should contact their board assembly site for stencil design recommendations. Refer to IPC-7525 for other stencil recommendations.
  - Customers should contact their board fabrication site for solder mask tolerances between and around signal pads.



D0008A

# PACKAGE OUTLINE

SOIC - 1.75 mm max height

SMALL OUTLINE INTEGRATED CIRCUIT



NOTES:

1. Linear dimensions are in inches [millimeters]. Dimensions in parenthesis are for reference only. Controlling dimensions are in inches. Dimensioning and tolerancing per ASME Y14.5M.
2. This drawing is subject to change without notice.
3. This dimension does not include mold flash, protrusions, or gate burrs. Mold flash, protrusions, or gate burrs shall not exceed .006 [0.15] per side.
4. This dimension does not include interlead flash.
5. Reference JEDEC registration MS-012, variation AA.



# EXAMPLE BOARD LAYOUT

D0008A

SOIC - 1.75 mm max height

SMALL OUTLINE INTEGRATED CIRCUIT



LAND PATTERN EXAMPLE  
EXPOSED METAL SHOWN  
SCALE:8X



SOLDER MASK DETAILS

4214825/C 02/2019

NOTES: (continued)

- 6. Publication IPC-7351 may have alternate designs.
- 7. Solder mask tolerances between and around signal pads can vary based on board fabrication site.

# EXAMPLE STENCIL DESIGN

D0008A

SOIC - 1.75 mm max height

SMALL OUTLINE INTEGRATED CIRCUIT



SOLDER PASTE EXAMPLE  
BASED ON .005 INCH [0.125 MM] THICK STENCIL  
SCALE:8X

4214825/C 02/2019

NOTES: (continued)

8. Laser cutting apertures with trapezoidal walls and rounded corners may offer better paste release. IPC-7525 may have alternate design recommendations.
9. Board assembly site may have different recommendations for stencil design.

## IMPORTANT NOTICE AND DISCLAIMER

TI PROVIDES TECHNICAL AND RELIABILITY DATA (INCLUDING DATA SHEETS), DESIGN RESOURCES (INCLUDING REFERENCE DESIGNS), APPLICATION OR OTHER DESIGN ADVICE, WEB TOOLS, SAFETY INFORMATION, AND OTHER RESOURCES "AS IS" AND WITH ALL FAULTS, AND DISCLAIMS ALL WARRANTIES, EXPRESS AND IMPLIED, INCLUDING WITHOUT LIMITATION ANY IMPLIED WARRANTIES OF MERCHANTABILITY, FITNESS FOR A PARTICULAR PURPOSE OR NON-INFRINGEMENT OF THIRD PARTY INTELLECTUAL PROPERTY RIGHTS.

These resources are intended for skilled developers designing with TI products. You are solely responsible for (1) selecting the appropriate TI products for your application, (2) designing, validating and testing your application, and (3) ensuring your application meets applicable standards, and any other safety, security, regulatory or other requirements.

These resources are subject to change without notice. TI grants you permission to use these resources only for development of an application that uses the TI products described in the resource. Other reproduction and display of these resources is prohibited. No license is granted to any other TI intellectual property right or to any third party intellectual property right. TI disclaims responsibility for, and you will fully indemnify TI and its representatives against, any claims, damages, costs, losses, and liabilities arising out of your use of these resources.

TI's products are provided subject to [TI's Terms of Sale](#) or other applicable terms available either on [ti.com](https://www.ti.com) or provided in conjunction with such TI products. TI's provision of these resources does not expand or otherwise alter TI's applicable warranties or warranty disclaimers for TI products.

TI objects to and rejects any additional or different terms you may have proposed.

Mailing Address: Texas Instruments, Post Office Box 655303, Dallas, Texas 75265  
Copyright © 2023, Texas Instruments Incorporated