

MDT1010GIHR-HDMI	1280 x 800	HDMI Interface	TFT Module
(MCT101HDMI-A-RTP) Specification			
Version: 1		Date: 28/06/2019	
Revision			
1	26/06/2019	First issue	

Display Features		
Display Size	10.10"	
Resolution	1280 x 800	
Orientation	Landscape	
Appearance	RGB	
Logic Voltage	5V	
Interface	HDMI	
Brightness	750 cd/m ²	
Touchscreen	RTP	
Module Size	230.56 x 155.01 x 28.40mm	
Operating Temperature	-20°C ~ +70°C	
Pinout	40 Way Connector	
Pitch	---	Weight / Display

* - For full design functionality, please use this specification in conjunction with the TFP401 specification. (Provided Separately)

Display Accessories	
Part Number	Description
MCIB-HDMI/HDMI	HDMI-to-HDMI interconnect board.
MCIC-USB	Type-A USB to Micro-B USB interconnect cable.

Optional Variants	
Appearances	Voltage
Capacitive Touch Panel No Touch Panel	



Summary

TFT 10.1" is a IPS transmissive type color active matrix TFT liquid crystal display . In-Plane Switching (IPS) was one of the first refinements to produce significant gains in the light-transmissive characteristics of TFT panels. It is a technology that addresses the two main issues of a standard twisted nematic (TN) TFT display: colour and viewing angle.

General Specifications

- Screen Diagonal: 10.1
- Number of Pixels: 1280 x 3(RGB) x 800
- Module dimension: 230.56 x 155.01 x 28.4(max)
- Active area: 216.96 (H) x 135.6(V)
- Pixel pitch: 0.1695 × 0.1695
- Display Mode: Normally Black
- Pixel Arrangement: R.G.B. Vertical Stripe
- Backlight Type: LED, Normally White
- Aspect Ratio: 16:9
- Electrical Interface (Logic): HDMI
- RTP Interface: USB
- With /Without TP: With RTP
- Surface: Anti-Glare

*Color tone slight changed by temperature and driving voltage.



Interface

CON6

Pin No.	Symbol	Function	Remark
1	3.3V	TFT Module Power limit can only output 3.3V,100mA	Note1
2	5V	Raspberry Pi:Power 5V	
3	GPIO02	Raspberry Pi:GPIO02	
4	5V	Raspberry Pi:Power 5V	
5	GPIO03	Raspberry Pi:GPIO03	
6	GND	Raspberry Pi:GND	
7	GPIO04	Raspberry Pi:GPIO04	
8	GPIO14	Raspberry Pi:GPIO14	
9	GND	Raspberry Pi:GND	
10	GPIO15	Raspberry Pi:GPIO15	
11	GPIO17	Raspberry Pi:GPIO17	
12	GPIO18	Raspberry Pi:GPIO18 (Backlight Enable)	
13	GPIO27	Raspberry Pi:GPIO27	
14	GND	Raspberry Pi:GND	
15	GPIO22	Raspberry Pi:GPIO22	
16	GPIO23	Raspberry Pi:GPIO23	
17	3.3V	TFT Module Power limit can only output 3.3V,100mA	Note1
18	GPIO24	Raspberry Pi:GPIO24	
19	GPIO10	Raspberry Pi:GPIO10	
20	GND	Raspberry Pi:GND	
21	GPIO09	Raspberry Pi:GPIO09	
22	GPIO25	Raspberry Pi:GPIO25	
23	GPIO11	Raspberry Pi:GPIO11	
24	GPIO08	Raspberry Pi:GPIO08	
25	GND	Raspberry Pi:GND	
26	GPIO07	Raspberry Pi:GPIO07	
27	ID_SD	Raspberry Pi:ID_SD	
28	ID_SC	Raspberry Pi:ID_SC	
29	GPIO05	Raspberry Pi:GPIO05	
30	GND	Raspberry Pi:GND	
31	GPIO06	Raspberry Pi:GPIO06	
32	GPIO12	Raspberry Pi:GPIO12	



33	GPIO13	Raspberry Pi:GPIO13	
34	GND	Raspberry Pi:GND	
35	GPIO19	Raspberry Pi:GPIO19	
36	GPIO16	Raspberry Pi:GPIO16	
37	GPIO26	Raspberry Pi:GPIO26	
38	GPIO20	Raspberry Pi:GPIO20	
39	GND	Raspberry Pi:GND	
40	GPIO21	Raspberry Pi:GPIO21	

Note1: The 3.3V supply current is limited; please pay special attention to use



CON5

Pin No.	Symbol	Function	Remark
1	NC	No connection	
2	5V	Raspberry Pi:Power 5V	
3	GPIO02	Raspberry Pi:GPIO02	
4	5V	Raspberry Pi:Power 5V	
5	GPIO03	Raspberry Pi:GPIO03	
6	GND	Raspberry Pi:GND	
7	GPIO04	Raspberry Pi:GPIO04	
8	GPIO14	Raspberry Pi:GPIO14	
9	GND	Raspberry Pi:GND	
10	GPIO15	Raspberry Pi:GPIO15	
11	GPIO17	Raspberry Pi:GPIO17	
12	GPIO18	Raspberry Pi:GPIO18 (Backlight Enable)	
13	GPIO27	Raspberry Pi:GPIO27	
14	GND	Raspberry Pi:GND	
15	GPIO22	Raspberry Pi:GPIO22	
16	GPIO23	Raspberry Pi:GPIO23	
17	NC	No connection	
18	GPIO24	Raspberry Pi:GPIO24	
19	GPIO10	Raspberry Pi:GPIO10	
20	GND	Raspberry Pi:GND	
21	GPIO09	Raspberry Pi:GPIO09	
22	GPIO25	Raspberry Pi:GPIO25	
23	GPIO11	Raspberry Pi:GPIO11	
24	GPIO08	Raspberry Pi:GPIO08	
25	GND	Raspberry Pi:GND	
26	GPIO07	Raspberry Pi:GPIO07	
27	ID_SD	Raspberry Pi:ID_SD	
28	ID_SC	Raspberry Pi:ID_SC	
29	GPIO05	Raspberry Pi:GPIO05	
30	GND	Raspberry Pi:GND	
31	GPIO06	Raspberry Pi:GPIO06	
32	GPIO12	Raspberry Pi:GPIO12	
33	GPIO13	Raspberry Pi:GPIO13	



34	GND	Raspberry Pi:GND	
35	GPIO19	Raspberry Pi:GPIO19	
36	GPIO16	Raspberry Pi:GPIO16	
37	GPIO26	Raspberry Pi:GPIO26	
38	GPIO20	Raspberry Pi:GPIO20	
39	GND	Raspberry Pi:GND	
40	GPIO21	Raspberry Pi:GPIO21	

HDMI

Pin No.	Symbol	I/O	Function	Remark
1	Rx2+	I	+LVDS Differential Data Input	
2	GND	P	Ground	
3	Rx2-	I	-LVDS Differential Data Input	
4	Rx1+	I	+LVDS Differential Data Input	
5	GND	P	Ground	
6	Rx1-	I	-LVDS Differential Data Input	
7	Rx0+	I	+LVDS Differential Data Input	
8	GND	P	Ground	
9	Rx0-	I	-LVDS Differential Data Input	
10	RxC+	I	+LVDS Differential Clock Input	
11	GND	P	Ground	
12	RxC-	I	-LVDS Differential Clock Input	
13-14	NC	-	No connection	
15	SCL	I/O	DDC(Data Display Channel) Clock	
16	SDA	I/O	DDC(Data Display Channel) Data	
17	GND	P	Ground	
18	5V	P	Power Supply	
19	Detect	I/O	Hot plug detect	

I: input, O: output, P: Power



POWER-JACK

Pin No.	Symbol	I/O	Function	Remark
1	5V	P	Power Supply (5V)	
2	GND	P	Ground	
3	NC	-	No connection	

USB

Pin	Symbol	Function	Remark
1	5V	Power Supply (5V)	
2	D-	Data line -	
3	D+	Data line +	
4	NC	No connection	
5	GND	Power Ground	

MIDAS

design • manufacture • supply



Contour Drawing

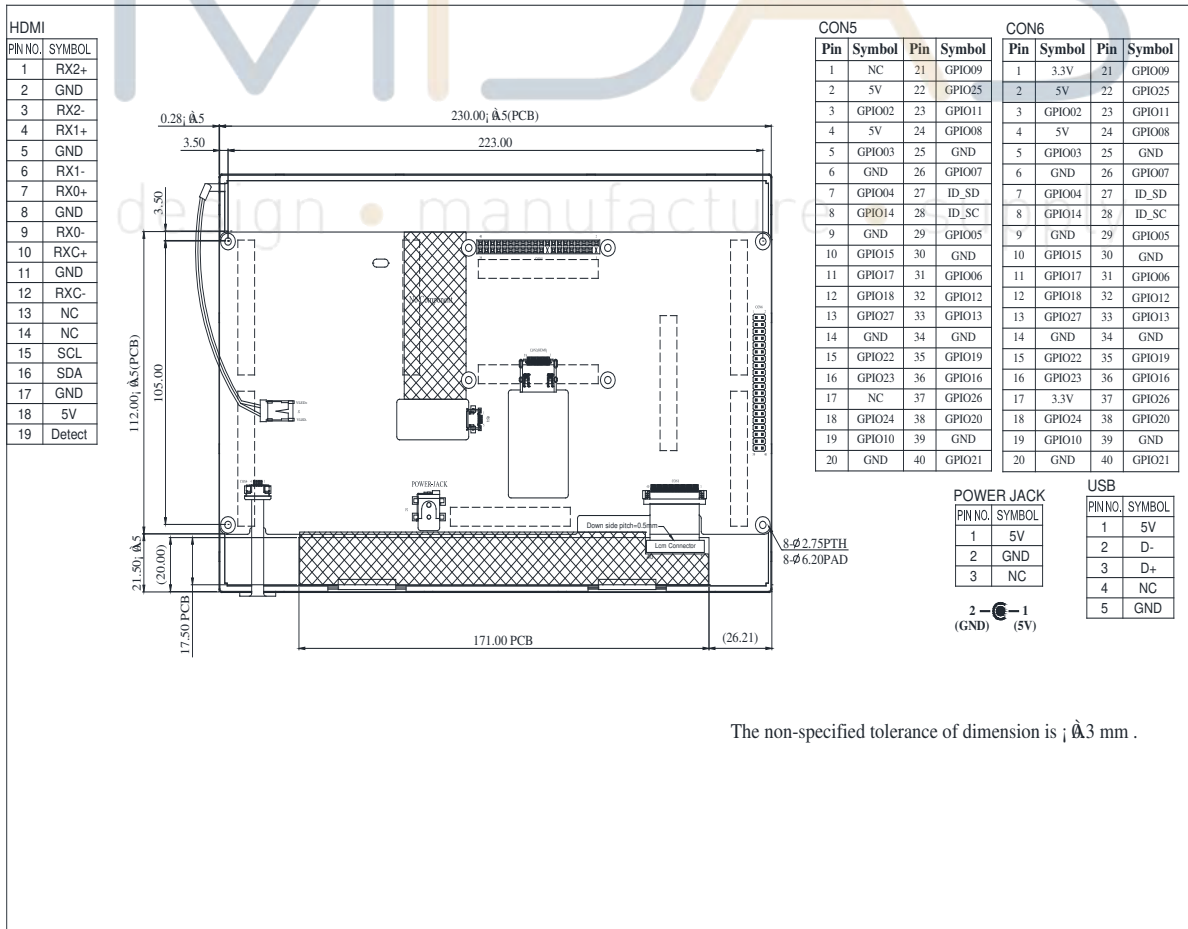
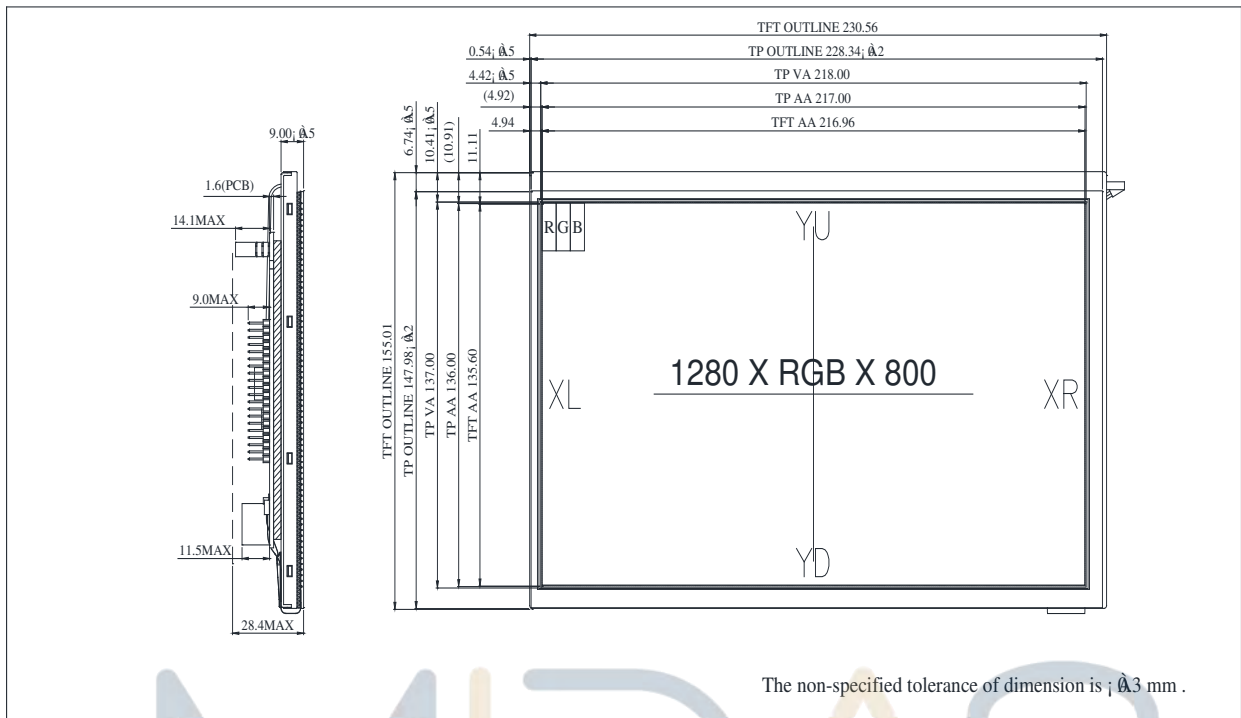

Absolute Maximum Ratings

Item	Symbol	Min	Typ	Max	Unit
Operating Temperature	TOP	-20	—	+70	°C
Storage Temperature	TST	-20	—	+70	°C

Note: Device is subject to be damaged permanently if stresses beyond those absolute maximum ratings listed above

1. Temp. $\leq 60^{\circ}\text{C}$, 90% RH MAX. Temp. $> 60^{\circ}\text{C}$, Absolute humidity shall be less than 90% RH at 60°C

Electrical Characteristics

Operating conditions:

Item	Symbol	Condition	Min	Typ	Max	Unit	Remark
Supply Voltage For LCM	VDD	—	4.9	5	5.1	V	—
Supply Current For LCM	IDD	—	—	1.9	2.7	A	Note 1
LED life time	—	—	50000	—	—	Hr	Note 4

Note 1 : This value is test for VDD =5.0V , Ta=25°C only

Note 2 : Display with Raspberry pi the driver power is over USB , first make sure you have a 3A power supply, with a good quality USB cable, a thin wire power cable is no good. Make sure its 24AWG or smaller, shorter USB cables are better too.

Note3 : Touch Panel driver is base on the mouse driver program and through USB port connect to PC or embedded board.Can only support the single touch.

Note 4: The “LED life time” is defined as the module brightness decrease to 50% original brightness at Ta=25°C and IL =480mA. The LED lifetime could be decreased if operating IL is lager than 480mA.



LVDS Signal Timing Characteristics

AC Electrical Characteristics

Parameter	Symbol	Values			Unit	Remark
		Min.	Typ.	MAX.		
LVDS Differential input high Threshold voltage	RxVTH	-	-	+100	mV	RXVCM=1.2 V
LVDS Differential input low Threshold voltage	RxVTL	-100	-	-	mV	
LVDS Differential input common mode voltage	RxVCM	0.7	-	1.6	V	
LVDS Differential voltage	VID	200	-	600	mV	

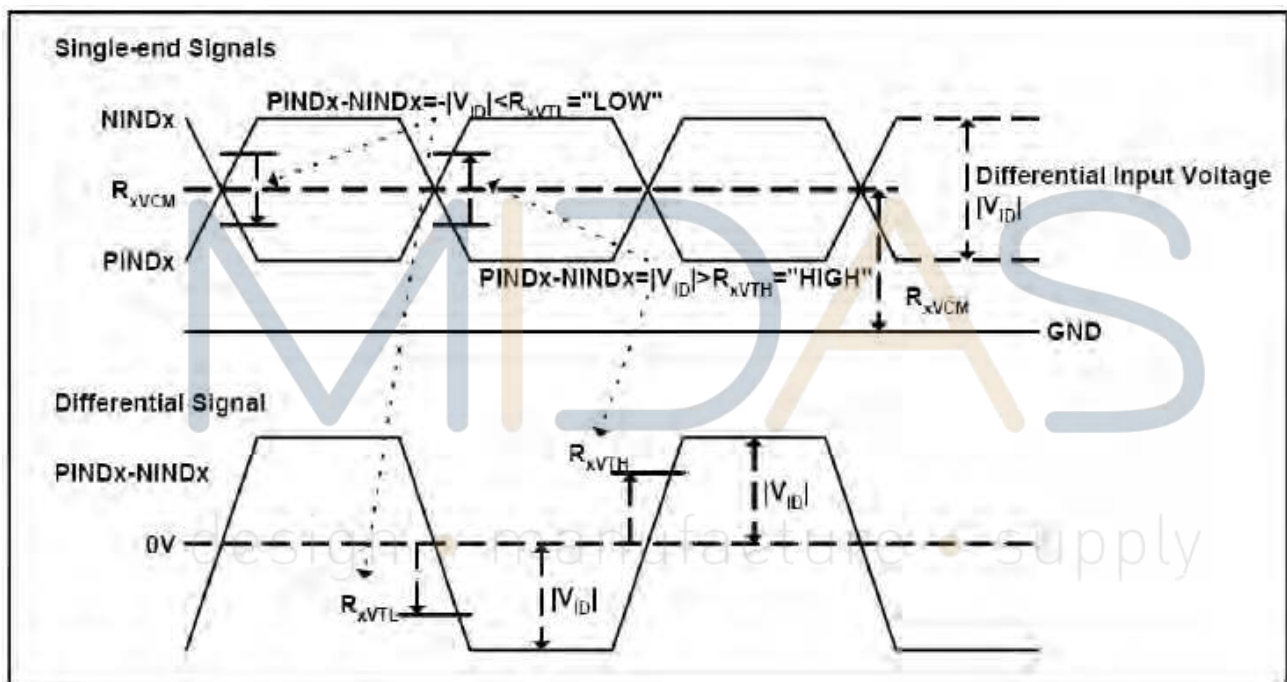

Timing Table

Parameter	Symbol	Value			Unit	Remark
		Min.	Typ.	Max.		
Clock Frequency	1/Tc	68.9	71.1	73.4	Mhz	Frame rate =60Hz
Horizontal display area	thd	1280			Tc	
HS period time	th	1410	1440	1470	Tc	
HS Width +Back Porch +Front Porch	tHW+ tHBP +tHFP	60	160	190	Tc	
Vertical display area	tvd	800			tH	
VS period time	tv	815	823	833	tH	
VS Width +Back Porch +Front Porch	tvW+ tvBP +tvFP	15	23	33	tH	

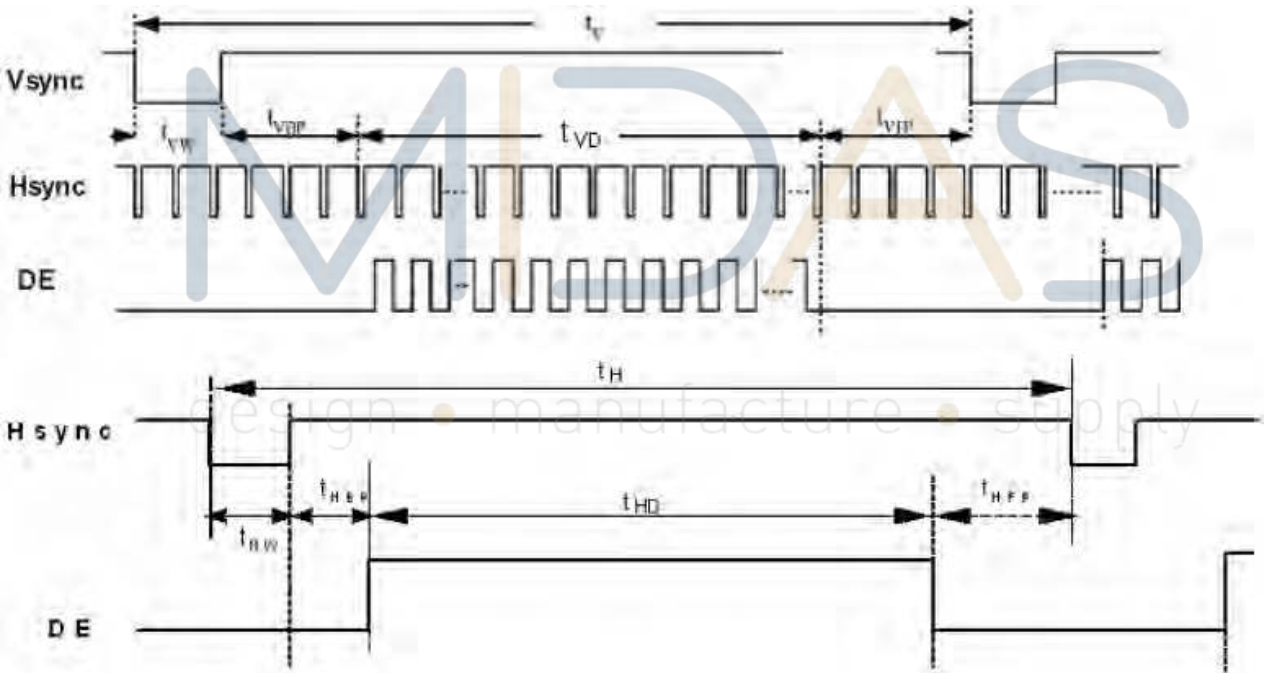

LVDS Data Input Format

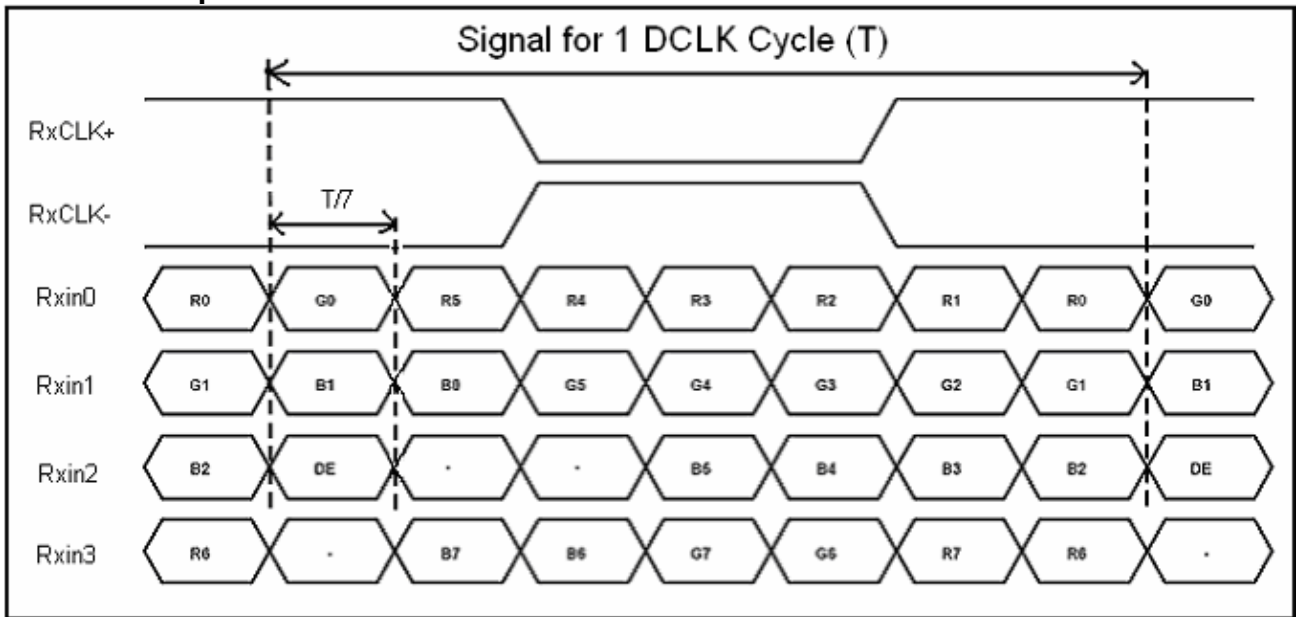

MIDAS

design • manufacture • supply



Optical Characteristics

Item	Symbol	Condition.	Min	Typ.	Max.	Unit	Remark	
Response time	Tr	$\theta=0^\circ$ 、 $\Phi=0^\circ$	-	10	20	.ms	Note 3	
	Tf		-	15	30			
Contrast ratio	CR	At optimized viewing angle	600	800	-	-	Note 4	
Color Chromaticity	White	Wx	$\theta=0^\circ$ 、 $\Phi=0$	0.26	0.31	0.36	-	Note 2,6,7
		Wy		0.28	0.33	0.38	-	
Viewing angle	Hor.	Θ_R	$CR \geq 10$	75	85	-	Deg.	Note 1
		Θ_L		75	85	-		
	Ver.	Φ_T		75	85	-		
		Φ_B		75	85	-		
Brightness	-	-	700	750	-	cd/m ²	Center of display	
Uniformity	(U)	-	70	-	-	%	Note5	

Ta=25±2°C

Note 1: Definition of viewing angle range

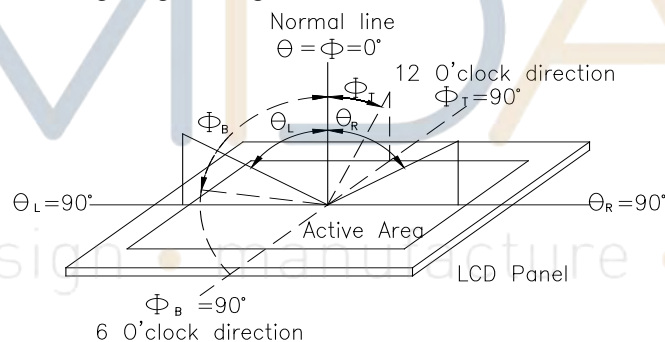

Fig. 9.1. Definition of viewing angle

Note 2: Test equipment setup:

After stabilizing and leaving the panel alone at a driven temperature for 10 minutes, the measurement should be executed. Measurement should be executed in a stable, windless, and dark room. Optical specifications are measured by Topcon BM-7 or BM-5 luminance meter 1.0° field of view at a distance of 50cm and normal direction.



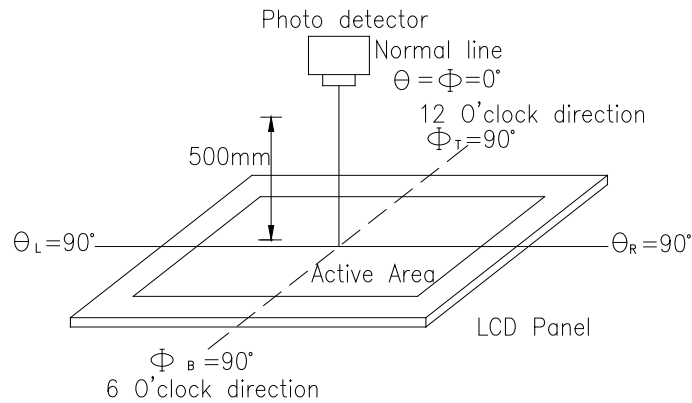
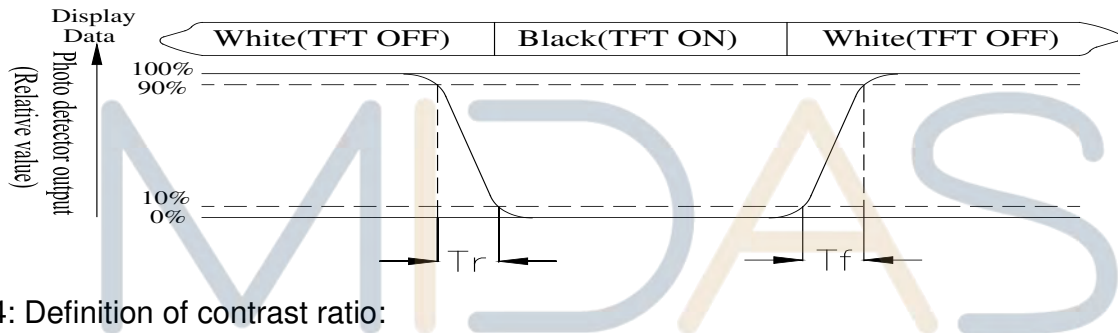

Fig. 9.2. Optical measurement system setup

Note 3: Definition of Response time:

The response time is defined as the LCD optical switching time interval between "White" state and "Black" state. Rise time, T_r , is the time between photo detector output intensity changed from 90% to 10%. And fall time, T_f , is the time between photo detector output intensity changed from 10% to 90%



Note 4: Definition of contrast ratio:

The contrast ratio is defined as the following expression.

$$\text{Contrast ratio (CR)} = \frac{\text{Luminance measured when LCD on the "White" state}}{\text{Luminance measured when LCD on the "Black" state}}$$



Note 5: Definition of Luminance Uniformity

Active area is divided into 9 measuring areas (reference the picture in below). Every measuring point is placed at the center of each measuring area.

Luminance Uniformity (U) = $L_{min}/L_{max} \times 100\%$

L = Active area length

W = Active area width

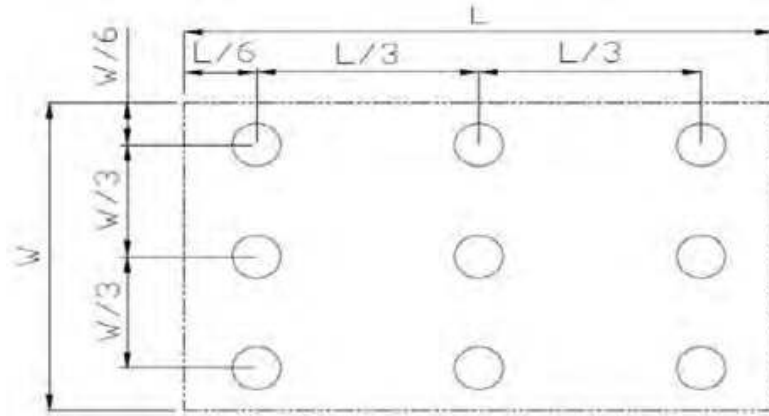

Fig 9.3. Definition of uniformity

Note 6: Definition of color chromaticity (CIE 1931)

Color coordinates measured at the center point of LCD

Note 7: Measured at the center area of the panel when all the input terminals of LCD panel are electrically opened.

MIDAS

design • manufacture • supply



Reliability

Content of Reliability Test (Wide temperature, -20°C~70°C)

Environmental Test			
Test Item	Content of Test	Test Condition	Note
High Temperature storage	Endurance test applying the high storage temperature for a long time.	70°C 200hrs	2
Low Temperature storage	Endurance test applying the low storage temperature for a long time.	-20°C 200hrs	1,2
High Temperature Operation	Endurance test applying the electric stress (Voltage & Current) and the thermal stress to the element for a long time.	70°C 200hrs	—
Low Temperature Operation	Endurance test applying the electric stress under low temperature for a long time.	-20°C 200hrs	1
High Temperature/ Humidity Operation	The module should be allowed to stand at 60°C,90%RH max	60°C,90%RH 96hrs	1,2
Thermal shock resistance	The sample should be allowed stand the following 10 cycles of operation <div style="text-align: center;"> <p>-20°C 25°C 70°C</p> <p>30min 5min 30min</p> <p>1 cycle</p> </div>	-20°C/70°C 10 cycles	—
Vibration test	Endurance test applying the vibration during transportation and using.	Total fixed amplitude : 1.5mm Vibration Frequency : 10~55Hz One cycle 60 seconds to 3 directions of X,Y,Z for Each 15 minutes	3
Static electricity test	Endurance test applying the electric stress to the terminal.	VS=±600V(contact) , ±800v(air), RS=330Ω CS=150pF 10 times	—

Note1: No dew condensation to be observed.

Note2: The function test shall be conducted after 4 hours storage at the normal Temperature and humidity after remove from the test chamber.

Note3: The packing have to including into the vibration testing.



Touch Panel Information

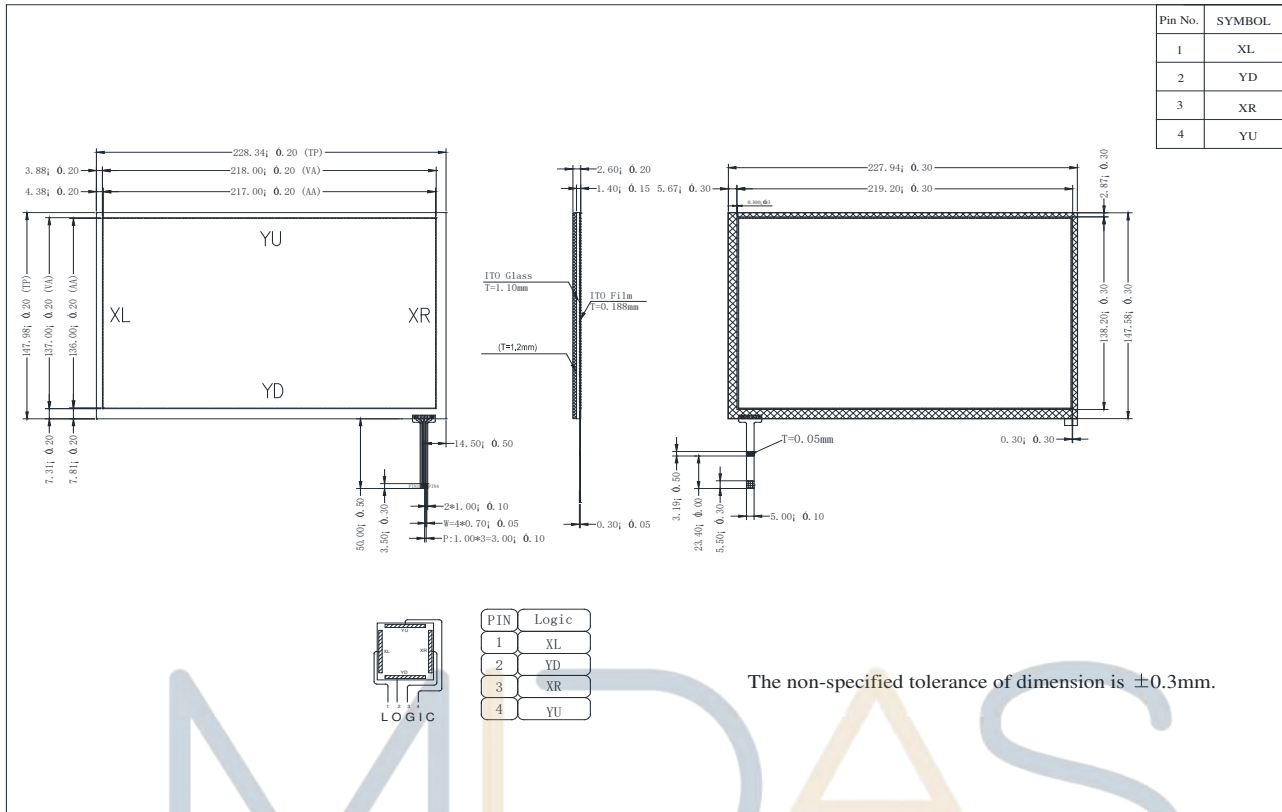

Resistance Touch Panel General Specifications

Item	Description
Driving condition	DC5V
Operating force	20~100g
Linearity max	≤±1.5%
Insulating resistance	>20MΩ · 25V(DC)
Light transpance	70%
Structure type	ITO Film/ITO Glass(F/G)
Surface Hardness	3H typ
Pen Hitting Durability (with the silicon rubber)	> 1000,000 times
X resistance	450~1100Ω
Y resistance	200~600Ω