

Specification

- Part No. : **LWB01.A.505111**
- Product Name : External 4G/LTE Wide Band 689-960/1710-2690MHz
Bracket Mount Dipole Antenna
- Features : Worldwide 4G LTE including 3G and 2G
Product Dimensions: 425.5*45*157mm
External Bracket Mount Antenna
Robust Design for All Weather Operation
Cable: 5M CFD-200
Connector: SMA(M)
Cables and Connectors Customizable
IP67 Rated
RoHS Compliant



1. Introduction

The LWB01 is an omnidirectional, outdoor, 4G LTE antenna for use in worldwide telematics and cellular communication. Its flat and compact blade design provides a wide frequency range, high efficiency and optimum omni-directional gain across all bands.

4G LTE applications demand a high-speed data uplink and downlink. The LWB01, utilizing low loss cables, provides high efficiency and high gain to achieve these requirements over long cable lengths.

Typical Applications:

- Global telematics
- Transportation
- Remote monitoring applications.

The heavy-duty, fully IP67 waterproof housing can be used for either outdoor or indoor environments and with the mounting shaft, it can be easily fixed to walls or poles. The antenna casting and the mounting shaft are protected by heat resistant, high impact, UV stabilized material, making it extremely robust.

Cable length and connector types are customizable. Options to use lower loss LMR400 or CFD400 cable are accommodated through the on-board connector in the bracket. Contact your regional Taoglas sales office for support.

2. Specification

Cellular Antenna							
Frequency (MHz)	LTE700	GSM850	GSM900	DCS	PCS	UMTS1	LTE2600
	698~806	824~894	880~960	1710~1880	1850~1990	1920~2170	2300~2690
Efficiency (%)							
LTE_0.3M	44.11	67.07	67.60	62.53	68.28	67.15	41.48
LTE_1.0M	40.81	63.36	62.07	55.18	59.07	57.57	35.41
LTE_2.0M	42.42	60.04	57.07	49.80	53.17	51.94	31.60
LTE_3.0M	33.41	57.39	49.52	45.24	48.21	46.86	28.01
LTE_5.0M	30.45	47.24	42.77	34.21	36.13	34.93	19.77
Average Gain (dBi)							
LTE_0.3M	-3.68	-1.74	-1.72	-2.04	-1.66	-1.74	-4.07
LTE_1.0M	-3.99	-1.99	-2.10	-2.59	-2.29	-2.41	-4.82
LTE_2.0M	-3.80	-2.22	-2.48	-3.04	-2.74	-2.86	-5.33
LTE_3.0M	-4.91	-2.42	-3.12	-3.45	-3.17	-3.31	-5.82
LTE_5.0M	-5.38	-3.26	-3.73	-4.66	-4.42	-4.58	-7.34
Peak Gain (dBi)							
LTE_0.3M	2.57	4.31	4.51	4.38	4.98	5.08	4.10
LTE_1.0M	3.10	4.54	4.78	3.21	3.21	3.37	3.08
LTE_2.0M	2.63	4.50	4.61	2.86	2.87	3.23	3.24
LTE_3.0M	2.59	4.07	4.05	2.42	2.65	2.83	1.79
LTE_5.0M	1.89	2.64	2.40	2.02	1.71	1.29	1.33
Impedance	50Ω						
Polarization	Linear						

MECHANICAL	
Antenna Dimensions	425.5*45*157mm
Cable	5 Meter CFD-200
Connector	SMA(M)
Casing	ASA
Weight	250g
IP Rating	IP67
ENVIRONMENTAL	
Operation Temperature	-40°C to 85°C
Storage Temperature	-40°C to 90°C
Humidity	Non-condensing 65°C 95% RH

3. Antenna Characteristics

3.1. Antenna Test Setup

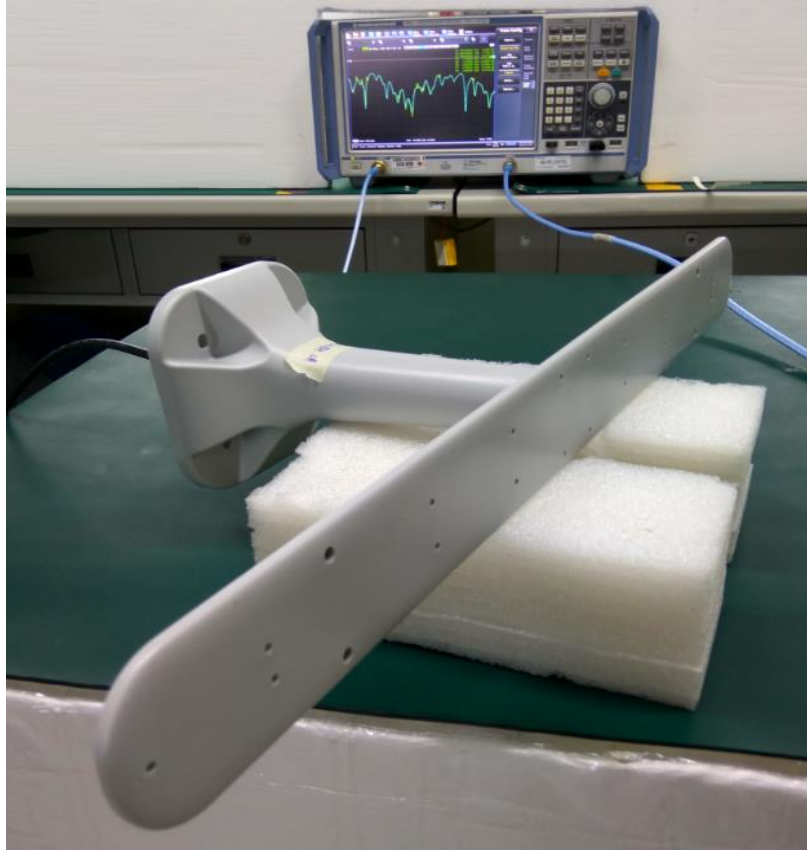

3.2. Return Loss

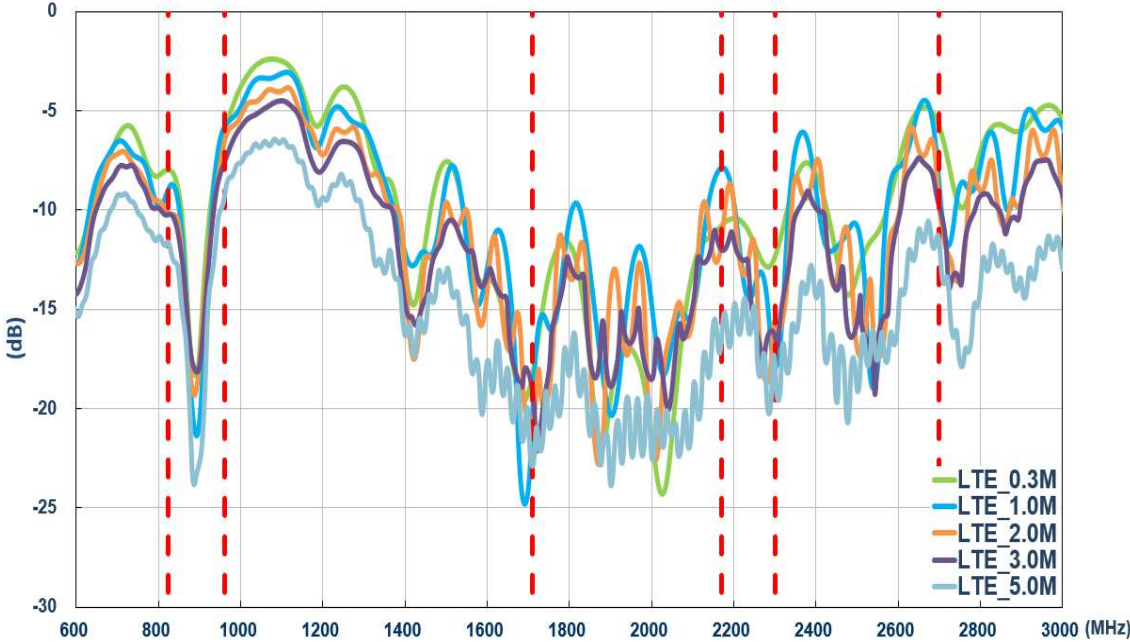

3.3. Efficiency

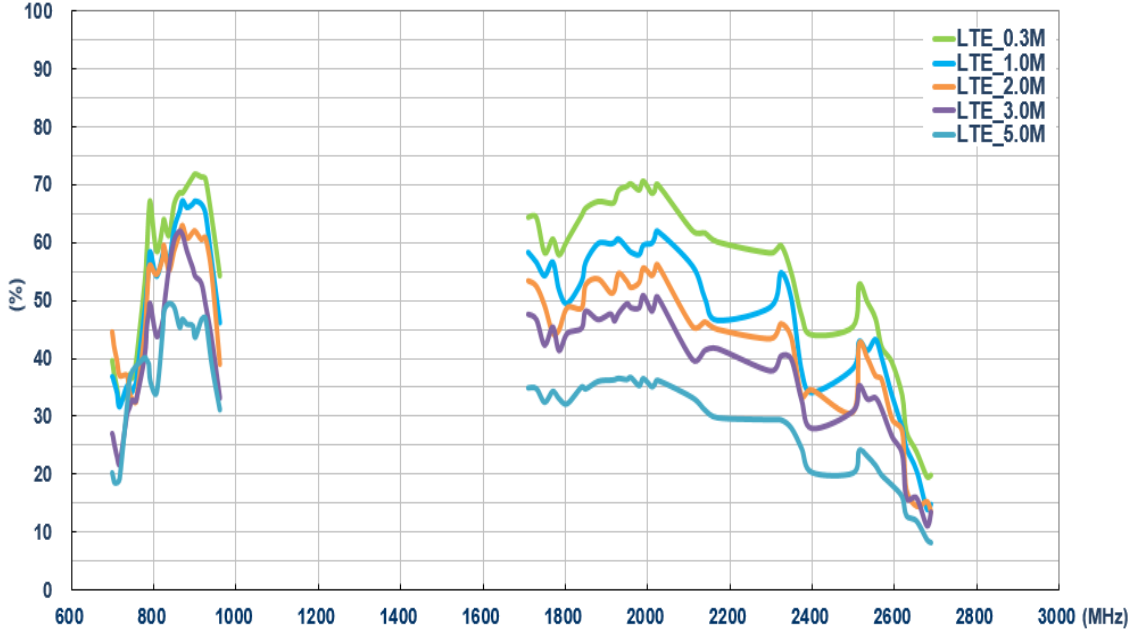

3.4. Average Gain

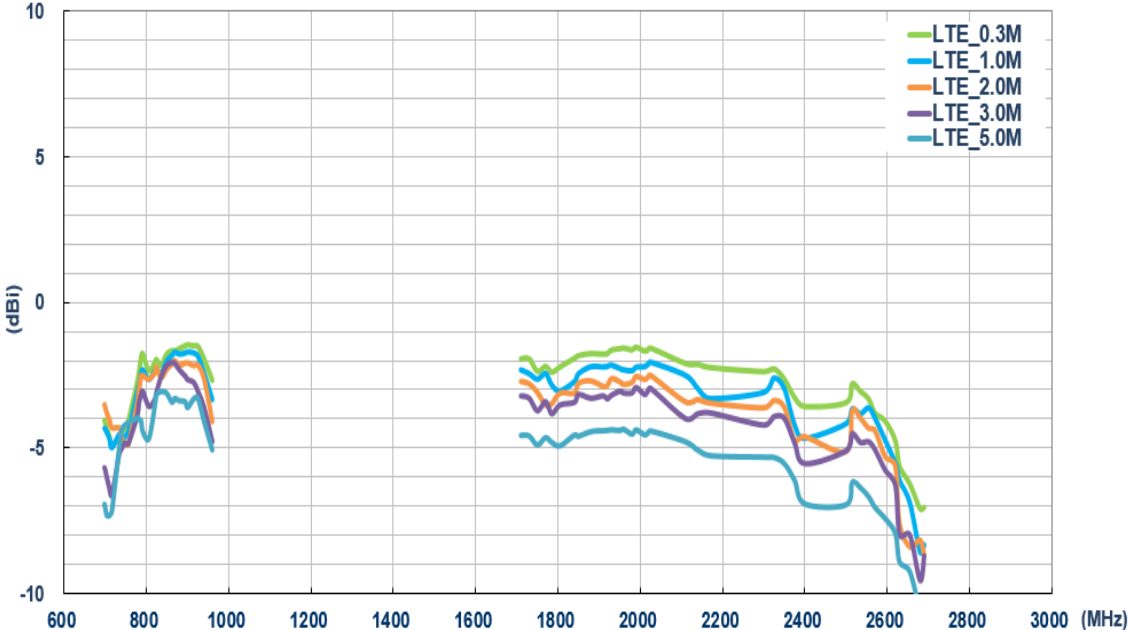

3.5. Peak Gain

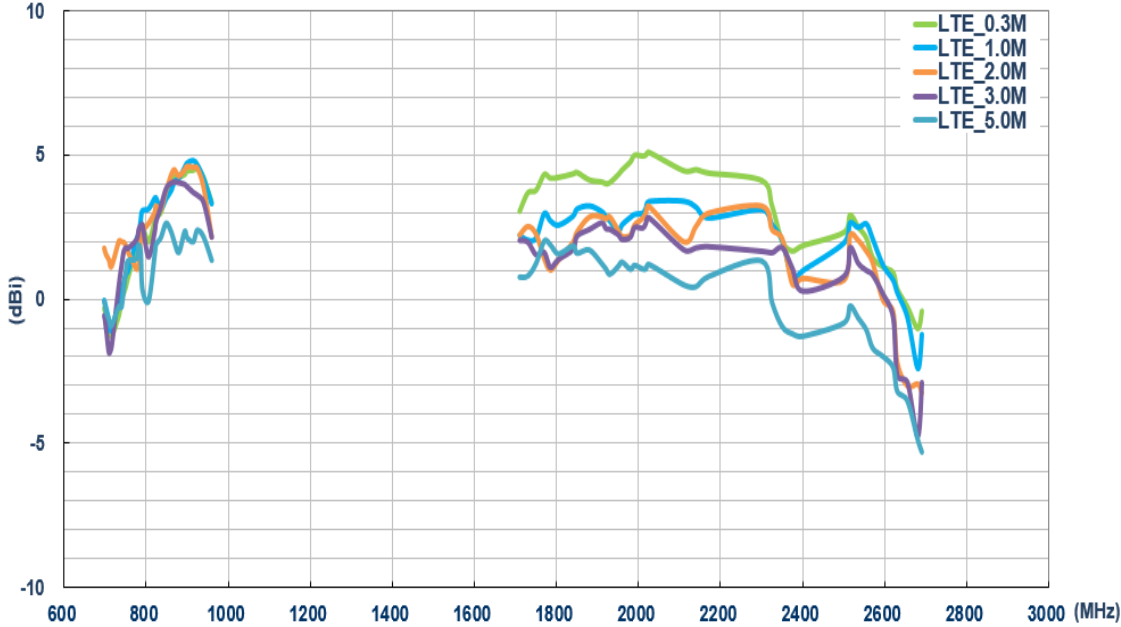

4. Antenna Radiation Patterns

4.1. Antenna Setup (Antenna Test Setup in Anechoic Chamber)

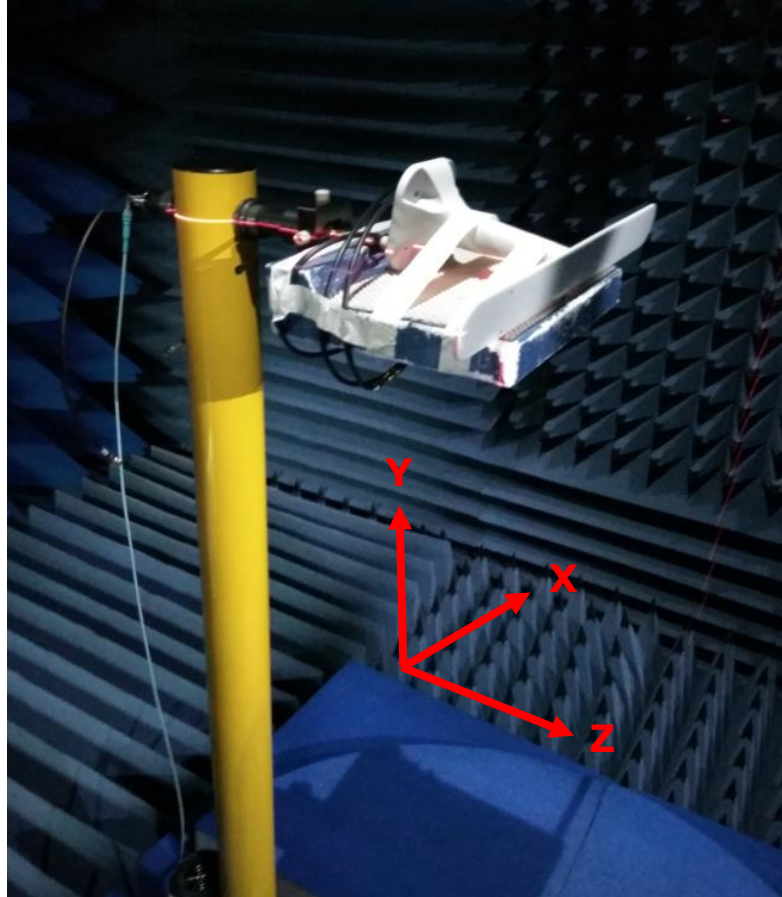

4.2. 2D Radiation Patterns

4.2.1. With 0.3M Cable

XY Plane

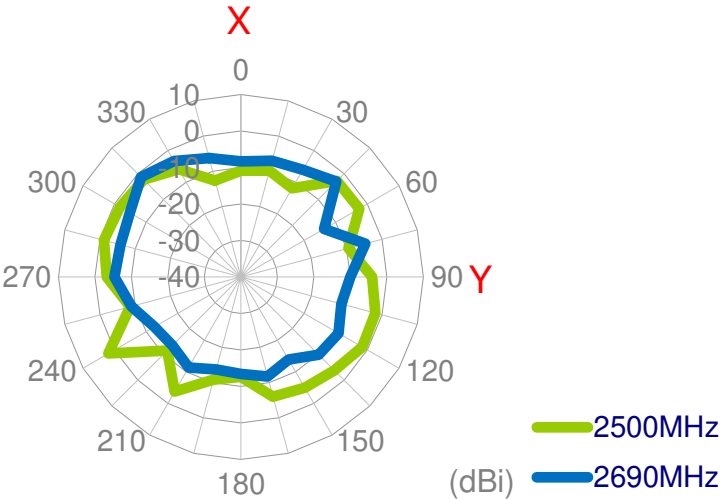
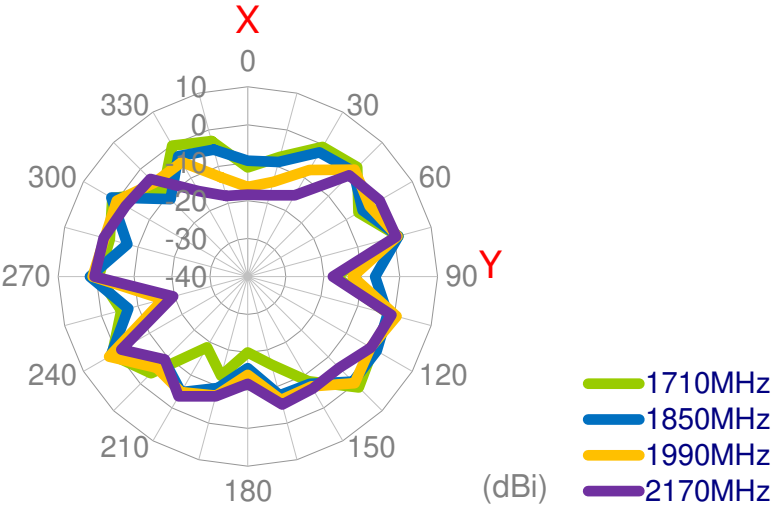
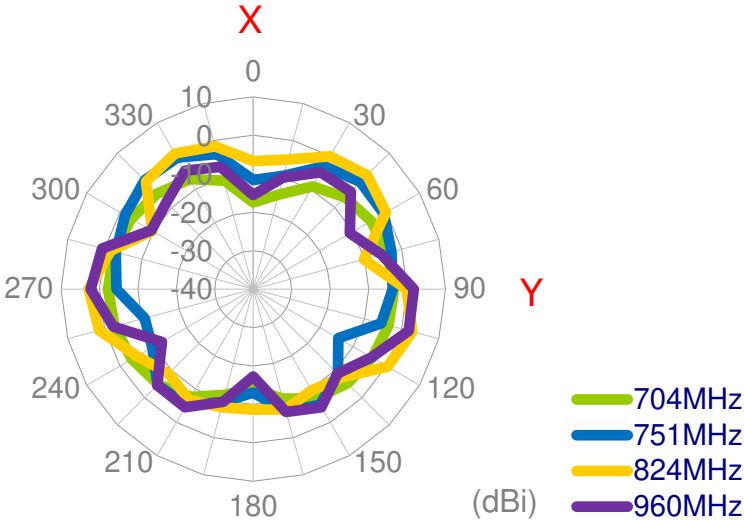



XZ Plane

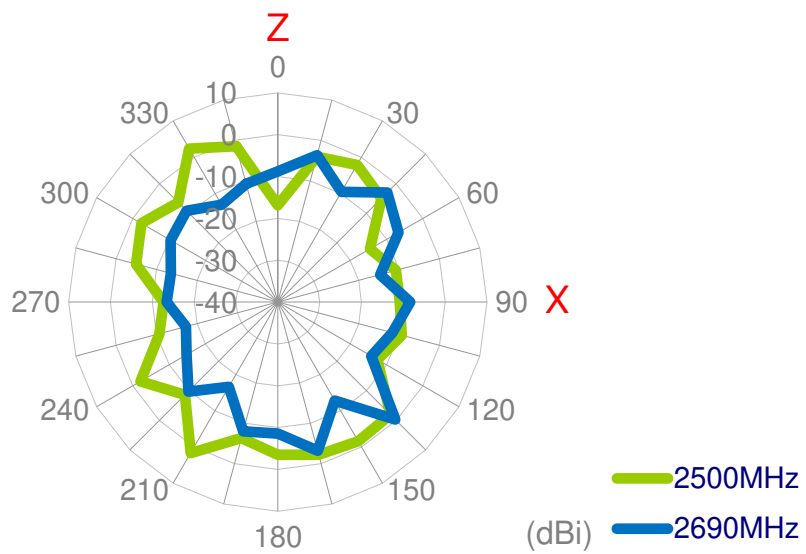
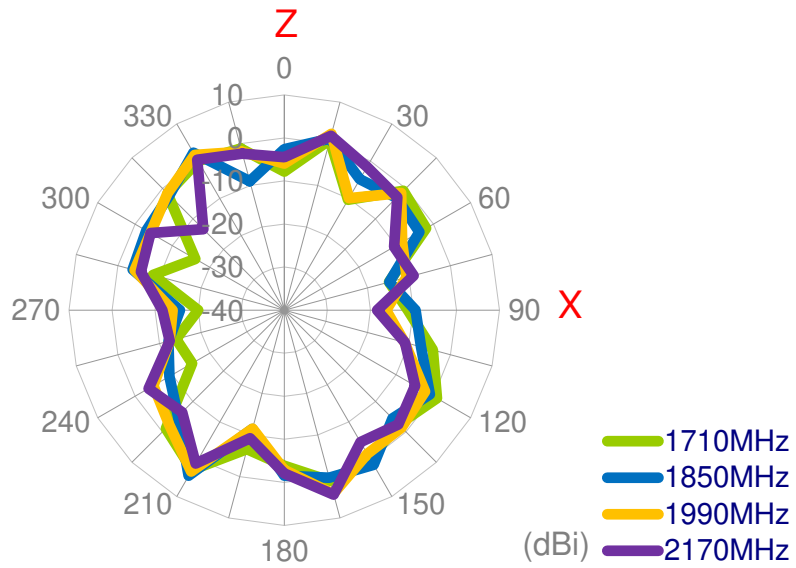
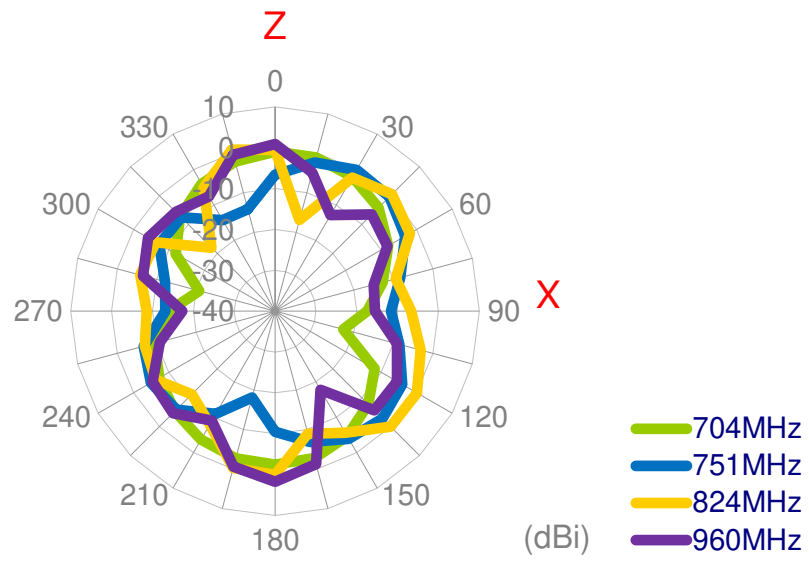



YZ Plane

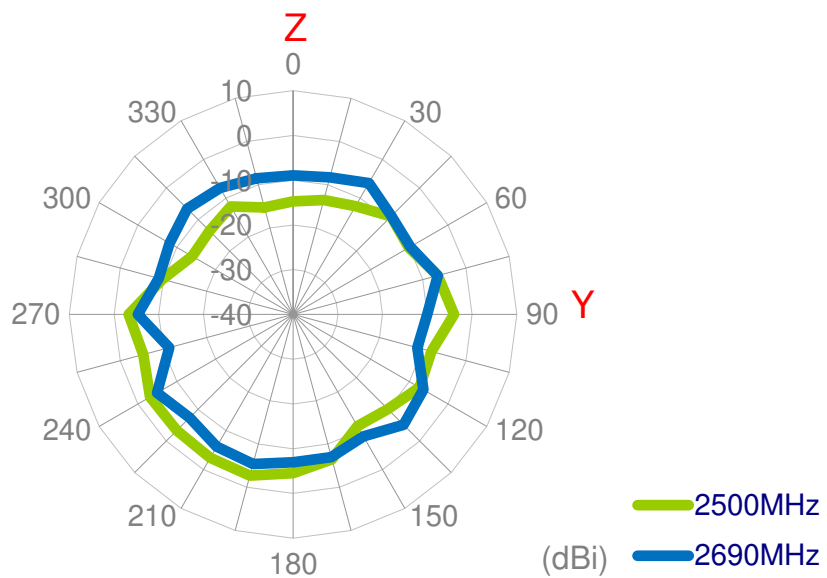
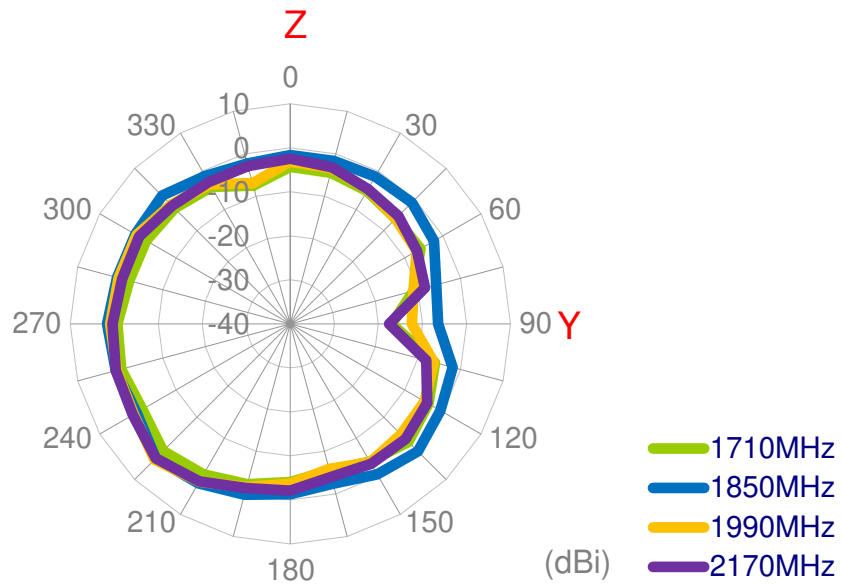
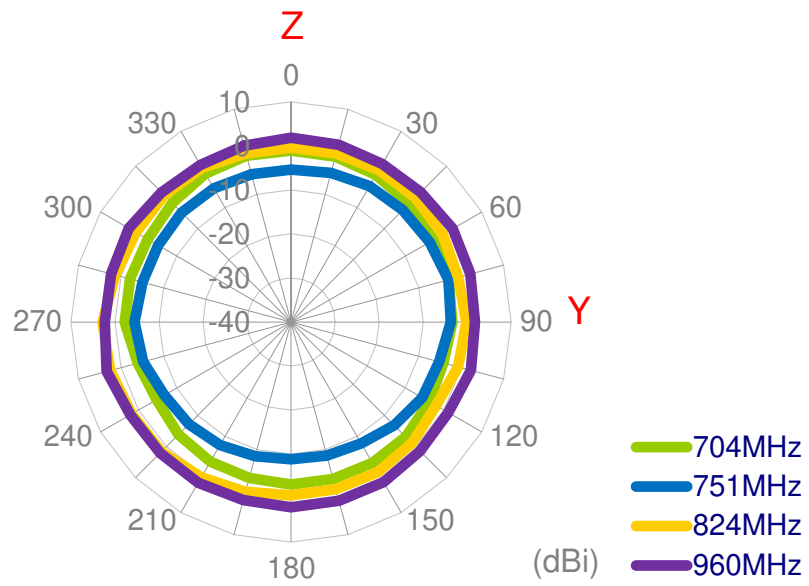

4.3. 3D Radiation Patterns

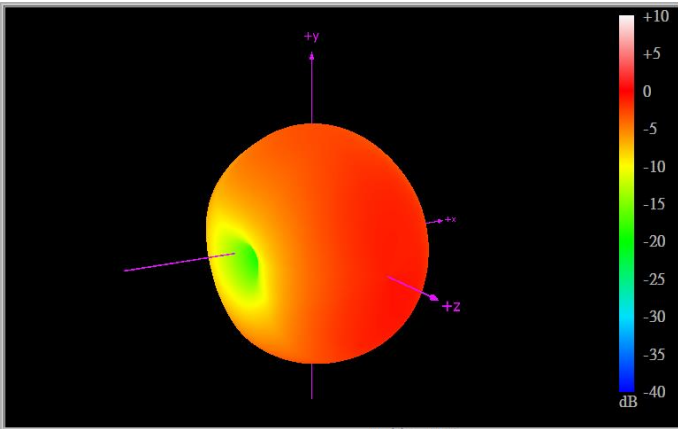

704MHz

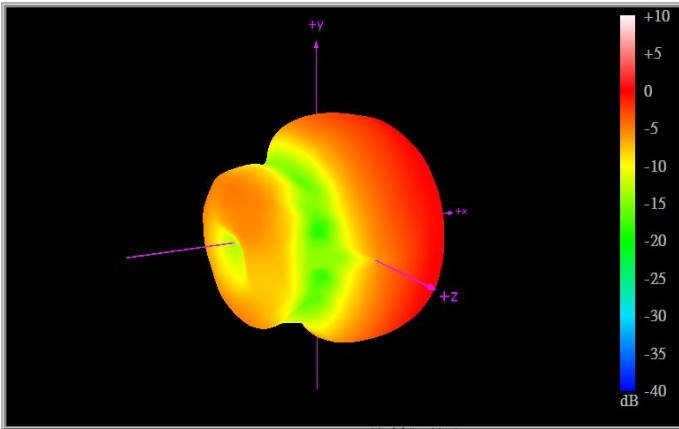

751MHz

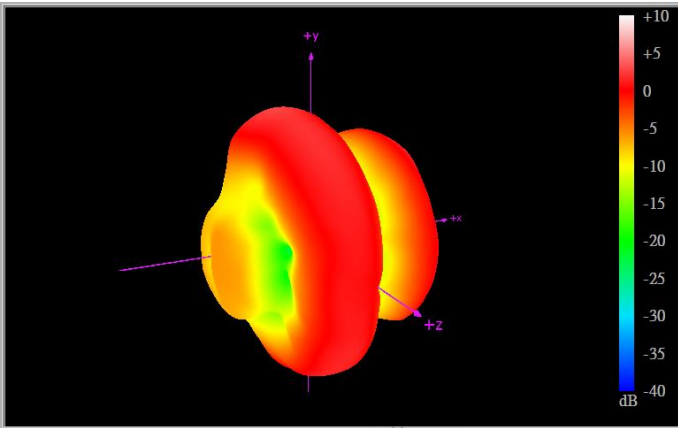

824MHz

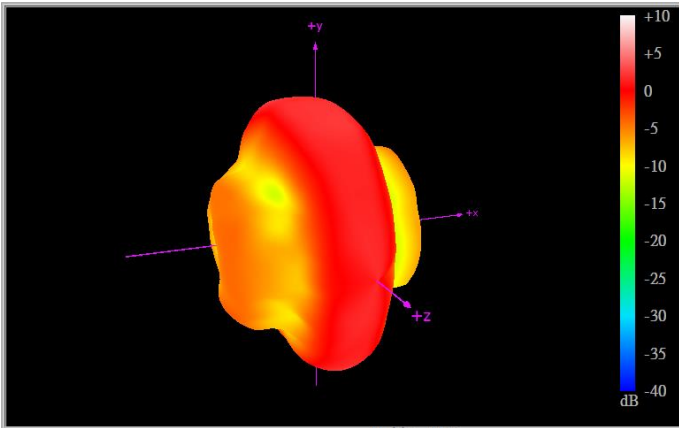

960MHz

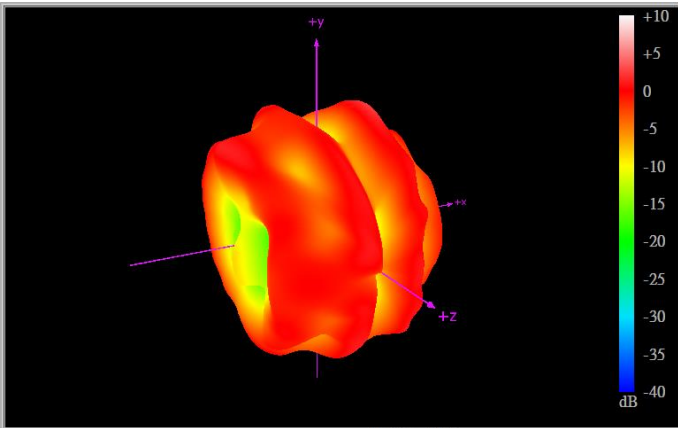

1710MHz

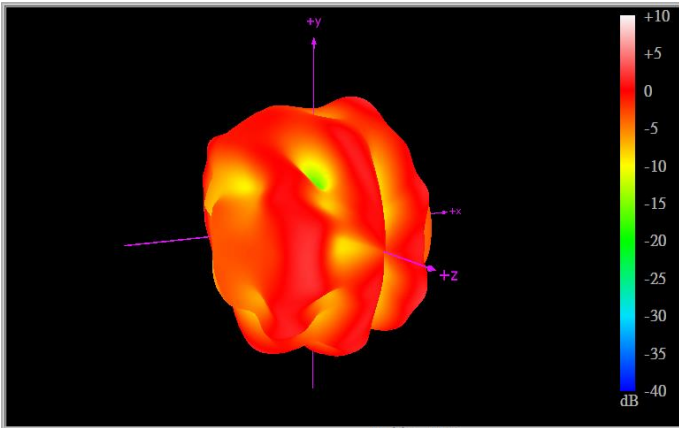

1850MHz

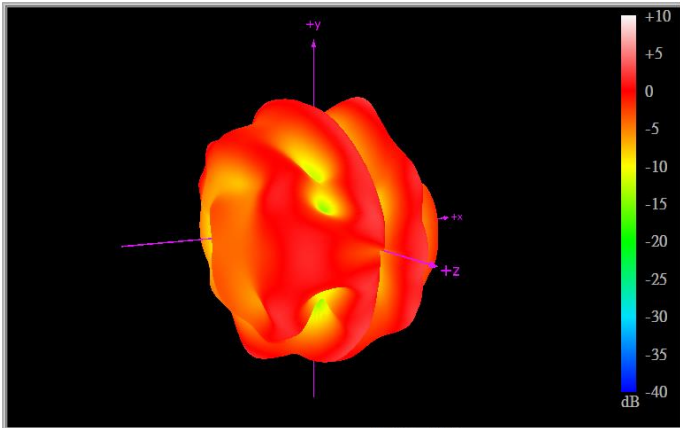

1990MHz

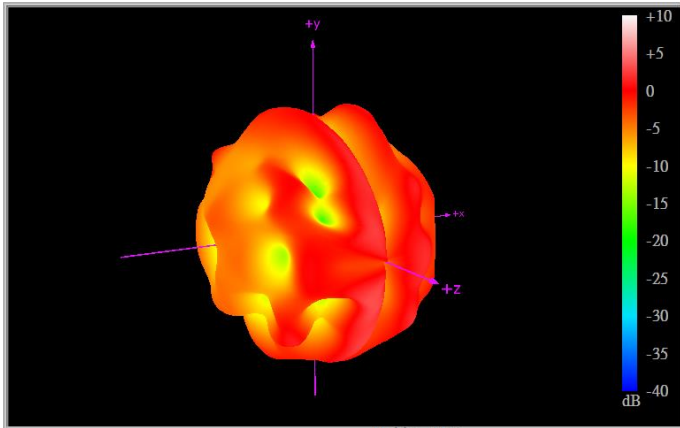

2170MHz

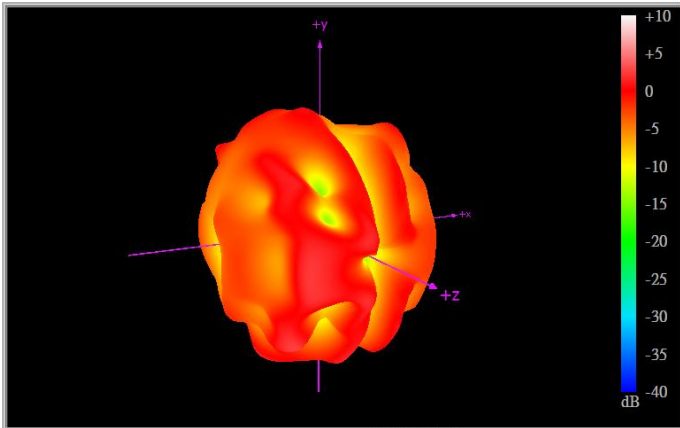

2500MHz

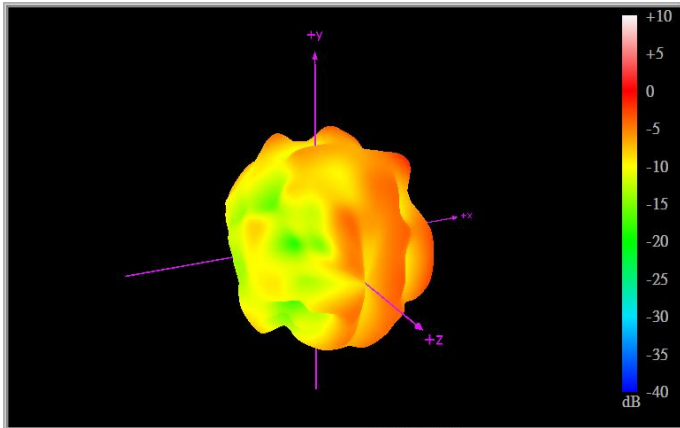

2690MHz



5. Drawing (Unit: mm)

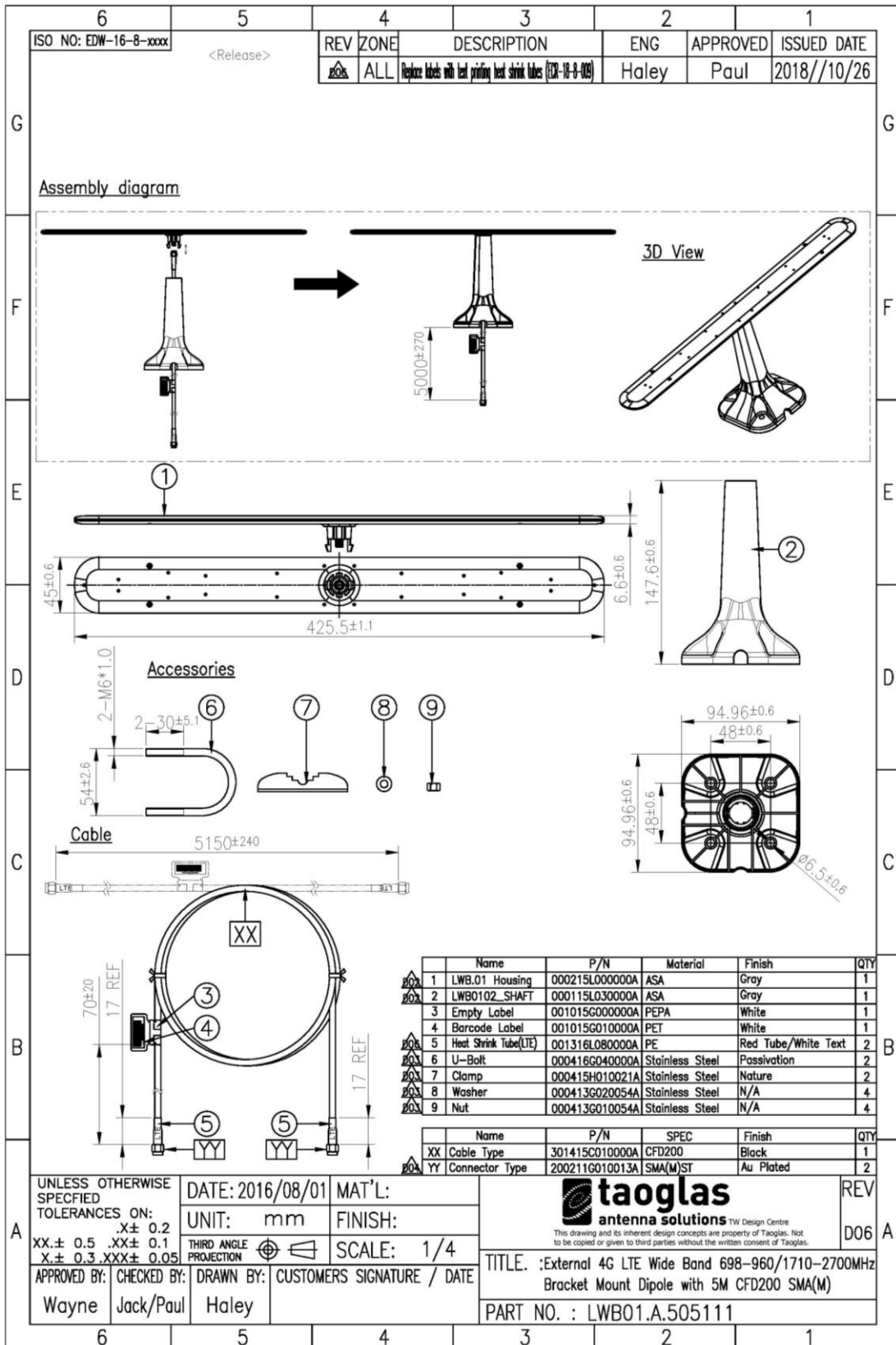

6. Packaging

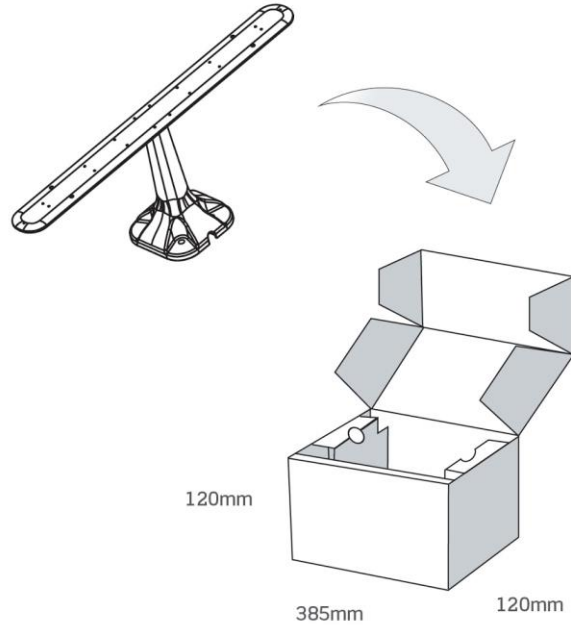

1 pc LWB01.A.505111 in box
Dimensions - 385*120*120mm
Weight - 743g

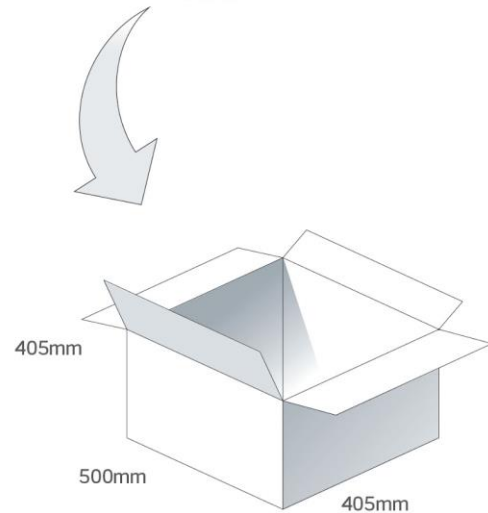

12 pcs LWB01.A.505111 in one carton
Carton Dimensions - 405*500*380mm
Weight - 10.12Kg

7. Installation Instructions

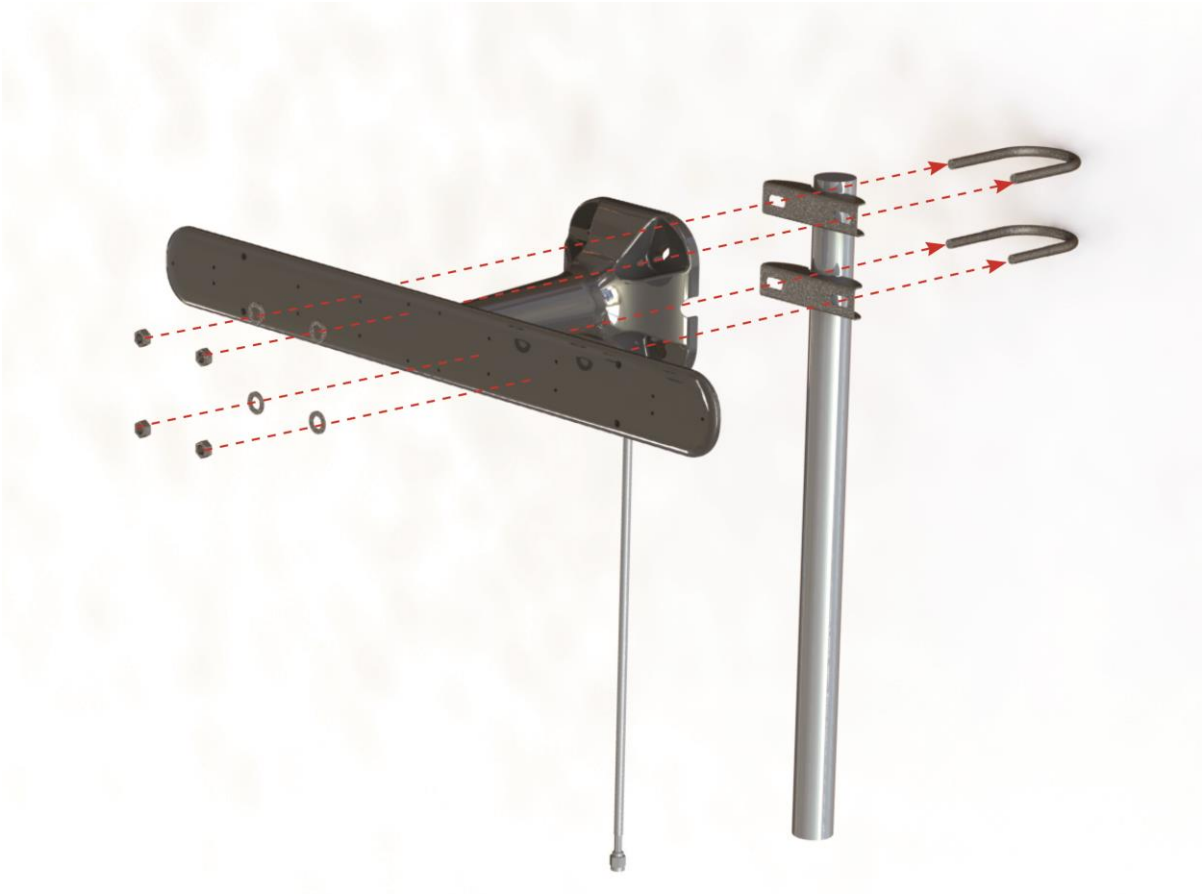

Taoglas makes no warranties based on the accuracy or completeness of the contents of this document and reserves the right to make changes to specifications and product descriptions at any time without notice. Taoglas reserves all rights to this document and the information contained herein.

Reproduction, use or disclosure to third parties without express permission is strictly prohibited.

Copyright © Taoglas Ltd.