

## Brief Description

The ZSPM1025A is a flexible true-digital single-phase PWM controller optimally configured for use with the Murata Power Solutions 25A Power Block OKLP-X/25-W12-C in smart digital power solutions.

The ZSPM1025A integrates a digital control loop, optimized for maximum flexibility and stability, as well as load step and steady-state performance. In addition, a rich set of protection and monitoring functions is provided. On-chip, non-volatile memory (NVM) and an I<sup>2</sup>C™ interface facilitate configuration.

IDT's PC-based Pink Power Designer™ graphic user interface (GUI) provides a user-friendly and easy-to-use interface to the ZSPM1025A for communication, monitoring, and configuration of the protection and sequencing features.

A downloadable reference solution is available, including a graphical user interface, layout guidelines, bill of materials, and step-by-step instructions.

## Features

- Programmable digital control loop
- Advanced digital control techniques
  - Tru-sample Technology™
  - State-Law Control™ (SLC)
  - Sub-cycle Response™ (SCR)
- Improved transient response and noise immunity
- Protection features
  - Over-current protection
  - Over-voltage protection (VIN, VOUT)
  - Under-voltage protection (VIN, VOUT)
  - Overloaded startup
  - Continuous retry (“hiccup”) mode for fault conditions
- Fuse-based NVM for improved reliability
- Operation from a single 5V or 3.3V supply
- Optional PMBus™ address selection without external resistors

## Benefits

- Fast time-to-market using off-the-shelf, optimally configured controller and power block
- Fast configurability and design flexibility
- Simplified design flow and high reliability via proven system design solution
- Reduced component count through system level integration
- Simplified monitoring for system power and thermal management
- Pin-to-pin compatible with the ZSPM1025C and ZSPM1025D PWM controllers, enabling point-of-load platform designs with or without digital communication
- Higher energy efficiency across all output loading conditions

## Available Support

- Evaluation Kit
- Reference Solution
- PC-based Pink Power Designer™ GUI

## Physical Characteristics

- Operation temperature: -40°C to +125°C
- V<sub>OUT</sub>: 0.35V to 3.6V
- Lead free (RoHS compliant) 24-pin QFN package (4 mm x 4 mm)

## ZSPM1025A Typical Application Diagram

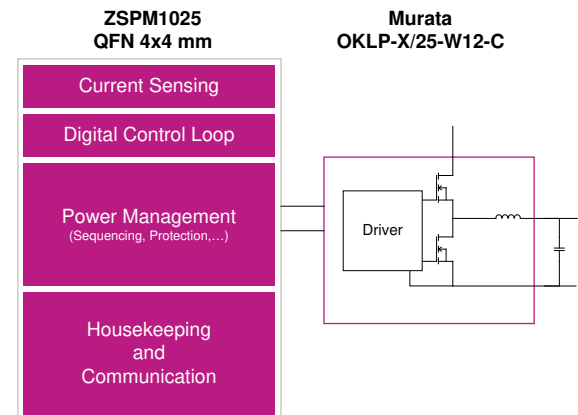

\* I<sup>2</sup>C™ is a registered trademark of NXP.

**ZSPM1025A Block Diagram**

- Typical Applications**
- ❖ Telecom Switches
  - ❖ Servers and Storage
  - ❖ Base Stations
  - ❖ Network Routers
  - ❖ Industrial Applications
  - ❖ Single-Rail/Single-Phase Supplies for Processors, ASICs, FPGAs, DSPs

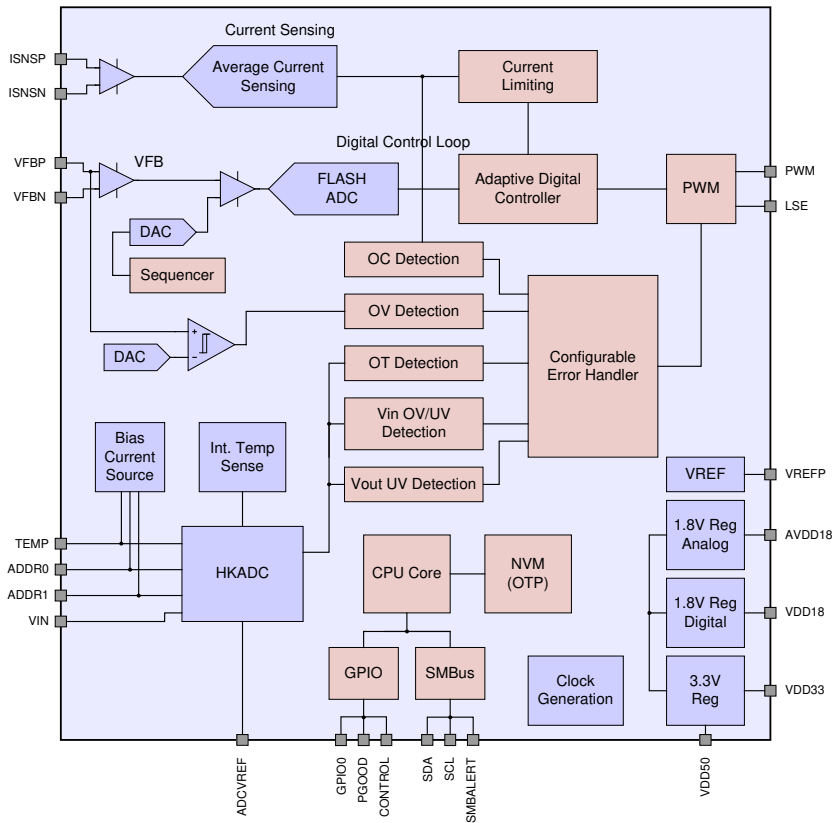

**Ordering Information**

Sales Code	Description	Package
ZSPM1025AA1W 1	ZSPM1025A Lead-free QFN24 — Temperature range: -40°C to +125°C	Reel
ZSPM8025-KIT	Evaluation Kit for ZSPM1025A with PMBus™ Communication Interface — Pink Power Designer™ GUI for kit can be downloaded from the IDT web site at <a href="http://www.IDT.com/ZSPM1025A">www.IDT.com/ZSPM1025A</a>	Kit

\* This product is sold under a limited license from PowerOne, Inc. related to digital power technology as set forth in U.S. Patent 7000125 and other related patents owned by PowerOne, Inc. This license does not extend to stand-alone power supply products.

## Contents

List of Figures .....	4
List of Tables .....	6
1 IC Characteristics .....	7
1.1. Absolute Maximum Ratings .....	7
1.2. Recommended Operating Conditions .....	7
1.3. Electrical Parameters .....	8
2 Product Summary .....	11
2.1. Overview .....	11
2.2. Pin Description .....	13
2.3. Available Packages .....	14
3 Functional Description .....	15
3.1. Power Supply Circuitry, Reference Decoupling, and Grounding .....	15
3.2. Reset/Start-up Behavior .....	15
3.3. Digital Power Control .....	15
3.3.1. Overview .....	15
3.3.2. Output Voltage Feedback .....	15
3.3.3. Digital Compensator .....	16
3.3.4. Power Sequencing and the CONTROL Pin .....	16
3.3.5. Pre-biased Start-up and Soft Stop .....	17
3.3.6. Current Sensing .....	18
3.3.7. Temperature Measurement .....	19
3.4. Fault Monitoring and Response Generation .....	19
3.4.1. Output Over/Under-Voltage .....	20
3.4.2. Output Current Protection and Limiting .....	20
3.4.3. Over-Temperature Protection .....	20
3.5. Configuration .....	20
4 PMBus™ Functionality .....	21
4.1. Introduction .....	21
4.2. Timing and Bus Specification .....	21
4.3. Address Selection via External Resistors .....	22
4.4. Configuration Registers .....	23
4.5. Monitoring .....	25
4.6. Additional Registers .....	25
4.7. Detailed Description of the Supported PMBus™ Commands .....	26
4.7.1. OPERATION .....	26
4.7.2. ON_OFF_CONFIG .....	26
4.7.3. CLEAR_FAULTS .....	26
4.7.4. VOUT_MODE .....	27

4.7.5.	VOUT_COMMAND .....	27
4.7.6.	STATUS_BYTE .....	27
4.7.7.	STATUS_WORD .....	28
4.7.8.	STATUS_VOUT .....	28
4.7.9.	STATUS_IOUT .....	29
4.7.10.	STATUS_INPUT .....	29
4.7.11.	STATUS_TEMPERATURE .....	29
4.7.12.	STATUS_CML .....	30
4.7.13.	STATUS_MFR_SPECIFIC .....	30
4.7.14.	READ_VIN .....	30
4.7.15.	READ_VOUT .....	30
4.7.16.	READ_IOUT .....	31
4.7.17.	READ_TEMPERATURE1 .....	31
4.7.18.	READ_TEMPERATURE2 .....	31
5	Application Information .....	32
5.1.	Typical Application Circuit .....	32
5.1.1.	Output Voltage Selection .....	34
5.1.2.	Output Capacitor Selection .....	34
5.2.	Typical Performance Measurements for the ZSPM1025A .....	34
5.2.1.	Typical Load Transient Response – Capacitor Range #1 – VOUT Range #1 .....	35
5.2.2.	Typical Load Transient Response – Capacitor Range #2 – VOUT Range #1 .....	36
5.2.3.	Typical Load Transient Response – Capacitor Range #3 – VOUT Range #1 .....	37
5.2.4.	Typical Load Transient Response – Capacitor Range #4 – VOUT Range #1 .....	38
5.2.5.	Typical Load Transient Response – Capacitor Range #1 – VOUT Range #2 .....	39
5.2.6.	Typical Load Transient Response – Capacitor Range #2 – VOUT Range #2 .....	40
5.2.7.	Typical Load Transient Response – Capacitor Range #3 – VOUT Range #2 .....	41
5.2.8.	Typical Load Transient Response – Capacitor Range #4 – VOUT Range #2 .....	42
6	Mechanical Specifications .....	43
7	Ordering Information .....	44
8	Related Documents .....	44
9	Glossary .....	44
10	Document Revision History .....	45

## List of Figures

Figure 2.1	Typical Application Circuit with a 5V Supply Voltage .....	11
Figure 2.2	Block Diagram .....	12
Figure 2.3	Pin-out QFN24 Package .....	14

Figure 3.1	Simplified Block Diagram of the Digital Compensation .....	16
Figure 3.2	Power Sequencing.....	17
Figure 3.3	Power Sequencing with Non-zero Off Voltage .....	17
Figure 3.4	Inductor Current Sensing Using the DCR Method.....	18
Figure 4.1	PMBus™ Timing Diagram .....	21
Figure 5.1	Application Circuit with a 5V Supply Voltage.....	32
Figure 5.2	5 to 15A Load Step – Min. Capacitance .....	35
Figure 5.3	15 to 5A Load Step – Min. Capacitance .....	35
Figure 5.4	5 to 15A Load Step – Max. Capacitance .....	35
Figure 5.5	15 to 5A Load Step – Max. Capacitance .....	35
Figure 5.6	Open Loop Bode Plots.....	35
Figure 5.7	5 to 15A Load Step – Min. Capacitance .....	36
Figure 5.8	15 to 5A Load Step – Min. Capacitance .....	36
Figure 5.9	5 to 15A Load Step – Max. Capacitance .....	36
Figure 5.10	15 to 5A Load Step – Min. Capacitance .....	36
Figure 5.11	Open Loop Bode Plots.....	36
Figure 5.12	5 to 15A Load Step – Min. Capacitance .....	37
Figure 5.13	15 to 5A Load Step – Min. Capacitance .....	37
Figure 5.14	5 to 15A Load Step – Max. Capacitance .....	37
Figure 5.15	15 to 5A Load Step – Max. Capacitance .....	37
Figure 5.16	Open Loop Bode Plots.....	37
Figure 5.17	5 to 15A Load Step – Min. Capacitance .....	38
Figure 5.18	15 to 5A Load Step – Min. Capacitance .....	38
Figure 5.19	5 to 15A Load Step – Max. Capacitance .....	38
Figure 5.20	15 to 5A Load Step – Max. Capacitance .....	38
Figure 5.21	Open Loop Bode Plots.....	38
Figure 5.22	5 to 20A Load Step – Min. Capacitance .....	39
Figure 5.23	20 to 5A Load Step – Min. Capacitance .....	39
Figure 5.24	5 to 20A Load Step – Max. Capacitance .....	39
Figure 5.25	20 to 5A Load Step – Max. Capacitance .....	39
Figure 5.26	Open Loop Bode Plots.....	39
Figure 5.27	5 to 20A Load Step – Min. Capacitance .....	40
Figure 5.28	20 to 5A Load Step – Min. Capacitance .....	40
Figure 5.29	5 to 20A Load Step – Max. Capacitance .....	40
Figure 5.30	20 to 5A Load Step – Max. Capacitance .....	40
Figure 5.31	Open Loop Bode Plots.....	40
Figure 5.32	5 to 20A Load Step – Min. Capacitance .....	41
Figure 5.33	20 to 5A Load Step – Min. Capacitance .....	41
Figure 5.34	5 to 20A Load Step – Max. Capacitance .....	41

Figure 5.35	20 to 5A Load Step – Max. Capacitance .....	41
Figure 5.36	Open Loop Bode Plots.....	41
Figure 5.37	5 to 20A Load Step – Min. Capacitance .....	42
Figure 5.38	20 to 5A Load Step – Min. Capacitance .....	42
Figure 5.39	5 to 20A Load Step – Max. Capacitance .....	42
Figure 5.40	20 to 5A Load Step – Max. Capacitance .....	42
Figure 5.41	Open Loop Bode Plots.....	42
Figure 6.1	Package Drawing.....	43

### List of Tables

Table 3.1	Fault Configuration Overview .....	19
Table 4.1	PMBus™ Timing Specification .....	21
Table 4.2	Supported Resistor Values for PMBus™ Address Selection .....	22
Table 4.3	PMBus™ Address Selection without Resistors .....	23
Table 4.4	List of Supported PMBus™ Configuration Registers.....	23
Table 4.5	List of Supported PMBus™ Status Registers.....	25
Table 4.6	Additional Supported PMBus™ Registers .....	25
Table 4.7	Supported PMBus™ Operation Modes .....	26
Table 4.8	Supported PMBus™ ON_OFF_CONFIG Options.....	26
Table 5.1	Passive Component Values for the Application Circuit .....	33
Table 5.2	Output Voltage Ranges .....	34
Table 5.3	Recommended Output Capacitor Ranges.....	34

# 1 IC Characteristics

Note: The absolute maximum ratings are stress ratings only. The ZSPM1025A might not function or be operable above the recommended operating conditions. Stresses exceeding the absolute maximum ratings might also damage the device. In addition, extended exposure to stresses above the recommended operating conditions might affect device reliability. IDT does not recommend designing to the “Absolute Maximum Ratings.”

## 1.1. Absolute Maximum Ratings

PARAMETER	PINS	CONDITIONS	MIN	TYP	MAX	UNITS
<b>Supply voltages</b>						
5 V supply voltage	VDD50	dV/dt < 0.15V/μs	-0.3		5.5	V
Maximum slew rate					0.15	V/μs
3.3 V supply voltage	VDD33		-0.3		3.6	V
1.8 V supply voltage	VDD18 AVDD18		-0.3		2.0	V
<b>Digital pins</b>						
Digital I/O pins	SCL SDA SMBALERT GPIO0 CONTROL PGOOD LSE PWM		-0.3		5.5	V
<b>Analog pins</b>						
Current sensing	ISNSP, ISNSN		-0.3		5.5	V
Voltage feedback	VFBP VFBN		-0.3		2.0	V
All other analog pins	ADCVREF VREFP TEMP VIN ADDR0 ADDR1		-0.3		2.0	V
<b>Ambient conditions</b>						
Storage temperature T <sub>STOR</sub>			-40		150	°C

## 1.2. Recommended Operating Conditions

PARAMETER	Symbol	CONDITIONS	MIN	TYP	MAX	UNITS
Ambient operation temperature	T <sub>AMB</sub>		-40		125	°C
Thermal resistance junction to ambient	θ <sub>JA</sub>			40		K/W

### 1.3. Electrical Parameters

PARAMETER	SYMBOL	CONDITIONS	MIN	TYP	MAX	UNITS
<b>Supply voltages</b>						
5 V supply voltage —VDD50 pin	$V_{VDD50}$		4.75	5.0	5.25	V
5 V supply current	$I_{VDD50}$	VDD50=5.0 V		23		mA
3.3 V supply voltage	$V_{VDD33}$	Supply for both the VDD33 and VDD50 pins if the internal 3.3V regulator is not used.	3.0	3.3	3.6	V
3.3 V supply current	$I_{VDD33}$	VDD50=VDD33=3.3 V		23		mA
<b>Internally generated supply voltages</b>						
3.3 V supply voltage—VDD33 pin	$V_{VDD33}$	VDD50=5.0 V	3.0	3.3	3.6	V
3.3 V output current	$I_{VDD33}$	VDD50=5.0 V			2.0	mA
1.8 V supply voltages—AVDD18 and VDD18 pins	$V_{AVDD18}$ $V_{VDD18}$	VDD50=5.0 V	1.72	1.80	1.98	V
1.8 V output current					0	mA
Power on reset (POR) threshold for VDD33 pin – on	$V_{TH\_POR\_ON}$			2.8		V
Power on reset threshold for VDD33 pin – off	$V_{TH\_POR\_OFF}$			2.6		V
<b>Digital IO pins (GPIO0, CONTROL, PGOOD)</b>						
Input high voltage		VDD33=3.3 V	2.0			V
Input low voltage		VDD33=3.3 V			0.8	V
Output high voltage		VDD33=3.3 V	2.4		VDD33	V
Output low voltage					0.5	V
Input leakage current					±1.0	μA
Output current – high					2.0	mA
Output current – low					2.0	mA
<b>Digital IO pins with tri-state capability (LSE, PWM)</b>						
Output high voltage		VDD33=3.3 V	2.4		VDD33	V
Output low voltage					0.5	V
Output current – high					2.0	mA
Output current – low					2.0	mA
Tri-state leakage current					±1.0	μA
<b>SMBus pins (SCL, SDA, SMBALERT) – open drain</b>						
Input high voltage		VDD33=3.3 V	2.0			V
Input low voltage		VDD33=3.3 V			0.8	V
Maximum bus voltage					5.25	V



PARAMETER	SYMBOL	CONDITIONS	MIN	TYP	MAX	UNITS
Output current – low					2.0	mA
<b>Output voltage*</b>						
Set-point voltage			0		1.4	V
Set-point resolution				1.4		mV
Set-point accuracy		VOUT=1.2 V		1		%
*Without external voltage divider (see section 3.3.2)						
<b>Inductor current measurement</b>						
Common mode voltage — ISNSP and ISNSN pins relative to AGND			0		5.0	V
Differential voltage range across ISNSP and ISNSN pins					±100	mV
Accuracy				5		%
Recommended DCR sense voltage for maximum output current			10			mV
<b>Digital pulse width modulator</b>						
Switching frequency	f <sub>sw</sub>			500		kHz
Resolution				163		ps
Frequency accuracy				2.0		%
<b>Over-voltage protection</b>						
<b>Reference DAC</b>						
Set-point voltage			0		1.58	V
Resolution				25		mV
Set point accuracy				2		%
<b>Comparator</b>						
Hysteresis				35		mV
<b>Housekeeping analog-to-digital converter (HKADC) input pins</b>						
Input voltage—TEMP, VIN, ADDR0, and ADDR1 pins			0		1.44	V
Source impedance Vin sensing					3	kΩ
ADC resolution				0.7		mV

PARAMETER	SYMBOL	CONDITIONS	MIN	TYP	MAX	UNITS
<b>External temperature measurement **</b>						
Bias currents for external temperature sensing —TEMP pin				60		μA
Resolution—TEMP pin				0.16		K
Accuracy of measurement—TEMP pin				±5.0		K
** Supported sense elements: PN-junction						
<b>Internal temperature measurement</b>						
Resolution				0.22		K
Accuracy of measurement				±5.0		K

## 2 Product Summary

### 2.1. Overview

The ZSPM1025A is a flexible true-digital single-phase PWM controller optimally configured for use with the Murata Power Solutions 25A Power Block OKLP-X/25-W12-C in smart digital power solutions. It offers a PMBus™-configurable digital power control loop, incorporating output voltage sensing and average inductor current sensing, bundled with extensive fault monitoring and handling options.

Several different functional units are integrated in the device. A dedicated digital control loop is used to provide fast loop response and optimal output voltage regulation. This includes output voltage sensing, average inductor current sensing, a digital control law, and a digital pulse-width modulator (DPWM). In parallel, a dedicated, configurable error handler allows for fast and flexible detection of error signals and their appropriate handling. A housekeeping analog-to-digital converter (HKADC) ensures the reliable and efficient measurement of environmental signals, such as input voltage and temperature. An application-specific, low-energy integrated microcontroller is used to control the overall system. Among other things, it manages configuration of the various logic units and handles the PMBus™ communication protocol. A PMBus™/SMBus/I<sup>2</sup>C™ interface is incorporated to connect with the outside world; supported by control and power-good signals.

**Figure 2.1** Typical Application Circuit with a 5V Supply Voltage

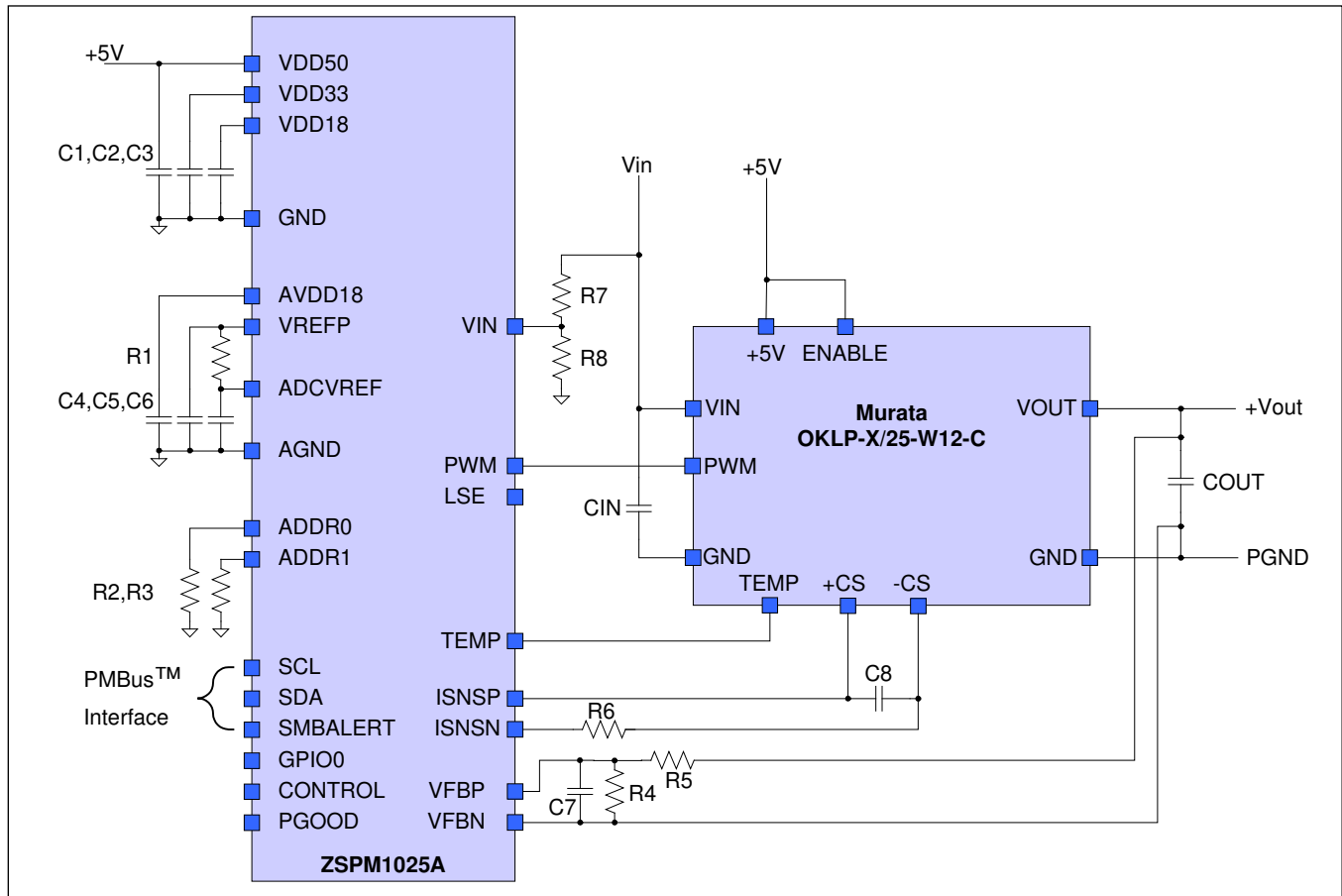

A high-reliability, high-temperature one-time programmable memory (OTP) is used to store configuration parameters. All required bias and reference voltages are internally derived from the external supply voltage.

Figure 2.2 Block Diagram

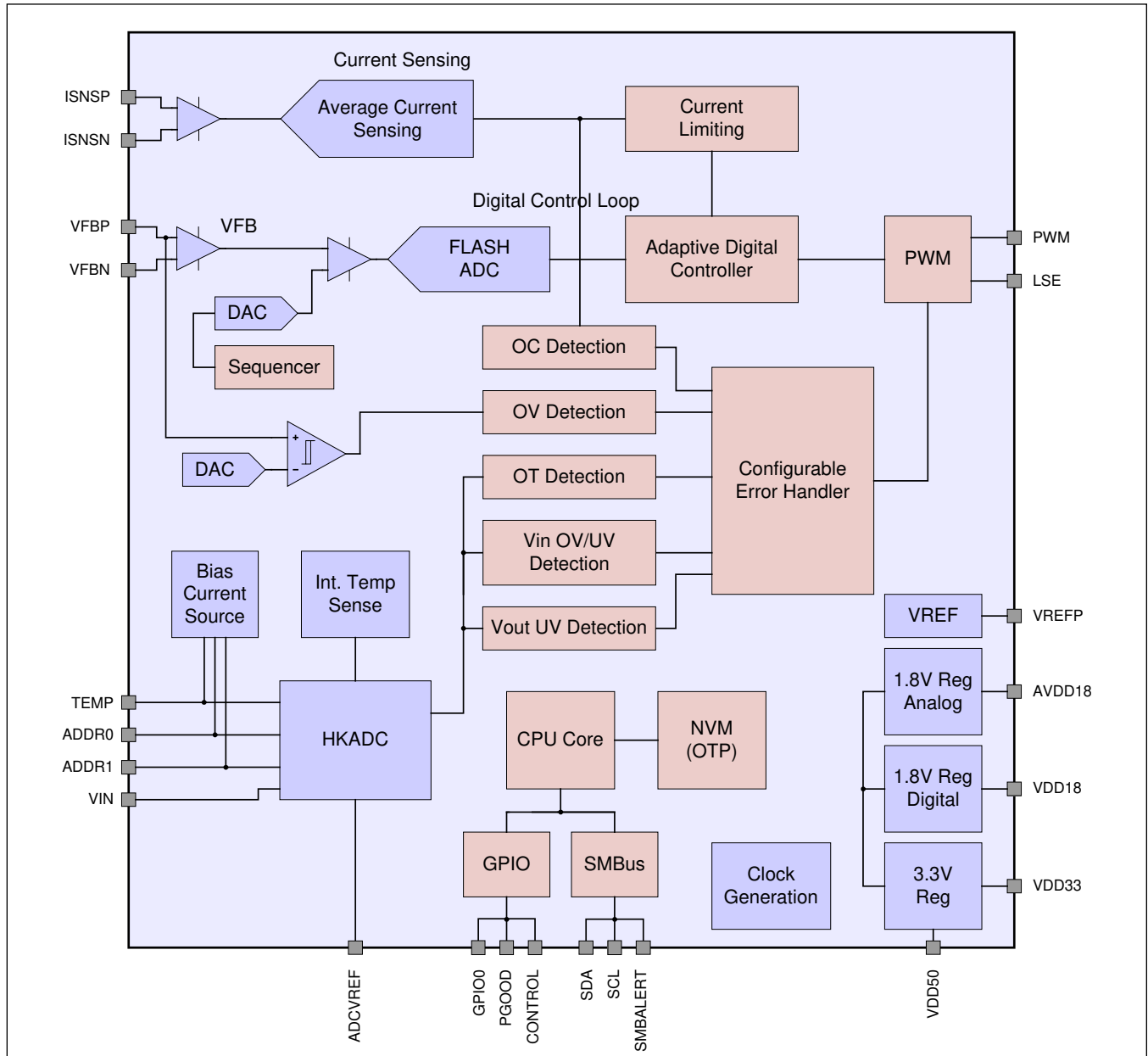

## 2.2. Pin Description

Pin	Name	Direction	Type	Description
1	AGND	Input	Supply	Analog Ground
2	VREFP	Output	Supply	Reference Terminal
3	VFBP	Input	Analog	Positive Input of Differential Feedback Voltage Sensing
4	VFBN	Input	Analog	Negative Input of Differential Feedback Voltage Sensing
5	ISNSP	Input	Analog	Positive Input of Differential Current Sensing
6	ISNSN	Input	Analog	Negative Input of Differential Current Sensing
7	TEMP	Input	Analog	Connection to External Temperature Sensing Element
8	VIN	Input	Analog	Power Supply Input Voltage Sensing
9	ADDR0	Input	Analog	SMBus Address Selection 0
10	ADDR1	Input	Analog	SMBus Address Selection 1
11	PWM	Output	Digital	High-side FET Control Signal
12	LSE	Output	Digital	Low-side FET Control Signal
13	PGOOD	Output	Digital	PGOOD Output (Internal Pull-Down)
14	CONTROL	Input	Digital	Control Input
15	GPIO0	Input/Output	Digital	General Purpose Input/Output Pin
16	SMBALERT	Output	PMBus™	SMBus Alert Output
17	SDA	Input/Output	PMBus™	SMBus Shift Data I/O
18	SCL	Input	PMBus™	SMBus Shift Clock Input (Slave-only)
19	GND	Input	Supply	Digital Ground
20	VDD18	Output	Supply	Internal 1.8 V Digital Supply Terminal
21	VDD33	Input/Output	Supply	3.3 V Supply Voltage Terminal
22	VDD50	Input	Supply	5.0 V Supply Voltage Terminal
23	AVDD18	Output	Supply	Internal 1.8 V Analog Supply Terminal
24	ADCVREF	Input	Analog	Analog-to-Digital Converter (ADC) Reference Terminal
PAD	PAD	Input	Supply	Exposed PAD, Digital Ground

### 2.3. Available Packages

The ZSPM1025A is available in a 24-pin QFN package. The pin-out is shown in Figure 2.3. The mechanical drawing of the package can be found in Figure 6.1.

**Figure 2.3 Pin-out QFN24 Package**

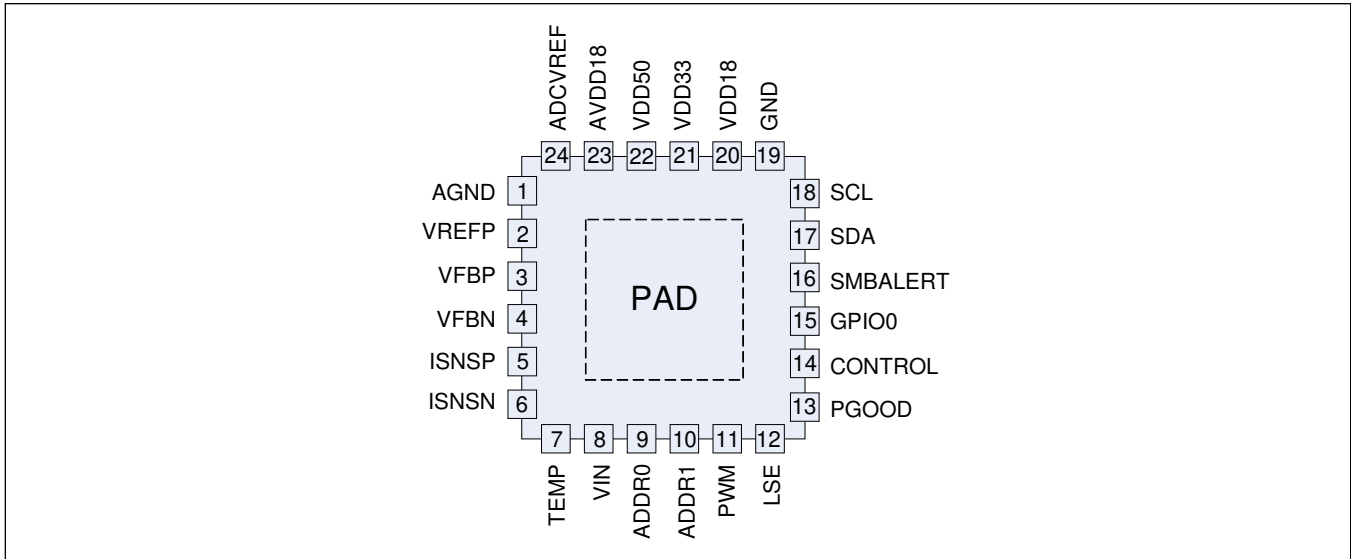

## 3 Functional Description

### 3.1. Power Supply Circuitry, Reference Decoupling, and Grounding

The ZSPM1025A incorporates several internal power regulators in order to derive all required supply and bias voltages from a single external supply voltage. This supply voltage can be either 5 V or 3.3 V depending on whether the internal 3.3 V regulator should be used. If the internal 3.3 V regulator is not used, 3.3 V must be supplied to the 3.3 and 5 V supply pins. Decoupling capacitors are required at the VDD33, VDD18, and AVDD18 pins (1.0  $\mu$ F minimum; 4.7  $\mu$ F recommended). If the 5.0 V supply voltage is used, i.e. the internal 3.3 V regulator is used, a small load current can be drawn from the VDD33 pin. This can be used to supply pull-up resistors, for example.

The reference voltages required for the analog-to-digital converters are generated within the ZSPM1025A. External decoupling must be provided between the VREFP and ADCVREF pins. Therefore, a 4.7  $\mu$ F capacitor is required at the VREFP pin and a 100 nF capacitor is required at the ADCVREF pin. The two pins should be connected with approximately 50  $\Omega$  resistance in order to provide sufficient decoupling between the pins.

Three different ground connections (the pad, AGND pin, and GND pin) are available on the outside of the package. These should be connected together to a single ground tie. A differentiation between analog and digital ground is not required.

### 3.2. Reset/Start-up Behavior

The ZSPM1025A employs an internal power-on-reset (POR) circuit to ensure proper start up and shut down with a changing supply voltage. Once the supply voltage increases above the POR threshold voltage, the ZSPM1025A begins the internal start-up process. Upon its completion, the device is ready for operation.

### 3.3. Digital Power Control

#### 3.3.1. Overview

The digital power control loop consists of the integral parts required for the control functionality of the ZSPM1025A. A high-speed analog front-end is used to digitize the output voltage. A digital control core uses the acquired information to provide duty-cycle information to the PWM, which controls the drive signals to the power stage.

#### 3.3.2. Output Voltage Feedback

The voltage feedback signal is sampled with a high-speed analog front-end. The feedback voltage is differentially measured and subtracted from the voltage reference provided by a reference digital-to-analog converter (DAC) using an error amplifier. A flash ADC is then used to convert the voltage into its digital equivalent. This is followed by internal digital filtering to improve the system's noise rejection.

An external feedback divider is required for output voltages above 1.20V. The reference DAC generates a voltage up to 1.44 V. Keeping the voltage on the feedback pin (VFBP) below 1.20 V guarantees sufficient headroom for the output voltage compensation loop.

### 3.3.3. Digital Compensator

The sampled output voltage is processed by a digital control loop in order to modulate the DPWM output signals controlling the power stage. This digital control loop works as a voltage-mode controller using a PID-type compensation. The basic structure of the controller is shown in Figure 3.1. The proprietary State-Law™ Control (SLC) concept features two parallel compensators, steady-state operation, and fast transient operation. The ZSPM1025A implements fast, reliable switching between the different compensation modes in order to ensure good transient performance and quiet steady state. This allows tuning the compensators individually for the respective needs; i.e. quiet steady-state and fast transient performance.

**Figure 3.1 Simplified Block Diagram of the Digital Compensation**

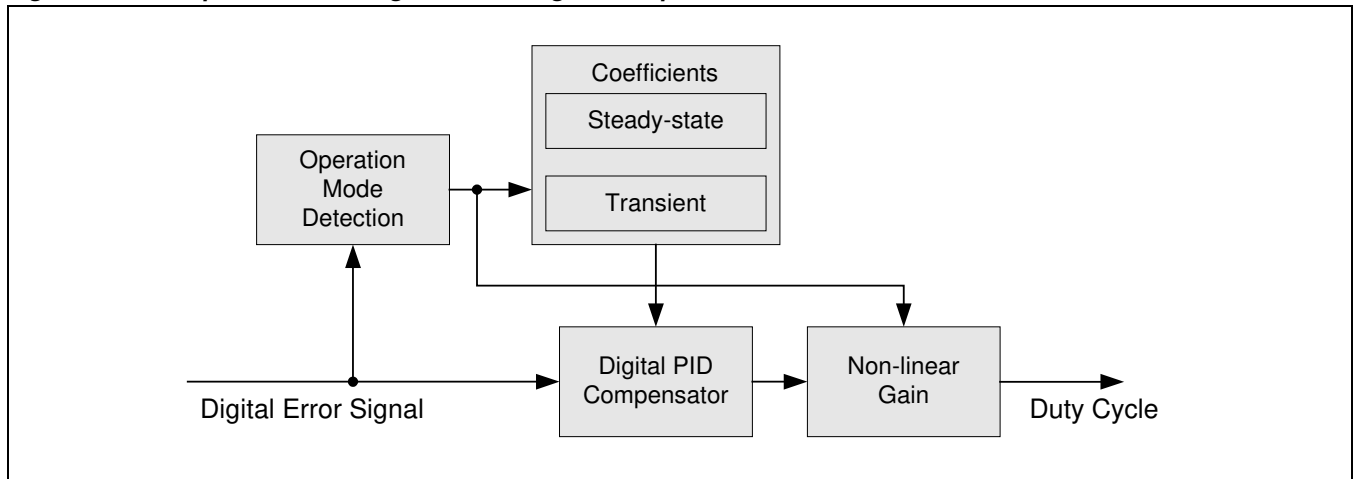

Three additional techniques are used to improve transient performance further.

- Tru-sample Technology™ is used to acquire fast, accurate, and continuous information about the output voltage so that the device can react quickly to any change in output voltage. Tru-sample Technology™ reduces phase-lag caused by sampling delays, reduces noise sensitivity, and improves transient performance.
- The Sub-cycle Response™ (SCR) technique, a method to drive the DPWM asynchronously during load transients, allows limiting the maximum deviation of the output voltage and recharging the output capacitors faster.
- A non-linear gain adjustment is used during large load transients to boost the loop gain and reduce the settling time.

### 3.3.4. Power Sequencing and the CONTROL Pin

The ZSPM1025A supports power-sequencing features including programmable ramp up/down and delays. The typical sequence of events is shown in Figure 3.2 and follows the PMBus™ standard. The individual values can be set using the appropriate configuration setting, which can be selected using the Pink Power Designer™ GUI. Three different configuration options are supported to turn the device on. The device can be configured to turn on immediately after POR, on an OPERATION\_ON command, or on an edge on the CONTROL pin.



**Figure 3.2 Power Sequencing**

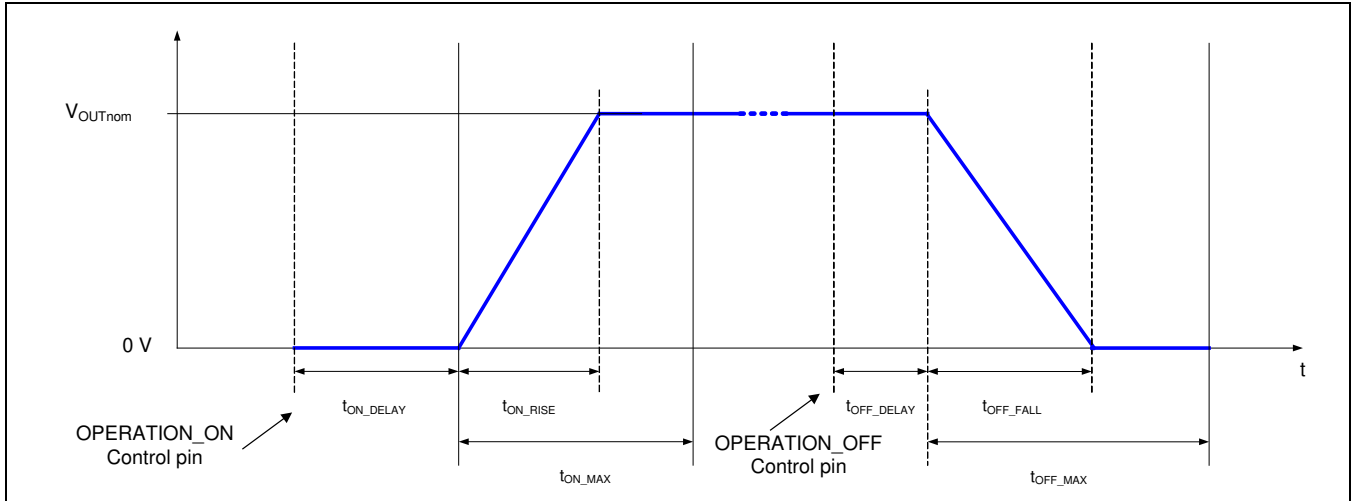

**3.3.5. Pre-biased Start-up and Soft Stop**

Dedicated pre-biased start-up logic ensures proper start-up of the power converter when the output capacitors are pre-charged to a non-zero output voltage. Closed-loop stability is ensured during this phase.

The ZSPM1025A also supports pre-biased off, i.e. the output voltage is not ramped down to zero and instead remains at a predefined level ( $V_{OFF\_nom}$ ). This value can be configured via the Pink Power Designer™. After receiving the shutdown command via the PMBus™ or the CONTROL pin, the ZSPM1025A ramps down the output voltage value to the predefined value. Once the value is reached, the PWM output will be put into tri-state mode in order to put the output driver into its tri-state mode.

**Figure 3.3 Power Sequencing with Non-zero Off Voltage**

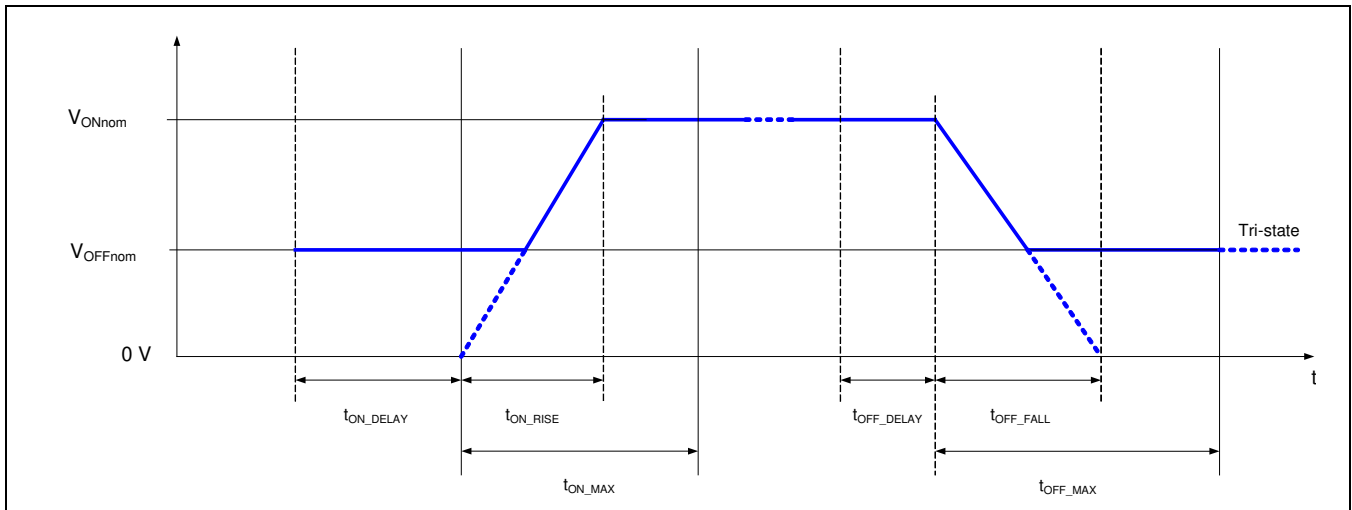

### 3.3.6. Current Sensing

The ZSPM1025A offers cycle-by-cycle average current sensing with configurable over-current protection. A dedicated ADC is used to provide fast and accurate current information over the switching period. The acquired information is compared with configurable current thresholds to report warning and error levels to the user. DCR current sensing across the inductor and dedicated shunt resistors is supported. Additionally, the device uses DCR temperature compensation via the external temperature-sensing element. This increases the accuracy of the current sense method by counteracting the significant change of the DCR over temperature.

To acquire accurate current information, the selection of the current-sensing circuit is of critical importance. The schematic of the required current-sensing circuitry is shown in Figure 3.4 for the widely used DCR current-sensing method, which uses the parasitic resistance of the inductor to acquire the current information. The principle is based on a matched time-constant between the inductor and the low-pass filter built from a 2.15kΩ resistor mounted on the Murata Power Block and C8. Resistor R6 should be a precision 2.15kΩ resistor in order to provide good DC voltage rejection, .i.e. reduce the influence of the output voltage level in the current measurement.

**Figure 3.4 Inductor Current Sensing Using the DCR Method**

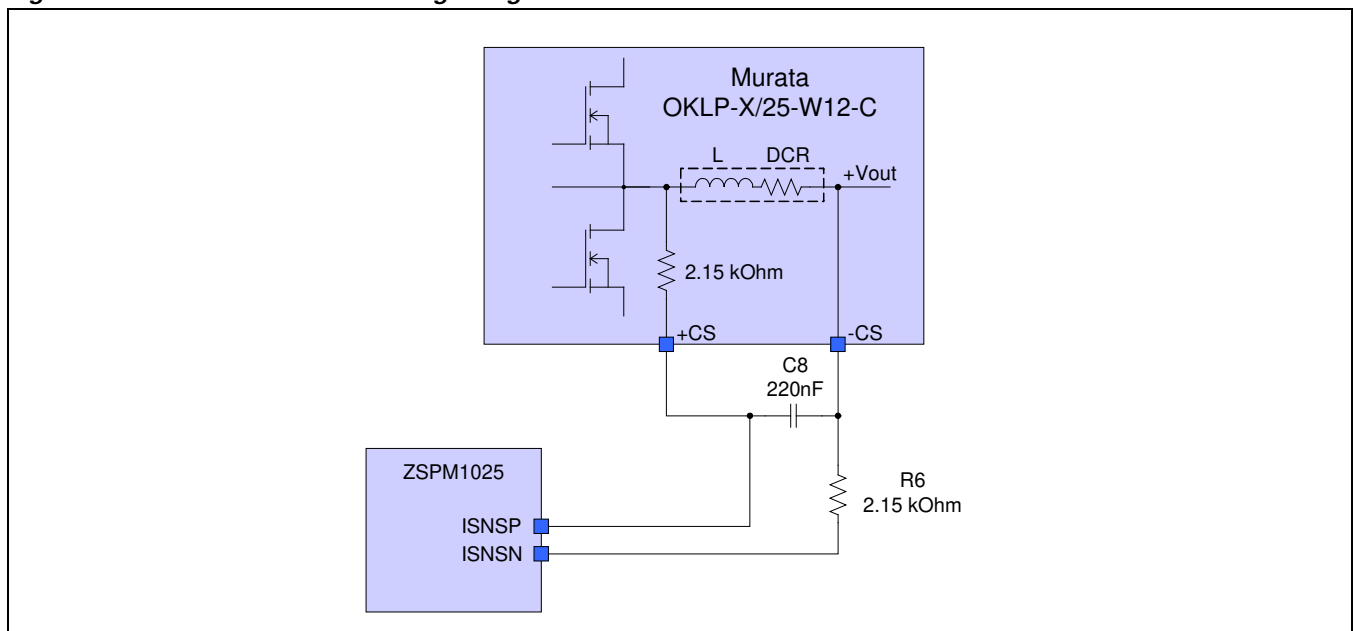

End-of-line calibration is supported so that the ZSPM1025A can achieve improved accuracy over the full output current range. The full calibration method is detailed in the *ZSPM10xx Application Note—Programming and Calibration*. This allows the user to correct mismatches between the nominal DCR value used to configure the device and the actual DCR value in the application caused by effects such as manufacturing variations. The calibration range is limited to +/- 50% of the nominal DCR value.

Additionally, in order to improve the accuracy of the current measurement, which can be adversely affected by the temperature coefficient of the inductor’s DCR, the ZSPM1025A features temperature compensation via external temperature sensing. The temperature of the inductors is measured with an external temperature-sensing element placed close to the inductor. This information is used to adapt the gain of the current sense path to compensate for the increase in actual DCR.

**3.3.7. Temperature Measurement**

The ZSPM1025A features two independent temperature measurement units. The internal temperature sensing measures the temperatures inside the ZSPM1025A. The external temperature sensor is placed on the Murata Power Block. The ZSPM1025A drives 60µA into the external temperature-sensing element and measures the voltage on the TEMP pin. The Pink Power Designer™ GUI must be used to select the offset for configuration of the external temperature measurement. A temperature-offset calibration is highly recommended.

**3.4. Fault Monitoring and Response Generation**

The ZSPM1025A monitors various signals during operation. Depending on the selected configuration, it can respond to events generated by these signals. A wide range of options is configurable via the Pink Power Designer™. Typical monitoring within the ZSPM1025A is a three-step process. First, an event is detected via a configurable set of thresholds. This event is then digitally filtered before the ZSPM1025A reacts with a defined response depending on the fault condition. For most monitored signals, a warning and a fault threshold can be configured. A warning typically sets a status flag (see section 4.7.6) but does not trigger a response; whereas a fault also generates a response.

The warning and fault events can be enabled for each parameter that the ZSPM1025 monitors (see Table 3.1). The SMBALERT signal is asserted by the ZSPM1025A for any warning or fault that has been enabled. An overview of the faults that the ZSPM1025A can detect and the response to each fault is given in Table 3.1.

**Table 3.1 Fault Configuration Overview**

Fault	Response Type
Output Over-Voltage	Low impedance
Output Under-Voltage	Low impedance
Input Over-Voltage	Off
Input Under-Voltage	Off
Over-Current	Low impedance
External Over-Temperature	Off
Internal Over-Temperature	Off

The ZSPM1025A supports different response types depending on the fault detected. An “Off” response ramps the output voltage down using the falling-edge sequencer settings. The final state of the output signals depends on the value selected for V<sub>OFF\_nom</sub>. The “low-impedance” response clamps the PWM output to PGND.

The controller fault handling will infinitely try to restart the converter on a fault condition. In analog controllers, this infinite re-try feature is also known as “hiccup mode.”

### **3.4.1. Output Over/Under-Voltage**

To prevent damage to the load, the ZSPM1025A utilizes an output over-voltage protection circuit. The voltage at VFBP is continuously compared with a configurable fault threshold using a high-speed analog comparator. The fault threshold can be configured using the Pink Power Designer™ GUI. If the voltage exceeds the configured threshold, the fault response is generated and the PWM output is set to low impedance (clamped to PGND). The voltage fault level is generated by a 6-bit DAC with a reference voltage of 1.60 V resulting in 25 mV resolution.

The output voltage is also sampled using the HKADC and continuously compared to a configurable output over-voltage warning threshold. The warning threshold can be configured using the Pink Power Designer™ GUI. If the output voltage exceeds this threshold, a warning is generated.

The ZSPM1025A also monitors the output voltage with two lower thresholds. If the output voltage is below the under-voltage warning level and above the under-voltage fault level, an output voltage under-voltage warning is triggered. If the output voltage falls below the fault level, a fault event is generated and the output is set to low impedance.

### **3.4.2. Output Current Protection and Limiting**

The ZSPM1025A continuously monitors the average inductor current and utilizes this information to protect the power supply against excessive output current. The output over-current warning and fault threshold levels can be configured using the Pink Power Designer™ GUI. If the fault level is exceeded, the PWM output is set to low impedance.

### **3.4.3. Over-Temperature Protection**

The ZSPM1025A monitors internal and external temperature. For each, a warning and a fault level can be configured and an appropriate response can be enabled.

## **3.5. Configuration**

The ZSPM1025A incorporates two different sets of configuration parameters (see section 4.4). The first set of configuration parameters can be configured during design time and cannot be changed during run-time. The second set of configuration parameters can be configured during design time, but can also be reconfigured during run-time using the appropriate PMBus™ command. Note that the second set of reconfigured values is not stored in the OTP memory, so they are lost during power cycling the device.

In order to evaluate the device and its configuration on the bench, a special engineering mode is supported by the device and Pink Power Designer™. In this engineering mode, the device can be reconfigured multiple times without writing the configuration into the OTP. During this mode, the device starts up after power-on reset in an unconfigured state. The Pink Power Designer™ then provides the configuration to the ZSPM1025A, enabling full operation without actually configuring the OTP. The engineer can use this mode to evaluate the configuration on the bench. However, the configuration will be lost upon power-on-reset.

After the design engineer has determined the final configuration options, an OTP image can be created that is then written into the ZSPM1025A. This can be either on the bench using the Pink Power Designer™ or in end-of-line testing during mass production.

## 4 PMBus™ Functionality

### 4.1. Introduction

The ZSPM1025A supports the PMBus™ protocol to enable configuration, monitoring, and fault management during run-time.

The PMBus™ host controller is connected to the ZSPM1025A via the PMBus™ pins (SDA and SCL). A dedicated SMBALERT pin is provided to notify the host that new status information is present.

The ZSPM1025A supports packet error correction (PEC) according to the PMBus™ specification.

### 4.2. Timing and Bus Specification

Timing for the PMBus™ signals is given in Figure 4.1. The PMBus™ signal SMBCLK is the shift clock input on the SCL pin on the ZSPM1025A (slave only) and the SMBDAT signal is the shift data input/output on the SDA pin.

Figure 4.1 PMBus™ Timing Diagram

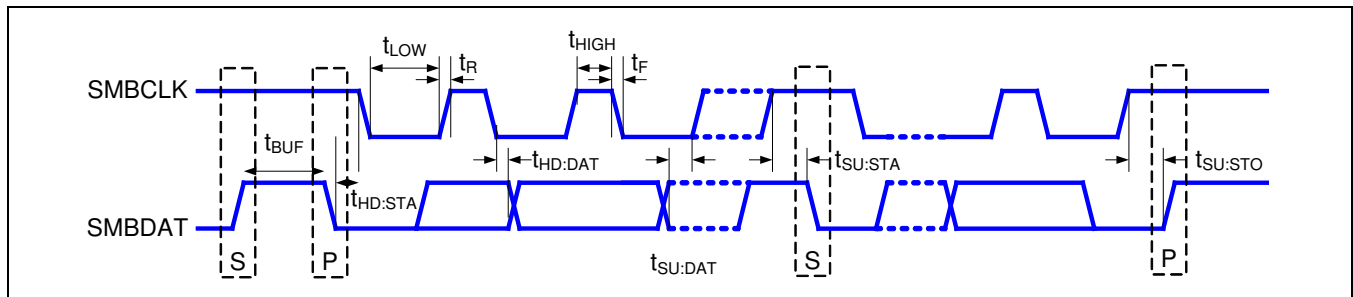

Table 4.1 PMBus™ Timing Specification

PARAMETER	SYMBOL	CONDITIONS	MIN	TYP	MAX	UNITS
SMBus operation frequency	$f_{SMB}$		10	400	500	kHz
Bus free time between start and stop	$t_{BUF}$		1.3			$\mu s$
Hold time after start condition	$t_{HD:STA}$		0.6			$\mu s$
Repeat start condition setup time	$t_{SU:STA}$		0.6			$\mu s$
Stop condition setup time	$t_{SU:STO}$		0.6			$\mu s$
Data hold time	$t_{HD:DAT}$		300			ns
Data setup time	$t_{SU:DAT}$		100			ns
Clock low time-out	$t_{TIMEOUT}$			25	35	$\mu s$
Clock low period	$t_{LOW}$		1.3			$\mu s$
Clock high period	$t_{HIGH}$		0.6			$\mu s$
Cumulative clock low extend time	$t_{LOW:SEXT}$				25	ms
Clock or data fall time	$t_F$				300	ns
Clock or data rise time	$t_R$				300	ns

### 4.3. Address Selection via External Resistors

PMBus™ uses a 7-bit device address to identify different devices connected to the bus. This address can be selected via external resistors connected to the ADDR<sub>x</sub> pins.

The resistor values are sensed using the internal ADC during the initialization phase and the appropriate PMBus™ address is selected. Note that the respective circuitry is only active during the initialization phase; hence no DC voltage can be measured at the pins. The supported PMBus™ addresses and the values of the respective required resistors are listed in Table 4.2.

**Table 4.2 Supported Resistor Values for PMBus™ Address Selection**

Address (Hex)	ADDR1 Ω	ADDR0 Ω	Address (Hex)	ADDR1 Ω	ADDR0 Ω	Address (Hex)	ADDR1 Ω	ADDR0 Ω	Address (Hex)	ADDR1 Ω	ADDR0 Ω
64	0	0	32	1.2 k	0	64	2.7 k	0	96	4.7 k	0
1*	0	680	33	1.2 k	680	65	2.7 k	680	97*	4.7 k	680
2*	0	1.2 k	34	1.2 k	1.2 k	66	2.7 k	1.2 k	98	4.7 k	1.2 k
3*	0	1.8 k	35	1.2 k	1.8 k	67	2.7 k	1.8 k	99	4.7 k	1.8 k
4*	0	2.7 k	36	1.2 k	2.7 k	68	2.7 k	2.7 k	100	4.7 k	2.7 k
5*	0	3.9 k	37	1.2 k	3.9 k	69	2.7 k	3.9 k	101	4.7 k	3.9 k
6*	0	4.7 k	38	1.2 k	4.7 k	70	2.7 k	4.7 k	102	4.7 k	4.7 k
7*	0	5.6 k	39	1.2 k	5.6 k	71	2.7 k	5.6 k	103	4.7 k	5.6 k
8*	0	6.8 k	40*	1.2 k	6.8 k	72	2.7 k	6.8 k	104	4.7 k	6.8 k
9	0	8.2 k	41	1.2 k	8.2 k	73	2.7 k	8.2 k	105	4.7 k	8.2 k
10	0	10 k	42	1.2 k	10 k	74	2.7 k	10 k	106	4.7 k	10 k
11	0	12 k	43	1.2 k	12 k	75	2.7 k	12 k	107	4.7 k	12 k
12*	0	15 k	44	1.2 k	15 k	76	2.7 k	15 k	108	4.7 k	15 k
13	0	18 k	45	1.2 k	18 k	77	2.7 k	18 k	109	4.7 k	18 k
14	0	22 k	46	1.2 k	22 k	78	2.7 k	22 k	110	4.7 k	22 k
15	0	27 k	47	1.2 k	27 k	79	2.7 k	27 k	111	4.7 k	27 k
16	680	0	48	1.8 k	0	80	3.9 k	0	112	5.6 k	0
17	680	680	49	1.8 k	680	81	3.9 k	680	113	5.6 k	680
18	680	1.2 k	50	1.8 k	1.2 k	82	3.9 k	1.2 k	114	5.6 k	1.2 k
19	680	1.8 k	51	1.8 k	1.8 k	83	3.9 k	1.8 k	115	5.6 k	1.8 k
20	680	2.7 k	52	1.8 k	2.7 k	84	3.9 k	2.7 k	116	5.6 k	2.7 k
21	680	3.9 k	53	1.8 k	3.9 k	85	3.9 k	3.9 k	117	5.6 k	3.9 k
22	680	4.7 k	54	1.8 k	4.7 k	86	3.9 k	4.7 k	118	5.6 k	4.7 k
23	680	5.6 k	55*	1.8 k	5.6 k	87	3.9 k	5.6 k	119	5.6 k	5.6 k
24	680	6.8 k	56	1.8 k	6.8 k	88	3.9 k	6.8 k	120*	5.6 k	6.8 k
25	680	8.2 k	57	1.8 k	8.2 k	89	3.9 k	8.2 k	121*	5.6 k	8.2 k
26	680	10 k	58	1.8 k	10 k	90	3.9 k	10 k	122*	5.6 k	10 k
27	680	12 k	59	1.8 k	12 k	91	3.9 k	12 k	123*	5.6 k	12 k
28	680	15 k	60	1.8 k	15 k	92	3.9 k	15 k	124*	5.6 k	15 k
29	680	18 k	61	1.8 k	18 k	93	3.9 k	18 k	125*	5.6 k	18 k
30	680	22 k	62	1.8 k	22 k	94	3.9 k	22 k	126*	5.6 k	22 k
31	680	27 k	63	1.8 k	27 k	95	3.9 k	27 k	127*	5.6 k	27 k

Note: The addresses marked with an asterisk (\*) are reserved by the SMBus specification.

If only four devices are used in a system, their respective addresses can alternatively be configured without resistors by connecting the pins to GND or the AVDD18 pin. The PMBus™ addresses selectable in this fashion are listed in Table 4.3.

**Table 4.3 PMBus™ Address Selection without Resistors**

Address	ADDR1	ADDR0
15	GND	AVDD18
48	AVDD18	GND
63	AVDD18	AVDD18
64	GND	GND

#### 4.4. Configuration Registers

Two different sets of configuration parameters are supported by the ZSPM1025A. The first set of parameters can only be configured during the configuration phase of the ZSPM1025A. These values are written into the OTP memory and cannot be changed using PMBus™ commands during run-time. A second set of parameters can also be configured during run-time using the appropriate PMBus™ commands. The two groups are classified in the PMBus™ configuration table (Table 4.4).

**Table 4.4 List of Supported PMBus™ Configuration Registers**

Note: See important notes at the end of the table.

PMBus™ Parameter	Description	Data Format	Classification
<b>Output Voltage</b>			
ON_OFF_CONFIG	On/off configuration	N/A	PMBus™
VOUT_MODE	Exponent of the VOUT_COMMAND value	N/A	Read only
VOUT_COMMAND	Set output voltage	LINEAR <sup>(1)</sup>	PMBus™
VOUT_OV_FAULT_LIMIT	Over-voltage fault limit	N/A	OTP
VOUT_OV_WARN_LIMIT	Over-voltage warning level	N/A	OTP
VOUT_UV_WARN_LIMIT	Under-voltage warning level	N/A	OTP
VOUT_UV_FAULT_LIMIT	Under-voltage fault level	N/A	OTP
<b>Output Current</b>			
IOUT_OC_FAULT_LIMIT	Over-current fault limit	N/A	OTP
IOUT_OC_WARN_LIMIT	Over-current warning level	N/A	OTP
<b>Temperature – External</b>			
OT_FAULT_LIMIT	External over-temperature fault level	N/A	OTP
OT_WARN_LIMIT	External over-temperature warning level	N/A	OTP
<b>Temperature – Internal</b>			
IOT_FAULT_LIMIT	Internal over-temperature fault level	N/A	OTP
IOT_WARN_LIMIT	Internal over-temperature warning level	N/A	OTP

PMBus™ Parameter	Description	Data Format	Classification
<b>Input Voltage</b>			
VIN_OV_FAULT_LIMIT	Over-voltage fault limit	N/A	OTP
VIN_OV_WARN_LIMIT	Over-voltage warning level	N/A	OTP
VIN_UV_WARN_LIMIT	Under-voltage warning level	N/A	OTP
VIN_UV_FAULT_LIMIT	Under-voltage fault level	N/A	OTP
<b>Start-up Behavior / Power Sequencing</b>			
POWER_GOOD_ON	Power good on threshold	N/A	OTP
POWER_GOOD_OFF	Power good off threshold	N/A	OTP
<b>Output Voltage Sequencing</b>			
TON_DELAY	Turn-on delay	N/A	OTP
TON_RISE	Turn-on rise time	N/A	OTP
TON_FAULT_MAX	Turn-on maximum fault time	N/A	OTP
TOFF_DELAY	Turn-off delay	N/A	OTP
TOFF_FALL	Turn-off fall time	N/A	OTP
TOFF_WARN_MAX	Turn-off maximum warning time	N/A	OTP
VOFF_NOM	Soft-stop off value	N/A	OTP
Notes:			
1. VOUT_MODE is read-only for this device.			

The ZSPM1025A supports the LINEAR data format according to the PMBus™ specification. Note that in accordance with the PMBus™ specification, all commands related to the output voltage are subject to the VOUT\_MODE settings. Note that VOUT\_MODE is read-only for the ZSPM1025A.



## 4.5. Monitoring

The ZSPM1025A has a dedicated set of PMBus™ registers to enable advanced power management using extensive monitoring features. Different warning and error flags can be read by the PMBus™ master to ensure proper operation of the power converter or monitor the converters over the product lifetime.

**Table 4.5 List of Supported PMBus™ Status Registers**

PMBus™ Command	Description	Data Format
CLEAR_FAULTS	Clear status information	
STATUS_BYTE	Unit status byte	
STATUS_WORD	Unit status word	
STATUS_VOUT	Output voltage status	
STATUS_IOUT	Output current status	
STATUS_INPUT	Input status	
STATUS_TEMPERATURE	Temperature status	
STATUS_CML	Communication and memory status	
READ_VIN	Input voltage read back	LINEAR
READ_VOUT	Output voltage read back	LINEAR
READ_IOUT	Output current read back	LINEAR
READ_TEMPERATURE_1	External temperature read back	LINEAR
READ_TEMPERATURE_2	Internal temperature read back	LINEAR

## 4.6. Additional Registers

**Table 4.6 Additional Supported PMBus™ Registers**

PMBus™ Command	Description	Data Length (Byte)	Values
PMBUS_REVISION	PMBus™ revision	1	11 <sub>HEX</sub>
MFR_ID	Manufacturer ID	4	“ZMDI” (5A <sub>HEX</sub> , 4D <sub>HEX</sub> , 44 <sub>HEX</sub> , 49 <sub>HEX</sub> )
MFR_MODEL	Manufacturer model identifier	4	“1025” (31 <sub>HEX</sub> , 30 <sub>HEX</sub> , 32 <sub>HEX</sub> , 35 <sub>HEX</sub> )
MFR_REVISION	Manufacturer product revision	4	
MFR_SERIAL	Serial number	12	

## 4.7. Detailed Description of the Supported PMBus™ Commands

### 4.7.1. OPERATION

The OPERATION command is used to turn the unit on and off in conjunction with the input from the CONTROL pin. The unit stays in the commanded operating mode until a subsequent OPERATION command or change in the state of the CONTROL pin instructs the device to change to another mode. The supported operation modes are listed in Table 4.7.

**Table 4.7 Supported PMBus™ Operation Modes**

OPERATION (read/write)					
Bits[7:6]	Bits[5:4]	Bits[3:2]	Bits[1:0]	Unit On or Off	Margin State
01	XX	XX	XX	Soft Off (With Sequencing)	N/A
10	00	XX	XX	On	Off

### 4.7.2. ON\_OFF\_CONFIG

The ON\_OFF\_CONFIG command is used to configure the combination of the CONTROL pin and the PMBus™ OPERATION command that turns the unit on or off. The supported configuration options are listed in Table 4.8.

**Table 4.8 Supported PMBus™ ON\_OFF\_CONFIG Options**

ON_OFF_CONFIG (read/write)		
Bits	Name	Description
[0]	CONTROL OFF	Value ignored. Device always uses the programmed turn off delay and fall time.
[1]	CONTROL Polarity	0: Active low (pull pin low to start the unit). 1: Active high (pull pin high to start the unit).
[2]	CONTROL Enable	0: Unit ignores the CONTROL pin. 1: Unit requires the CONTROL pin to be asserted to start the unit.*
[3]	OPERATION Enable	0: Unit ignores the on/off settings in the OPERATION command. 1: Unit requires the on/off settings in the OPERATION command to start the unit*.

\*Depending on the configuration, both conditions must be in the on state in order to turn on the unit.

### 4.7.3. CLEAR\_FAULTS

The CLEAR\_FAULTS command is used to clear any fault bits that have been set in the status registers. Additionally, the SMBALERT signal is cleared if it was previously asserted. Note that the device resumes operation with the currently configured state after a CLEAR\_FAULTS command has been issued. If a fault/warning is still present, the respective bit is set immediately again.

#### 4.7.4. VOUT\_MODE

The VOUT\_MODE command is used to retrieve information about the data format for all output voltage related commands. Note that this is a read-only value.

VOUT_MODE (read only)		
Bits	Name	Description
[4:0]	PARAMETER	2's complement of the exponent
[7:5]	MODE	000: Linear data format

#### 4.7.5. VOUT\_COMMAND

The VOUT\_COMMAND is used to set the output voltage during run-time.

Note that the maximum output voltage is 3.6V.

VOUT_COMMAND (read/write)		
Bits	Name	Description
[15:0]	MANTISSA	Unsigned mantissa of output voltage in V. Exponent can be retrieved via VOUT_MODE command.

#### 4.7.6. STATUS\_BYTE

The STATUS\_BYTE command returns a summary of the most critical faults in one byte.

STATUS_BYTE (read only)		
Bits	Name	Description
[0]	NONE OF THE ABOVE	A fault not listed in bits [7:1] has occurred.
[1]	CML	A communication fault as occurred.
[2]	TEMPERATURE	A temperature fault or warning has occurred.
[3]	VIN_UV	An input under-voltage fault has occurred.
[4]	IOUT_OC	An output over-current fault has occurred.
[5]	VOUT_OV	An output over-voltage fault has occurred.
[6]	OFF	This bit is asserted if the unit is not providing power to the output, regardless of the reason, including simply not being enabled.
[7]	BUSY	Not supported.

#### 4.7.7. STATUS\_WORD

The STATUS\_WORD command returns a summary of the device status information in two data bytes.

STATUS_WORD (read only)		
Bits	Name	Description
[7:0]	STATUS_BYTE	See status byte (section 4.7.6).
[8]	UNKNOWN	Not supported
[9]	OTHER	Not supported
[10]	FANS	No supported
[11]	POWER_GOOD#	The POWER_GOOD signal, if present, is negated.
[12]	MFR	A manufacturer-specific fault or warning has occurred.
[13]	INPUT	An input-related warning or fault has occurred.
[14]	IOUT/POUT	An output current or output power warning or fault has occurred.
[15]	VOUT	An output-voltage-related warning or fault has occurred.

#### 4.7.8. STATUS\_VOUT

STATUS_VOUT (read only)		
Bits	Name	Description
[0]		Not supported.
[1]		Not supported.
[2]		Not supported.
[3]		Not supported.
[4]	VOUT_UV_FLT	An output voltage under-voltage fault has occurred.
[5]	VOUT_UV_WARN	An output voltage under-voltage warning has occurred.
[6]	VOUT_OV_WARN	An output voltage over-voltage warning has occurred.
[7]	VOUT_OV_FLT	An output voltage over-voltage fault has occurred.

#### 4.7.9. STATUS\_IOUT

STATUS_IOUT (read only)		
Bits	Name	Description
[0]		Not supported.
[1]		Not supported.
[2]		Not supported.
[3]		Not supported.
[4]		Not supported.
[5]	IOUT_OC_WARN	An over-current warning has occurred.
[6]		Not supported.
[7]	IOUT_OC_FLT	An over-current fault has occurred.

#### 4.7.10. STATUS\_INPUT

STATUS_INPUT (read only)		
Bits	Name	Description
[0]		Not supported.
[1]		Not supported.
[2]		Not supported.
[3]		Not supported.
[4]	VIN_UV_FLT	An input voltage under-voltage fault has occurred.
[5]	VIN_UV_WARN	An input voltage under-voltage warning has occurred.
[6]	VIN_OV_WARN	An input voltage over-voltage warning has occurred.
[7]	VIN_OV_FLT	An input voltage over-voltage fault has occurred.

#### 4.7.11. STATUS\_TEMPERATURE

STATUS_TEMPERATURE (read only)		
Bits	Name	Description
[0]		Not supported.
[1]		Not supported.
[2]		Not supported.
[3]		Not supported.
[4]		Not supported.
[5]		Not supported.
[6]	TEMP_OV_WARN	An (external) over-temperature warning has occurred.
[7]	TEMP_OV_FLT	An (external) over-temperature fault has occurred.

#### 4.7.12. STATUS\_CML

STATUS_CML (read only)		
Bits	Name	Description
[0]		Not supported.
[1]	SMBUS_FLT	SMBus™ timeout or a format error has occurred.
[2]		Not supported.
[3]		Not supported.
[4]		Not supported.
[5]	PEC_FLT	A packet error check fault has occurred.
[6]		Not supported.
[7]	CMD_FLT	An invalid or an unsupported command has been received.

#### 4.7.13. STATUS\_MFR\_SPECIFIC

STATUS_MFR_SPECIFIC (read only)		
Bits	Name	Description
[0]		Not supported.
[1]		Not supported.
[2]		Not supported.
[3]		Not supported.
[4]		Not supported.
[5]		Not supported.
[6]	ITEMP_OV_WARN	An (internal) over-temperature warning has occurred.
[7]	ITEMP_OV_FLT	An (internal) over-temperature fault has occurred.

#### 4.7.14. READ\_VIN

READ_VIN (read only)		
Bits	Name	Description
[15:0]	VIN	Input voltage in V (linear data format).

#### 4.7.15. READ\_VOUT

READ_VOUT (read only)		
Bits	Name	Description
[15:0]	VOUT	Output voltage in V (linear data format). Note that this command is mantissa only.

#### 4.7.16. READ\_IOUT

READ_IOUT (read only)		
Bits	Name	Description
[15:0]	IOUT	Output current in A (linear data format).

#### 4.7.17. READ\_TEMPERATURE1

READ_TEMPERATURE1 (read only)		
Bits	Name	Description
[15:0]	TEMP1	External temperature in °C (linear data format).

#### 4.7.18. READ\_TEMPERATURE2

READ_TEMPERATURE2 (read only)		
Bits	Name	Description
[15:0]	TEMP2	Internal temperature in °C (linear data format).





**Table 5.1** *Passive Component Values for the Application Circuit*

Reference Designator	Component Value	Description
C1	1.0 $\mu$ F	Ceramic capacitor.
C2	4.7 $\mu$ F	Ceramic capacitor. Recommended 4.7 $\mu$ F, Minimum 1.0 $\mu$ F.
C3	4.7 $\mu$ F	Ceramic capacitor. Recommended 4.7 $\mu$ F, Minimum 1.0 $\mu$ F.
C4	4.7 $\mu$ F	Ceramic capacitor. Recommended 4.7 $\mu$ F, Minimum 1.0 $\mu$ F.
C5	4.7 $\mu$ F	Ceramic capacitor. Recommended 4.7 $\mu$ F, Minimum 1.0 $\mu$ F.
C6	100nF	
C7	22pF	Output voltage sense filtering capacitor. Recommended 22pF, maximum 1 nF.
C8	220nF*	DCR current-sense filter capacitor.
CIN		Input filter capacitors. Can be a combination of ceramic and electrolytic capacitors.
COUT		Output filter capacitors. See section 5.1.2 for more information on the output capacitor selection.
R1	51 $\Omega$ *	
R2, R3		Select PMBus™ address resistor value from Table 4.2.
R4	1.0k $\Omega$ *	Output voltage divider bottom resistor. Connect between the VFBP and VFBN pins. Populate R4 only if the output voltage range is from 1.20V to 3.60V. Do not populate R4 if the output voltage is below 1.20V. See section 5.1.1.
R5	1.74k $\Omega$ *	Output voltage divider top resistor. Connect between the output terminal and the VFBP pin.
R6	2.15k $\Omega$ *	DCR current sense filter resistor.
R7	9.1k $\Omega$ *	Input voltage divider top resistor. Connect between the main power input and the VIN pin of the ZSPM1025A.
R8	1.0k $\Omega$ *	Input voltage divider bottom resistor. Connect between the VIN and AGND pins of the ZSPM1025A.
R9, R10	15k $\Omega$ *	PMBus™ SCL and SDA line pull-up resistors. The pull-up resistors can be tied to 3.3V or 5V depending on the supply voltage of the PMBus™ master.

\* Values marked with an asterisk are fixed component values that must not be changed.

### 5.1.1. Output Voltage Selection

The ZSPM1025A can be configured to operate within two output voltage ranges (see Table 5.2). If the required output voltage is within range #1 resistor R4 should not be placed on the application board. For output voltages within range #2, resistor R4 should be placed on the application board.

**Table 5.2 Output Voltage Ranges**

Output voltage Range	Minimum VOUT	Maximum VOUT
#1	0.35V	1.20V
#2	1.20V	3.60V

### 5.1.2. Output Capacitor Selection

The ZSPM1025A Digital PWM controller can be configured to operate over a wide range of output capacitance. Four ranges of output capacitance have been specified to match typical customer requirements (see Table 5.3).

Typical performance measurements for both load transient performance and open-loop Bode plots can be found in section 5.2. Using less output capacitance than the minimum capacitance given in Table 5.3 is not recommended.

**Table 5.3 Recommended Output Capacitor Ranges**

Capacitor Range	Ceramic Capacitor	Bulk Electrolytic Capacitors
#1	Minimum 200 $\mu$ F Maximum 400 $\mu$ F	None
#2	Minimum 400 $\mu$ F Maximum 1000 $\mu$ F	None
#3	Minimum 100 $\mu$ F Maximum 600 $\mu$ F	Minimum 2 x 470 $\mu$ F, 7m $\Omega$ ESR Maximum 5 x 470 $\mu$ F, 7m $\Omega$ ESR
#4	Minimum 400 $\mu$ F Maximum 1000 $\mu$ F	Minimum 4 x 470 $\mu$ F, 7m $\Omega$ ESR Maximum 10 x 470 $\mu$ F, 7m $\Omega$ ESR

## 5.2. Typical Performance Measurements for the ZSPM1025A

IDT has designed eight sets of compensation loop parameters for the ZSPM1025A. The compensation loop parameters have been designed for each of the two output-voltage ranges (see Table 5.2) in combination with one of the four ranges of output capacitors (see Table 5.3). The Pink Power Designer™ GUI wizard can guide the user through a selection process and load the correct set of parameters for the selected output voltage and output capacitor range. Please see the *Pink Power Designer™ GUI User Guide* for more information on the wizard.

Load transient performance measurements and open loop Bode plots for the eight configurations can be found in sections 5.2.1 to 5.2.8. The transient load steps have been generated with a load resistor and a power MOSFET located on the same circuit board as the ZSPM1025A and the Murata OKLP-X/25-W12-C Power Block.

The ZSPM8025 Evaluation Kit can be used to further evaluate the performance of the ZSPM1025A for the four capacitor ranges.

### 5.2.1. Typical Load Transient Response – Capacitor Range #1 – VOUT Range #1

Test conditions:  $V_{IN} = 12.0V$ ,  $V_{OUT} = 1.20V$

Minimum output capacitance:  $2 \times 100\mu F/6.3V \times 5R$

Maximum output capacitance:  $3 \times 100\mu F/6.3V \times 5R + 2 \times 47\mu F/10V \times 7R$

**Figure 5.2 5 to 15A Load Step – Min. Capacitance**

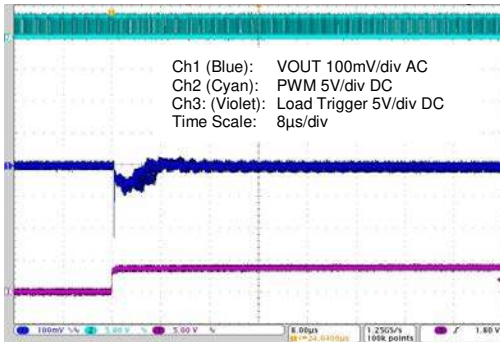

**Figure 5.3 15 to 5A Load Step – Min. Capacitance**

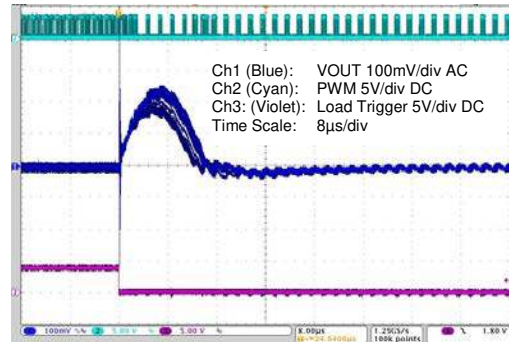

**Figure 5.4 5 to 15A Load Step – Max. Capacitance**

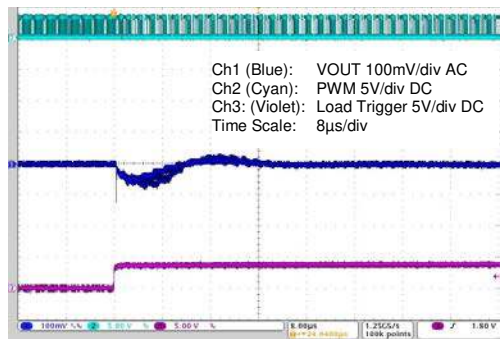

**Figure 5.5 15 to 5A Load Step – Max. Capacitance**

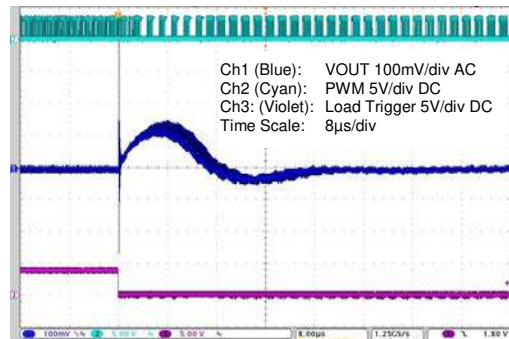

**Figure 5.6 Open Loop Bode Plots**

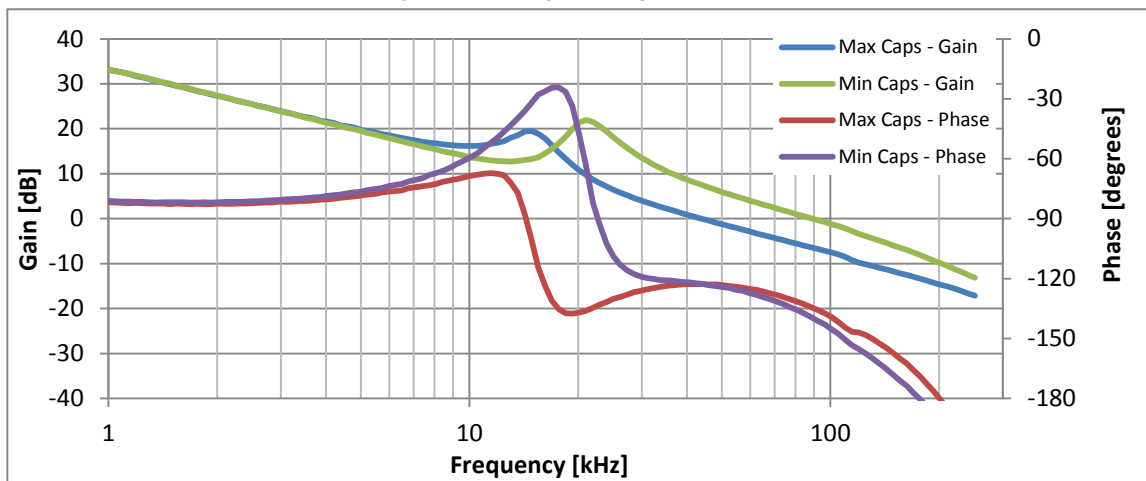

**5.2.2. Typical Load Transient Response – Capacitor Range #2 – VOUT Range #1**

Test conditions:  $V_{IN} = 12.0V$ ,  $V_{OUT} = 1.20V$

Minimum output capacitance:  $3 \times 100\mu F/6.3V \text{ X5R} + 2 \times 47\mu F/10V \text{ X7R}$

Maximum output capacitance:  $7 \times 100\mu F/6.3V \text{ X5R} + 4 \times 47\mu F/10V \text{ X7R}$

**Figure 5.7 5 to 15A Load Step – Min. Capacitance**

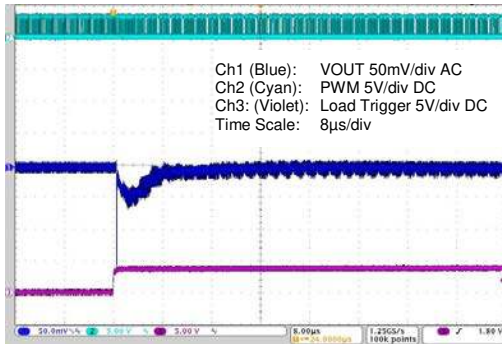

**Figure 5.8 15 to 5A Load Step – Min. Capacitance**

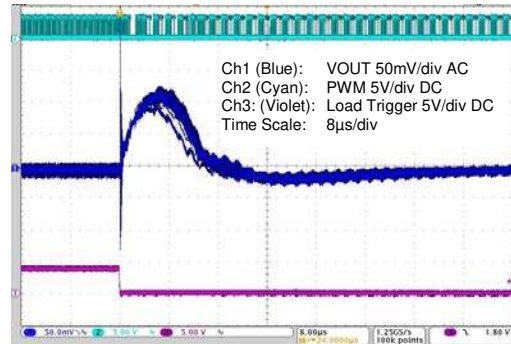

**Figure 5.9 5 to 15A Load Step – Max. Capacitance**

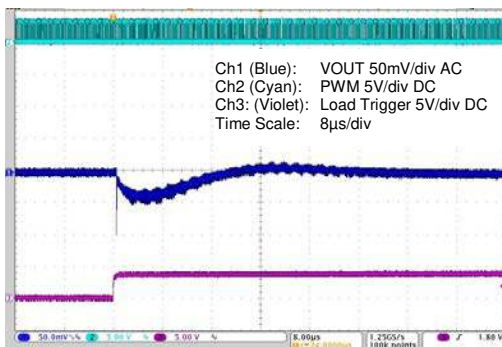

**Figure 5.10 15 to 5A Load Step – Min. Capacitance**

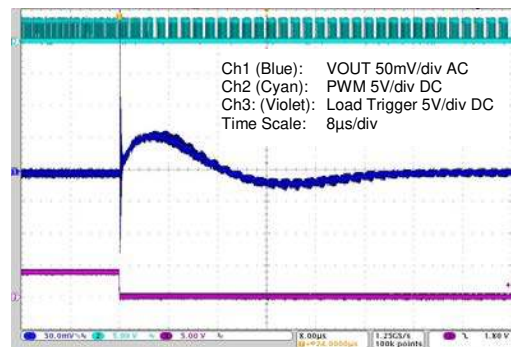

**Figure 5.11 Open Loop Bode Plots**

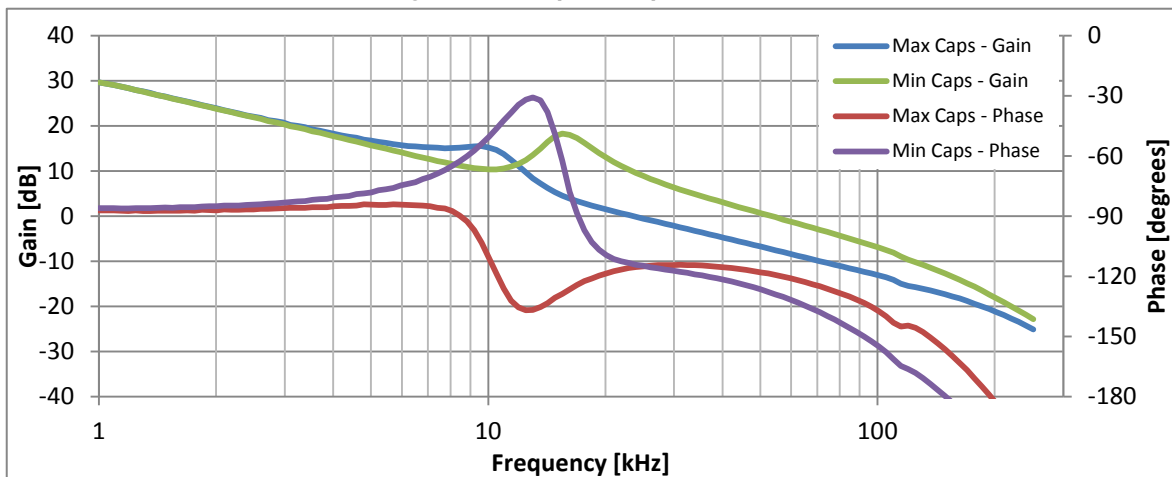

### 5.2.3. Typical Load Transient Response – Capacitor Range #3 – VOUT Range #1

Test conditions:  $V_{IN} = 12.0V$ ,  $V_{OUT} = 1.20V$

Minimum output capacitance:  $1 \times 100\mu F/6.3V \text{ X5R} + 2 \times 470 \mu F/6.3V/7m\Omega$  Aluminum Electrolytic Capacitor

Maximum output capacitance:  $6 \times 100 \mu F/6.3V \text{ X5R} + 5 \times 470 \mu F/6.3V/7m\Omega$  Aluminum Electrolytic Capacitor

**Figure 5.12 5 to 15A Load Step – Min. Capacitance**

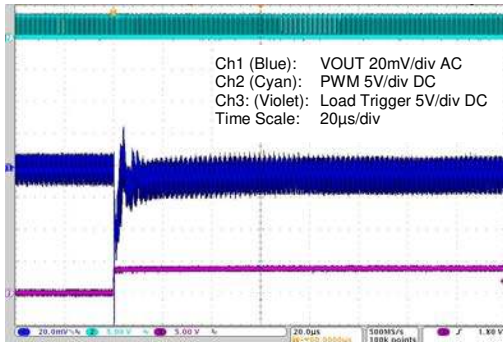

**Figure 5.13 15 to 5A Load Step – Min. Capacitance**

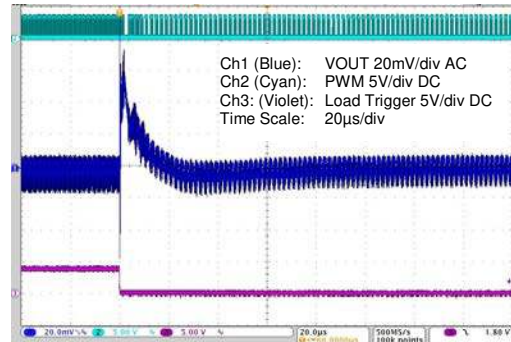

**Figure 5.14 5 to 15A Load Step – Max. Capacitance**

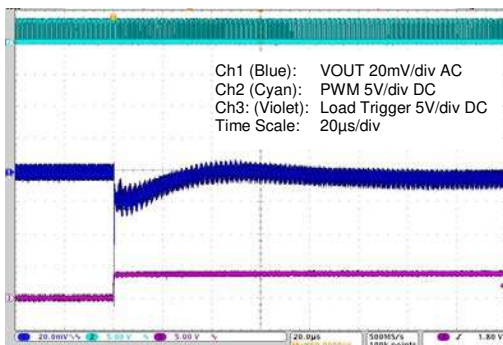

**Figure 5.15 15 to 5A Load Step – Max. Capacitance**

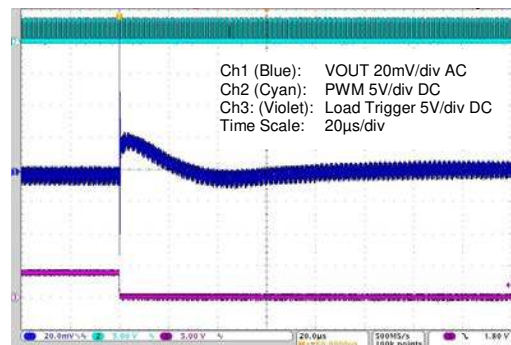

**Figure 5.16 Open Loop Bode Plots**

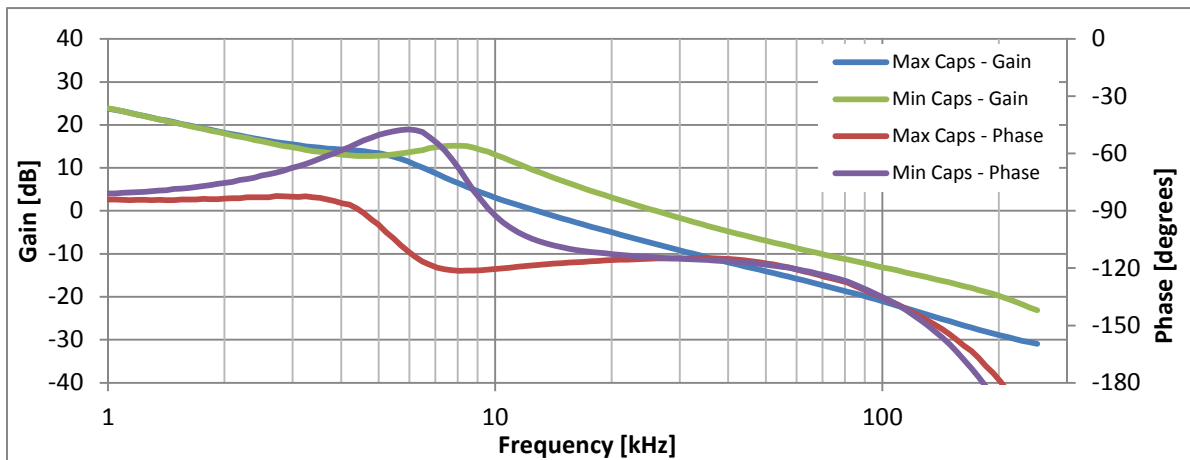

### 5.2.4. Typical Load Transient Response – Capacitor Range #4 – VOUT Range #1

Test conditions:  $V_{IN} = 12.0V$ ,  $V_{OUT} = 1.20V$

Minimum output capacitance:  $3 \times 100\mu F/6.3V \text{ X5R} + 2 \times 47\mu F/10V \text{ X7R} + 4 \times 470 \mu F/6.3V/7m\Omega$  Aluminum Electrolytic Capacitor

Maximum output capacitance:  $7 \times 100 \mu F/6.3V \text{ X5R} + 4 \times 47\mu F/10V \text{ X7R} + 10 \times 470 \mu F/6.3V/7m\Omega$  Aluminum Electrolytic Capacitor

**Figure 5.17 5 to 15A Load Step – Min. Capacitance**

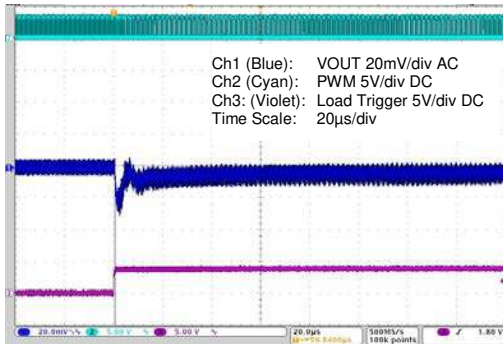

**Figure 5.18 15 to 5A Load Step – Min. Capacitance**

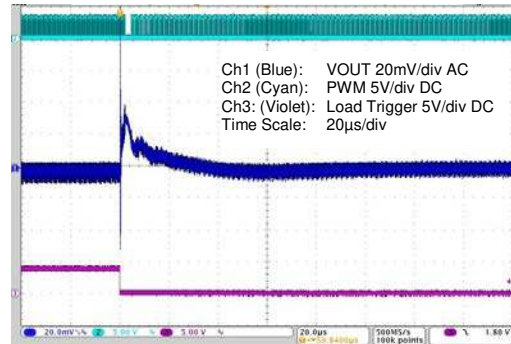

**Figure 5.19 5 to 15A Load Step – Max. Capacitance**

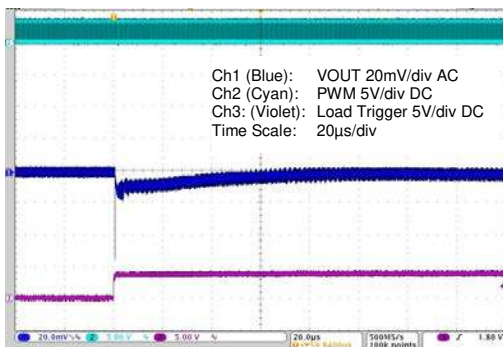

**Figure 5.20 15 to 5A Load Step – Max. Capacitance**

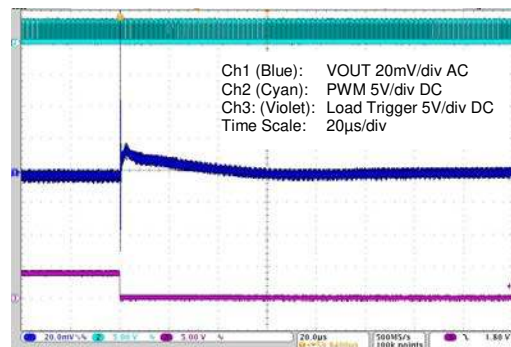

**Figure 5.21 Open Loop Bode Plots**

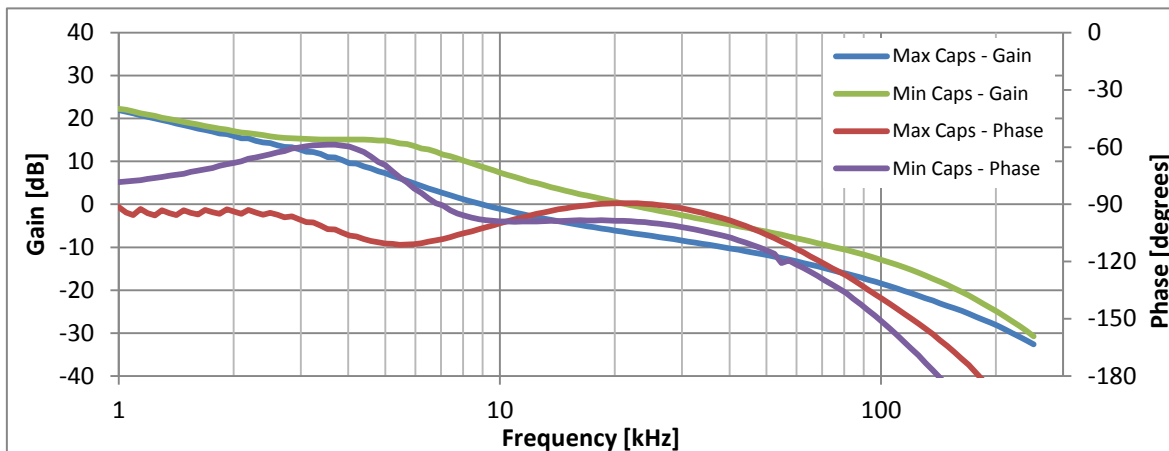

### 5.2.5. Typical Load Transient Response – Capacitor Range #1 – VOUT Range #2

Test conditions:  $V_{IN} = 12.0V$ ,  $V_{OUT} = 1.80V$

Minimum output capacitance:  $2 \times 100\mu F/6.3V \text{ X5R}$

Maximum output capacitance:  $3 \times 100\mu F/6.3V \text{ X5R} + 2 \times 47\mu F/10V \text{ X7R}$

**Figure 5.22 5 to 20A Load Step – Min. Capacitance**

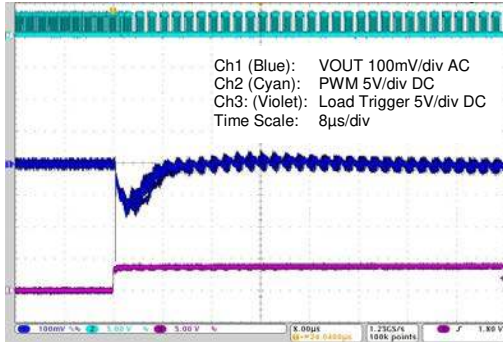

**Figure 5.23 20 to 5A Load Step – Min. Capacitance**

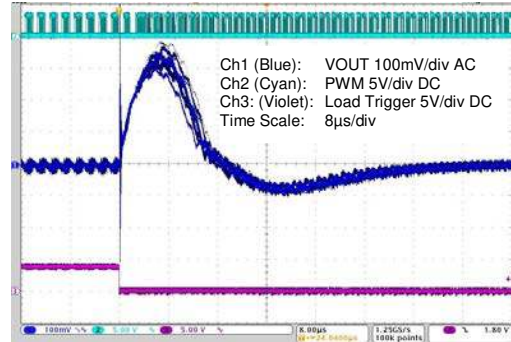

**Figure 5.24 5 to 20A Load Step – Max. Capacitance**

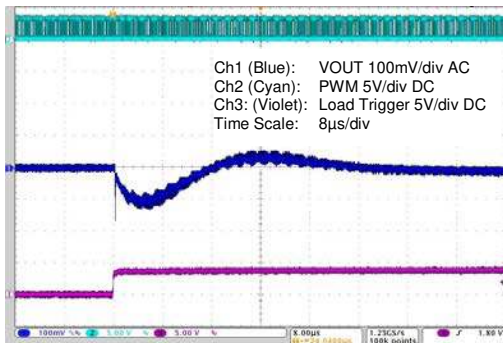

**Figure 5.25 20 to 5A Load Step – Max. Capacitance**

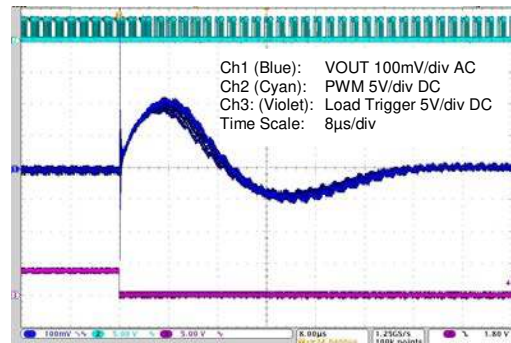

**Figure 5.26 Open Loop Bode Plots**

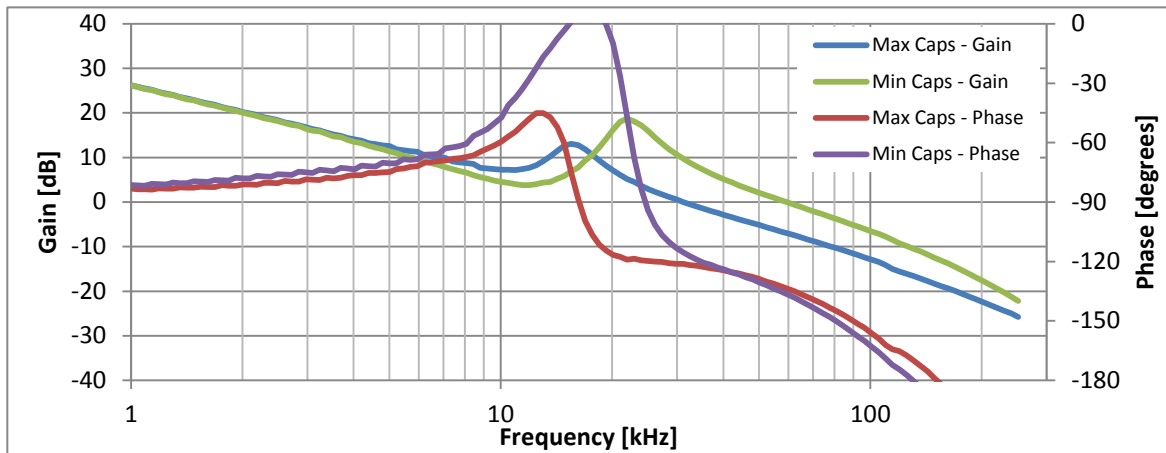

### 5.2.6. Typical Load Transient Response – Capacitor Range #2 – VOUT Range #2

Test conditions:  $V_{IN} = 12.0V$ ,  $V_{OUT} = 1.80V$

Minimum output capacitance:  $3 \times 100\mu F/6.3V \text{ X5R} + 2 \times 47\mu F/10V \text{ X7R}$

Maximum output capacitance:  $7 \times 100\mu F/6.3V \text{ X5R} + 4 \times 47\mu F/10V \text{ X7R}$

**Figure 5.27 5 to 20A Load Step – Min. Capacitance**

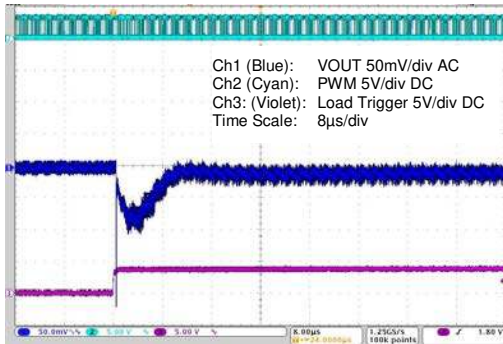

**Figure 5.28 20 to 5A Load Step – Min. Capacitance**

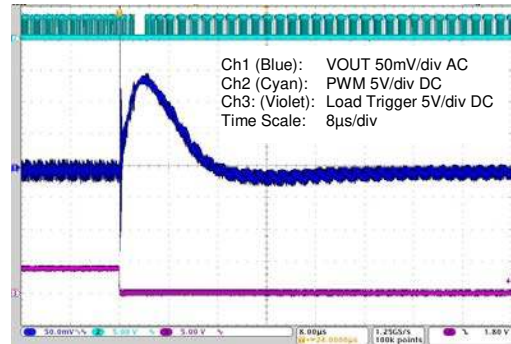

**Figure 5.29 5 to 20A Load Step – Max. Capacitance**

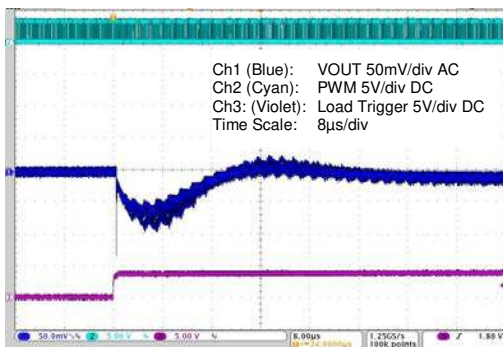

**Figure 5.30 20 to 5A Load Step – Max. Capacitance**

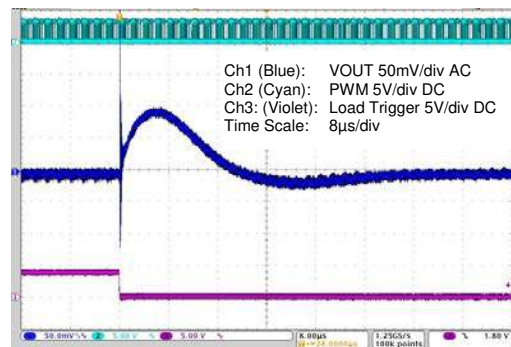

**Figure 5.31 Open Loop Bode Plots**

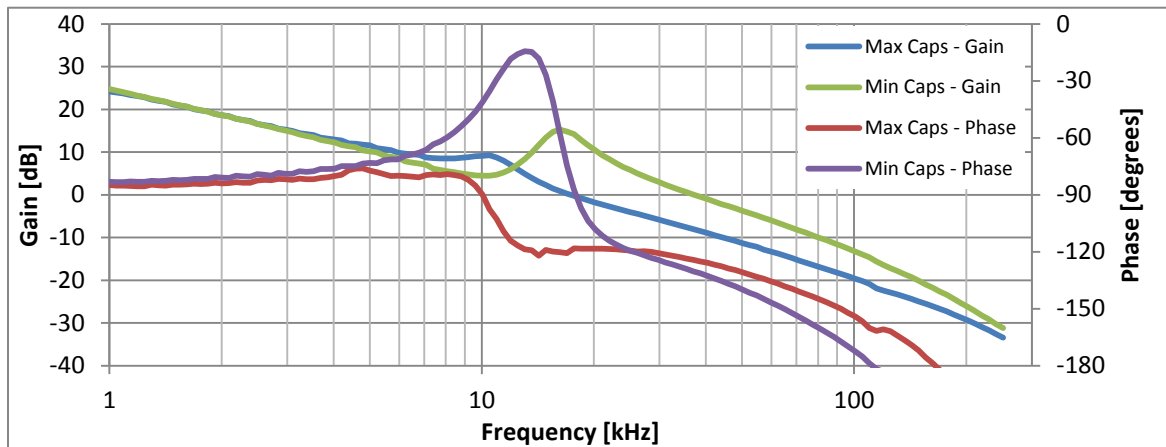



**5.2.7. Typical Load Transient Response – Capacitor Range #3 – VOUT Range #2**

Test conditions:  $V_{IN} = 12.0V$ ,  $V_{OUT} = 1.80V$

Minimum output capacitance:  $1 \times 100\mu F/6.3V \text{ X5R} + 2 \times 470 \mu F/6.3V/7m\Omega$  Aluminum Electrolytic Capacitor

Maximum output capacitance:  $6 \times 100 \mu F/6.3V \text{ X5R} + 5 \times 470 \mu F/6.3V/7m\Omega$  Aluminum Electrolytic Capacitor

**Figure 5.32 5 to 20A Load Step – Min. Capacitance**

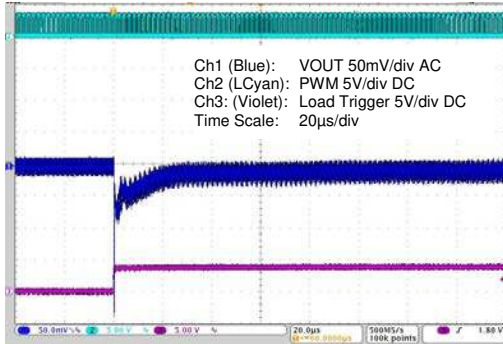

**Figure 5.33 20 to 5A Load Step – Min. Capacitance**

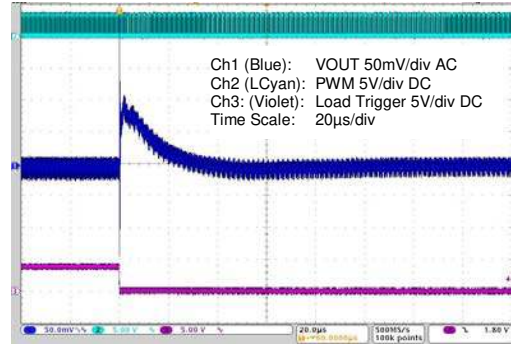

**Figure 5.34 5 to 20A Load Step – Max. Capacitance**

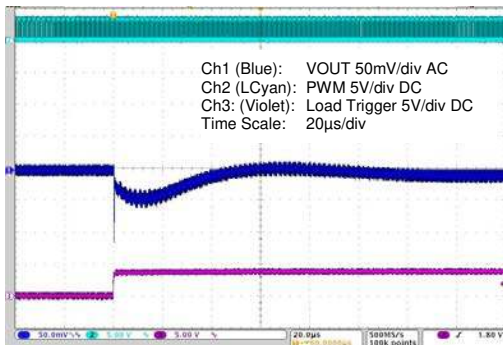

**Figure 5.35 20 to 5A Load Step – Max. Capacitance**

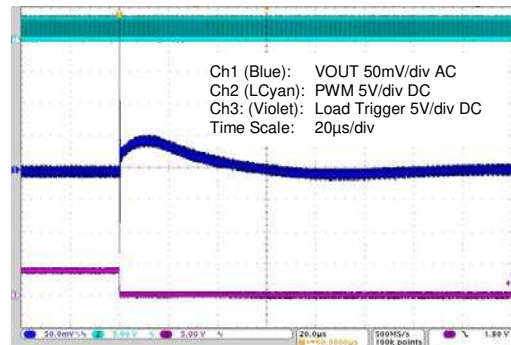

**Figure 5.36 Open Loop Bode Plots**

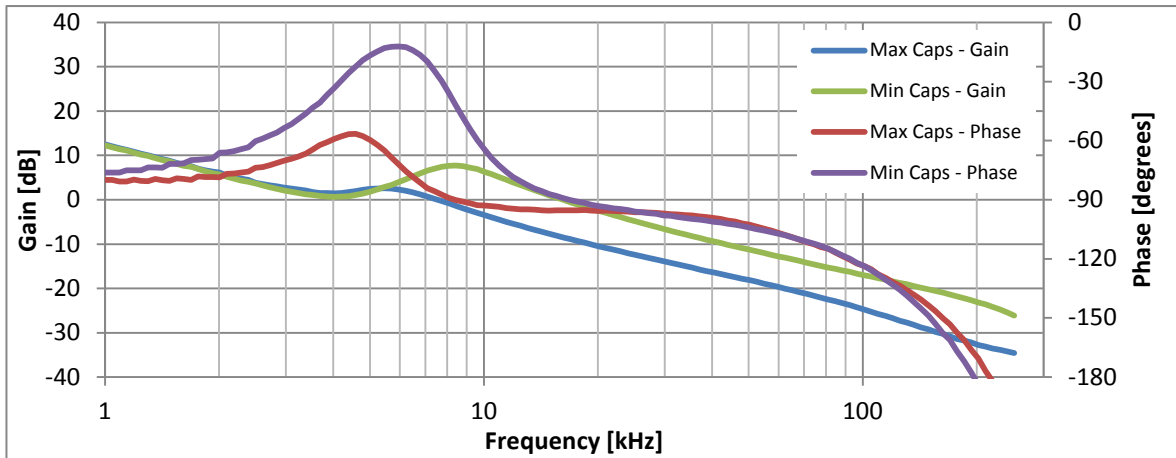

### 5.2.8. Typical Load Transient Response – Capacitor Range #4 – VOUT Range #2

Test conditions:  $V_{IN} = 12.0V$ ,  $V_{OUT} = 1.80V$

Minimum output capacitance: 3 x 100 $\mu$ F/6.3V X5R + 2 x 47 $\mu$ F/10V X7R + 4 x 470  $\mu$ F/6.3V/7m $\Omega$  Aluminum Electrolytic Capacitor

Maximum output capacitance: 7 x 100  $\mu$ F/6.3V X5R + 4 x 47 $\mu$ F/10V X7R + 10 x 470  $\mu$ F/6.3V/7m $\Omega$  Aluminum Electrolytic Capacitor

**Figure 5.37 5 to 20A Load Step – Min. Capacitance**

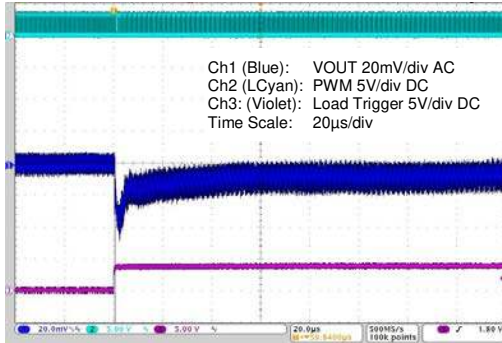

**Figure 5.38 20 to 5A Load Step – Min. Capacitance**

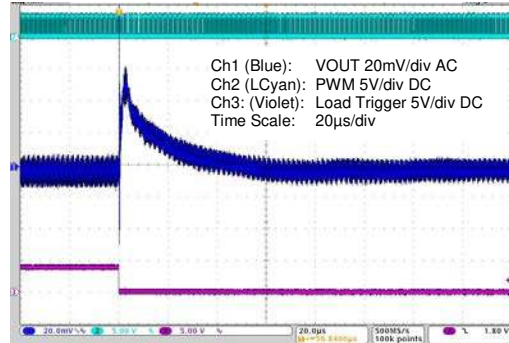

**Figure 5.39 5 to 20A Load Step – Max. Capacitance**

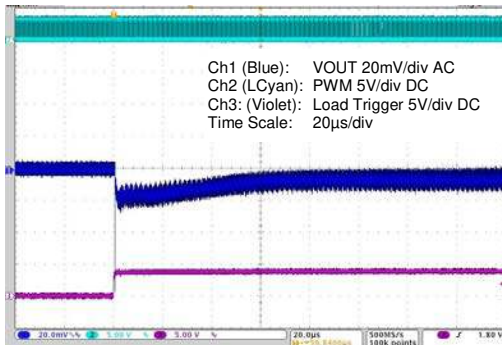

**Figure 5.40 20 to 5A Load Step – Max. Capacitance**

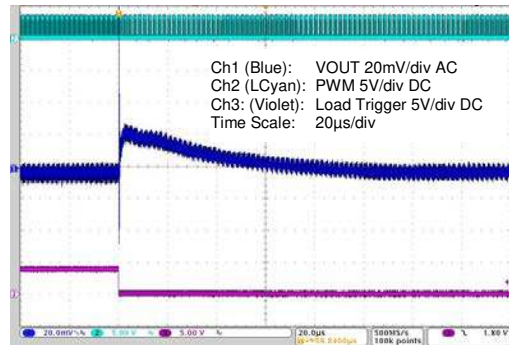

**Figure 5.41 Open Loop Bode Plots**

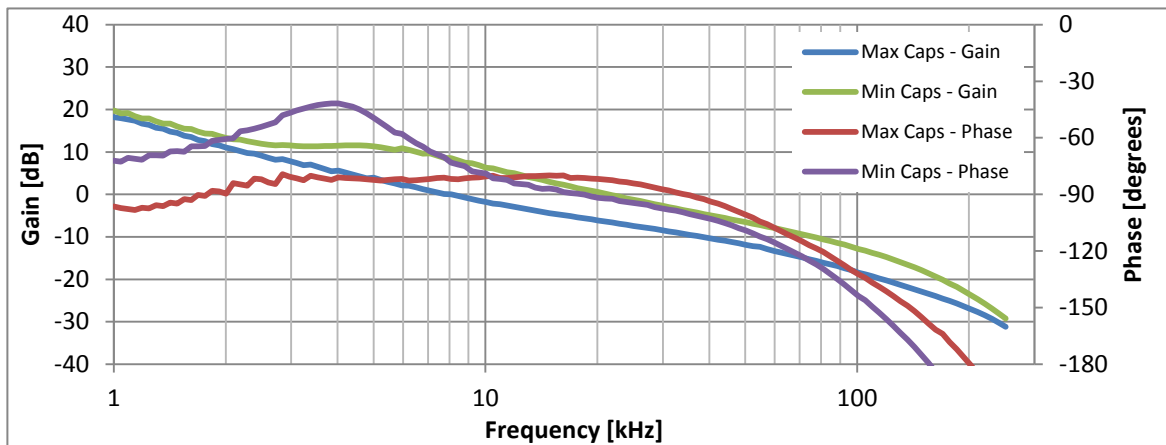

## 6 Mechanical Specifications

Based on JEDEC MO-220. All dimensions are in millimeters.

Figure 6.1 Package Drawing

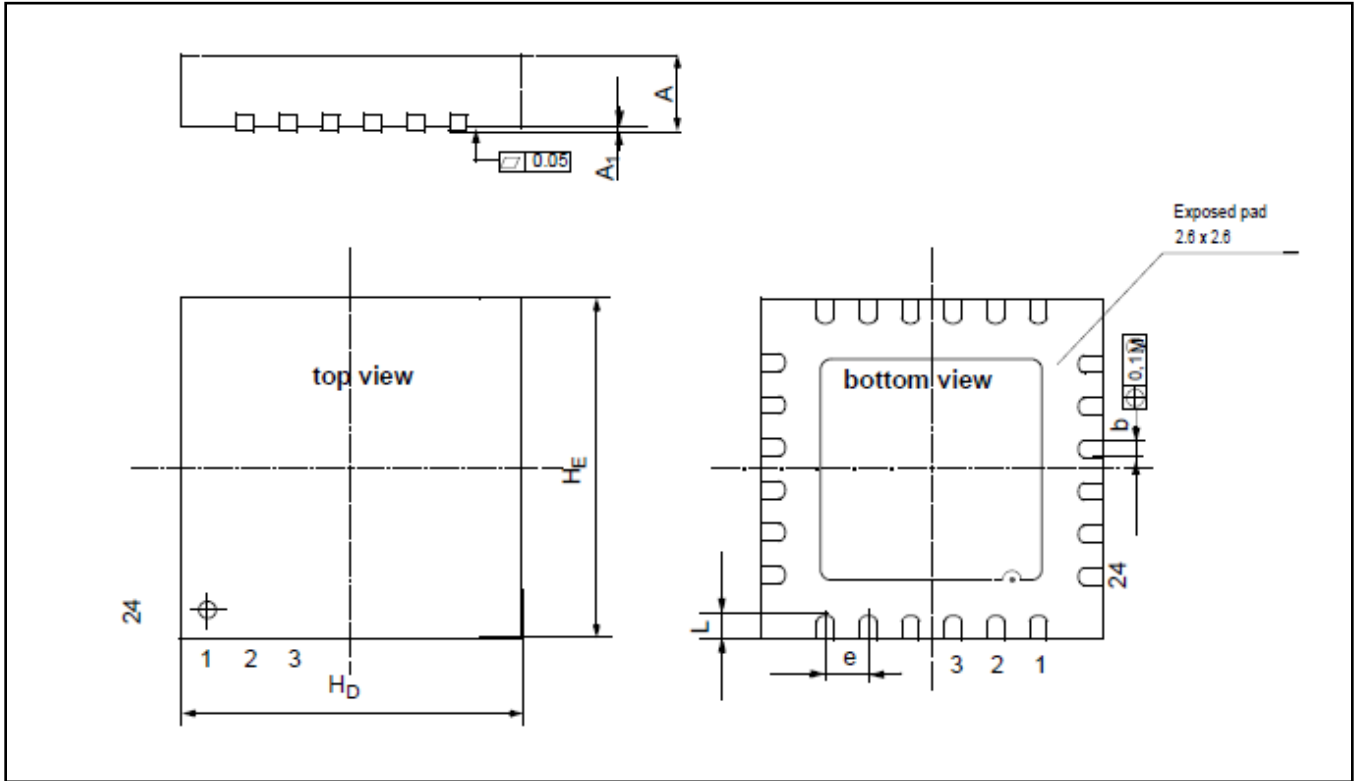

Dimensions [mm]	Min	Max
A	0.8	0.90
A <sub>1</sub>	0.00	0.05
b	0.18	0.30
e	0.5 nominal	
H <sub>D</sub>	3.90	4.1
H <sub>E</sub>	3.90	4.1
L	0.35	0.45

## 7 Ordering Information

This product is sold under a limited license from PowerOne, Inc. related to digital power technology as set forth in U.S. Patent 7000125 and other related patents owned by PowerOne, Inc. This license does not extend to stand-alone power supply products.

Sales Code	Description	Package
ZSPM1025AA1W 1	ZSPM1025A Lead-free QFN24 — Temperature range: -40°C to +125°C	Reel
ZSPM8025-KIT	Evaluation Kit for ZSPM1025A with PMBus™ Communication Interface — Pink Power Designer™ GUI for kit can be downloaded from the IDT web site at <a href="http://www.IDT.com/ZSPM1025A">www.IDT.com/ZSPM1025A</a>	Kit

## 8 Related Documents

Document
<i>ZSPM8025A Feature Sheet</i>
<i>ZSPM8025-KIT Evaluation Kit Description</i>
<i>Pink Power Designer™ Graphic User Interface (GUI)</i>
<i>ZSPM10x5A Application Note—Programming and Calibration</i>

Visit the ZSPM1025A product page ([www.IDT.com/ZSPM1025A](http://www.IDT.com/ZSPM1025A)) or contact your nearest sales office for the latest version of these documents.

## 9 Glossary

Term	Description
ASIC	Application Specific Integrated Circuit
DPWM	Digital Pulse-Width Modulator
DCR	DC Resistance
DSP	Digital Signal Processing
FET	Field-Effect Transistor
FPGA	Field-Programmable Gate Array
GPIO	General Purpose Input/Output
GUI	Graphical User Interface
HKADC	Housekeeping Analog-To-Digital Converter
NVM	Non-volatile Memory
OT	Over-Temperature
OTP	One-Time Programmable Memory

Term	Description
OV	Over-Voltage
PEC	Packet Error Correction
PID	Proportional/Integral/Derivative
POR	Power-On-Reset
SCR	Sub-cycle Response™
SLC	State-Law Control™
SPM	Smart Power Management

## 10 Document Revision History

Revision	Date	Description
1.00	October 25, 2013	First release.
1.10	January 16, 2014	Addition of description of reference solution on page 2. Revision for kit contents: GUI is now downloaded from the product web page. Correction for the hexadecimal code for the ZSPM1025 for the MFR_MODEL register in Table 4.6. Update for glossary.
1.20	February 5, 2014	Correction for page 2: ZSPM1025A supports continuous retry (“hiccup”) mode. Update for imagery for cover and headers.
1.21	October 15, 2014	Addition of information about PowerOne, Inc. license. Update for contact information.
	January 25, 2016	Changed to IDT branding.

## IMPORTANT NOTICE AND DISCLAIMER

RENESAS ELECTRONICS CORPORATION AND ITS SUBSIDIARIES (“RENESAS”) PROVIDES TECHNICAL SPECIFICATIONS AND RELIABILITY DATA (INCLUDING DATASHEETS), DESIGN RESOURCES (INCLUDING REFERENCE DESIGNS), APPLICATION OR OTHER DESIGN ADVICE, WEB TOOLS, SAFETY INFORMATION, AND OTHER RESOURCES “AS IS” AND WITH ALL FAULTS, AND DISCLAIMS ALL WARRANTIES, EXPRESS OR IMPLIED, INCLUDING, WITHOUT LIMITATION, ANY IMPLIED WARRANTIES OF MERCHANTABILITY, FITNESS FOR A PARTICULAR PURPOSE, OR NON-INFRINGEMENT OF THIRD PARTY INTELLECTUAL PROPERTY RIGHTS.

These resources are intended for developers skilled in the art designing with Renesas products. You are solely responsible for (1) selecting the appropriate products for your application, (2) designing, validating, and testing your application, and (3) ensuring your application meets applicable standards, and any other safety, security, or other requirements. These resources are subject to change without notice. Renesas grants you permission to use these resources only for development of an application that uses Renesas products. Other reproduction or use of these resources is strictly prohibited. No license is granted to any other Renesas intellectual property or to any third party intellectual property. Renesas disclaims responsibility for, and you will fully indemnify Renesas and its representatives against, any claims, damages, costs, losses, or liabilities arising out of your use of these resources. Renesas' products are provided only subject to Renesas' Terms and Conditions of Sale or other applicable terms agreed to in writing. No use of any Renesas resources expands or otherwise alters any applicable warranties or warranty disclaimers for these products.

(Disclaimer Rev.1.0 Mar 2020)

### Corporate Headquarters

TOYOSU FORESIA, 3-2-24 Toyosu,  
Koto-ku, Tokyo 135-0061, Japan  
[www.renesas.com](http://www.renesas.com)

### Contact Information

For further information on a product, technology, the most up-to-date version of a document, or your nearest sales office, please visit:  
[www.renesas.com/contact/](http://www.renesas.com/contact/)

### Trademarks

Renesas and the Renesas logo are trademarks of Renesas Electronics Corporation. All trademarks and registered trademarks are the property of their respective owners.