



TAOGLAS®



Datasheet

NCS.5820

Part No:
NCS.5820

Description:

Extensis NCS Series Embedded NB-IoT SMD Antenna covering Bands 5, 8 & 20

Features:

Low Profile, Small Footprint SMD Antenna

Global NB-IoT Coverage for:

- Band 5, 824-894MHz
- Band 8, 880-960MHz
- Band 20, 791-862MHz

High Efficiency across each Band

Dimensions: 20 x 11 x 1.6mm

RoHS & Reach Compliant

1. Introduction	3
2. Specifications	5
3. Antenna Characteristics	6
4. Radiation Patterns	8
5. Mechanical Drawing	13
6. Antenna Integration Guide	17
7. Evaluation Board Matching Circuit	20
8. Packaging	21
<hr/>	
Changelog	22

Taoglas makes no warranties based on the accuracy or completeness of the contents of this document and reserves the right to make changes to specifications and product descriptions at any time without notice. Taoglas reserves all rights to this document and the information contained herein.

Reproduction, use or disclosure to third parties without express permission is strictly prohibited.

Copyright © Taoglas Ltd.



1. Introduction

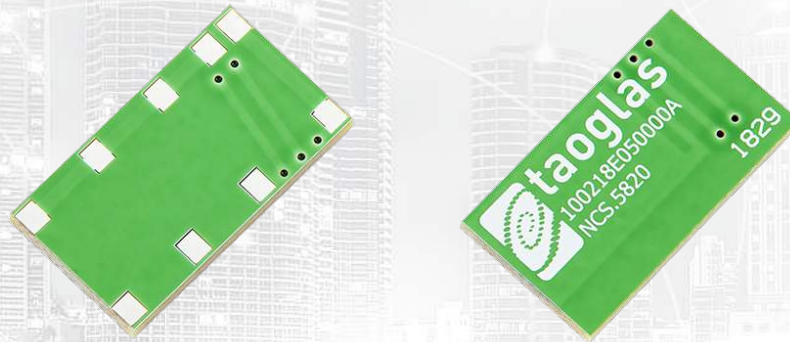

The evolution of IoT connectivity has seen an urgent need for a low power way to connect thousands of devices. The Extensis NCS series of NB-IoT embedded antennas are the smallest form factor antennas on the market to facilitate this demand.

This part no. the NCS.5820 supports Bands 5 (824-894MHz), 8 (880-960MHz) and 20 (791-862MHz) and demonstrates excellent efficiency in providing global NB-IoT coverage. This antenna will allow the device manufacturer to enjoy mobilization between all bands so that the device can be used in more than one region with more than one carrier. On the contrary, an antenna covering only one band will have less mobility and will not be suitable for international roaming over Low Power Wide Area networks.

With a super low profile height of 1.6 mm and a footprint of just 11 x 20mm, the surface mount antenna can be easily integrated into even the smallest of devices. It allows device designers to take advantage of all of the benefits of NB-IoT technology, including reduced power consumption and increased battery life; increased system capacity and spectrum efficiency; and extended coverage in both rural and deep indoors environments all with a very small form factor. For testing, it can be supplied on the NCS.D.5820 evaluation board, see section 5.2.

Typical applications include:

- :: Remote monitoring / Smart meters
- :: Smart cities & buildings
- :: Agriculture
- :: Network devices
- :: Manufacturing automation,
- :: Environment and asset tracking.

Ease of integration and exceptional performance of this antenna make it the perfect starting point for any NB-IoT device design. It is also an ideal choice for cost-sensitive applications considering also that the material used for this antenna is lower cost than the traditional ceramic NB-IoT antenna.

Overall, this antenna is suitable for applications that need to meet the following requirements:

- Small footprint, low profile design factors
- Long battery life of up to 10 years is required
- Deep indoor penetration with +20dB link budget compared with GSM is required
- Low cost, with an industry target of < \$5 per radio module. The material used for this antenna is lower cost than the traditional ceramic NB-IoT antenna
- High security from proven LTE-based security mechanisms
- A worldwide 3GPP industry standard on operator-managed networks in licensed spectrum
- Possibility of up to 100x more devices per cell compared with GSM

For more information or support with integrating this antenna into your device, please contact your regional Taoglas Customer Support Team.

2. Specifications

Electrical			
Frequency (MHz)	Band 5	Band 8	Band 20
	824~894	880~960	791~862
Peak Gain (dBi)*	0.1	0.1	-0.8
Average Gain (dB)*	-3.8	-3.6	-4.1
Efficiency (%)*	42	44	39
Return Loss (dB)*	<-6	<-7	<-7
Polarization	Linear		
Impedance	50 Ω		
Maximum Input Power	5W		
Mechanical			
Antenna Dimensions	20mm x 11mm x 1.6mm		
Material	FR4		
Weight	0.74 g		
Soldering Type	SMT through Reflow		
Environmental			
Operation Temperature	-40°C ~ +85°C		
Storage Temperature	-40°C ~ +85°C		
Moisture Sensitivity Level (MSL)	3 (168 Hours)		
Humidity	Non-condensing 65°C 95% RH		

*Note: All measurements were conducted with SMT on a 115*35mm evaluation board with 100mm length ground plane and matching circuit. See EVB drawing and matching circuit diagram in Section 5 and Section 7.

3. Antenna Characteristics

All data was measured on the evaluation board illustrated in Section 5, with the documented matching circuit.

3.1 NCS.5820

Return Loss

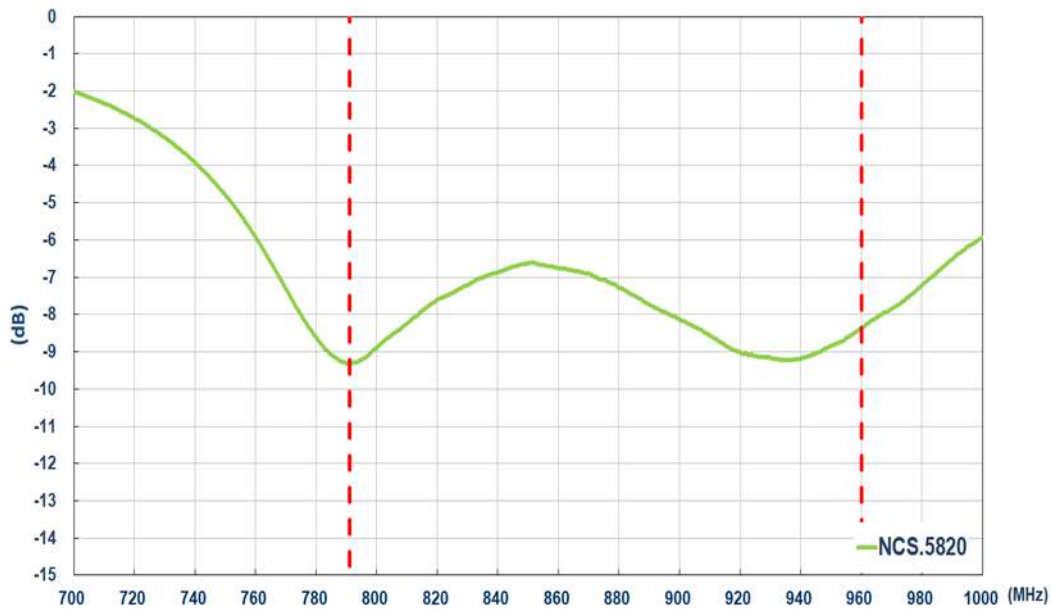

Efficiency

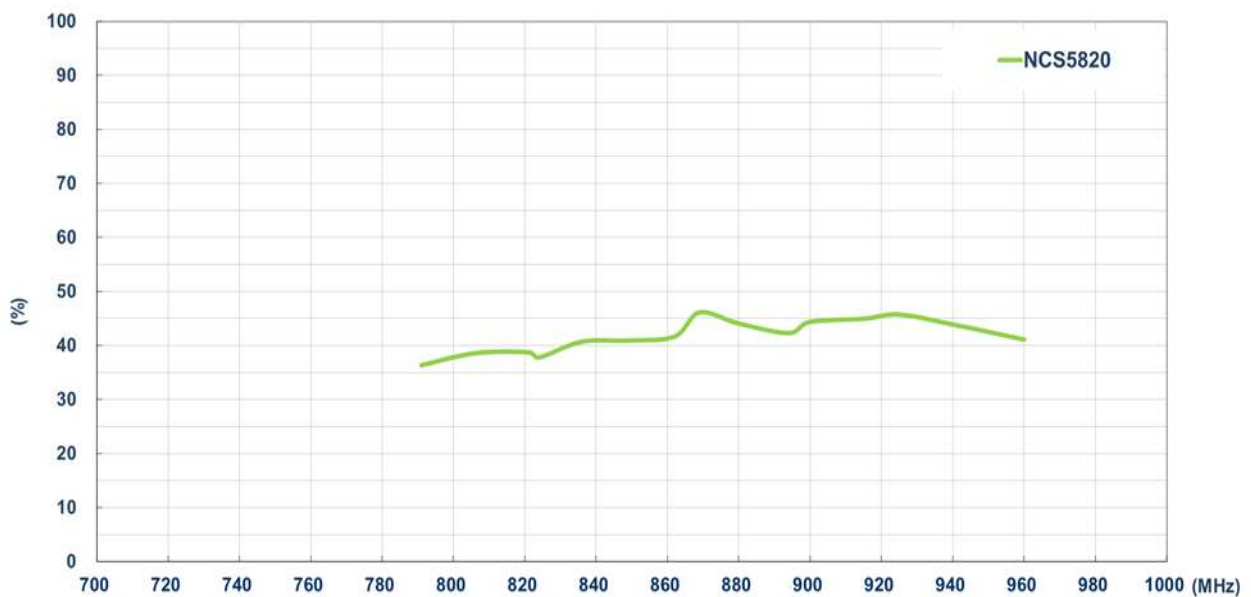

Average Gain

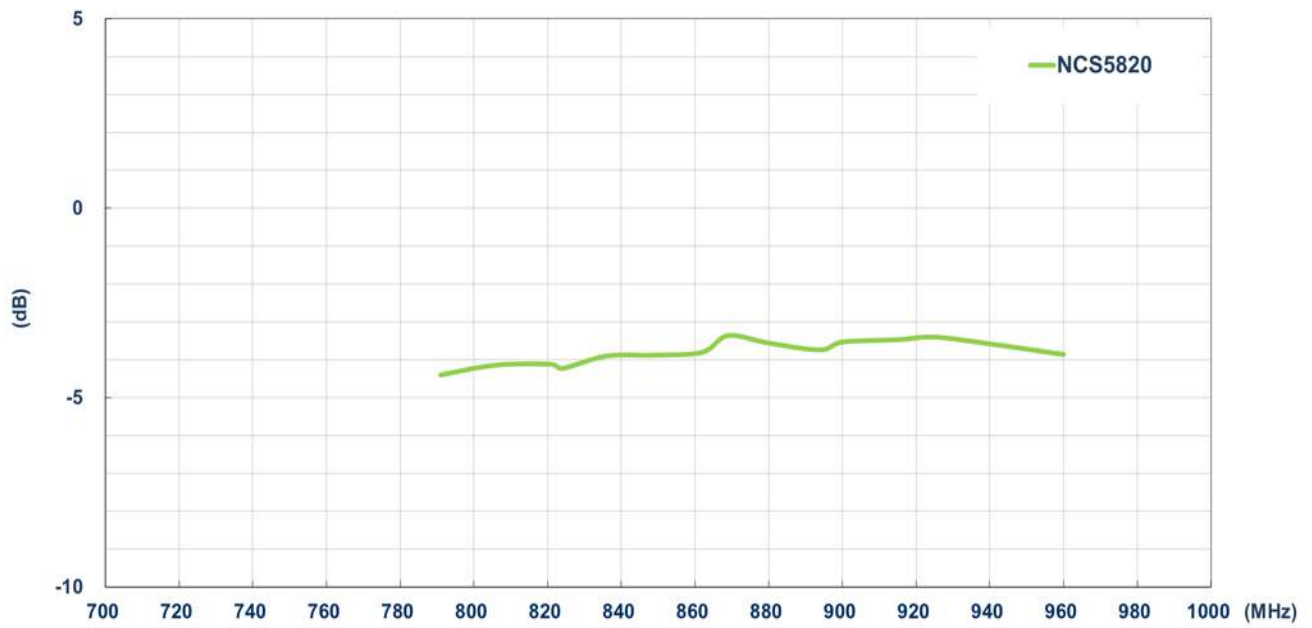

Peak Gain

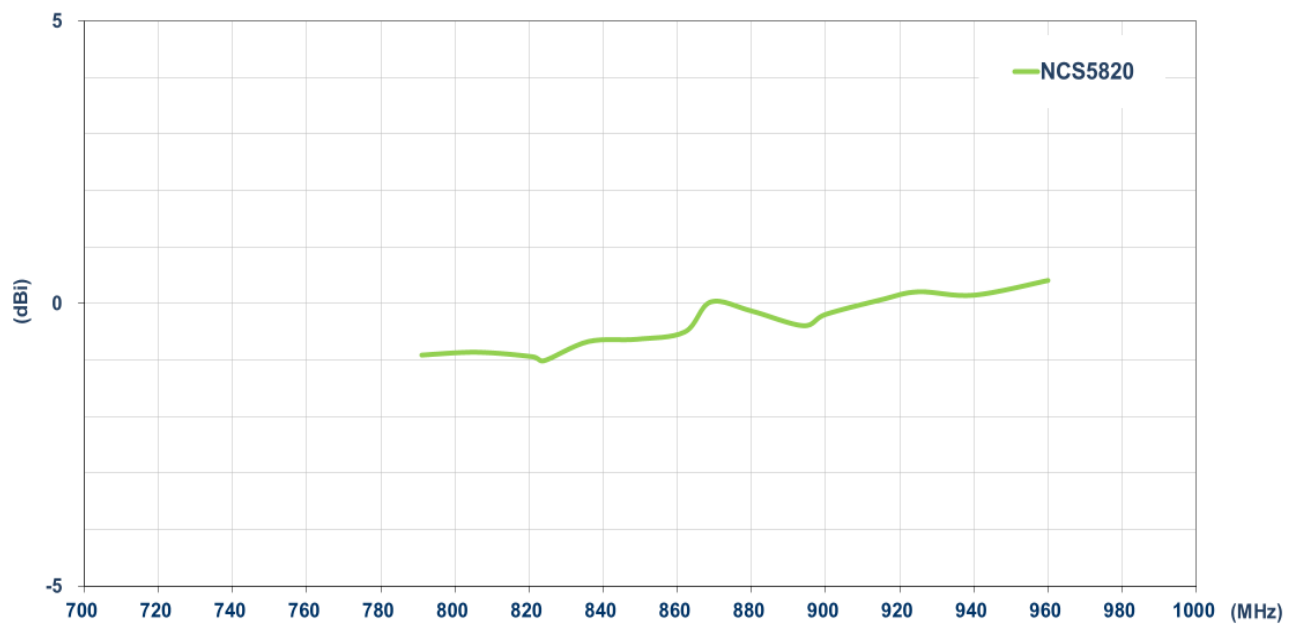

4. Radiation Patterns

4.1 Test Setup - on NCSD.5820 Evaluation Board

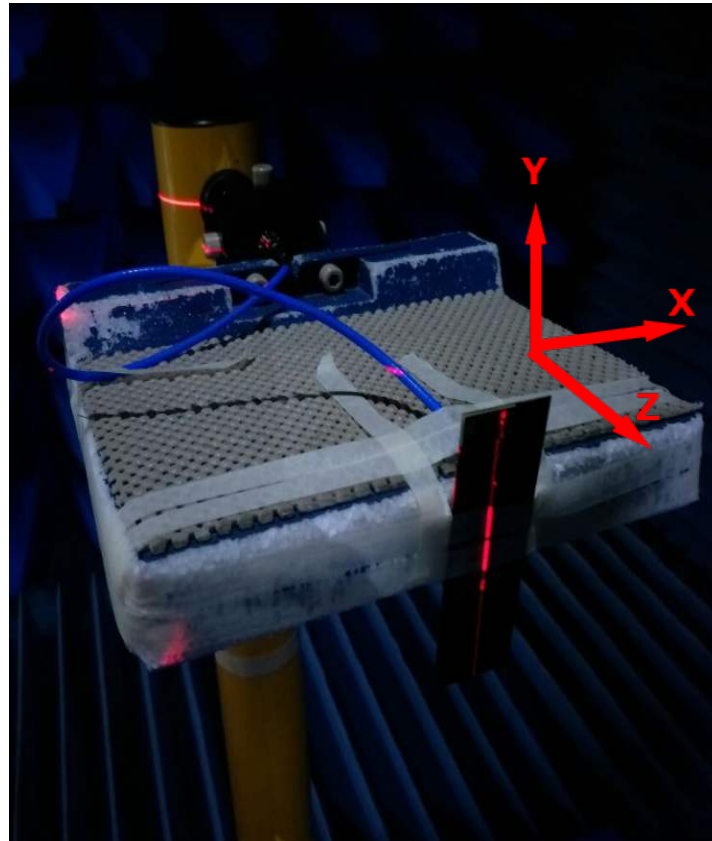

4.2 791MHz 3D and 2D Radiation Patterns

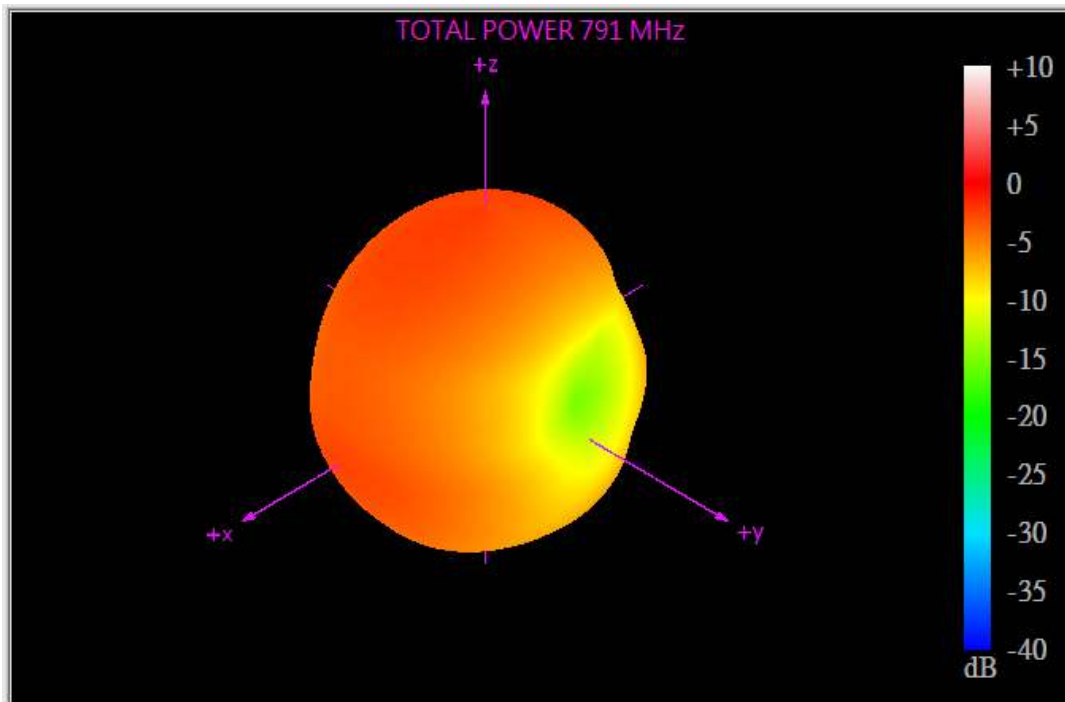

XZ Plane

YZ Plane

XY Plane

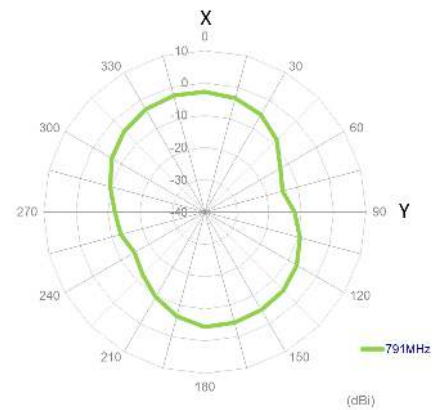
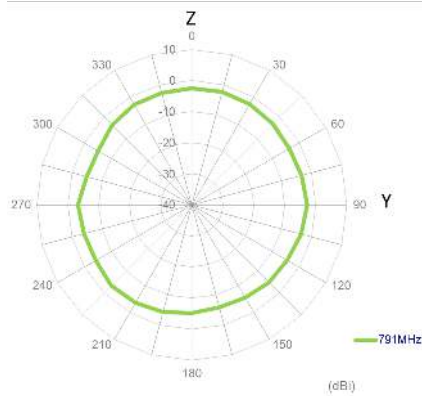
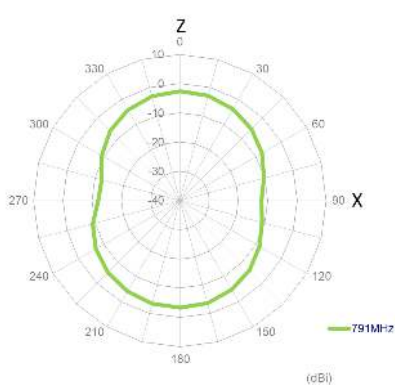

4.3 824 MHz 3D and 2D Radiation Patterns

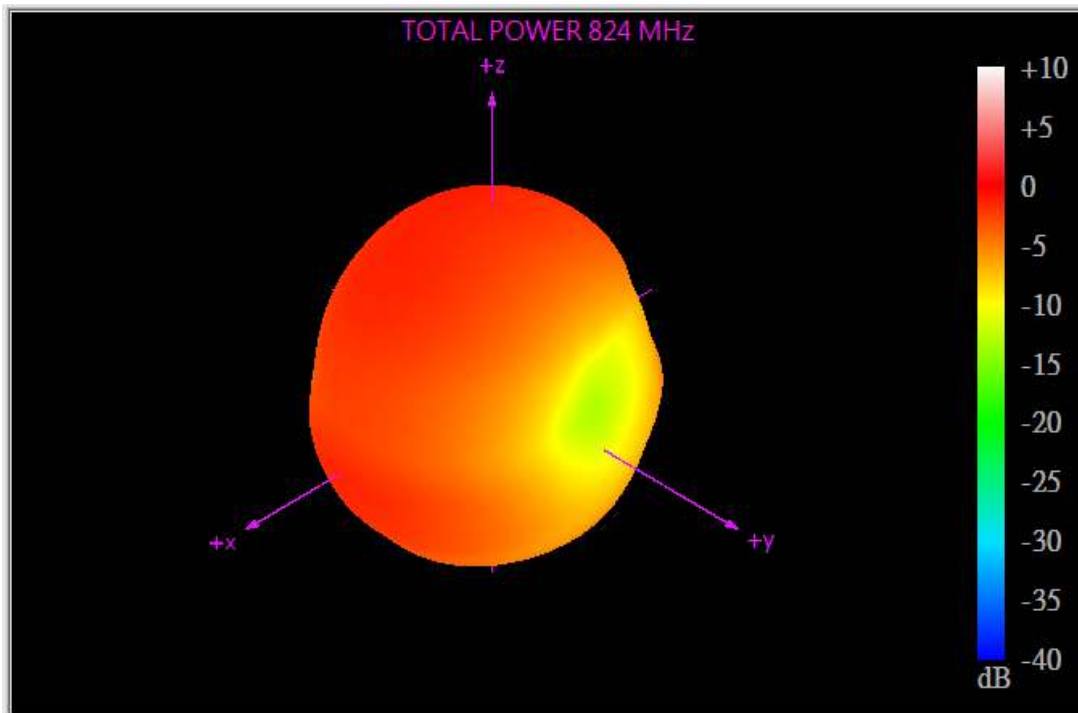

XZ Plane

YZ Plane

XY Plane

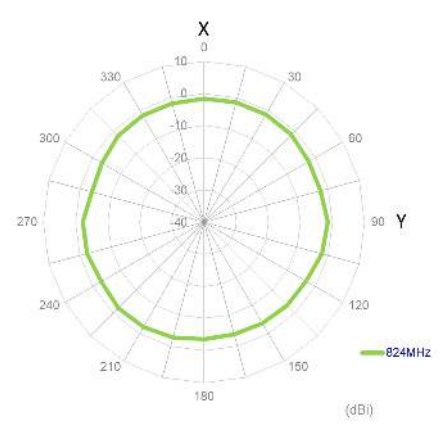
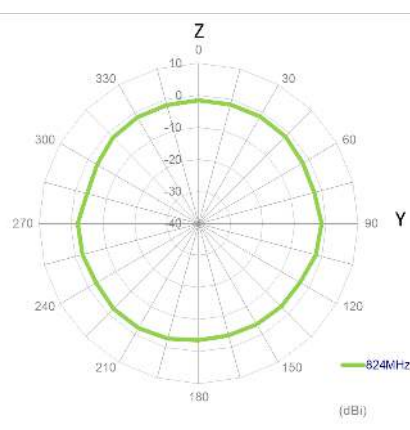
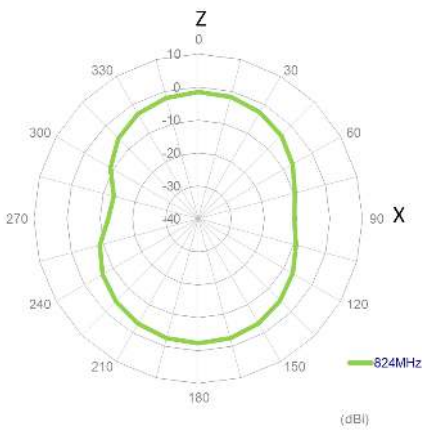

4.4 862 MHz 3D and 2D Radiation Patterns

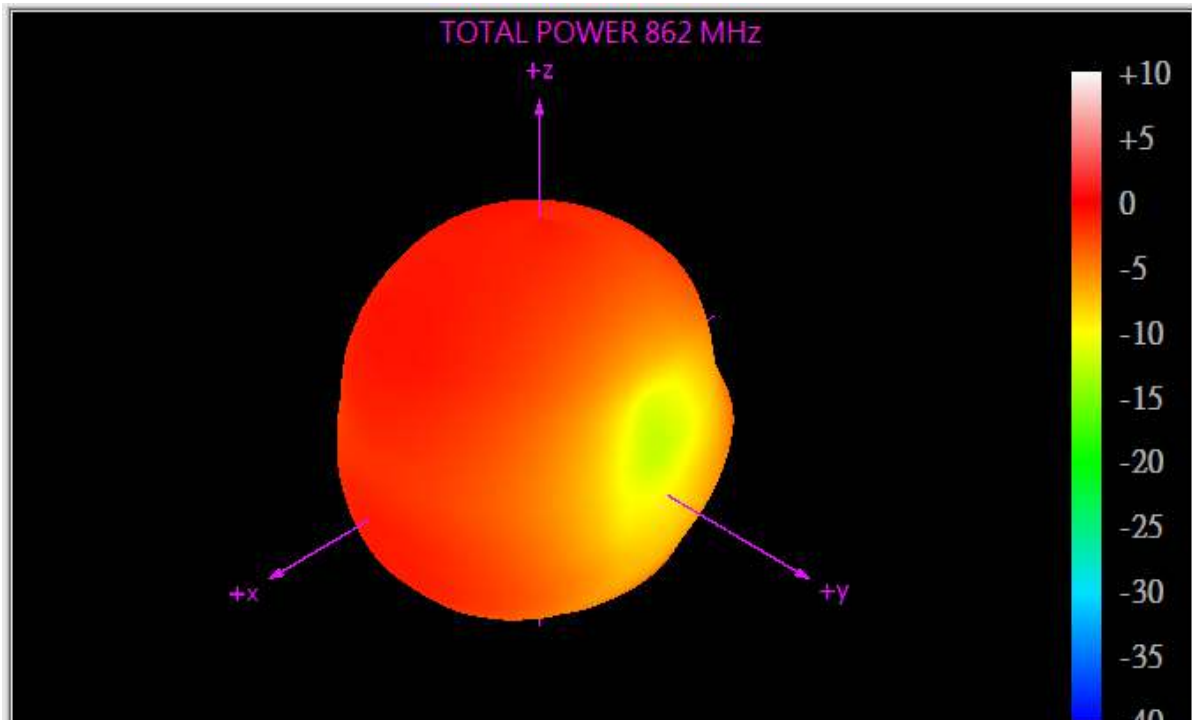

XZ Plane

YZ Plane

XY Plane

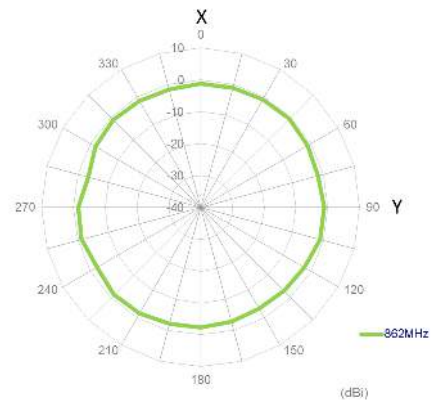
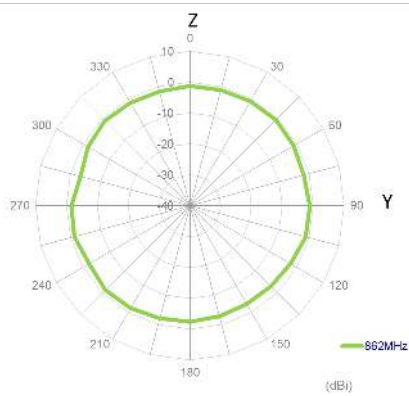
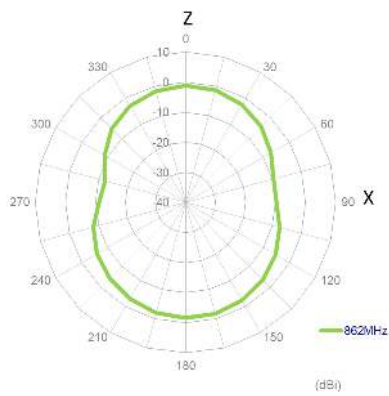

4.5 960 MHz 3D and 2D Radiation Patterns

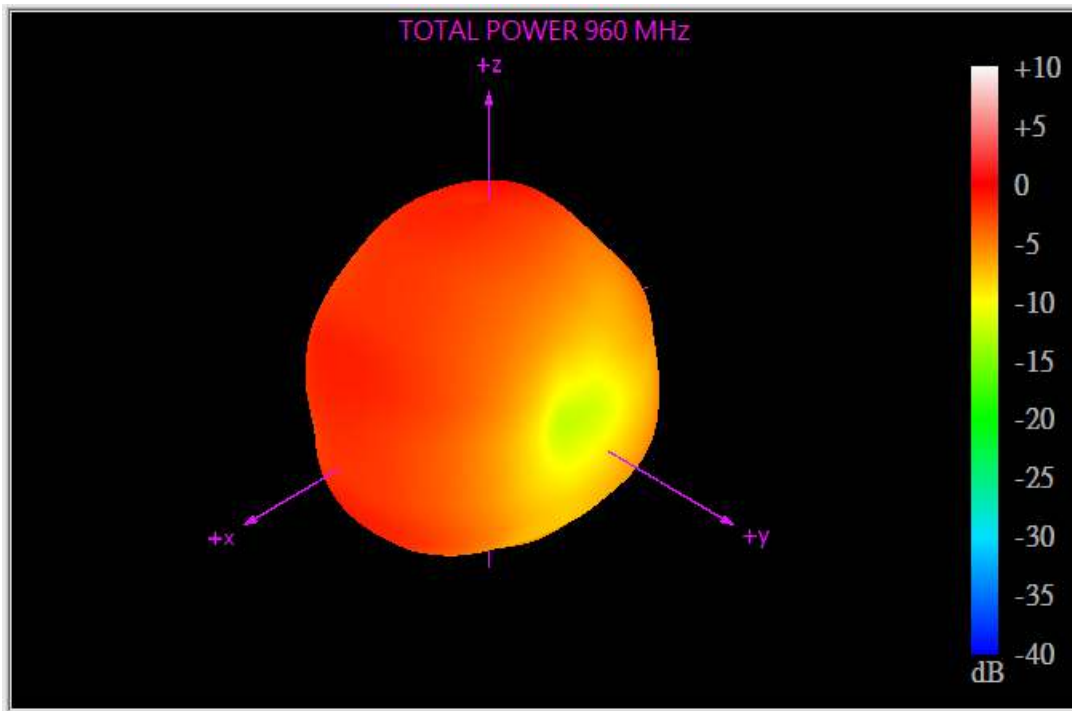

XZ Plane

YZ Plane

XY Plane

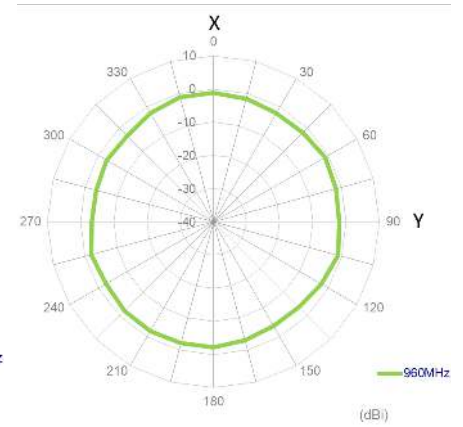
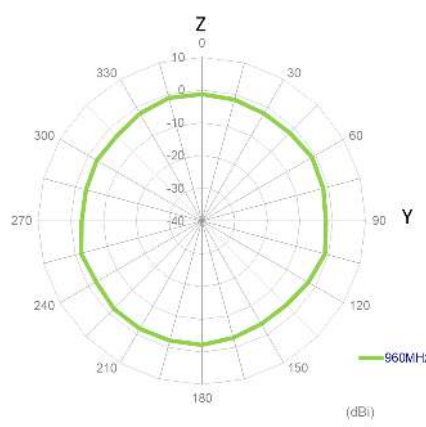
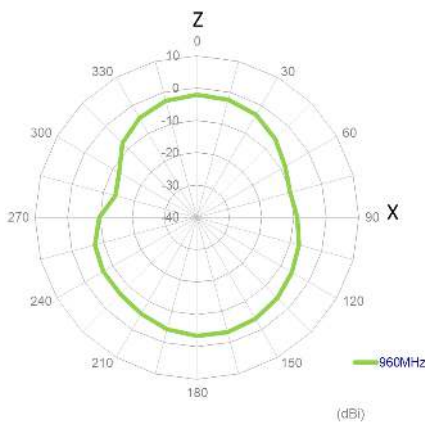

5. Mechanical Drawing (Units: mm)

5.1 Antenna Drawing

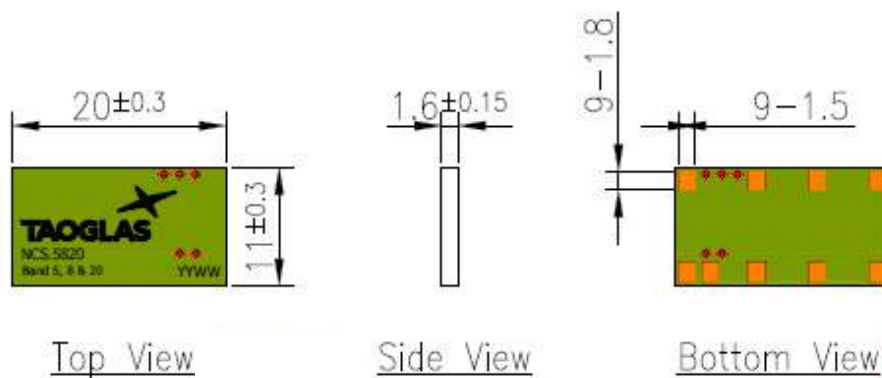

5.2 Antenna Footprint

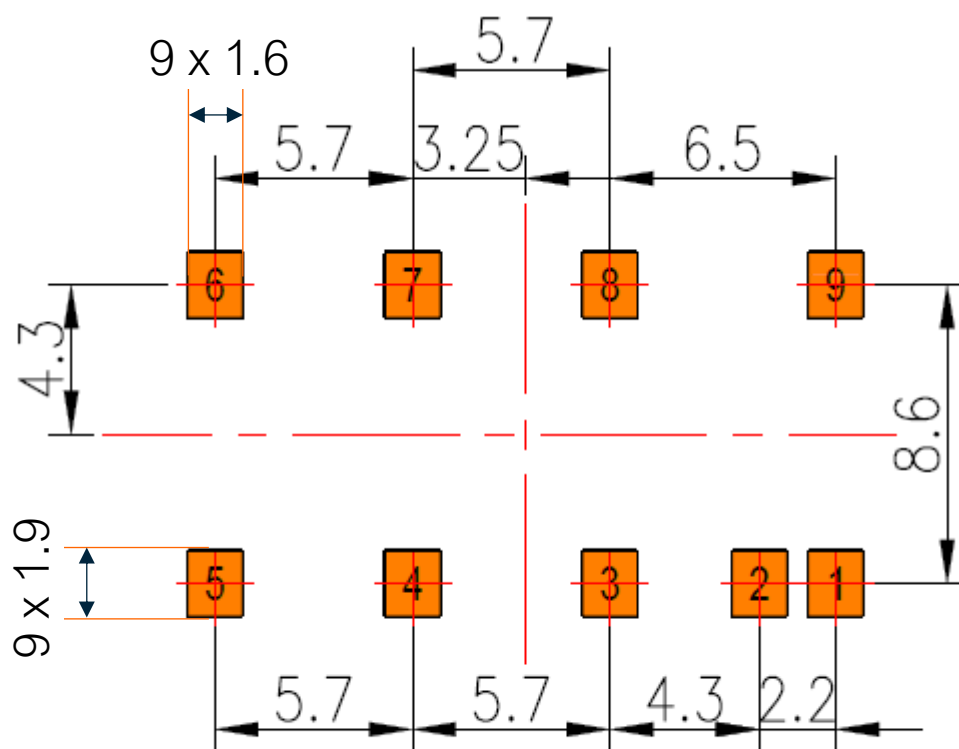



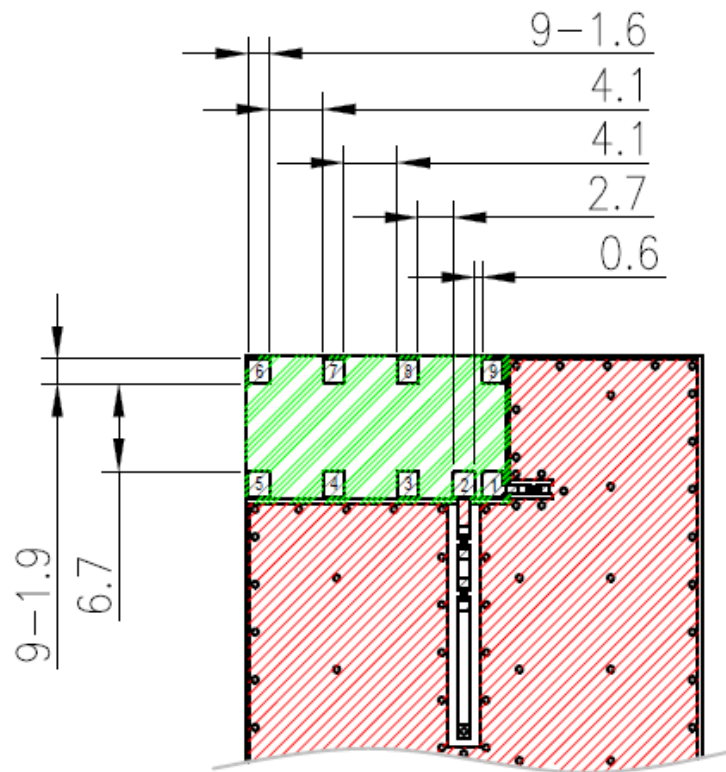

5.3 Pad Layout

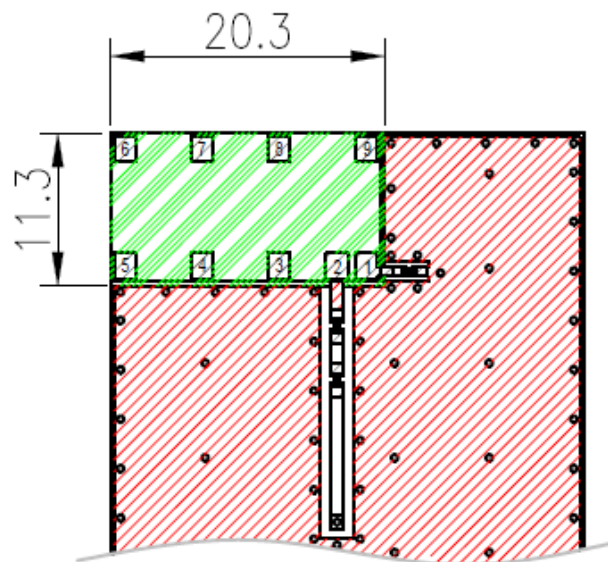

5.4 Copper Keep Out Area – Top View





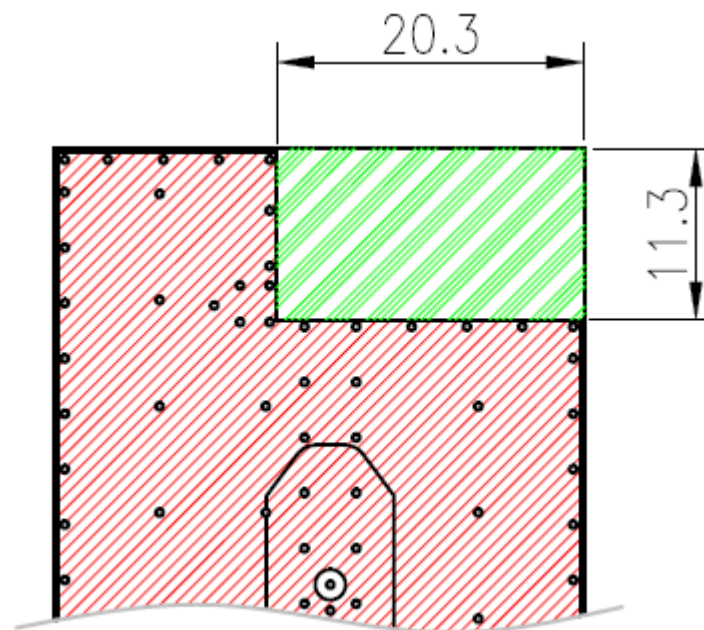

Note:

1. Week Batch Code
Example: 2013 Week 10=1310
2. Soldered area 
3. Copper area 
4. Logo & Text Ink Printing : White
5. Ground Clearance Area 
6. HASL 
7. Soldermask (Green_LF03HF) 
8. Matching – Value Changes According To Ground And Layout.

5.5 Copper Keep-Out Area – Bottom View



Note:

1. Week Batch Code
Example: 2013 Week 10=1310
2. Soldered area 
3. Copper area 
4. Logo & Text Ink Printing : White
5. Ground Clearance Area 
6. HASL 
7. Soldermask (Green_LF03HF) 
8. Matching – Value Changes According To Ground And Layout.

5.6 Evaluation Board

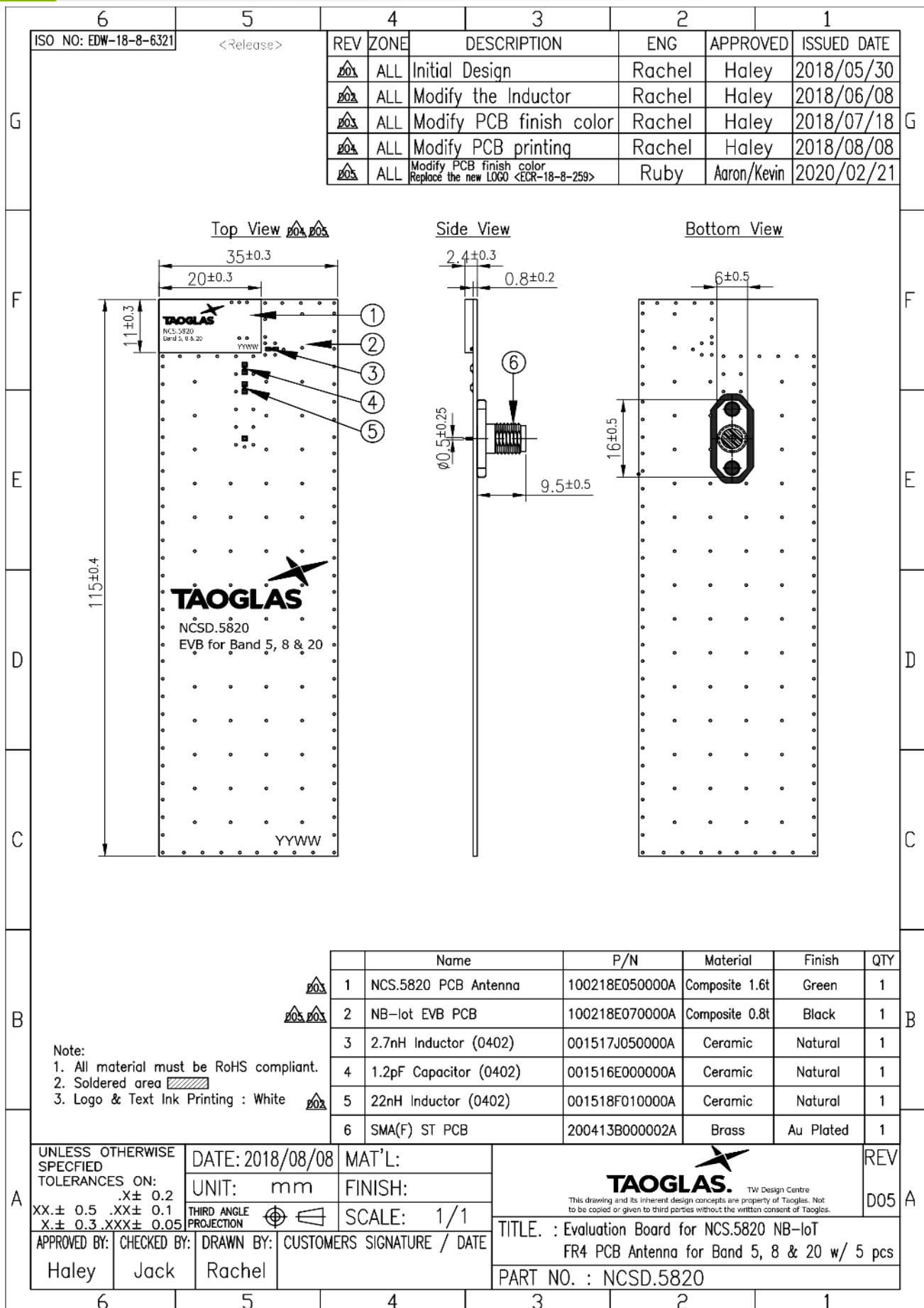

6. Antenna Integration Guide

6.1 Integration Guide

The ideal location for the antenna is as illustrated in the below diagram; on the PCB's shortest side, in the left corner. This allows placement of the optimized matching components alongside the antenna.

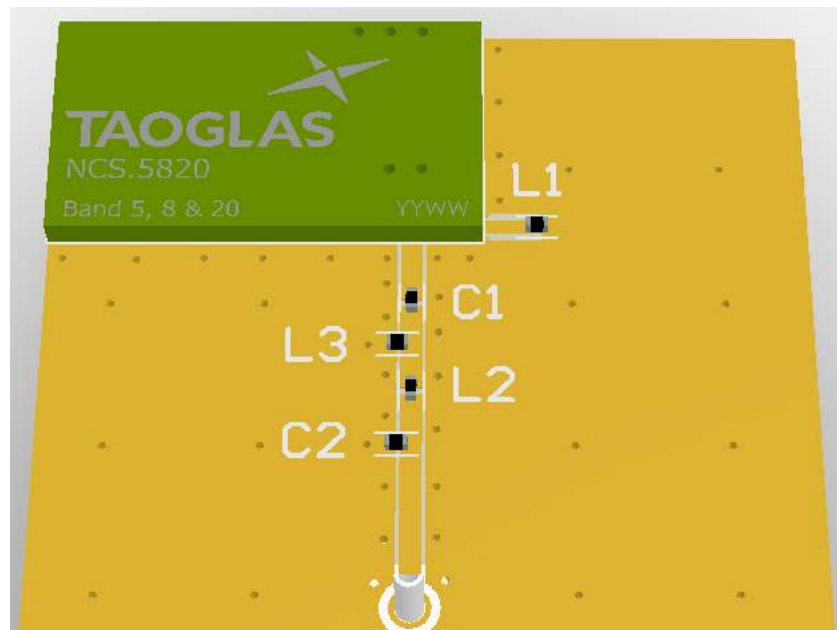

6.2 PCB Layout

The footprint and clearance on the PCB must comply with the antenna specification. The PCB layout shown in the diagram below demonstrates the antenna footprint and the clearance required.

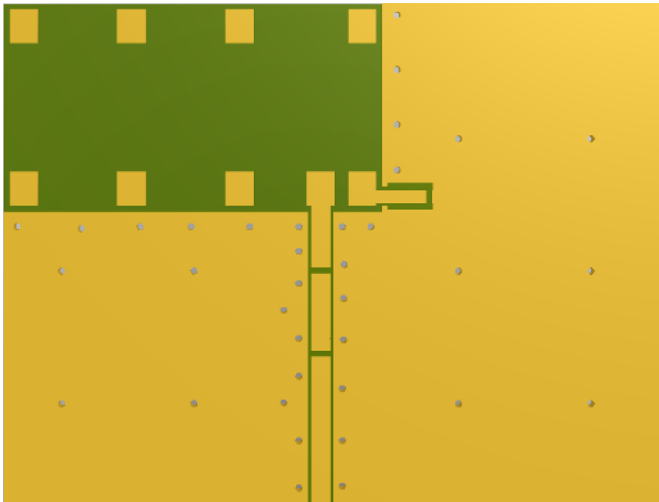

Top View

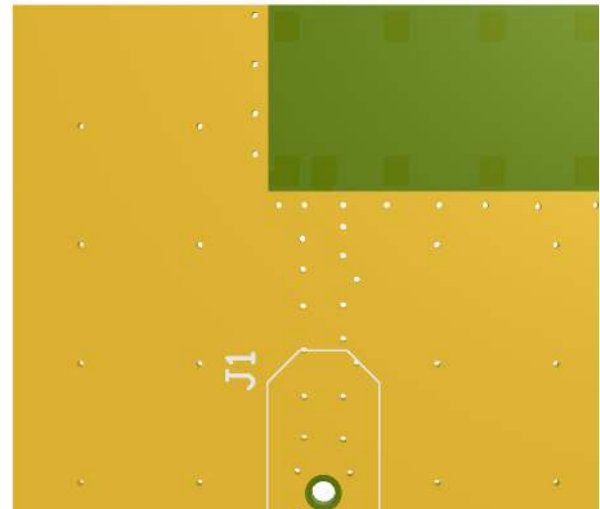

Bottom View

6.3 PCB Clearance

In the figure in this section, the footprint and clearance are defined through all layers on the PCB. Only the antenna pads and connections to feed and GND are present within this clearance area (marked RED). The clearance area required is 20.3 x 11.3 (mm).

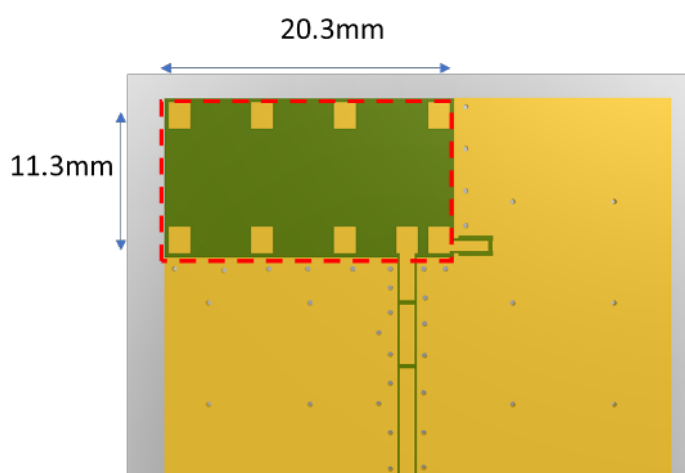

Top View

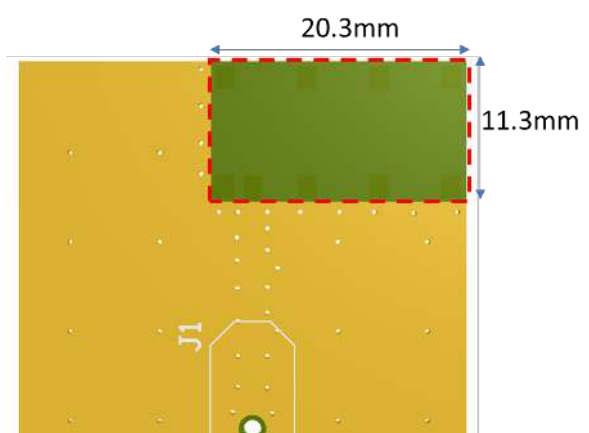

Bottom View

6.4 Schematic Symbol and Pin Definitions

The circuit symbol for the antenna is shown below. The antenna has 9 pins with only two as functional.

Pin	Description
1	Ground
2	RF Feed
3, 4, 5, 6, 7, 8, 9	Not Connected

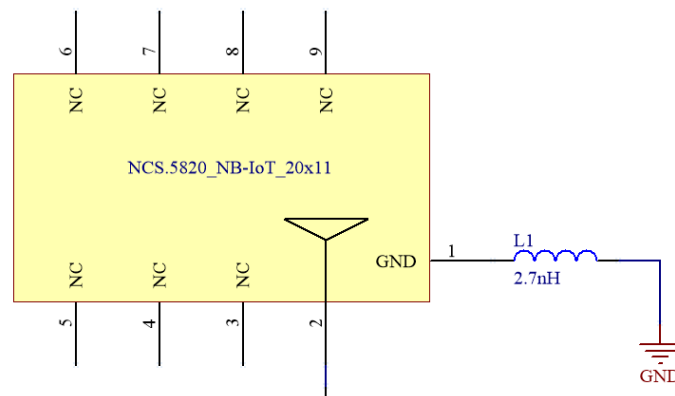

7. Evaluation Board Matching Circuit

This antenna requires a matching circuit which can be optimized for each product integration. This matching circuit will require up to four components and the circuit illustrated in the below diagram should be designed onto the carrier PCB. All components may not be required but should be included as a provision. To ensure optimum tuning the matching network must be placed in close proximity to the antenna feed.

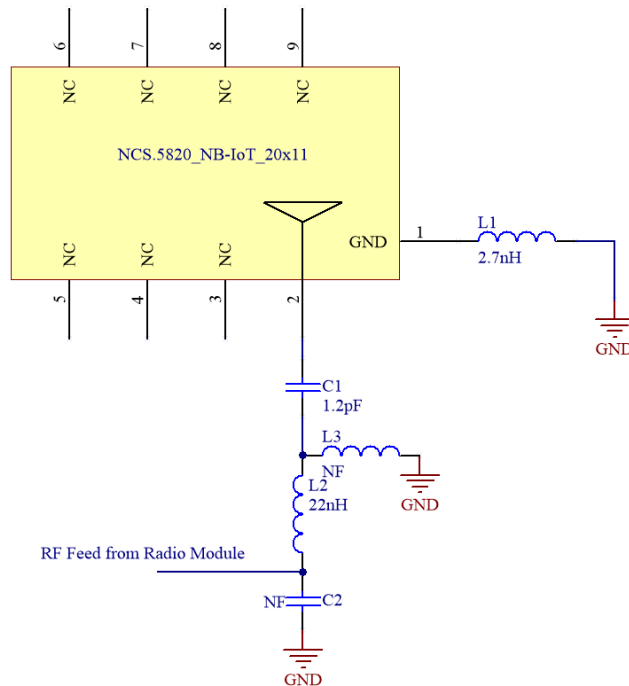

Matching Components

Designator	Type	Value	Description
C1	Capacitor	1.2pF	Murata GJM1555 series
C2	Not Fitted		
L1	Inductor	2.7nH	Murata LQG15HS series
L2	Inductor	22nH	Murata LQG15HS series
L3	Not Fitted		

8. Packaging

1000pcs NCS.5820 per Tape & Reel
 Dimensions - 350*340*47mm
 Weight: 1Kg

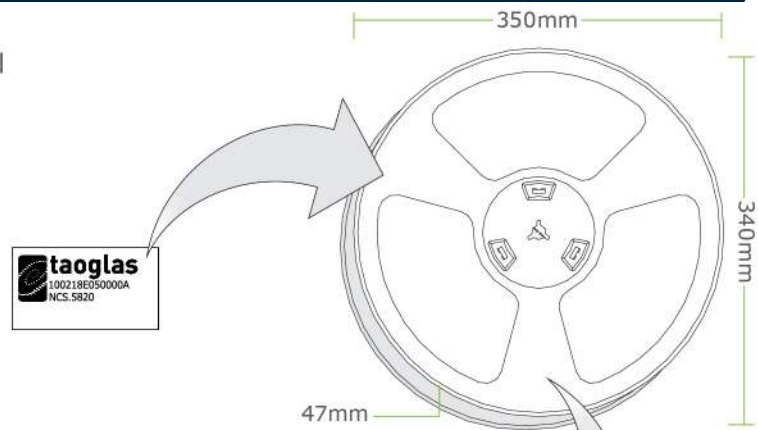

6000pcs NCS.5820 per carton
 Dimensions: 370*370*300mm
 Weight: 6Kg

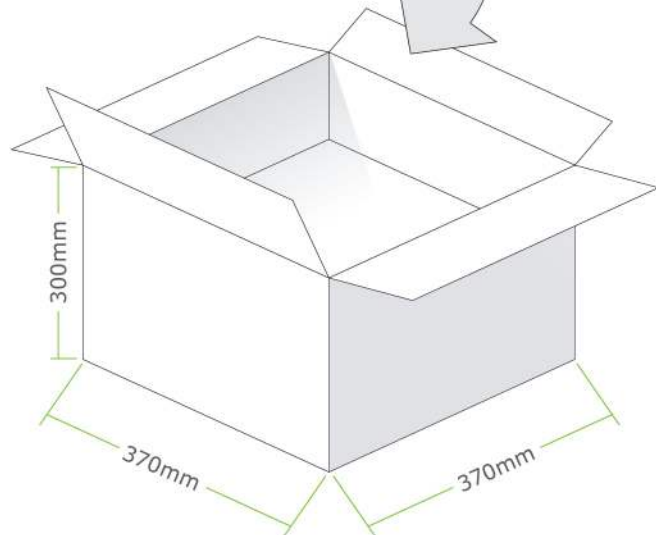

Changelog for the datasheet

SPE-18-8-099 – NCS.5820

Revision: F (Current Version)	
Date:	2020-08-17
Changes:	Updated MSL information.
Changes Made by:	Erik Landi

Previous Revisions

Revision: E	
Date:	2020-08-17
Changes:	Updated Pin Information
Changes Made by:	Jack Conroy

Revision: D	
Date:	2020-02-27
Changes:	Updated Footprint Data
Changes Made by:	Jack Conroy

Revision: C	
Date:	2019-09-19
Changes:	Updated Template
Changes Made by:	Yu Kai Yeung

Revision: B	
Date:	2018-09-17
Changes:	Updated Drawing
Changes Made by:	Jack Conroy

Revision: A	
Date:	2018-12-11
Changes:	Initial Release
Changes Made by:	Jack Conroy



TAOGLAS®

www.taoglas.com

