

### Features

- Drives IGBT/MOSFET power devices
- Floating channel designed for bootstrap operation
- Fully operational to +600 V
- Tolerant to negative transient voltage – dV/dt immune
- Gate drive supply range from 10 V to 20 V
- Undervoltage lockout for both channels
- 3.3 V input logic compatible
- Separate logic supply range from 3.3 V to 20 V
- Logic and power ground +/- 5 V offset
- CMOS Schmitt-triggered inputs with pull-down shutdown logic
- Matched propagation delay for both channels
- Output in phase with inputs
- Leadfree, RoHS compliant
- Automotive qualified\*

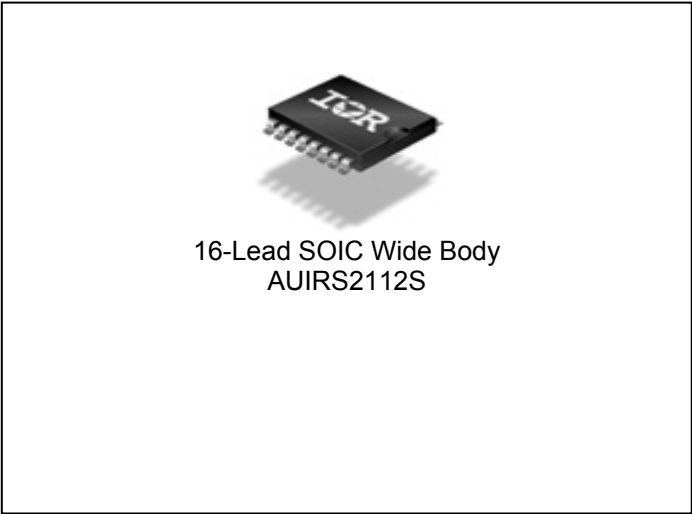
### Typical Applications

- Piezo, Common Rail Injection
- MOSFET and IGBT gate drivers

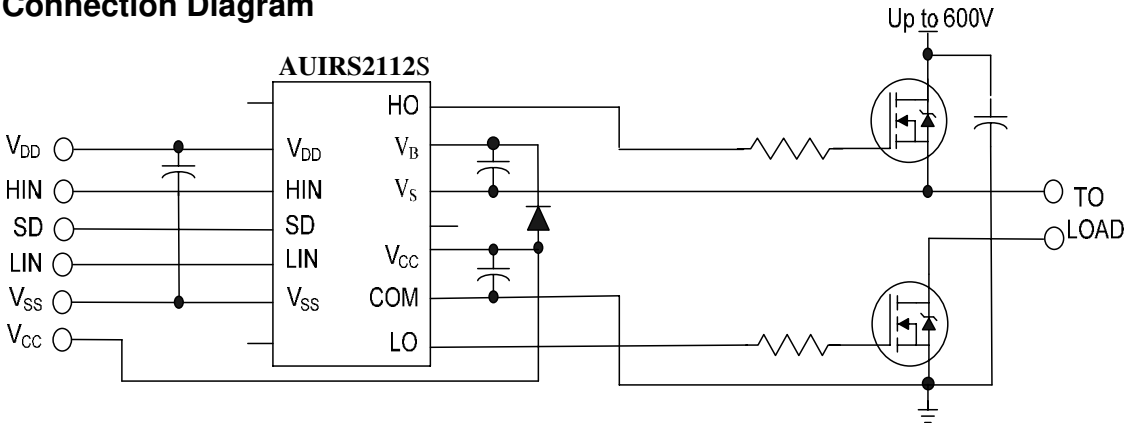
### Product Summary

Topology	High and Low Side Driver
V <sub>OFFSET</sub>	≤ 600 V
V <sub>OUT</sub>	10 V – 20 V
I <sub>o+</sub> & I <sub>o-</sub> (typical)	290 mA & 600 mA
t <sub>ON</sub> & t <sub>OFF</sub> (typical)	140 ns & 140 ns

### Package Options



### Typical Connection Diagram



(Refer to Lead Assignments for correct pin configuration). This/These diagram(s) show electrical connections only. Please refer to our Application Notes and Design Tips for proper circuit board layout.

\* Qualification standards can be found on IR's web site [www.irf.com](http://www.irf.com)

<b>Table of Contents</b>	<b>Page</b>
Description	3
Qualification Information	4
Absolute Maximum Ratings	5
Recommended Operating Conditions	5
Static Electrical Characteristics	6
Dynamic Electrical Characteristics	6
Functional Block Diagram	7
Input/Output Pin Equivalent Circuit Diagram	8
Lead Definitions	9
Lead Assignments	9
Application Information and Additional Details	10-11
Tolerability to Negative VS Transients	12
Parameter Temperature Voltage Trends	13-20
Package Details	20
Tape and Reel Details	21
Part Marking Information	22
Ordering Information	22
Important Notice	23

## **Description**

The AUIRS2112S is a high voltage, high speed power MOSFET and IGBT driver with independent high- and low-side referenced output channels. Proprietary HVIC and latch immune CMOS technologies enable ruggedized monolithic construction. The logic input is compatible with standard CMOS or LSTTL output, down to 3.3 V logic. The output drivers feature a high pulse current buffer stage designed for minimum driver cross-conduction. Propagation delays are matched to simplify use in high frequency applications. The floating channel can be used to drive an N-channel power MOSFET or IGBT in the high side configuration which operates up to 600 V.

**Qualification Information<sup>†</sup>**

<b>Qualification Level</b>		Automotive (per AEC-Q100 <sup>††</sup> )	
		Comments: This family of ICs has passed an Automotive qualification. IR's Industrial and Consumer qualification level is granted by extension of the higher Automotive level.	
<b>Moisture Sensitivity Level</b>		SOIC16W	MSL3 <sup>†††</sup> 260°C (per IPC/JEDEC J-STD-020)
<b>ESD</b>	Machine Model	Class M2 (Pass +/-150 V) (per AEC-Q100-003)	
	Human Body Model	Class H1B (Pass +/-1000V) (per AEC-Q100-002)	
	Charged Device Model	Class C4 (Pass +/-1000V) (per AEC-Q100-011)	
<b>IC Latch-Up Test</b>		Class II, Level B <sup>††††</sup> (per AEC-Q100-004)	
<b>RoHS Compliant</b>		Yes	

† Qualification standards can be found at International Rectifier's web site <http://www.irf.com/>

†† Exceptions to AEC-Q100 requirements are noted in the qualification report.

††† Higher MSL ratings may be available for the specific package types listed here. Please contact your International Rectifier sales representative for further information.

†††† Input pins can withstand up to 40 mA.

### Absolute Maximum Ratings

Absolute Maximum Ratings indicate sustained limits beyond which damage to the device may occur. All voltage parameters are absolute voltages referenced to COM lead. Stresses beyond those listed under "Absolute Maximum Ratings" may cause permanent damage to the device. These are stress ratings only; and functional operation of the device at these or any other condition beyond those indicated in the "Recommended Operating Conditions" is not implied. Exposure to absolute-maximum-rated conditions for extended periods may affect device reliability. The thermal resistance and power dissipation ratings are measured under board mounted and still air conditions. Ambient temperature ( $T_A$ ) is 25°C, unless otherwise specified.

Symbol	Definition	Min.	Max.	Units
$V_B$	High-side floating supply voltage	-0.3	625	V
$V_S$	High-side floating supply offset voltage	$V_B - 25$	$V_B + 0.3$	
$V_{HO}$	High-side floating output voltage	$V_S - 0.3$	$V_B + 0.3$	
$V_{CC}$	Low-side fixed supply voltage	-0.3	25	
$V_{LO}$	Low-side output voltage	-0.3	$V_{CC} + 0.3$	
$V_{DD}$	Logic supply voltage	-0.3	$V_{SS} + 25$	
$V_{SS}$	Logic supply offset voltage	$V_{CC} - 25$	$V_{CC} + 0.3$	
$V_{IN}$	Logic input voltage (HIN, LIN & SD)	$V_{SS} - 0.3$	$V_{DD} + 0.3$	
$dV_S/dt$	Allowable offset supply voltage transient (Fig. 2)	—	50	V/ns
$P_D$	Package power dissipation @ $T_A \leq 25^\circ\text{C}$	—	1.25	W
$R_{thJA}$	Thermal resistance, junction to ambient	—	100	$^\circ\text{C}/\text{W}$
$T_J$	Junction temperature	—	150	$^\circ\text{C}$
$T_S$	Storage temperature	-55	150	
$T_L$	Lead temperature (soldering, 10 seconds)	—	300	
$R_{thJC}$	Thermal resistance, junction to case	---	12.72	

### Recommended Operation Conditions

The input/output logic timing diagram is shown in Figure 1. For proper operation the device should be used within the recommended conditions. The  $V_S$  and  $V_{SS}$  offset rating are tested with all supplies biased at 15 V differential.

Symbol	Definition	Min.	Max.	Units
$V_B$	High-side floating supply absolute voltage	$V_S + 10$	$V_S + 20$	V
$V_S$	High-side floating supply offset voltage	†	600	
$V_{HO}$	High-side floating output voltage	$V_S$	$V_B$	
$V_{CC}$	Low-side fixed supply voltage	10	20	
$V_{LO}$	Low-side output voltage	0	$V_{CC}$	
$V_{DD}$	Logic supply voltage	$V_{SS} + 3$	$V_{SS} + 20$	
$V_{SS}$	Logic ground offset voltage	-5 (††)	5	
$V_{IN}$	Logic input voltage (HIN, LIN & SD)	$V_{SS}$	$V_{DD}$	
$T_A$	Ambient temperature	-40	125	$^\circ\text{C}$

† Logic operational for  $V_S$  of -5 V to +600 V. Logic state held for  $V_S$  of -5 V to  $-V_{BS}$  (Static).

Please refer to 'Tolerability to Negative VS Transients' section.

†† When  $V_{DD} < 5$  V, the minimum  $V_{SS}$  offset is limited to  $-V_{DD}$ .

### Dynamic Electrical Characteristics

Unless otherwise noted, these specifications apply for an operating junction temperature range of  $-40^{\circ}\text{C} \leq T_j \leq 125^{\circ}\text{C}$  with bias conditions of  $V_{\text{BIAS}} (V_{\text{CC}}, V_{\text{BS}}, V_{\text{DD}}) = 15\text{ V}$ ,  $C_L = 1000\text{ pF}$ . The dynamic electrical characteristics are measured using the test circuit shown in Fig. 3.

Symbol	Definition	Min	Typ	Max	Units	Test Conditions
$t_{\text{on}}$	Turn-on propagation delay	—	140	230	ns	$V_S = 0\text{ V}$
$t_{\text{off}}$	Turn-off propagation delay	—	140	210		$V_S = 600\text{ V}$
$t_{\text{sd}}$	Shutdown propagation delay	—	140	220		
$t_r$	Turn-on rise time	—	60	140		
$t_f$	Turn-off fall time	—	30	60		
MT	Delay matching , HS & LS turn-on/off	—	—	50		

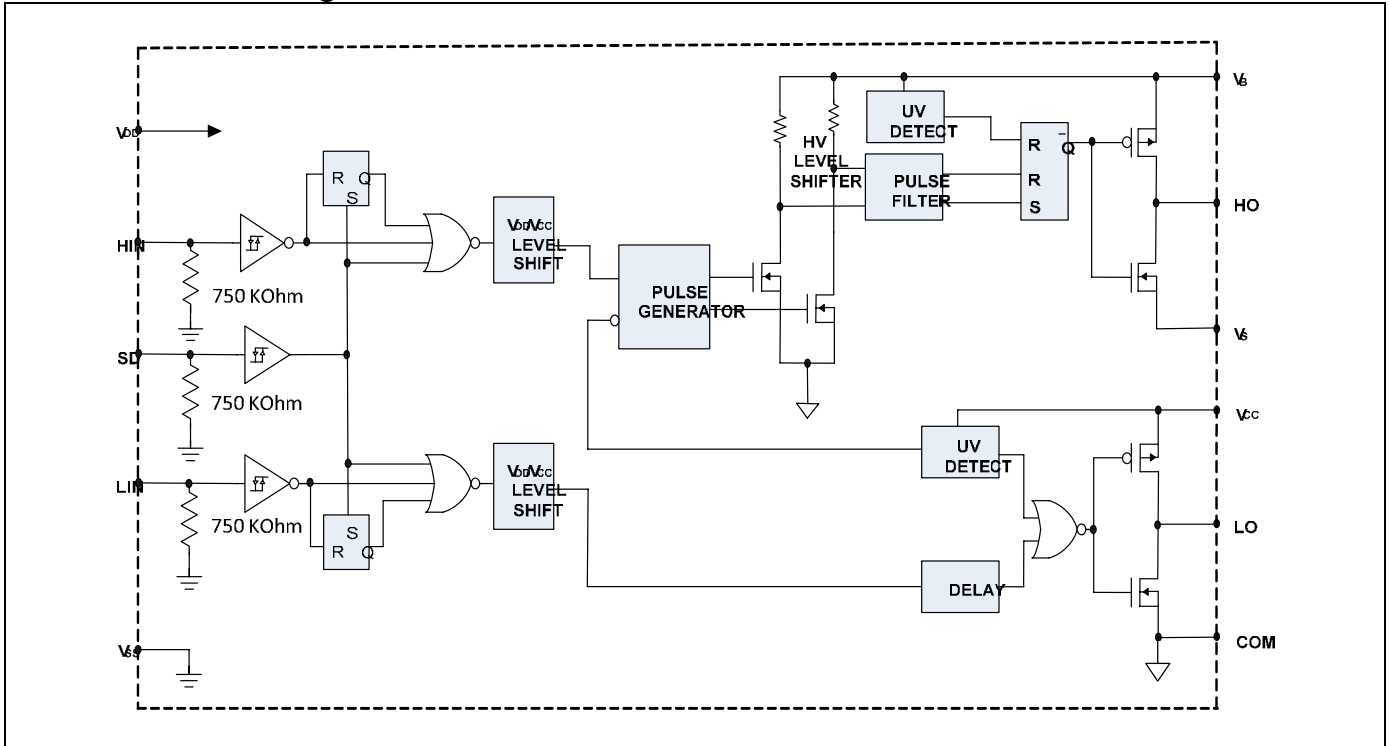
### Static Electrical Characteristics

Unless otherwise noted, these specifications apply for an operating junction temperature range of  $-40^{\circ}\text{C} \leq T_j \leq 125^{\circ}\text{C}$  with bias conditions of  $V_{\text{BIAS}} (V_{\text{CC}}, V_{\text{BS}}, V_{\text{DD}}) = 15\text{ V}$ ,  $C_L = 1000\text{ pF}$ ,  $V_{\text{SS}} = \text{COM}$ . The  $V_{\text{IL}}$ ,  $V_{\text{IH}}$  and  $I_{\text{IN}}$  parameters are referenced to  $V_{\text{SS}}$  and are applicable to all three logic input leads: HIN, LIN and SD. The  $V_{\text{O}}$  and  $I_{\text{O}}$  parameters are referenced to COM and are applicable to the respective output leads: HO or LO.

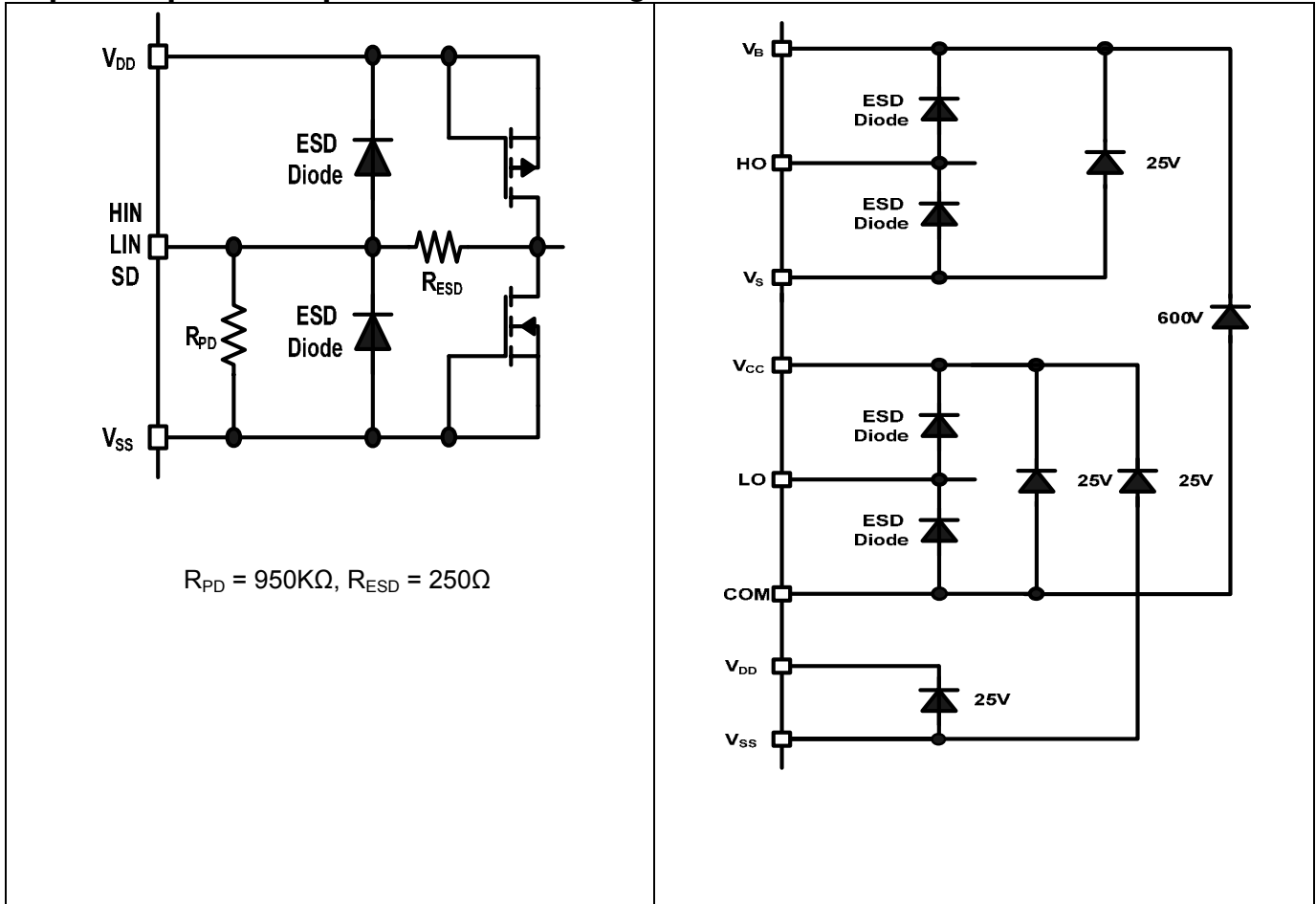
Symbol	Definition	Min	Typ	Max	Units	Test Conditions
$V_{\text{IH}}$	Logic "1" input voltage	9.5	—	—	V	$I_{\text{O}} = 2\text{ mA}$
$V_{\text{IL}}$	Logic "0" input voltage	—	—	6.0		
$V_{\text{OH}}$	High level output voltage, $V_{\text{BIAS}} - V_{\text{O}}$	—	0.05	0.2		
$V_{\text{OL}}$	Low level output voltage, $V_{\text{O}}$	—	0.02	0.1		
$I_{\text{LK}}$	Offset supply leakage current	—	—	50	$\mu\text{A}$	$V_{\text{B}} = V_{\text{S}} = 600\text{ V}$
$I_{\text{QBS}}$	Quiescent $V_{\text{BS}}$ supply current	—	50	100		$V_{\text{IN}} = 0\text{ V}$ or $V_{\text{DD}}$
$I_{\text{QCC}}$	Quiescent $V_{\text{CC}}$ supply current	—	80	160		
$I_{\text{QDD}}$	Quiescent $V_{\text{DD}}$ supply current	—	2.0	10		
$I_{\text{IN+}}$	Logic "1" input bias current	—	15	30		$V_{\text{IN}} = V_{\text{DD}}$
$I_{\text{IN-}}$	Logic "0" input bias current	—	—	1.0	$V_{\text{IN}} = 0\text{ V}$	
$V_{\text{BSUV+}}$	$V_{\text{BS}}$ supply undervoltage positive going threshold	7.4	8.5	9.6	V	
$V_{\text{BSUV-}}$	$V_{\text{BS}}$ supply undervoltage negative going threshold	7.0	8.1	9.2		
$V_{\text{CCUV+}}$	$V_{\text{CC}}$ supply undervoltage positive going threshold	7.6	8.6	9.6		
$V_{\text{CCUV-}}$	$V_{\text{CC}}$ supply undervoltage negative going threshold	7.2	8.2	9.2		
$I_{\text{O+}}^{(\dagger)}$	Output high short circuit pulsed current	200	290	—	mA	$V_{\text{O}} = 0\text{ V}$ , $V_{\text{IN}} = V_{\text{DD}}$ $\text{PW} \leq 10\text{ }\mu\text{s}$ , $T_J = 25^{\circ}\text{C}$
$I_{\text{O-}}^{(\dagger)}$	Output low short circuit pulsed current	420	600	—		$V_{\text{O}} = 15\text{ V}$ , $V_{\text{IN}} = 0\text{ V}$ $\text{PW} \leq 10\text{ }\mu\text{s}$ , $T_J = 25^{\circ}\text{C}$

(†) Guaranteed by design

**Functional Block Diagram: AUIRS2112S**



**Input/Output Pin Equivalent Circuit Diagrams**

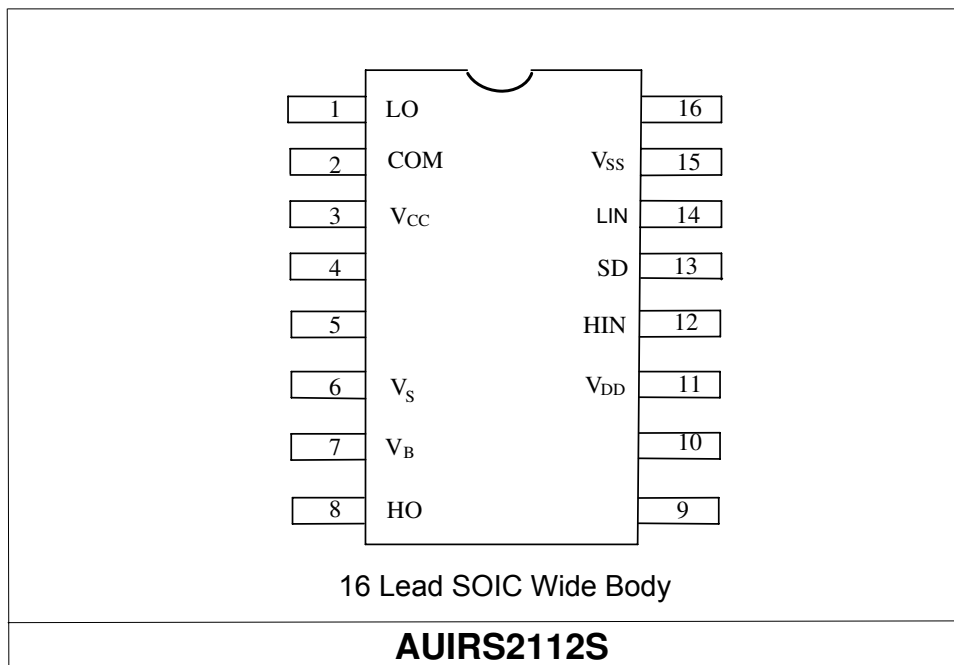




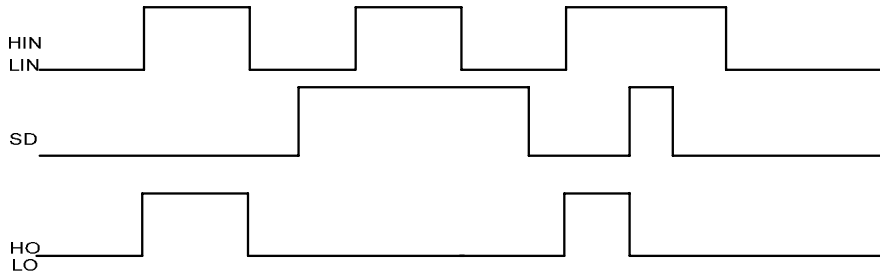
**Lead Definitions**

Symbol	Description
V <sub>DD</sub>	Logic supply
HIN	Logic input for high-side gate driver output (HO), in phase
SD	Logic input for shutdown
LIN	Logic input for low-side gate driver output (LO), in phase
V <sub>SS</sub>	Logic ground
V <sub>B</sub>	High-side floating supply
HO	High-side gate drive output
V <sub>S</sub>	High-side floating supply return
V <sub>CC</sub>	Low-side supply
LO	Low-side gate drive output
COM	Low-side return

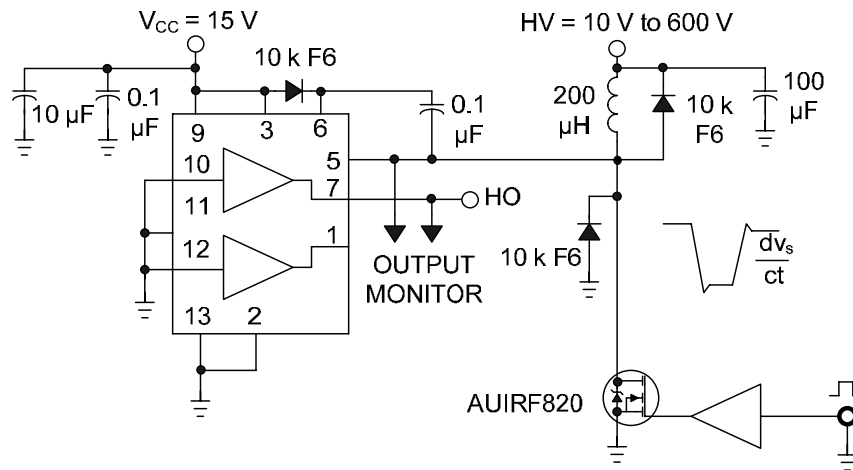
**Lead Assignments**



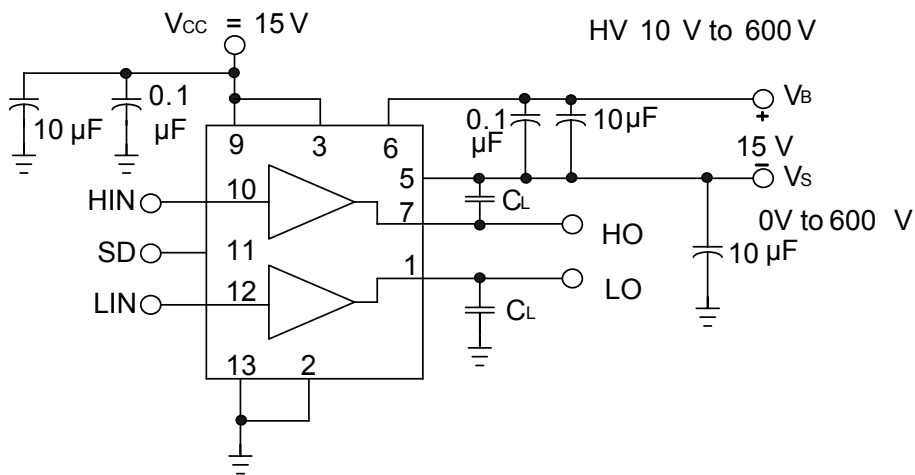
**Application Information and Additional Details**



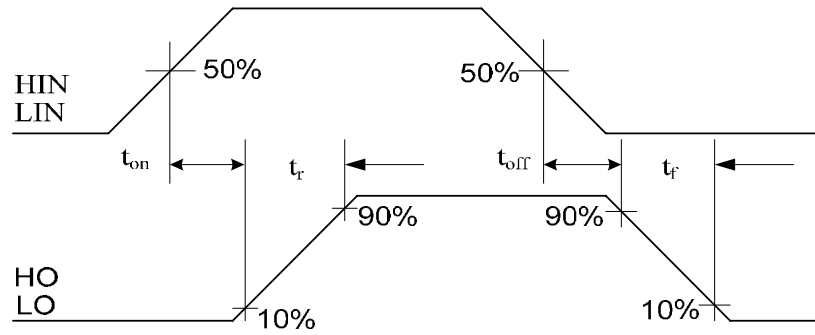
**Figure 1: Input/Output Timing Diagram**



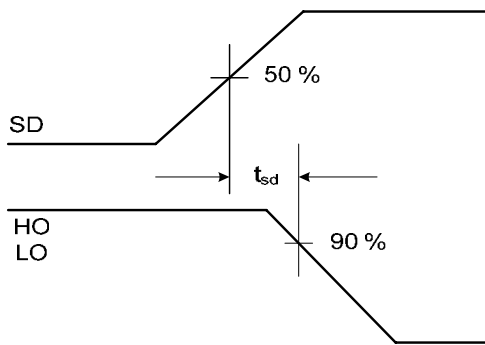
**Figure 2: Floating Supply Voltage Transient Test Circuit**



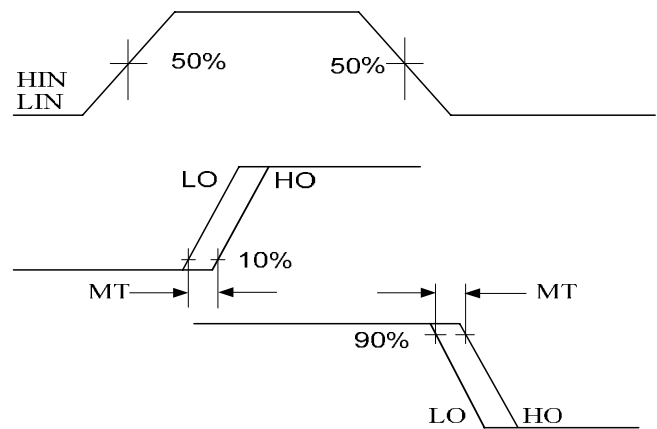
**Figure 3: Switching Time Test Circuit**



**Figure 4: Switching Time Waveform Definitions**



**Figure 5: Shutdown Waveform**



**Figure 6: Delay Matching Waveform Definitions**

**Tolerability to Negative  $V_s$  Transients**

The AUIRS2112S has been seen to withstand negative  $V_s$  transient conditions on the order of -25V for a period of 150 ns ( $V_{BIAS}$  ( $V_{CC}$ ,  $V_{BS}$ ) = 15V and  $T_A = 25^\circ\text{C}$ ).

An illustration of the AUIRS2112S performance can be seen in Figure 7, where points above the line represent pulses that the circuit can withstand.

Even though the AUIRS2112S has been shown able to handle these negative  $V_s$  transient conditions, it is highly recommended that the circuit designer always limit the negative  $V_s$  transients as much as possible by careful PCB layout and component use.

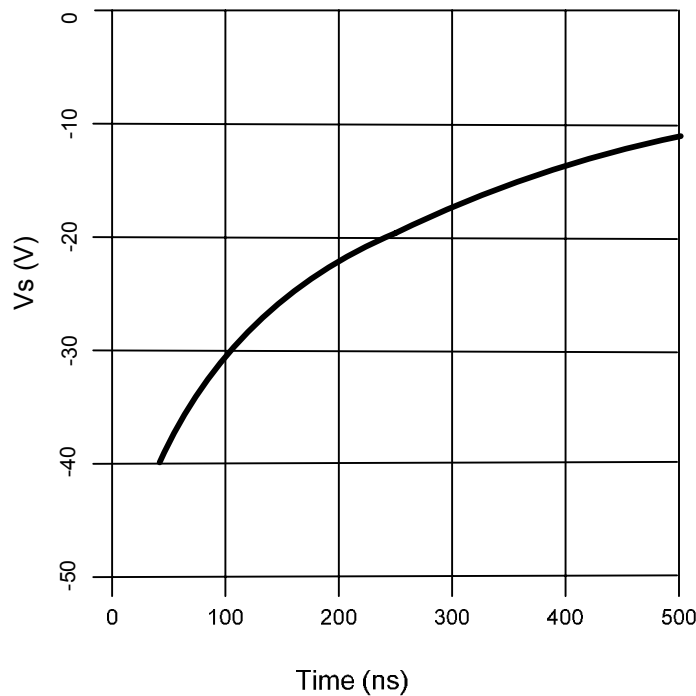
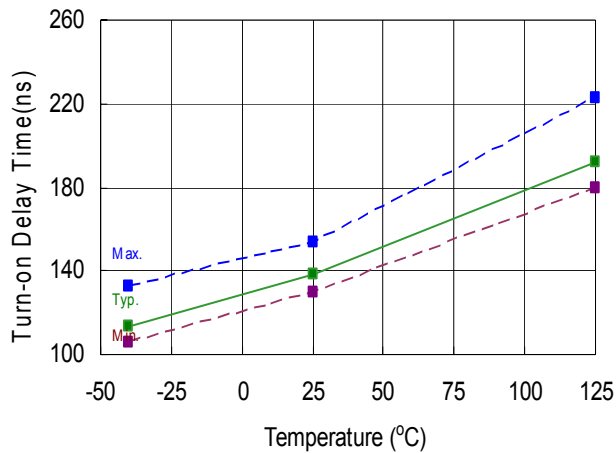


Figure 7: - $V_s$  Transient results

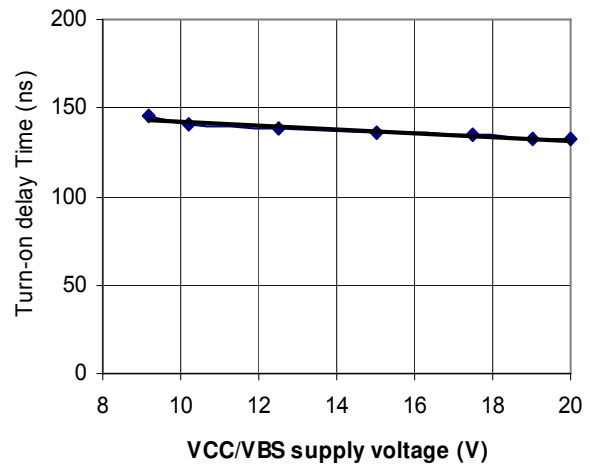
**Parameter Trends vs. Temperature and vs. Supply Voltage**

Figures illustrated in this chapter provide information on the experimental performance of the AUIRS2112S HVIC. The line plotted in each figure is generated from actual lab data. A large number of individual samples were tested at three temperatures (-40 °C, 25 °C, and 125 °C) with supply voltage of 15V in order to generate the experimental curve. The line consists of three data points (one data point at each of the tested temperatures) that have been connected together to illustrate the understood trend. The individual data points on the Typ. curve were determined by calculating the averaged experimental value of the parameter (for a given temperature).

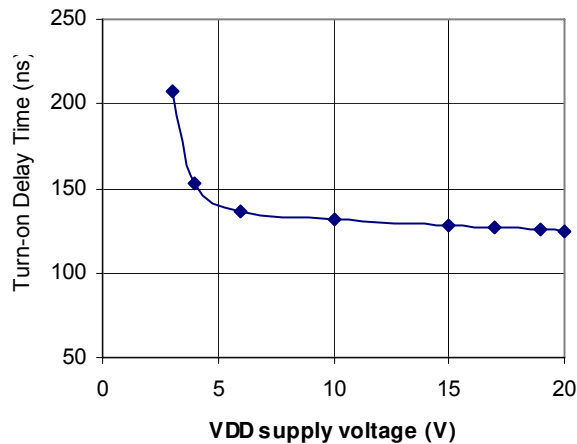
An individual sample was used to generate curves of parameter trends vs. supply voltage; tests were done at room temperature.



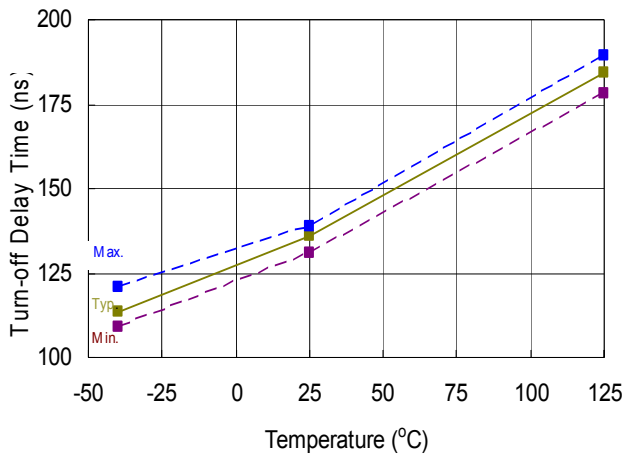
**Figure 8A.** Turn-on Propagation Delay Time vs. Temperature



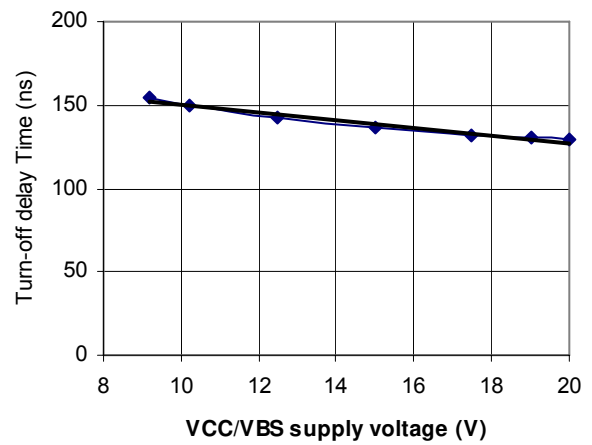
**Figure 8B.** Turn-on Propagation Delay Time vs.  $V_{CC}/V_{BS}$  Supply Voltage



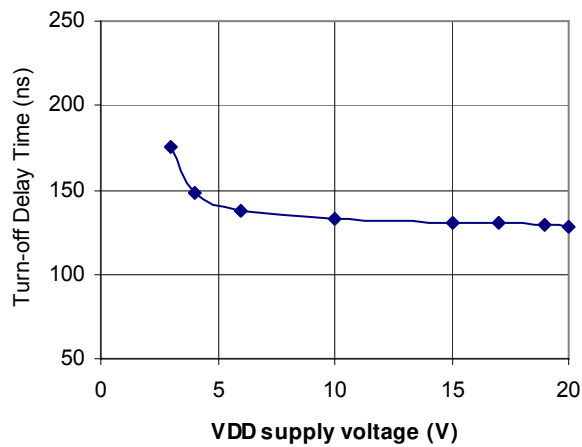
**Figure 8C.** Turn-on Propagation Delay Time vs.  $V_{DD}$  Supply Voltage



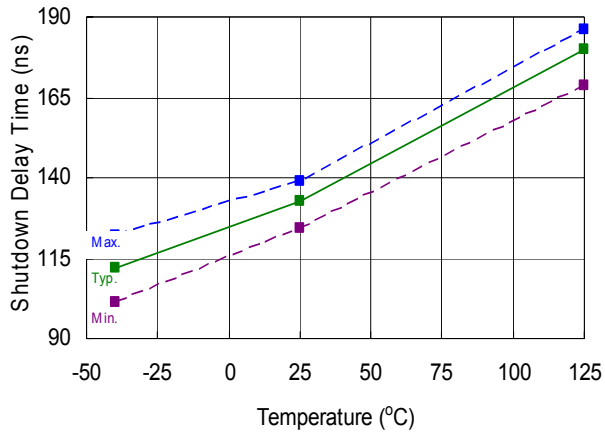
**Figure 9A.** Turn-off Propagation Delay Time vs. Temperature



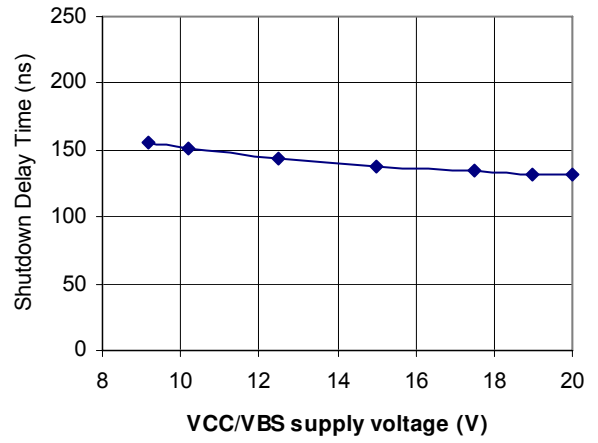
**Figure 9B.** Turn-off Propagation Delay Time vs. V<sub>CC</sub>/V<sub>BS</sub> Supply Voltage



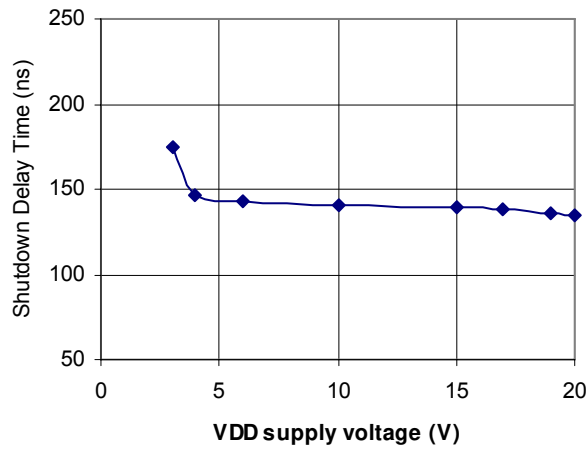
**Figure 9C.** Turn-off Propagation Delay Time vs. V<sub>DD</sub> Supply Voltage



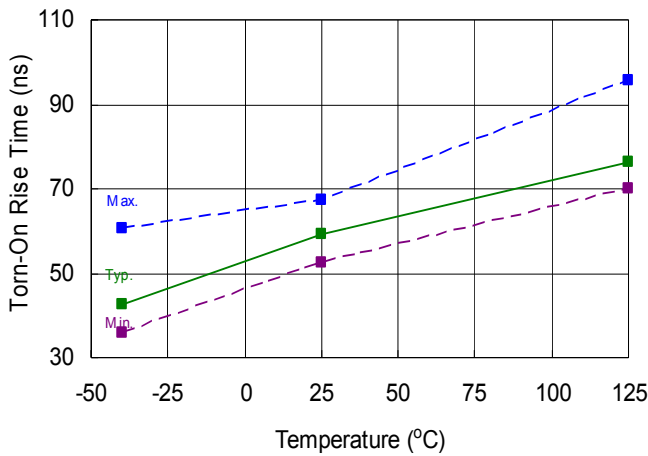
**Figure 10A.** Shutdown Delay Time vs. Temperature



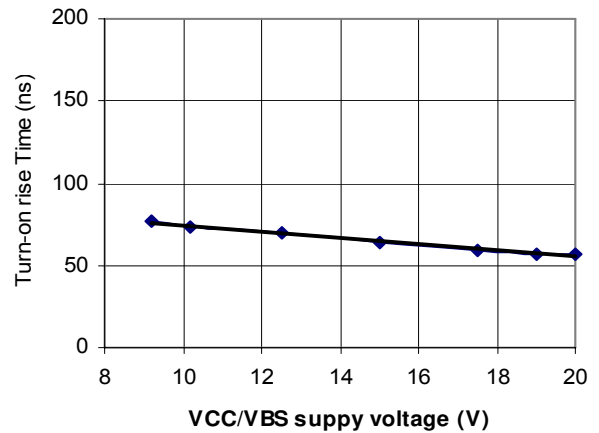
**Figure 10B.** Shutdown Delay Time vs. V<sub>CC</sub>/V<sub>BS</sub> Supply Voltage



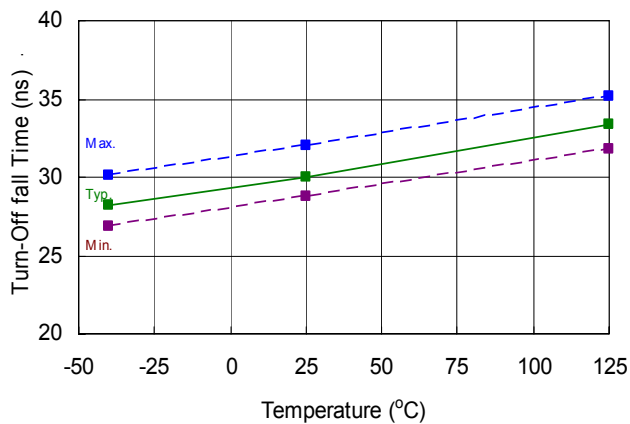
**Figure 10C.** Shutdown Delay Time vs. V<sub>DD</sub> Supply Voltage



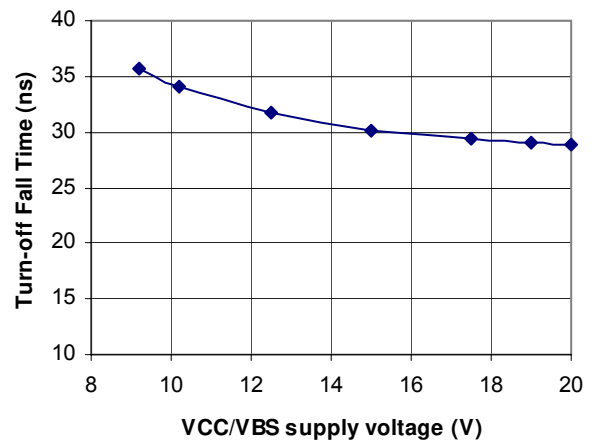
**Figure 11A.** Turn-on Rise Time vs. Temperature



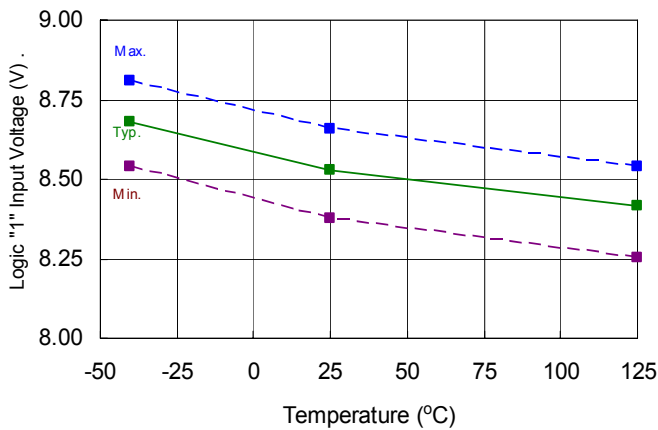
**Figure 11B.** Turn-on Rise Time vs. Voltage



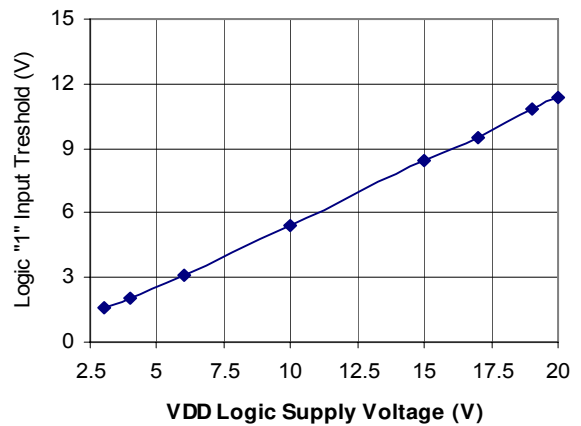
**Figure 12A.** Turn-off Fall Time vs. Temperature



**Figure 12B.** Turn-off Fall Time vs. Voltage



**Figure 13A.** Logic "1" Input Threshold vs. Temperature



**Figure 13B.** Logic "1" Input Threshold vs. Voltage



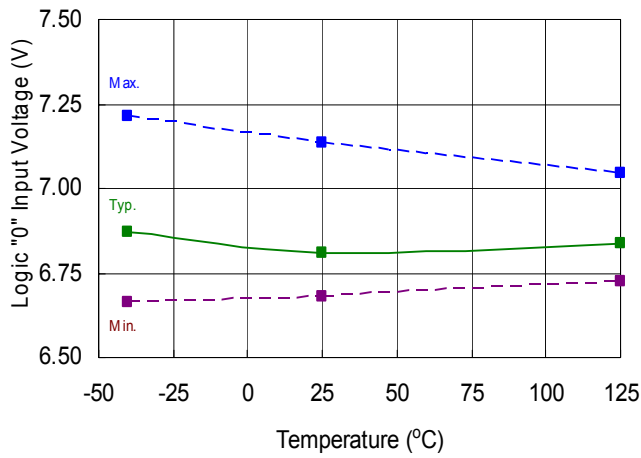


Figure 14A. Logic "0" Input Threshold vs. Temperature

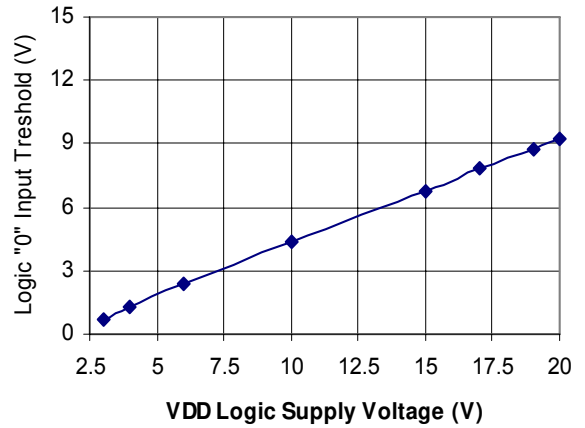


Figure 14B. Logic "0" Input Threshold vs. Voltage

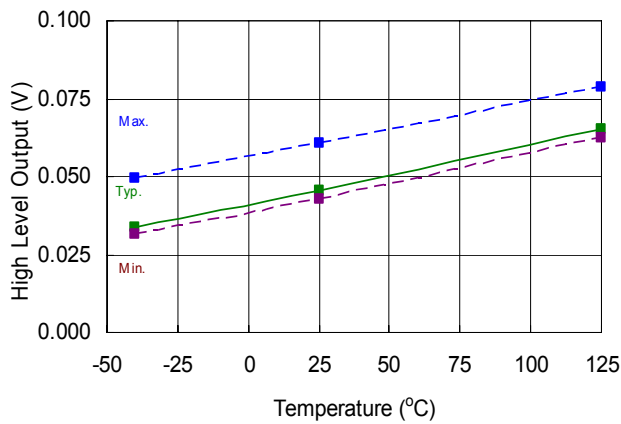


Figure 15. High Level Output Voltage vs. Temperature (I<sub>O</sub> = 2 mA)

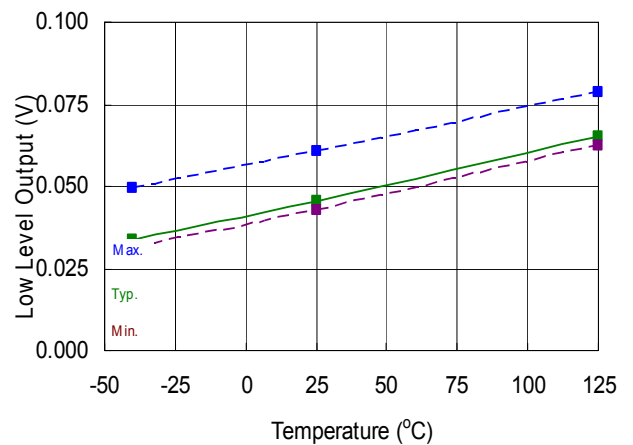


Figure 16. Low Level Output Voltage vs. Temperature (I<sub>O</sub> = 2 mA)

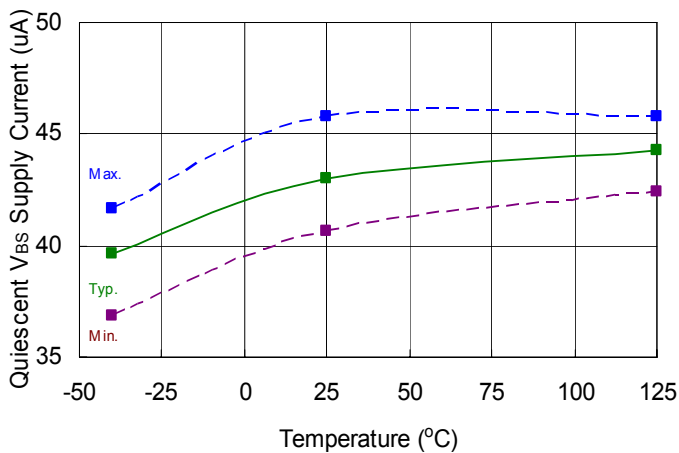


Figure 17A. V<sub>BS</sub> Supply Current vs. Temperature

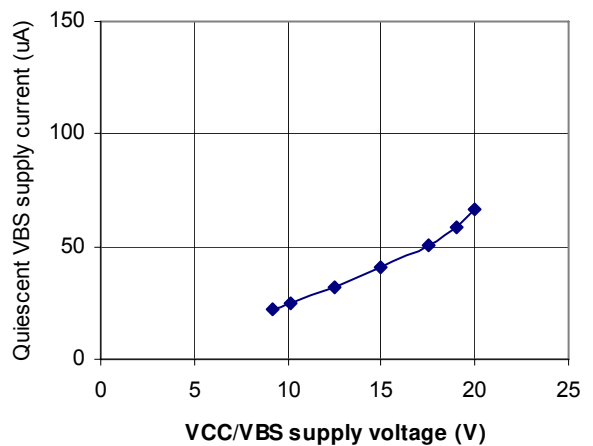
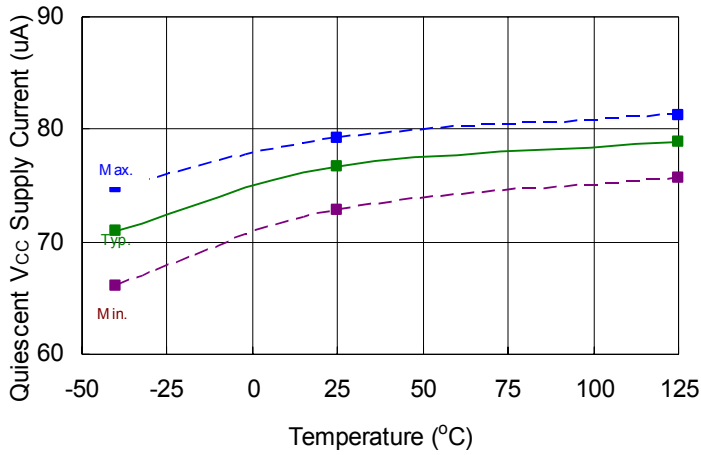
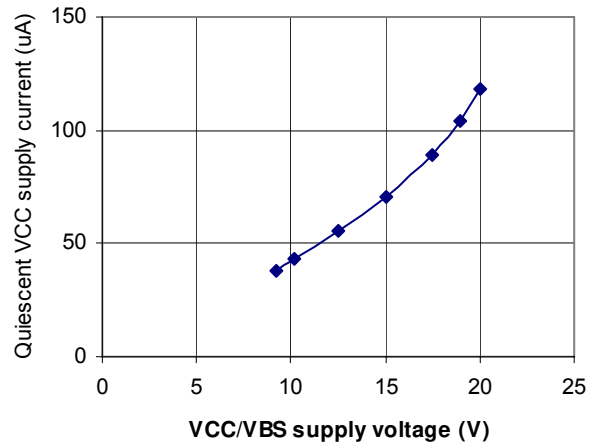


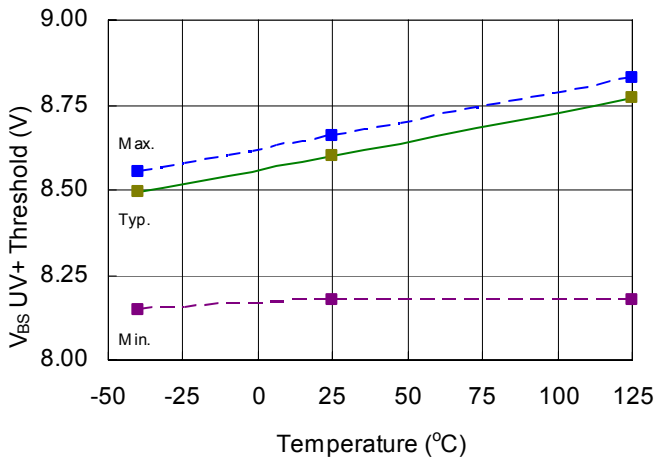
Figure 17B. V<sub>BS</sub> Supply Current vs. Voltage



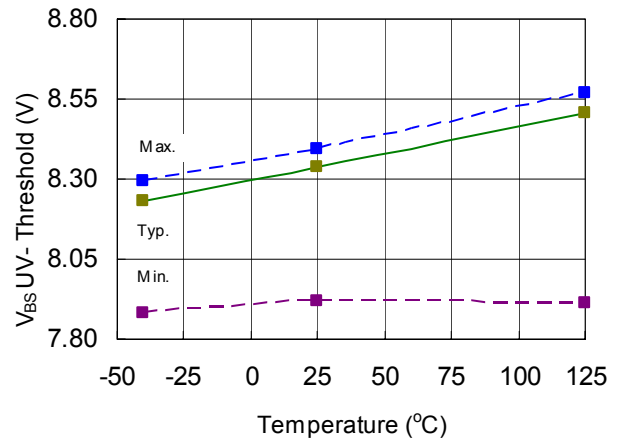
**Figure 18A.**  $V_{CC}$  Supply Current vs. Temperature



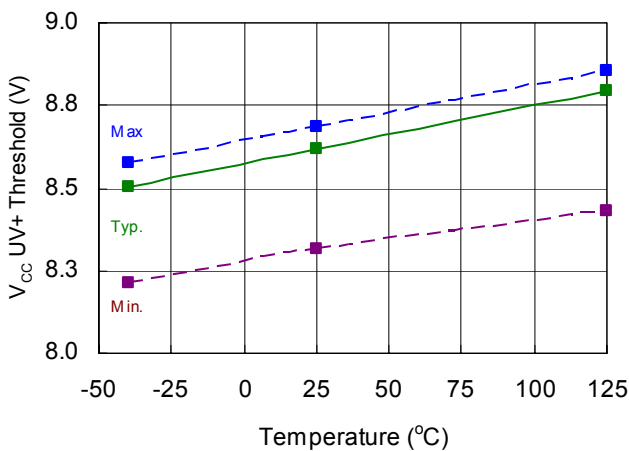
**Figure 18B.**  $V_{CC}$  Supply Current vs. Voltage



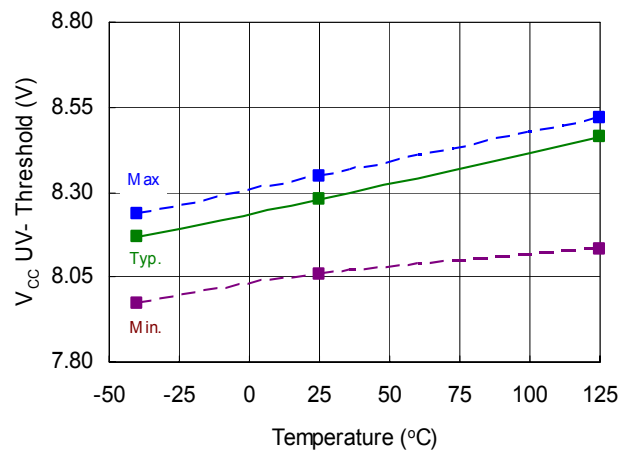
**Figure 19.**  $V_{BS}$  Undervoltage (+) vs. Temperature



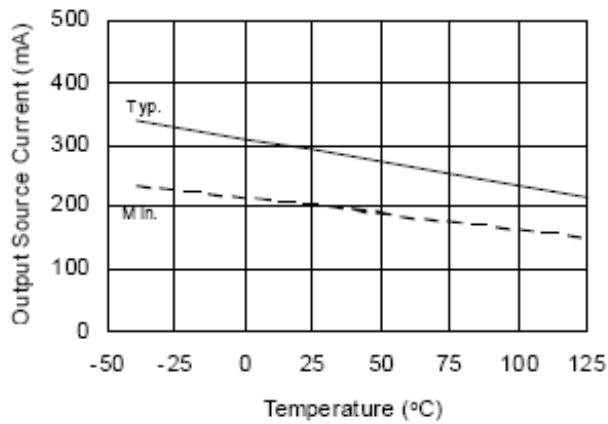
**Figure 20.**  $V_{BS}$  Undervoltage (-) vs. Temperature



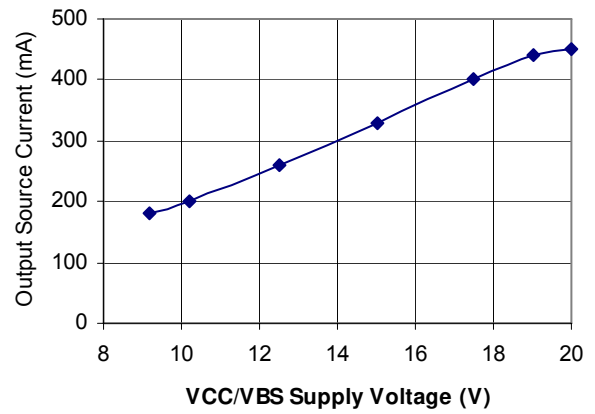
**Figure 21.**  $V_{CC}$  Undervoltage (+) vs. Temperature



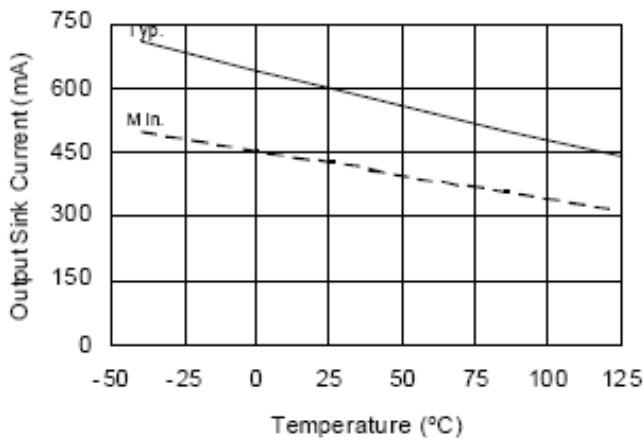
**Figure 22.**  $V_{CC}$  Undervoltage (-) vs. Temperature



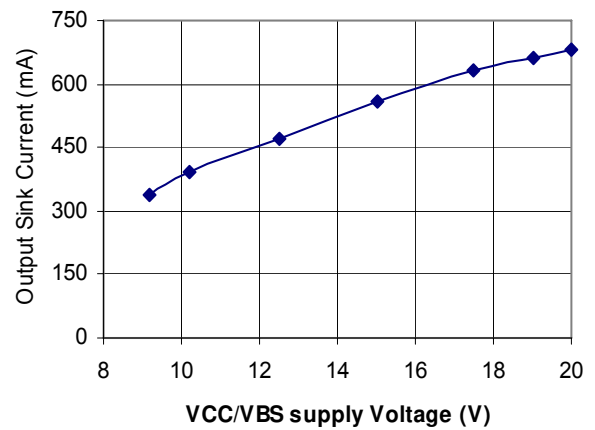
**Figure 23A.** Output Source Current vs. Temperature



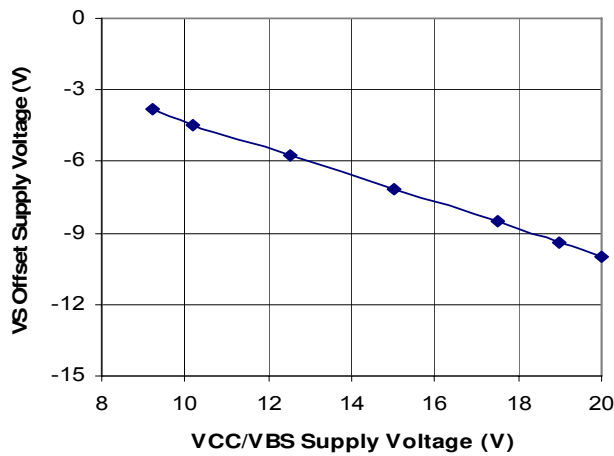
**Figure 23B.** Output Source Current vs. Supply Voltage



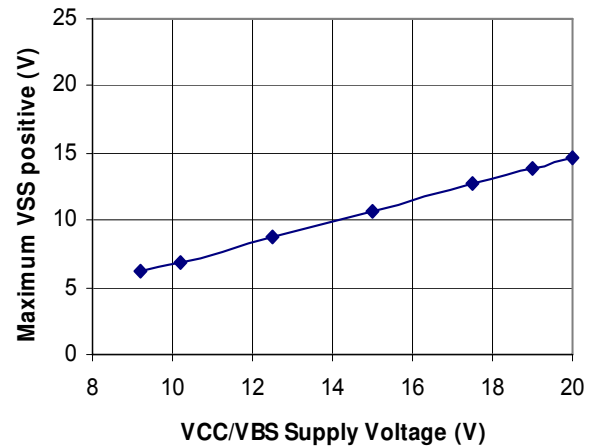
**Figure 24A.** Output Sink Current vs. Temperature



**Figure 24B.** Output Sink Current vs. Supply Voltage

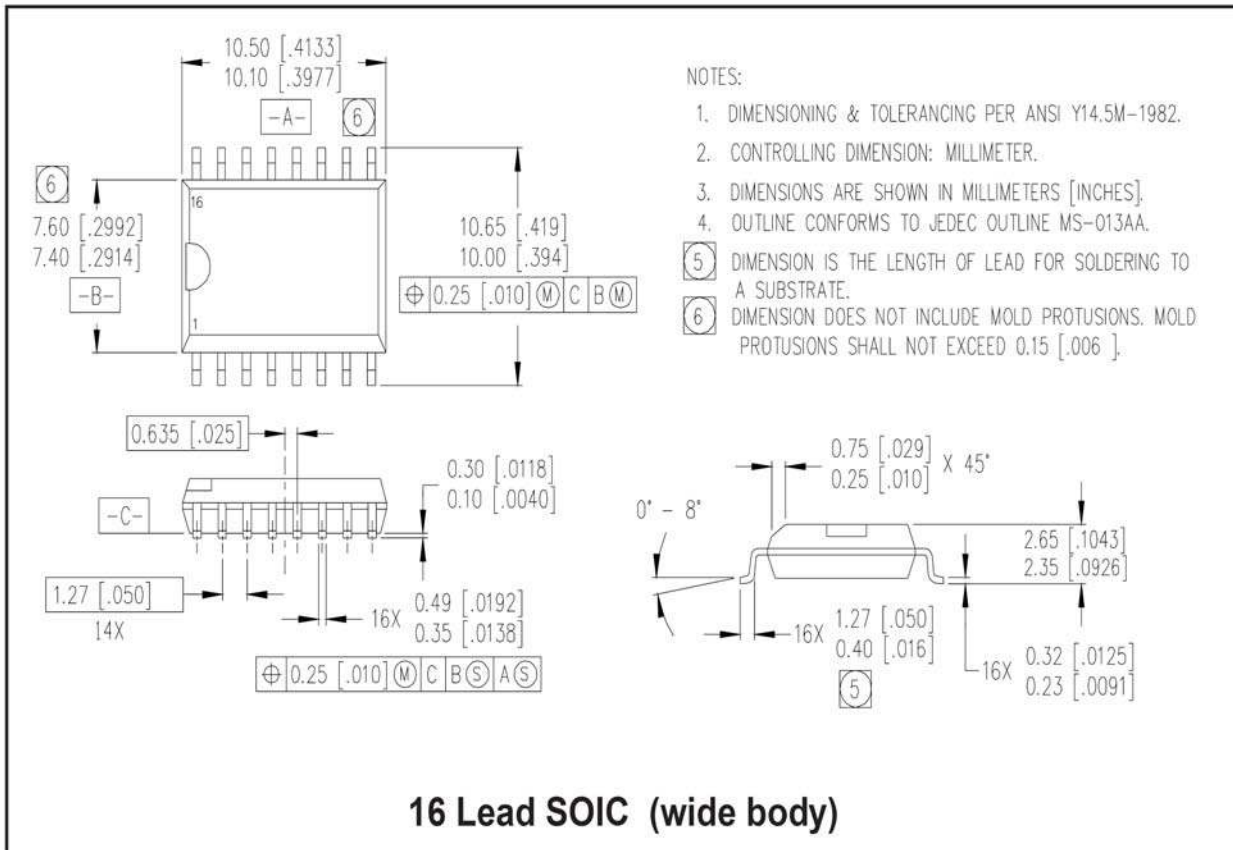


**Figure 25.** Maximum  $V_S$  Negative Offset vs VCC/VBS Supply Voltage

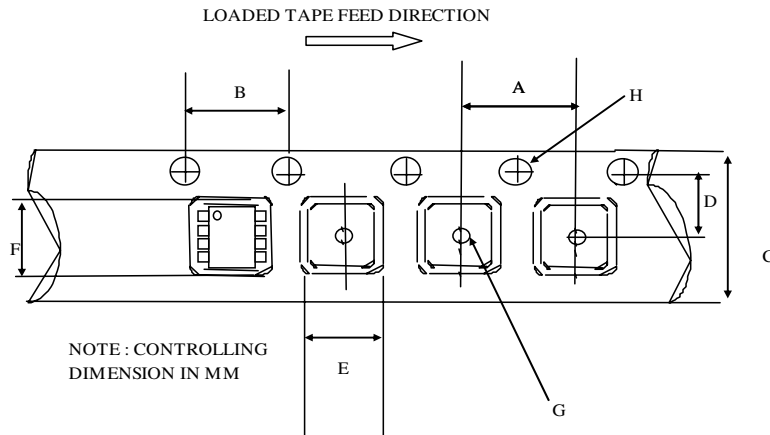


**Figure 26.** Maximum  $V_{SS}$  Positive Offset vs VCC/VBS Supply Voltage

**Package Details: SOIC16W**

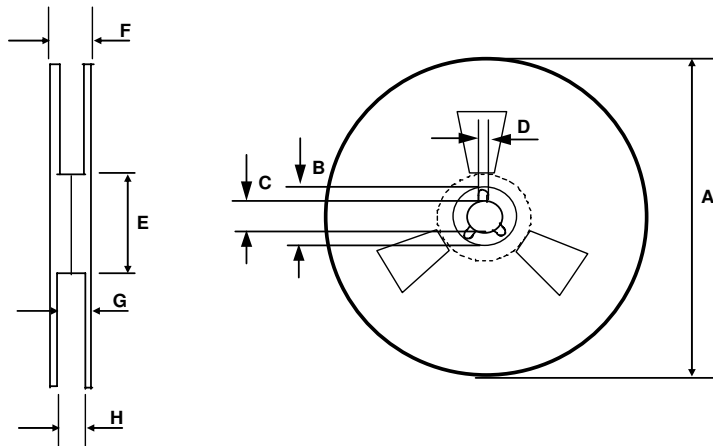


**Tape and Reel Details: SOIC16W**



**CARRIER TAPE DIMENSION FOR 16SOICW**

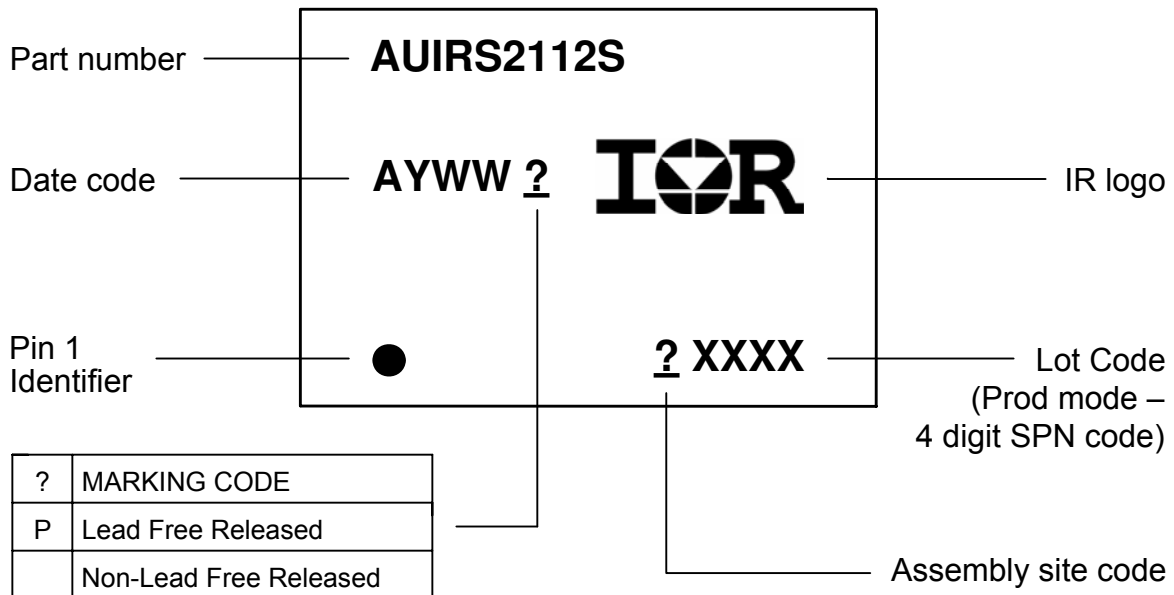
Code	Metric		Imperial	
	Min	Max	Min	Max
A	11.90	12.10	0.468	0.476
B	3.90	4.10	0.153	0.161
C	15.70	16.30	0.618	0.641
D	7.40	7.60	0.291	0.299
E	10.80	11.00	0.425	0.433
F	10.60	10.80	0.417	0.425
G	1.50	n/a	0.059	n/a
H	1.50	1.60	0.059	0.062



**REEL DIMENSIONS FOR 16SOICW**

Code	Metric		Imperial	
	Min	Max	Min	Max
A	329.60	330.25	12.976	13.001
B	20.95	21.45	0.824	0.844
C	12.80	13.20	0.503	0.519
D	1.95	2.45	0.767	0.096
E	98.00	102.00	3.858	4.015
F	n/a	22.40	n/a	0.881
G	18.50	21.10	0.728	0.830
H	16.40	18.40	0.645	0.724

**Part Marking Information**



**Ordering Information**

Base Part Number	Package Type	Standard Pack		Complete Part Number
		Form	Quantity	
AUIRS2112S	SOIC16W	Tube/Bulk	45	AUIRS2112S
		Tape and Reel	1000	AUIRS2112STR

## **IMPORTANT NOTICE**

Unless specifically designated for the automotive market, International Rectifier Corporation and its subsidiaries (IR) reserve the right to make corrections, modifications, enhancements, improvements, and other changes to its products and services at any time and to discontinue any product or services without notice. Part numbers designated with the "AU" prefix follow automotive industry and / or customer specific requirements with regards to product discontinuance and process change notification. All products are sold subject to IR's terms and conditions of sale supplied at the time of order acknowledgment.

IR warrants performance of its hardware products to the specifications applicable at the time of sale in accordance with IR's standard warranty. Testing and other quality control techniques are used to the extent IR deems necessary to support this warranty. Except where mandated by government requirements, testing of all parameters of each product is not necessarily performed.

IR assumes no liability for applications assistance or customer product design. Customers are responsible for their products and applications using IR components. To minimize the risks with customer products and applications, customers should provide adequate design and operating safeguards.

Reproduction of IR information in IR data books or data sheets is permissible only if reproduction is without alteration and is accompanied by all associated warranties, conditions, limitations, and notices. Reproduction of this information with alterations is an unfair and deceptive business practice. IR is not responsible or liable for such altered documentation. Information of third parties may be subject to additional restrictions.

Resale of IR products or serviced with statements different from or beyond the parameters stated by IR for that product or service voids all express and any implied warranties for the associated IR product or service and is an unfair and deceptive business practice. IR is not responsible or liable for any such statements.

IR products are not designed, intended, or authorized for use as components in systems intended for surgical implant into the body, or in other applications intended to support or sustain life, or in any other application in which the failure of the IR product could create a situation where personal injury or death may occur. Should Buyer purchase or use IR products for any such unintended or unauthorized application, Buyer shall indemnify and hold International Rectifier and its officers, employees, subsidiaries, affiliates, and distributors harmless against all claims, costs, damages, and expenses, and reasonable attorney fees arising out of, directly or indirectly, any claim of personal injury or death associated with such unintended or unauthorized use, even if such claim alleges that IR was negligent regarding the design or manufacture of the product.

Only products certified as military grade by the Defense Logistics Agency (DLA) of the US Department of Defense, are designed and manufactured to meet DLA military specifications required by certain military, aerospace or other applications. Buyers acknowledge and agree that any use of IR products not certified by DLA as military-grade, in applications requiring military grade products, is solely at the Buyer's own risk and that they are solely responsible for compliance with all legal and regulatory requirements in connection with such use.

IR products are neither designed nor intended for use in automotive applications or environments unless the specific IR products are designated by IR as compliant with ISO/TS 16949 requirements and bear a part number including the designation "AU". Buyers acknowledge and agree that, if they use any non-designated products in automotive applications, IR will not be responsible for any failure to meet such requirements.

For technical support, please contact IR's Technical Assistance Center  
<http://www.irf.com/technical-info/>

**WORLD HEADQUARTERS:**

101 N. Sepulveda Blvd., El Segundo, California 90245  
Tel: (310) 252-7105