

RMB15A

RMB 15A -1 -□

① ② ③ ④

c **UL** us
RoHS

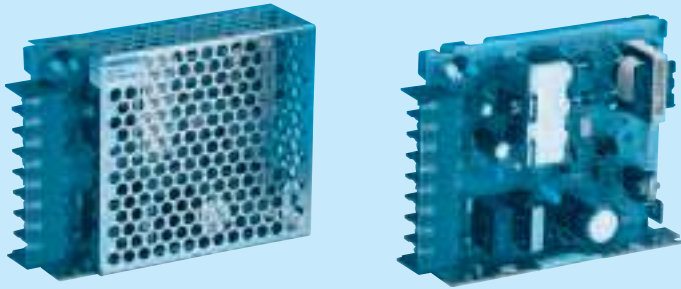

- ① Series name
- ② Output wattage
- ③ Output voltage combination
- ④ Optional *1
J : Connector type
N : with Cover

MODEL	RMB15A-1		RMB15A-2	
DC OUTPUT	V1	+5V 0.8A	+5V 0.8A	
	V2	+12V 1.0(Peak 1.3)A	+24V 0.5(Peak 0.65)A	

SPECIFICATIONS

	MODEL	RMB15A-1		RMB15A-2		
INPUT	VOLTAGE[V]	AC85 - 132 1 φ or DC110 - 170				
	CURRENT[A]	ACIN 100V	0.45typ (Io=100%)			
	FREQUENCY[Hz]	47 - 440 or DC				
	EFFICIENCY[%]	ACIN 100V	68typ (Io=100%)			
	INRUSH CURRENT[A]	ACIN 100V	20typ (Io=100%) (At cold start)			
OUTPUT	VOLTAGE[V]	+5	+12	+5	+24	
	CURRENT[A]	0 - 0.8	0 - 1.0 (Peak 1.3)	0 - 0.8	0 - 0.5 (Peak 0.65)	
	LINE REGULATION[mV]	20max	48max	20max	96max	
	LOAD REGULATION[mV]	150max	100max	150max	150max	
	RIPPLE[mVp-p]	0 to +50°C	100max	120max	100max	120max
		-10 - 0°C	140max	160max	140max	160max
	RIPPLE NOISE[mVp-p]	0 to +50°C	120max	150max	120max	150max
		-10 - 0°C	160max	180max	160max	180max
	TEMPERATURE REGULATION[mV]	0 to +50°C	150max	120max	150max	240max
		-10 to +50°C	180max	150max	180max	290max
	START-UP TIME[ms]	100max (ACIN 85V, Io=100%)				
HOLD-UP TIME[ms]	10typ (ACIN 85V, Io=100%, 0 to +50°C) 20typ (ACIN 100V, Io=100%, 0 to +50°C)					
OUTPUT VOLTAGE ADJUSTMENT RANGE[V]	5.00 - 5.25	Fixed	5.00 - 5.25	Fixed		
OUTPUT VOLTAGE SETTING[V]	—	11.40 - 12.60	—	22.80 - 25.20		
PROTECTION CIRCUIT AND OTHERS	OVERCURRENT PROTECTION	Works over 105% of rating (peak current for V2) and recovers automatically				
	OVERVOLTAGE PROTECTION	By zener diode clamping (+5V)				
	OPERATING INDICATION	LED (Green)				
ISOLATION	INPUT-OUTPUT	AC2,000V 1minute, DC500V 50MΩmin (At Room Temperature)				
	INPUT-FG, COVER	AC2,000V 1minute, DC500V 50MΩmin (At Room Temperature)				
	OUTPUT-FG, COVER	AC500V 1minute, DC500V 50MΩmin (At Room Temperature)				
	OUTPUT-OUTPUT(V1-V2)	AC100V 1minute, DC100V 10MΩmin (At Room Temperature)				
ENVIRONMENT	OPERATING TEMP.,HUMID.AND ALTITUDE	-10 to +60°C, 20 - 90%RH (Non condensing) (Refer to DERATING CURVE), 3,000m (10,000feet) max				
	STORAGE TEMP.,HUMID.AND ALTITUDE	-20 to +75°C, 20 - 90%RH (Non condensing), 9,000m (30,000feet) max				
	VIBRATION	10 - 55Hz, 19.6m/s ² (2G), 3minutes period, 60minutes each along X, Y and Z axis				
	IMPACT	196.1m/s ² (20G), 11ms, once each X, Y and Z axis				
SAFETY AND NOISE REGULATIONS	AGENCY APPROVALS	UL60950-1, C-UL Complies with DEN-AN				
	CONDUCTED NOISE	Complies with FCC-B, VCCI-B				
OTHERS	CASE SIZE/WEIGHT	28 × 80 × 100mm (W × H × D) /250g max (without cover)				
	COOLING METHOD	Convection				

- *1 Please contact us about safety approvals for the model with option.
- * Avoid prolonged use under over-load.
- * Series/Parallel operation with other model is not possible.
- * Derating is required when operated with case cover.

External view

RMB

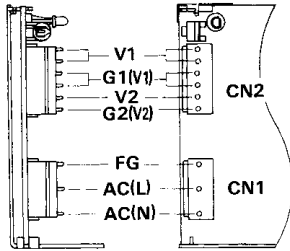

I/O Connector	Mating Connector
CN1	B3P5-VH
CN2	B6P-VH

(Mfr: J.S.T.)

Terminal
Chain : SVH-21-P1.1
Loose : BVH-21-P1.1

(Mfr: J.S.T.)

Connector type

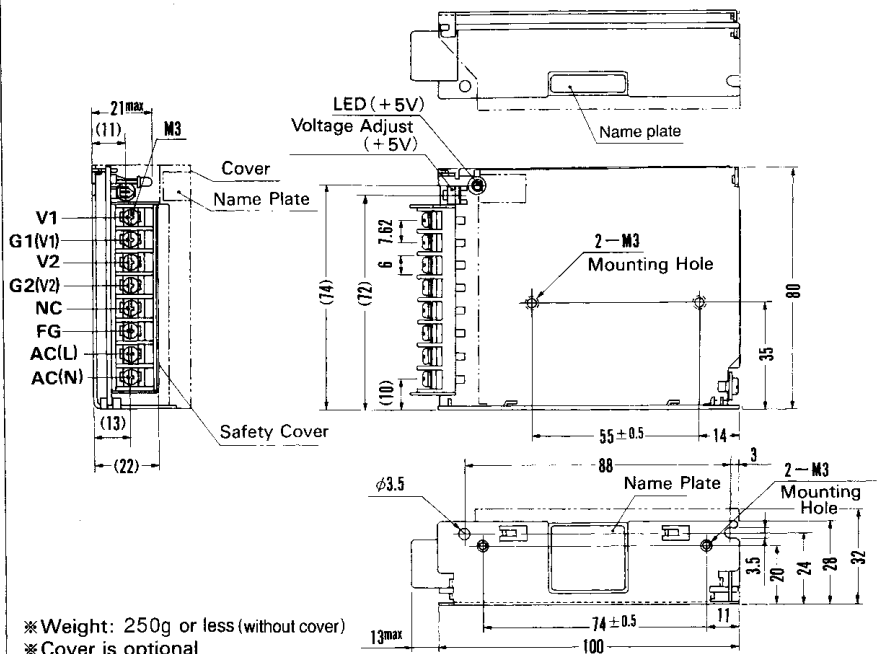

- ※ Weight: 250g or less (without cover)
- ※ Cover is optional
- ※ Tolerance: ± 1
- ※ Dimensions in mm.

Barrier strip type

※ Mounting torque : 0.6N·m (6.3kgf·cm) max

Performance data

■ STATIC CHARACTERISTICS (RMB15A-1)

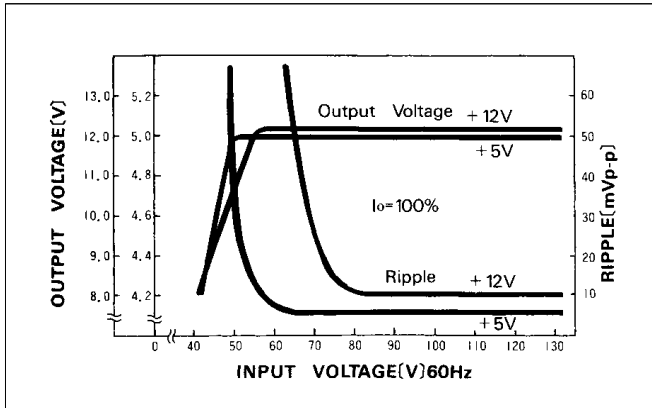

■ RISE TIME & FALL TIME (RMB15A-1)

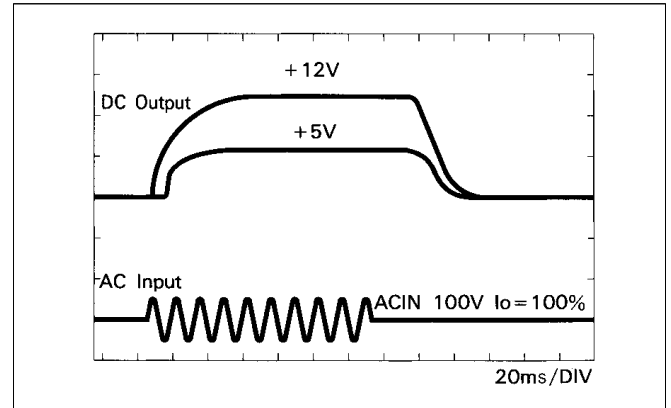

■ OVERCURRENT CHARACTERISTICS (RMB15A-1)

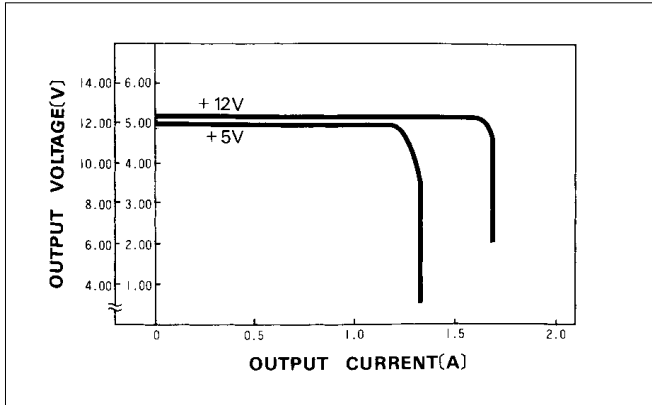

■ DERATING CURVE

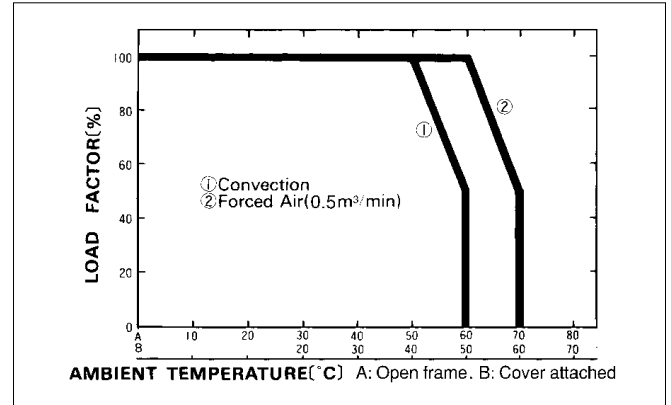

RMB30A

RMB 30A -1 -□

① ② ③ ④

c  us
RoHS

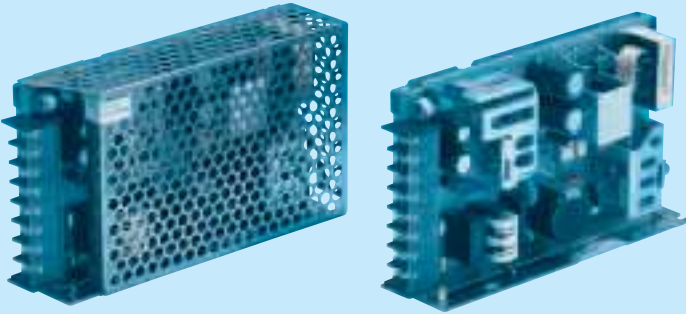

- ① Series name
- ② Output wattage
- ③ Output voltage combination
- ④ Optional *1
J : Connector type
N : with Cover

MODEL	RMB30A-1		RMB30A-2	
DC OUTPUT	V1	+5V 1.5A	+5V 1.5A	
	V2	+12V 2.0(Peak 2.8)A	+24V 1.0(Peak 1.4)A	

SPECIFICATIONS

	MODEL	RMB30A-1		RMB30A-2		
INPUT	VOLTAGE[V]	AC85 - 132 1 φ or DC110 - 170				
	CURRENT[A]	ACIN 100V	0.9typ (Io=100%)			
	FREQUENCY[Hz]	47 - 440 or DC				
	EFFICIENCY[%]	ACIN 100V	69typ (Io=100%)			
	INRUSH CURRENT[A]	ACIN 100V	30typ (Io=100%) (At cold start)			
OUTPUT	VOLTAGE[V]	+5	+12	+5	+24	
	CURRENT[A]	0 - 1.5	0 - 2.0 (Peak 2.8)	0 - 1.5	0 - 1.0 (Peak 1.4)	
	LINE REGULATION[mV]	20max	48max	20max	96max	
	LOAD REGULATION[mV]	150max	100max	150max	150max	
	RIPPLE[mVp-p]	0 to +50°C	100max	120max	100max	120max
		-10 - 0°C	140max	160max	140max	160max
	RIPPLE NOISE[mVp-p]	0 to +50°C	120max	150max	120max	150max
		-10 - 0°C	160max	180max	160max	180max
	TEMPERATURE REGULATION[mV]	0 to +50°C	150max	120max	150max	240max
		-10 to +50°C	180max	150max	180max	290max
START-UP TIME[ms]	100max (ACIN 85V, Io=100%)					
HOLD-UP TIME[ms]	10typ (ACIN 85V, Io=100%, 0 to +50°C) 20typ (ACIN 100V, Io=100%, 0 to +50°C)					
OUTPUT VOLTAGE ADJUSTMENT RANGE[V]	5.00 - 5.25	Fixed	5.00 - 5.25	Fixed		
OUTPUT VOLTAGE SETTING[V]	—	11.40 - 12.60	—	22.80 - 25.20		
PROTECTION CIRCUIT AND OTHERS	OVERCURRENT PROTECTION	Works over 105% of rating (peak current for V2) and recovers automatically				
	OVERVOLTAGE PROTECTION	Works at 115 - 140% of rating (+5V)				
	OPERATING INDICATION	LED (Green)				
ISOLATION	INPUT-OUTPUT	AC2,000V 1minute, DC500V 50MΩmin (At Room Temperature)				
	INPUT-FG, COVER	AC2,000V 1minute, DC500V 50MΩmin (At Room Temperature)				
	OUTPUT-FG, COVER	AC500V 1minute, DC500V 50MΩmin (At Room Temperature)				
	OUTPUT-OUTPUT(V1-V2)	AC100V 1minute, DC100V 10MΩmin (At Room Temperature)				
ENVIRONMENT	OPERATING TEMP.,HUMID.AND ALTITUDE	-10 to +60°C, 20 - 90%RH (Non condensing) (Refer to DERATING CURVE), 3,000m (10,000feet) max				
	STORAGE TEMP.,HUMID.AND ALTITUDE	-20 to +75°C, 20 - 90%RH (Non condensing), 9,000m (30,000feet) max				
	VIBRATION	10 - 55Hz, 19.6m/s ² (2G), 3minutes period, 60minutes each along X, Y and Z axis				
	IMPACT	196.1m/s ² (20G), 11ms, once each X, Y and Z axis				
SAFETY AND NOISE REGULATIONS	AGENCY APPROVALS	UL60950-1, C-UL Complies with DEN-AN				
	CONDUCTED NOISE	Complies with FCC-B, VCCI-B				
OTHERS	CASE SIZE/WEIGHT	31 × 80 × 135mm (W × H × D) /350g max (without cover)				
	COOLING METHOD	Convection				

- *1 Please contact us about safety approvals for the model with option.
- * Avoid prolonged use under over-load.
- * Series/Parallel operation with other model is not possible.
- * Derating is required when operated with case cover.

External view

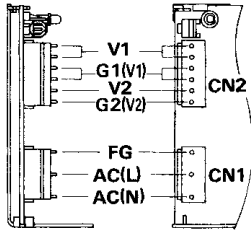

I/O Connector	Mating Connector
CN1	B3P5-VH
CN2	B6P-VH

(Mfr.: J.S.T.)

Terminal
Chain : SVH-21-P1.1
Loose : BVH-21-P1.1

(Mfr.: J.S.T.)

Connector type

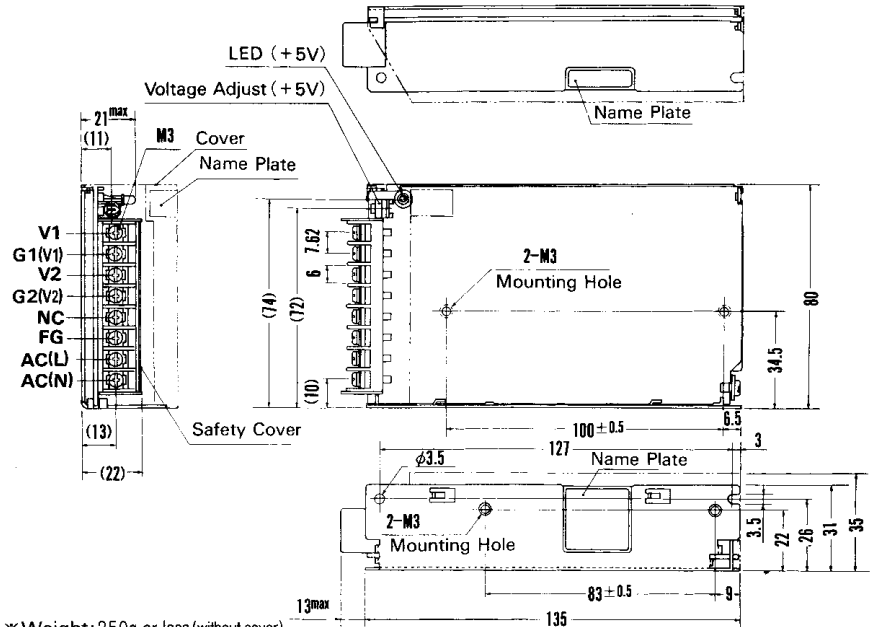

- *Weight: 350g or less (without cover)
- *Cover is optional
- *Tolerance: ± 1
- *Dimensions in mm.

*Mounting torque : 0.6N·m (6.3kgf·cm) max

Barrier strip type

Performance data

■ STATIC CHARACTERISTICS (RMB30A-1)

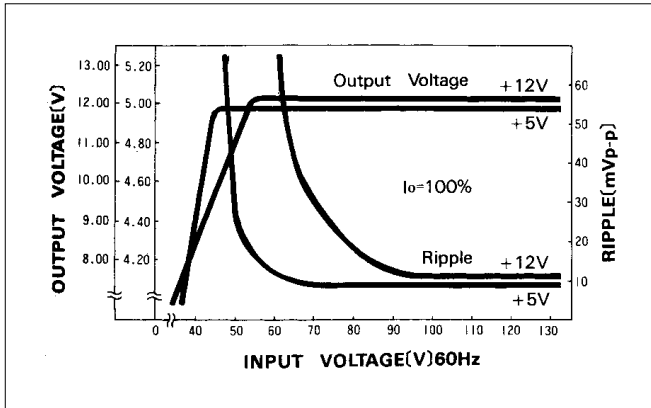

■ RISE TIME & FALL TIME (RMB30A-1)

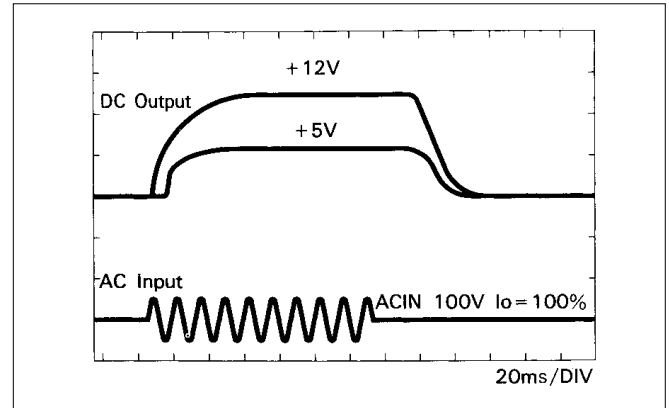

■ OVERCURRENT CHARACTERISTICS (RMB30A-1)

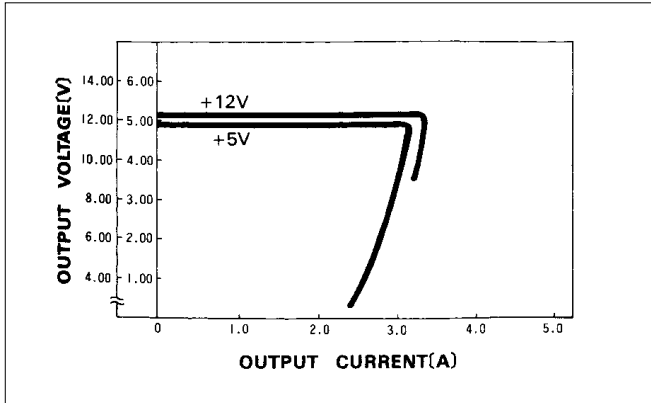

■ DERATING CURVE

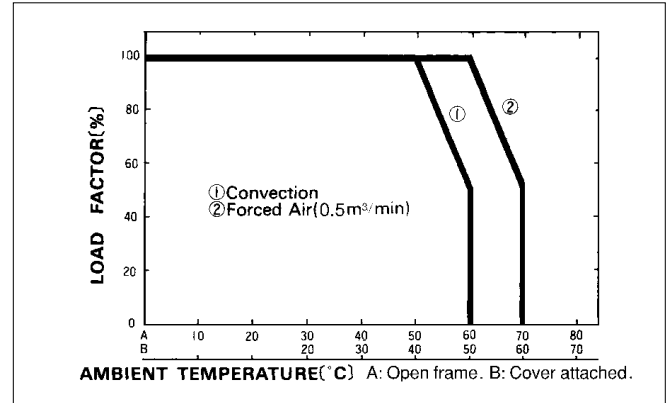

RMB50A

RMB 50A -1 -□

① ② ③ ④

c  us
RoHS

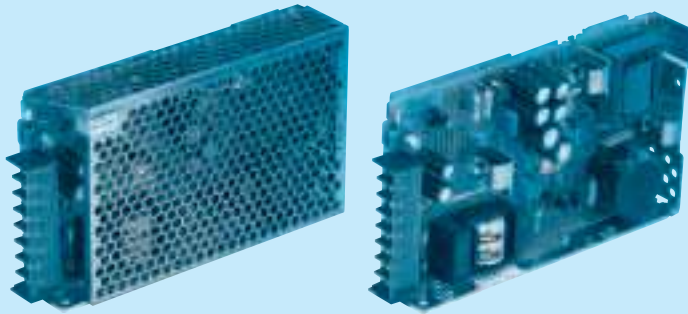

- ① Series name
- ② Output wattage
- ③ Output voltage combination
- ④ Optional *1
G :Low leakage current
J :Connector type
N :with Cover

MODEL	RMB50A-1		RMB50A-2	
DC OUTPUT	V1	+5V 1.5A	+5V 1.5A	
	V2	+12V 3.6(Peak 4)A	+24V 1.8(Peak 2)A	

SPECIFICATIONS

	MODEL	RMB50A-1		RMB50A-2		
INPUT	VOLTAGE[V]	AC85 - 132 1 φ or DC110 - 170				
	CURRENT[A]	ACIN 100V	1.4typ (Io=100%)			
	FREQUENCY[Hz]	47 - 440 or DC				
	EFFICIENCY[%]	ACIN 100V	74typ (Io=100%)			
	INRUSH CURRENT[A]	ACIN 100V	30typ (Io=100%) (At cold start)			
OUTPUT	VOLTAGE[V]	+5	+12	+5	+24	
	CURRENT[A]	0 - 1.5	0 - 3.6 (Peak 4)	0 - 1.5	0 - 1.8 (Peak 2)	
	LINE REGULATION[mV]	20max	48max	20max	96max	
	LOAD REGULATION[mV]	150max	100max	150max	150max	
	RIPPLE[mVp-p]	0 to +50°C	80max	120max	80max	120max
		-10 - 0°C	140max	160max	140max	160max
	RIPPLE NOISE[mVp-p]	0 to +50°C	120max	150max	120max	150max
		-10 - 0°C	160max	180max	160max	180max
	TEMPERATURE REGULATION[mV]	0 to +50°C	150max	120max	150max	240max
		-10 to +50°C	180max	150max	180max	290max
START-UP TIME[ms]	100max (ACIN 85V, Io=100%)					
HOLD-UP TIME[ms]	10typ (ACIN 85V, Io=100%, 0 to +50°C) 20typ (ACIN 100V, Io=100%, 0 to +50°C)					
OUTPUT VOLTAGE ADJUSTMENT RANGE[V]	5.00 - 5.25	Fixed	5.00 - 5.25	Fixed		
OUTPUT VOLTAGE SETTING[V]	—	11.40 - 12.60	—	22.80 - 25.20		
PROTECTION CIRCUIT AND OTHERS	OVERCURRENT PROTECTION	Works over 105% of rating (peak current for V2) and recovers automatically				
	OVERVOLTAGE PROTECTION	Works at 115 - 140% of rating (+5V)				
	OPERATING INDICATION	LED (Green)				
ISOLATION	INPUT-OUTPUT	AC2,000V 1minute, DC500V 50MΩmin (At Room Temperature)				
	INPUT-FG, COVER	AC2,000V 1minute, DC500V 50MΩmin (At Room Temperature)				
	OUTPUT-FG, COVER	AC500V 1minute, DC500V 50MΩmin (At Room Temperature)				
	OUTPUT-OUTPUT(V1-V2)	AC100V 1minute, DC100V 10MΩmin (At Room Temperature)				
ENVIRONMENT	OPERATING TEMP.,HUMID.AND ALTITUDE	-10 to +65°C, 20 - 90%RH (Non condensing) (Refer to DERATING CURVE), 3,000m (10,000feet) max				
	STORAGE TEMP.,HUMID.AND ALTITUDE	-20 to +75°C, 20 - 90%RH (Non condensing), 9,000m (30,000feet) max				
	VIBRATION	10 - 55Hz, 19.6m/s ² (2G), 3minutes period, 60minutes each along X, Y and Z axis				
	IMPACT	196.1m/s ² (20G), 11ms, once each X, Y and Z axis				
SAFETY AND NOISE REGULATIONS	AGENCY APPROVALS	UL60950-1, C-UL Complies with DEN-AN				
	CONDUCTED NOISE	Complies with FCC-B, VCCI-B				
OTHERS	CASE SIZE/WEIGHT	31 × 93 × 155mm (W × H × D) /350g max (without cover)				
	COOLING METHOD	Convection				

*1 Please contact us about safety approvals for the model with option.
* Avoid prolonged use under over-load.
* Series/Parallel operation with other model is not possible.
* Derating is required when operated with case cover.

External view

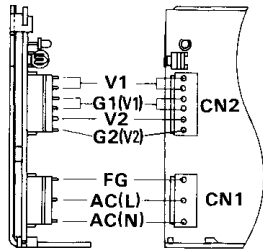

I/O Connector	Mating Connector
CN1	B3P5-VH VHR-5N
CN2	B6P-VH VHR-6N

(Mfr: J.S.T.)

Terminal
Chain : SVH-21-P1.1
Loose : BVH-21-P1.1

(Mfr: J.S.T.)

Connector type

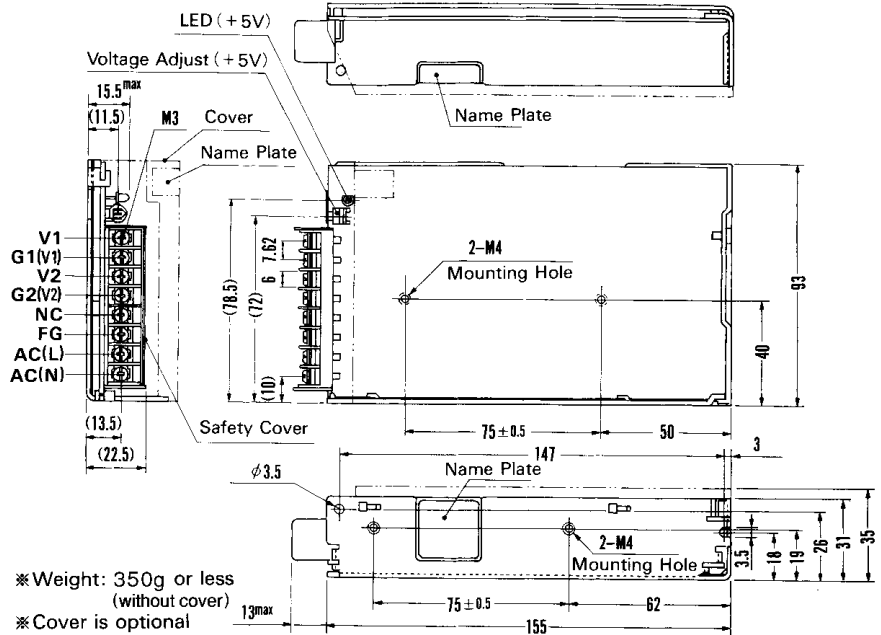

- ※ Weight: 350g or less (without cover)
- ※ Cover is optional
- ※ Tolerance: ± 1
- ※ Dimensions in mm.

※ Mounting torque : 1.2N·m (12.8kgf·cm) max

Barrier strip type

Performance data

■ STATIC CHARACTERISTICS (RMB50A-1)

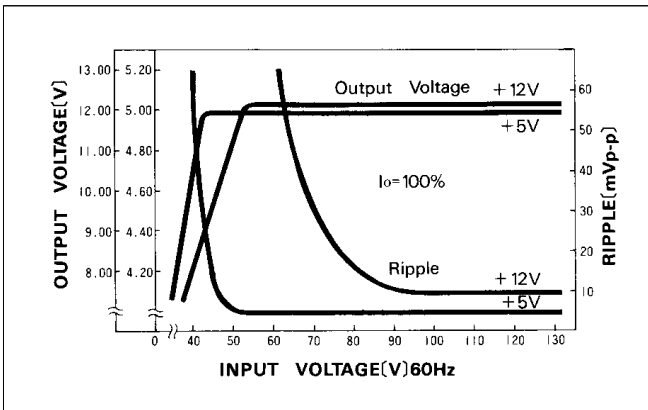

■ RISE TIME & FALL TIME (RMB50A-1)

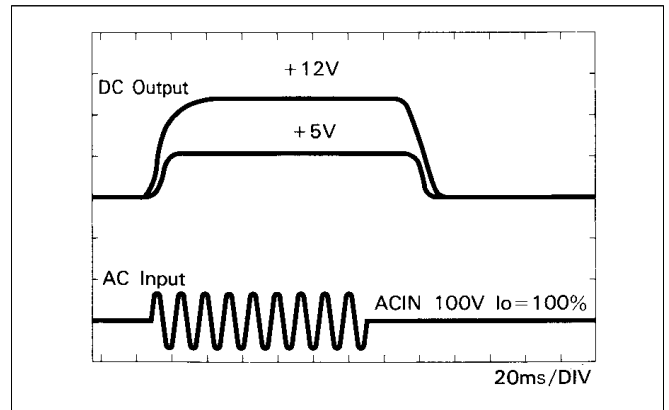

■ OVERCURRENT CHARACTERISTICS (RMB50A-1)

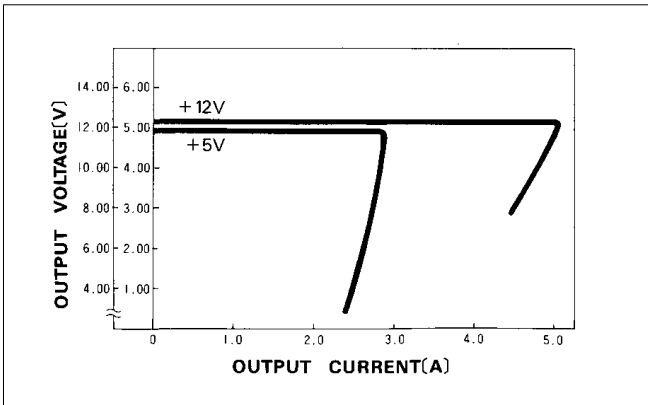

■ DERATING CURVE

