

Hyperfast Rectifier, 2 x 15 A FRED Pt® G5

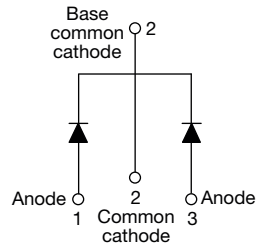

FEATURES

- Hyperfast and optimized Q_{rr}
- Best in class forward voltage drop and switching losses trade off
- Optimized for high speed operation
- 175 °C maximum operating junction temperature
- Polyimide passivation
- Material categorization: for definitions of compliance please see www.vishay.com/doc?99912

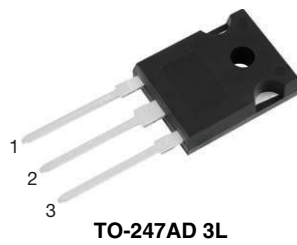

RoHS
COMPLIANT
HALOGEN
FREE

LINKS TO ADDITIONAL RESOURCES



PRIMARY CHARACTERISTICS	
$I_{F(AV)}$, per leg	15 A
V_R	1200 V
V_F at I_F at 125 °C	2.1 V
t_{rr}	29 ns
T_J max.	175 °C
Package	TO-247AD 3L
Circuit configuration	Common cathode

DESCRIPTION / APPLICATIONS

Featuring a unique combination of low conduction and switching losses, this rectifier is the right choice for high frequency converters, both soft switched / resonant. Specifically designed to improve efficiency of PFC and output rectification stages of EV / HEV battery charging stations, booster stage of solar inverters and UPS applications, these devices are perfectly matched to operate with MOSFETs or high speed IGBTs.

MECHANICAL DATA

Case: TO-247AD 3L

Molding compound meets UL 94 V-0 flammability rating

Terminals: matte tin plated leads, solderable per J-STD-002

Polarity: as per marking device details

ABSOLUTE MAXIMUM RATINGS				
PARAMETER	SYMBOL	TEST CONDITIONS	VALUES	UNITS
Repetitive peak reverse voltage, per leg	V_{RRM}		1200	V
Average rectified forward current, per leg	$I_{F(AV)}$	$T_C = 111\text{ °C}$, $D = 0.50$	15	A
Repetitive peak forward current, per leg	I_{FRM}	$T_C = 111\text{ °C}$, $D = 0.50$, $f = 20\text{ kHz}$	30	
Non-repetitive peak surge current, per leg	I_{FSM}	$T_C = 45\text{ °C}$, $t_p = 10\text{ ms}$, sine wave	110	
Operating junction and storage temperature	T_J, T_{Stg}		-55 to +175	°C

ELECTRICAL SPECIFICATIONS ($T_J = 25\text{ °C}$ unless otherwise specified)						
PARAMETER	SYMBOL	TEST CONDITIONS	MIN.	TYP.	MAX.	UNITS
Breakdown voltage, blocking voltage, per leg	V_{BR}, V_R	$I_R = 100\text{ }\mu\text{A}$	1200	-	-	V
Forward voltage, per leg	V_F	$I_F = 15\text{ A}$	-	2.5	3.3	
		$I_F = 15\text{ A}$, $T_J = 125\text{ °C}$	-	2.1	-	
Reverse leakage current, per leg	I_R	$V_R = V_R$ rated	-	-	50	μA
		$T_J = 125\text{ °C}$, $V_R = V_R$ rated	-	-	500	
Junction capacitance, per leg	C_T	$V_R = 200\text{ V}$	-	10	-	pF
Series inductance, per leg	L_S	Measured to lead 5 mm from package body	-	8	-	nH

DYNAMIC RECOVERY CHARACTERISTICS ($T_J = 25\text{ }^\circ\text{C}$ unless otherwise specified)						
PARAMETER	SYMBOL	TEST CONDITIONS	MIN.	TYP.	MAX.	UNITS
Reverse recovery time, per leg	t_{rr}	$I_F = 1.0\text{ A}$, $di_F/dt = 100\text{ A}/\mu\text{s}$, $V_R = 30\text{ V}$	-	29	44	ns
		$T_J = 25\text{ }^\circ\text{C}$	-	96	-	
		$T_J = 125\text{ }^\circ\text{C}$	-	137	-	
Peak recovery current, per leg	I_{RRM}	$T_J = 25\text{ }^\circ\text{C}$	-	11.5	-	A
		$T_J = 125\text{ }^\circ\text{C}$	-	16	-	
Reverse recovery charge, per leg	Q_{rr}	$T_J = 25\text{ }^\circ\text{C}$	-	375	-	nC
		$T_J = 125\text{ }^\circ\text{C}$	-	900	-	
Reverse recovery time, per leg	t_{rr}	$T_J = 25\text{ }^\circ\text{C}$	-	77.5	-	ns
		$T_J = 125\text{ }^\circ\text{C}$	-	106	-	
Peak recovery current, per leg	I_{RRM}	$T_J = 25\text{ }^\circ\text{C}$	-	21	-	A
		$T_J = 125\text{ }^\circ\text{C}$	-	29	-	
Reverse recovery charge, per leg	Q_{rr}	$T_J = 25\text{ }^\circ\text{C}$	-	680	-	nC
		$T_J = 125\text{ }^\circ\text{C}$	-	1600	-	

THERMAL - MECHANICAL SPECIFICATIONS						
PARAMETER	SYMBOL	TEST CONDITIONS	MIN.	TYP.	MAX.	UNITS
Thermal resistance, junction-to-case, per leg	R_{thJC}		-	-	1.4	$^\circ\text{C}/\text{W}$
Weight			-	6.0	-	g
Mounting torque			6.0 (5.0)	-	12 (10)	kgf · cm (lbf · in)
Maximum junction and storage temperature range	T_J , T_{Stg}		-55	-	175	$^\circ\text{C}$
Marking device		Case style TO-247AD 3L	C5PX3012L			

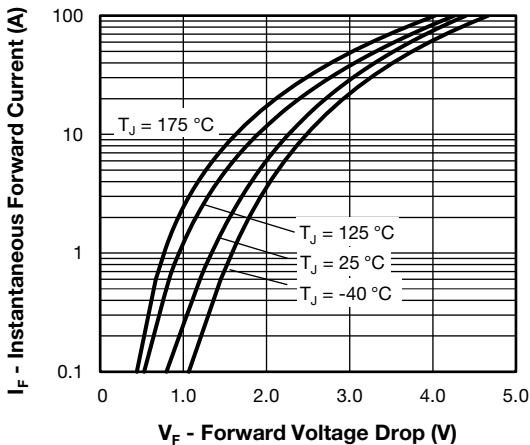

Fig. 1 - Forward Voltage Drop Characteristics, Per Leg

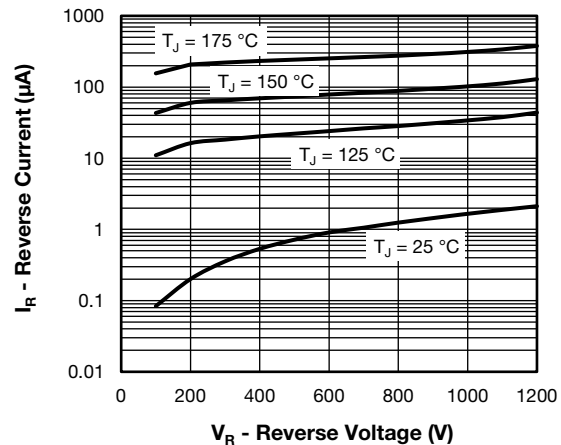

Fig. 2 - Typical Values of Reverse Current vs. Reverse Voltage, Per Leg

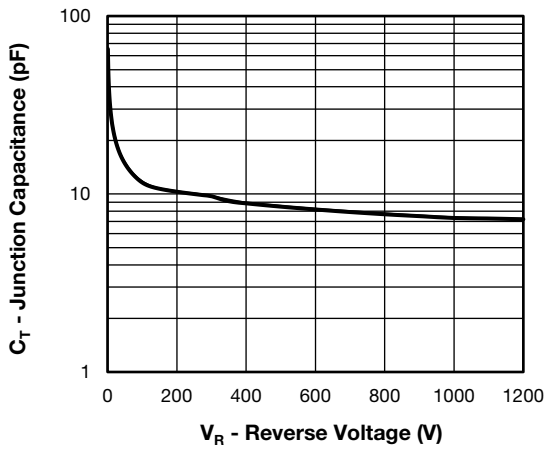

Fig. 3 - Typical Junction Capacitance vs. Reverse Voltage, Per Leg

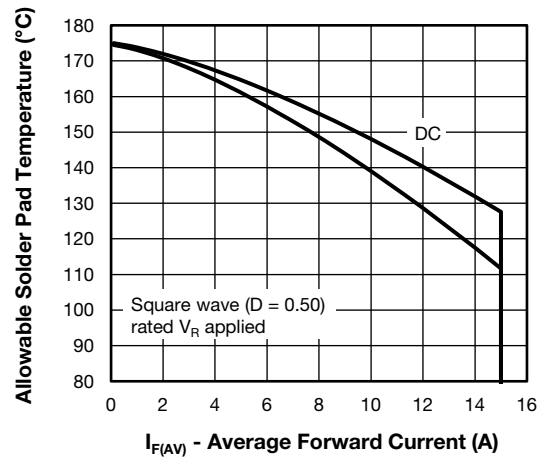

Fig. 4 - Maximum Allowable Case Temperature vs. Average Forward Current, Per Leg

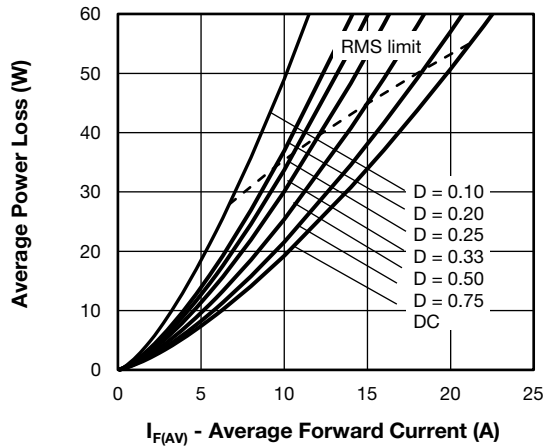

Fig. 5 - Forward Power Loss Characteristics, Per Leg

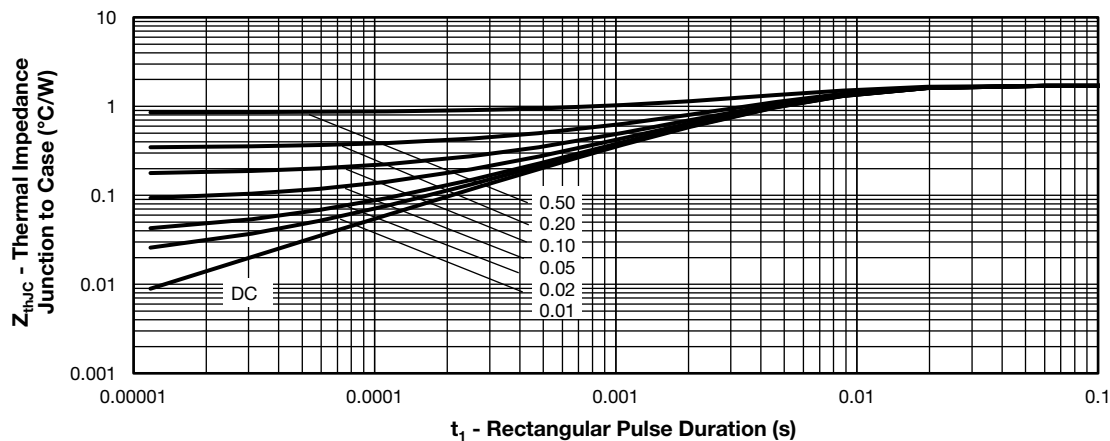

Fig. 6 - Transient Thermal Impedance, Junction to Case, Per Leg

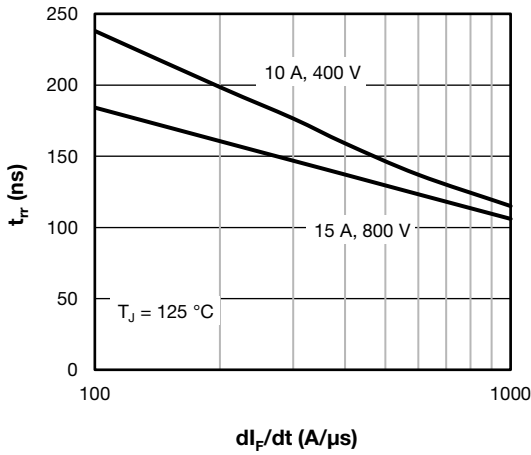

Fig. 7 - Typical Reverse Recovery Time vs. di_F/dt, Per Leg

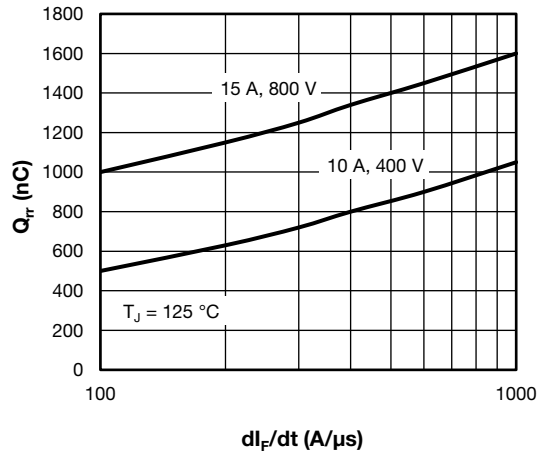

Fig. 8 - Typical Stored Charge vs. di_F/dt, Per Leg

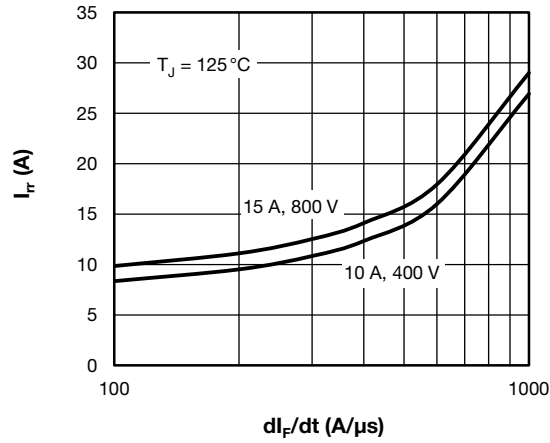

Fig. 9 - Typical Reverse Current vs. di_F/dt, Per Leg

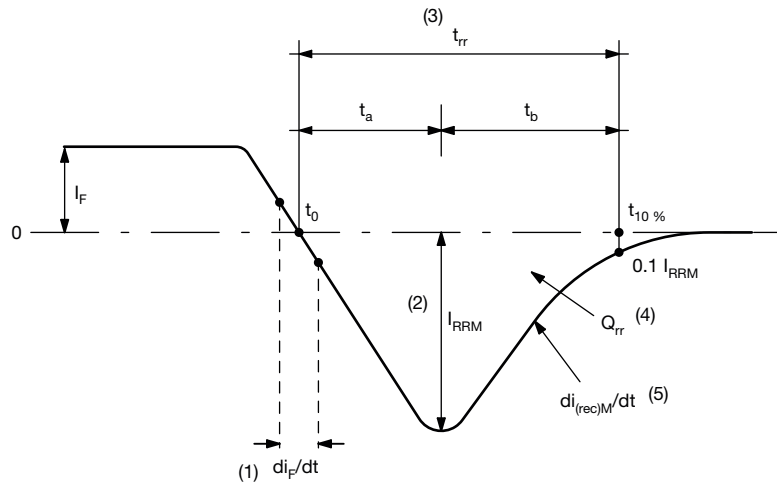

Fig. 10 - Reverse Recovery Waveform and Definitions

Notes

- (1) di_F/dt - rate of change of current through zero crossing
- (2) I_{RRM} - peak reverse recovery current
- (3) t_{rr} - reverse recovery time measured from t_0 , crossing point of negative going I_F , to point $t_{10\%}$, $0.1 I_{RRM}$
- (4) Q_{rr} - area under curve defined by t_0 and $t_{10\%}$

$$Q_{rr} = \int_{t_0}^{t_{10\%}} I(t) dt$$

- (5) $di_{(rec)M}/dt$ - peak rate of change of current during t_b portion of t_{rr}

ORDERING INFORMATION TABLE

Device code	VS-	C	5	P	X	30	12	L	-N3
	①	②	③	④	⑤	⑥	⑦	⑧	⑨

- | | |
|---|--|
| 1 | - Vishay Semiconductors product |
| 2 | - C = common cathode |
| 3 | - 5 = FRED generation 5 |
| 4 | - Package: P = TO-247AD 3L |
| 5 | - X = hyperfast recovery |
| 6 | - Current rating (30 = 30 A) |
| 7 | - Voltage rating (12 = 1200 V) |
| 8 | - L = long lead |
| 9 | - Environmental digit:
-N3 = halogen-free, RoHS-compliant, and totally lead (Pb)-free |

ORDERING INFORMATION (Example)			
PREFERRED P/N	QUANTITY PER TUBE	MINIMUM ORDER QUANTITY	PACKAGING DESCRIPTION
VS-CPX3012L-N3	25	500	Antistatic plastic tube

LINKS TO RELATED DOCUMENTS	
Dimensions	www.vishay.com/doc?95626
Part marking information	www.vishay.com/doc?95007

TO-247AD 3L

DIMENSIONS in millimeters and inches

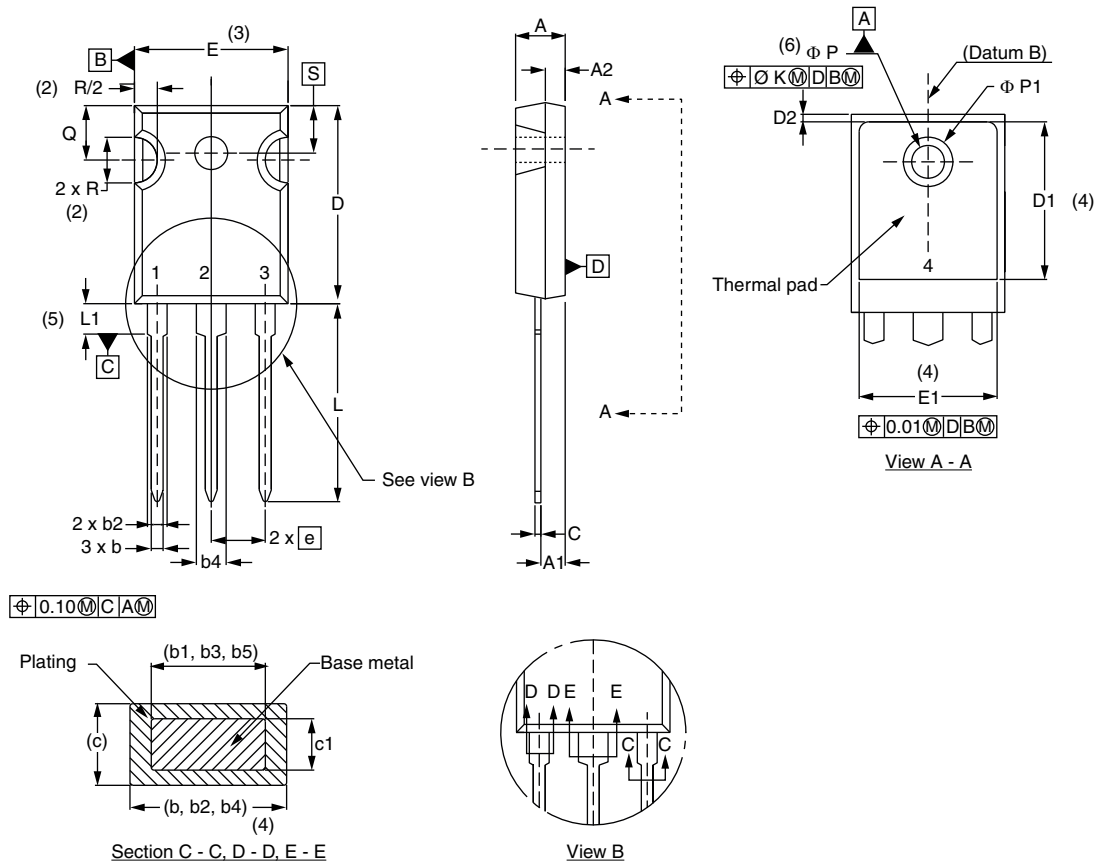

SYMBOL	MILLIMETERS		INCHES		NOTES	SYMBOL	MILLIMETERS		INCHES		NOTES
	MIN.	MAX.	MIN.	MAX.			MIN.	MAX.	MIN.	MAX.	
A	4.65	5.31	0.183	0.209		D2	0.51	1.30	0.020	0.051	
A1	2.21	2.59	0.087	0.102		E	15.29	15.87	0.602	0.625	3
A2	1.50	2.49	0.059	0.098		E1	13.46	-	0.53	-	
b	0.99	1.40	0.039	0.055		e	5.46 BSC		0.215 BSC		
b1	0.99	1.35	0.039	0.053		Ø K	0.254		0.010		
b2	1.65	2.39	0.065	0.094		L	19.81	20.32	0.780	0.800	
b3	1.65	2.34	0.065	0.092		L1	3.71	4.29	0.146	0.169	
b4	2.59	3.43	0.102	0.135		Ø P	3.56	3.66	0.14	0.144	
b5	2.59	3.38	0.102	0.133		Ø P1	-	6.98	-	0.275	
c	0.38	0.89	0.015	0.035		Q	5.31	5.69	0.209	0.224	
c1	0.38	0.84	0.015	0.033		R	4.52	5.49	0.178	0.216	
D	19.71	20.70	0.776	0.815	3	S	5.51 BSC		0.217 BSC		
D1	13.08	-	0.515	-	4						

Notes

- (1) Dimensioning and tolerancing per ASME Y14.5M-1994
- (2) Contour of slot optional
- (3) Dimension D and E do not include mold flash. These dimensions are measured at the outermost extremes of the plastic body
- (4) Thermal pad contour optional with dimensions D1 and E1
- (5) Lead finish uncontrolled in L1
- (6) Ø P to have a maximum draft angle of 1.5 to the top of the part with a maximum hole diameter of 3.91 mm (0.154")
- (7) Outline conforms to JEDEC® outline TO-247 with exception of dimension A min., D, E min., Q min., S, and note 4



Disclaimer

ALL PRODUCT, PRODUCT SPECIFICATIONS AND DATA ARE SUBJECT TO CHANGE WITHOUT NOTICE TO IMPROVE RELIABILITY, FUNCTION OR DESIGN OR OTHERWISE.

Vishay Intertechnology, Inc., its affiliates, agents, and employees, and all persons acting on its or their behalf (collectively, "Vishay"), disclaim any and all liability for any errors, inaccuracies or incompleteness contained in any datasheet or in any other disclosure relating to any product.

Vishay makes no warranty, representation or guarantee regarding the suitability of the products for any particular purpose or the continuing production of any product. To the maximum extent permitted by applicable law, Vishay disclaims (i) any and all liability arising out of the application or use of any product, (ii) any and all liability, including without limitation special, consequential or incidental damages, and (iii) any and all implied warranties, including warranties of fitness for particular purpose, non-infringement and merchantability.

Statements regarding the suitability of products for certain types of applications are based on Vishay's knowledge of typical requirements that are often placed on Vishay products in generic applications. Such statements are not binding statements about the suitability of products for a particular application. It is the customer's responsibility to validate that a particular product with the properties described in the product specification is suitable for use in a particular application. Parameters provided in datasheets and / or specifications may vary in different applications and performance may vary over time. All operating parameters, including typical parameters, must be validated for each customer application by the customer's technical experts. Product specifications do not expand or otherwise modify Vishay's terms and conditions of purchase, including but not limited to the warranty expressed therein.

Hyperlinks included in this datasheet may direct users to third-party websites. These links are provided as a convenience and for informational purposes only. Inclusion of these hyperlinks does not constitute an endorsement or an approval by Vishay of any of the products, services or opinions of the corporation, organization or individual associated with the third-party website. Vishay disclaims any and all liability and bears no responsibility for the accuracy, legality or content of the third-party website or for that of subsequent links.

Except as expressly indicated in writing, Vishay products are not designed for use in medical, life-saving, or life-sustaining applications or for any other application in which the failure of the Vishay product could result in personal injury or death. Customers using or selling Vishay products not expressly indicated for use in such applications do so at their own risk. Please contact authorized Vishay personnel to obtain written terms and conditions regarding products designed for such applications.

No license, express or implied, by estoppel or otherwise, to any intellectual property rights is granted by this document or by any conduct of Vishay. Product names and markings noted herein may be trademarks of their respective owners.