

TL1466I HIGH-SPEED/PRECISION SIX CHANNEL SWITCHING REGULATOR CONTROLLER

SLVS262 – FEBRUARY 2000

- High-Speed Output Circuit to Drive PNP Power Transistor
- Precision Reference Voltage . . . 1.5 V $\pm 2\%$ at $T_A = 25^\circ\text{C}$
- Oscillator Frequency . . . 50 kHz to 0.8 MHz
- Low Supply Voltage Operation $V_{CC} = 2.5\text{ V}$ to 12 V
- Output Voltage Limit (Channel 5 and 6)
- Low Supply Current
- Internal Undervoltage Lockout Protection
- Internal Short-Circuit Protection
- Shutdown Function
- External Sink Current Setting on Output Stage

description

The TL1466I is a six channel pulse-width-modulation (PWM) control circuit. This device contains reference voltage with a precision of $\pm 2\%$, a triangle wave oscillator capable of high frequency oscillation up to 0.8 MHz, various protection circuitry, and shutdown circuitry. The output regulation voltage for each channel is set by an external resistor divider. Moreover, the output stage is capable of driving a PNP power transistor with high speed. The high frequency/efficiency switching operation eliminates switching loss by using internal over-drive circuitry at the rising edge and with reverse bias connecting external bootstrap capacitor at the falling edge. The MOSFET can be used in parallel with the output diode at channel 1 and 4. This results in further high efficiency operation replacing the constant time with this MOSFET when the output diode is turned on. Furthermore, it operates 2.5 V supply voltage and balances switching current by switching repeatedly at the reverse phase with two pairs (channel 1, 4, 6, and 2, 3, 5) of the six channels. The oscillator output of channel 1, 4, and 6 is reverse phase for channel 2, 3, and 5. As a result of these features, this device is well-suited for power supply of portable systems in battery-powered equipment.

FUNCTION TABLE FOR STANDBY

INPUT		OUTPUT		
STANDBY	STANDBY-3	VREF	OUTPUT1, 2, 4, 5, 6	OUTPUT3
$V_I \leq 0.4\text{ V}$	X [†]	OFF	OFF	OFF
$V_I \geq 2\text{ V}$	$V_I \geq 2\text{ V}$	ON	ON	ON
	$V_I \leq 0.4\text{ V}$	ON	ON	OFF

[†] X: High-level or low-level



Please be aware that an important notice concerning availability, standard warranty, and use in critical applications of Texas Instruments semiconductor products and disclaimers thereto appears at the end of this data sheet.

PRODUCTION DATA information is current as of publication date. Products conform to specifications per the terms of Texas Instruments standard warranty. Production processing does not necessarily include testing of all parameters.



POST OFFICE BOX 655303 • DALLAS, TEXAS 75265

Copyright © 2000, Texas Instruments Incorporated

TL1466I

HIGH-SPEED/PRECISION SIX CHANNEL SWITCHING REGULATOR CONTROLLER

SLVS262 – FEBRUARY 2000

pin assignments

PM PACKAGE
(TOP VIEW)

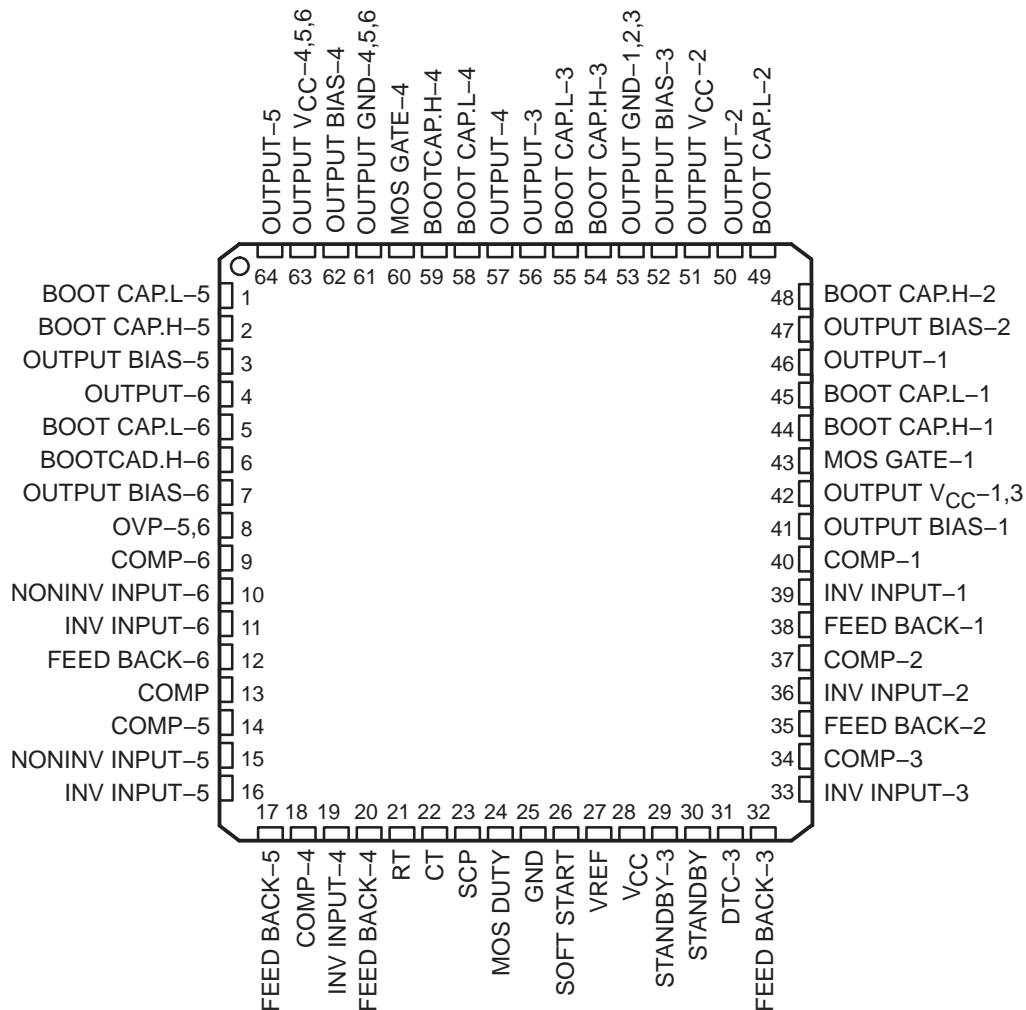

functional block diagram

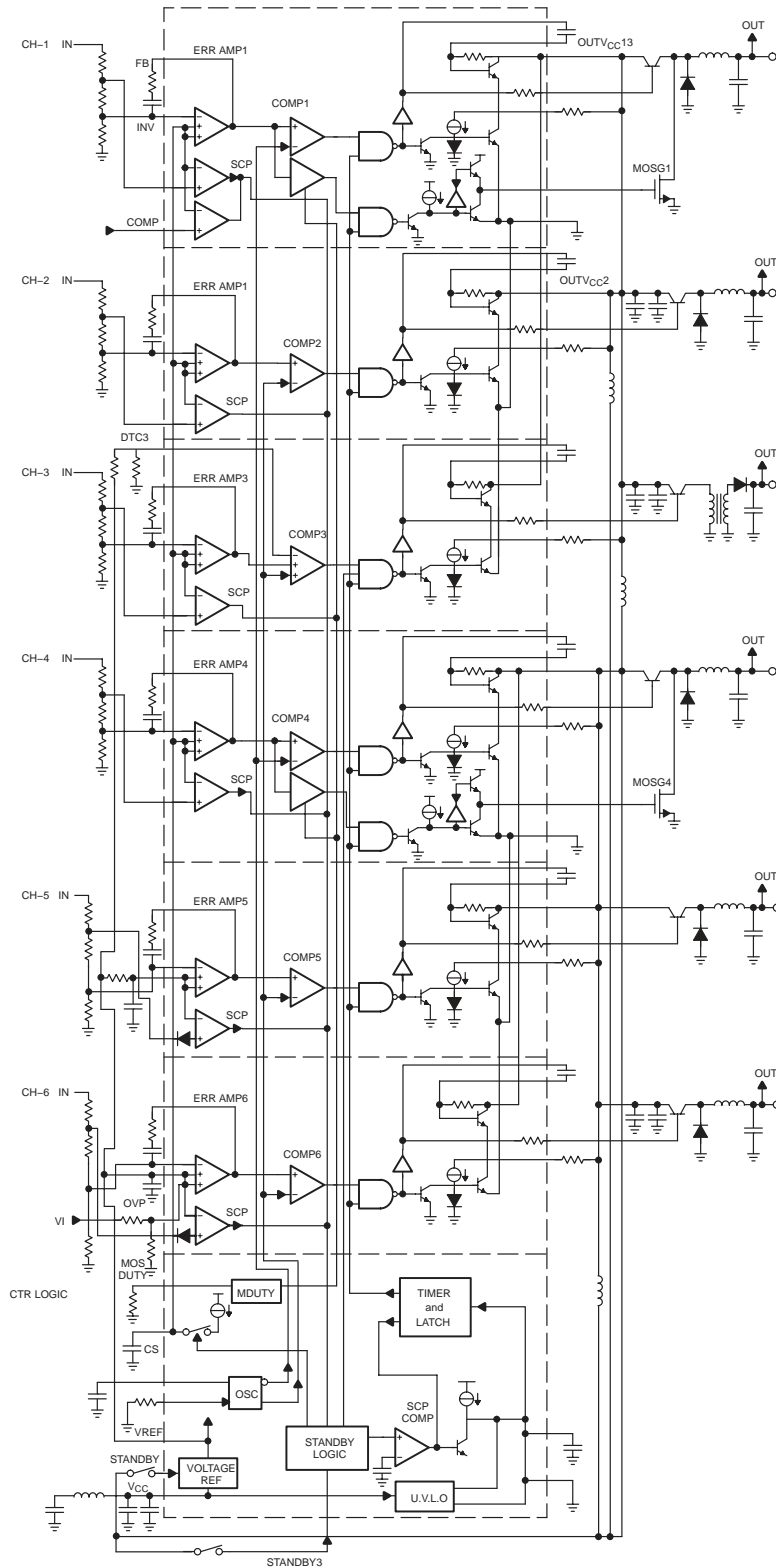

TL1466I HIGH-SPEED/PRECISION SIX CHANNEL SWITCHING REGULATOR CONTROLLER

SLVS262 – FEBRUARY 2000

Terminal Functions

TERMINAL NAME	NO.	DESCRIPTION
BOOT CAP.H-1	44	Bootstrap capacitor connection. The connection allows reverse-bias for external PNP transistor of channel 1.
BOOT CAP.L-1	45	
BOOT CAP.H-2	48	Bootstrap capacitor connection. The connection allows reverse-bias for external PNP transistor of channel 2.
BOOT CAP.L-2	49	
BOOT CAP.H-3	54	Bootstrap capacitor connection. The connection allows reverse-bias for external PNP transistor of channel 3.
BOOT CAP.L-3	55	
BOOT CAP.L-4	58	Bootstrap capacitor connection. The connection allows reverse-bias for external PNP transistor of channel 4.
BOOT CAP.H-4	59	
BOOT CAP.L-5	1	Bootstrap capacitor connection. The connection allows reverse-bias for external PNP transistor of channel 5.
BOOT CAP.H-5	2	
BOOT CAP.L-6	5	Bootstrap capacitor connection. The connection allows reverse-bias for external PNP transistor of channel 6.
BOOT CAP.H-6	6	
COMP	13	Output regulation voltage monitor terminal. When this terminal voltage drops below VREF voltage (1.5 V), charging to capacitor connected to SCP terminal (pin 23) is initiated.
COMP-1	40	Output regulation voltage monitor terminal (channel 1). When this terminal voltage drops below VREF voltage (1.5 V) charging to capacitor connected to SCP terminal (pin 23) is initiated.
COMP-2	37	Output regulation voltage monitor terminal (channel 2). When this terminal voltage drops below VREF voltage (1.5 V) charging to capacitor connected to SCP terminal (pin 23) is initiated.
COMP-3	34	Output regulation voltage monitor terminal (channel 3). When this terminal voltage drops below VREF voltage (1.5 V), charging to capacitor connected to SCP terminal (pin 23) is initiated.
COMP-4	18	Output regulation voltage monitor terminal (channel 4). When this terminal voltage drops below VREF voltage (1.5 V) charging to capacitor connected to SCP terminal (pin 23) is initiated.
COMP-5	14	Output regulation voltage monitor terminal (channel 5). When this terminal voltage drops below NONINV INPUT-5 terminal voltage - 0.55 V, charging to capacitor connected to SCP terminal (pin 23) is initiated.
COMP-6	9	Output regulation voltage monitor terminal (channel 6). When this terminal voltage drops below NONINV INPUT-6 terminal voltage - 0.55 V, charging to capacitor connected to SCP terminal (pin 23) is initiated.
CT	22	Timing capacitor connection for oscillation frequency setting.
DTC-3	31	Dead-time control input for channel 3. The maximum ON duty cycle for OUTPUT-3 terminal is determined by comparing the input voltage of this terminal with the oscillator output (triangle wave).
FEEDBACK-1	38	Error amplifier output terminal (channel 1)
FEEDBACK-2	35	Error amplifier output terminal (channel 2)
FEEDBACK-3	32	Error amplifier output terminal (channel 3)
FEEDBACK-4	20	Error amplifier output terminal (channel 4)
FEEDBACK-5	17	Error amplifier output terminal (channel 5)
FEEDBACK-6	12	Error amplifier output terminal (channel 6)
GND	25	Logic ground
INV INPUT-1	39	Error amplifier inverting input terminal (channel 1)
INV INPUT-2	36	Error amplifier inverting input terminal (channel 2)
INV INPUT-3	33	Error amplifier inverting input terminal (channel 3)
INV INPUT-4	19	Error amplifier inverting input terminal (channel 4)
INV INPUT-5	16	Error amplifier inverting input terminal (channel 5)
INV INPUT-6	11	Error amplifier inverting input terminal (channel 6)
MOS DUTY	24	N-channel MOSFET ON duty cycle setting for the synchronous rectification of channel 1 and 4. The MOSFET ON duty cycle for the synchronous rectification is determined by the resistor value connected between this terminal and GND.



TL1466I
HIGH-SPEED/PRECISION SIX CHANNEL
SWITCHING REGULATOR CONTROLLER

SLVS262 – FEBRUARY 2000

Terminal Functions (Continued)

TERMINAL NAME	NO.	DESCRIPTION
MOS GATE–1	43	N-Channel MOSFET gate drive for the synchronous rectification of channel 1. The ON duty cycle for this terminal is determined by the resistor value connected to MOS DUTY (pin 24).
MOS GATE–4	60	N-Channel MOSFET gate drive for the synchronous rectification of channel 4. The ON duty cycle for this terminal is determined by the resistor value connected to MOS DUTY (pin 24).
NONINV INPUT–5	15	Error amplifier noninverting input terminal (channel 6). By connecting resistor and capacitor to this terminal, soft start function is accomplished increasing this terminal voltage slowly.
NONINV INPUT–6	10	Error amplifier noninverting input terminal (channel 6). By connecting resistor and capacitor to this terminal, soft start function is accomplished increasing this terminal voltage slowly.
OUTPUT–1	46	Output terminal to drive base for external PNP transistor of channel 1.
OUTPUT–2	50	Output terminal to drive base for external PNP transistor of channel 2.
OUTPUT–3	56	Output terminal to drive base for external PNP transistor of channel 3.
OUTPUT–4	57	Output terminal to drive base for external PNP transistor of channel 4.
OUTPUT–5	64	Output terminal to drive base for external PNP transistor of channel 5.
OUTPUT–6	4	Output terminal to drive base for external PNP transistor of channel 6.
OUTPUT BIAS–1	41	Resistor connection to set output sink current for OUTPUT–1 terminal (pin 46) of channel 1.
OUTPUT BIAS–2	47	Resistor connection to set output sink current for OUTPUT–2 terminal (pin 50) of channel 2.
OUTPUT BIAS–3	52	Resistor connection to set output sink current for OUTPUT–3 terminal (pin 56) of channel 3.
OUTPUT BIAS–4	62	Resistor connection to set output sink current for OUTPUT–4 terminal (pin 57) of channel 4.
OUTPUT BIAS–5	3	Resistor connection to set output sink current for OUTPUT–5 terminal (pin 64) of channel 5.
OUTPUT BIAS–6	7	Resistor connection to set output sink current for OUTPUT–6 terminal (pin 4) of channel 6.
OUTPUT GND–1,2,3	53	Ground for channel 1, 2, and 3 output.
OUTPUT GND–4,5,6	61	Ground for channel 4, 5, and 6 output.
OUTPUT V _{CC} –1,3	42	Supply voltage for channel 1 and 3 outputs.
OUTPUT V _{CC} –2	51	Supply voltage for channel 2 output.
OUTPUT V _{CC} –4,5,6	63	Supply voltage for channel 4, 5, and 6 outputs.
OVP–5,6	8	Over-voltage threshold voltage setting for output regulation voltage of channel 5 and 6.
RT	21	Timing resistor connection for oscillation frequency setting.
SCP	23	Capacitor connection for short-circuit protection. When voltage across COMP terminal for each channel is dropped below the specified threshold voltage, the capacitor connected between SCP and GND is charged by the constant current source (2.5 μ A Typ). If the voltage reaches to 1.5 V, the timer latch circuitry is set and all channel outputs are forced to turn off.
SOFT START	26	Soft start operation for channel 1 to 4. By connecting a capacitor between this terminal connected internally to error amplifier noninverting input for channel 1 to 4 and GND, soft start operation is enabled charging a capacitor with the constant current source (3 μ A Typ). Moreover, the same soft start operation is also enabled at the standby release using STANDBY–3 terminal only for channel 3.
STANDBY	30	ON/OFF common control input for all channels. The all channels output is turned off by adding low-level input voltage (0.4 V Max) to this terminal, and the reference voltage is also shutdown.
STANDBY–3	29	ON/OFF control input for channel 3. The channel 3 output is turned off by adding low-level input voltage (0.4 V Max) to this terminal.
V _{CC}	28	Supply voltage
VREF	27	1.5 V reference voltage output

TL1466I

HIGH-SPEED/PRECISION SIX CHANNEL SWITCHING REGULATOR CONTROLLER

SLVS262 – FEBRUARY 2000

absolute maximum ratings over operating free-air temperature (unless otherwise noted)†

Supply voltage, V_{CC} (see Note 1)	13 V
Input voltage, V_I at OVP, COMP	13 V
Error amplifier input voltage, $V_{(AMP)}$	13 V
Output voltage, V_O	13 V
Peak output sink current, $I_{(SINK)}$	100 mA
Peak output source current, $I_{(SOURCE)}$	-0.5 A
Continuous power total dissipation at (or below) 25°C free-air temperature (see Note 2)	1785 mW
Operating free-air temperature range, T_A	-20°C to 75°C
Storage temperature range, T_{stg}	-65°C to 150°C
Lead temperature 1,6 mm (1/16 inch) from case for 10 seconds	260°C

† Stresses beyond those listed under “absolute maximum ratings” may cause permanent damage to the device. These are stress ratings only, and functional operation of the device at these or any other conditions beyond those indicated under “recommended operating conditions” is not implied. Exposure to absolute-maximum-rated conditions for extended periods may affect device reliability.

- NOTES: 1. All voltages are with respect to GND.
2. Device mounted on a 50 mm × 1.6 mm, fFR4 printed-circuit board.

recommended operating conditions

	MIN	NOM	MAX	UNIT
Supply voltage, V_{CC}	2.5		12	V
High-level standby input voltage (pin 29, 30), $V_{I(HS)}$	2	V_{CC}		V
Low-level standby input voltage (pin 29, 30), $V_{I(LS)}$			0.4	V
Output voltage, V_O			12	V
Current into feedback terminal, I_{OAMP}	Channel 1, 4		-30	μA
	Channel 2, 3, 5, 6		-45	
Feedback capacitance, $C_{(NF)}$	0.5	5	100	nF
Bootstrap capacitance, $C_{(BOOT)}$	100	500		pF
Bias resistor, $R_{(BIAS)}$	3		20	k Ω
Timing resistor, $R_{(T)}$	12		100	k Ω
Timing capacitor, $C_{(T)}$	68		1000	pF
Oscillator frequency, $f_{(osc)}$	0.05		0.8	MHz
Operating free-air temperature, T_A	-20		75	°C

electrical characteristics over recommended operating free-air temperature range, $V_{CC} = 6 V$, $f = 0.43 MHz$ (unless otherwise noted)

reference section

PARAMETER	TEST CONDITIONS	MIN	TYP	MAX	UNIT
V_{ref} Output voltage (pin 27)	$T_A = 25^\circ C$, $I_{OR} = -1 mA$	1.47	1.50	1.53	V
$R_{(EGIN)}$ Line regulation	$V_{CC} = 2.5 V$ to 12 V, $I_{OR} = -1 mA$		2	12.5	mV
$R_{(EGL)}$ Load regulation	$I_{OL} = -0.1 mA$ to -1 mA		1	7.5	mV
$V_{(RTC1)}$ $V_{(RTC2)}$ Output voltage change with temperature	$T_A = -20^\circ C$ to 25°C		-0.2%	±2%	
	$T_A = 25^\circ C$ to 75°C		-0.2%	±2%	
I_{OS} Short-circuit output current	$V_{ref} = 0 V$	-4	-20		mA



TL1466I HIGH-SPEED/PRECISION SIX CHANNEL SWITCHING REGULATOR CONTROLLER

SLVS262 – FEBRUARY 2000

electrical characteristics over recommended operating free-air temperature range, $V_{CC} = 6\text{ V}$, $f = 0.43\text{ MHz}$ (unless otherwise noted) (continued)

undervoltage lockout section

PARAMETER		TEST CONDITIONS	MIN	TYP	MAX	UNIT
$V_{(th)}$	High-level threshold voltage	$T_A = 25^\circ\text{C}$		2.45		V
$V_{(tl)}$	Low-level threshold voltage			2.35		V
V_{hys}	Hysteresis		0.05	0.1		V
$V_{(R)}$	Reset threshold voltage (V_{CC})		2.1	2.2		V

oscillator section

PARAMETER		TEST CONDITIONS	MIN	TYP	MAX	UNIT
$f_{(OSC)}$	Oscillator frequency	$C_{(T)} = 100\text{ pF}$, $R_{(T)} = 47\text{ k}\Omega$		0.43		MHz
$f_{(dev)}$	Standard deviation of frequency	All the values are constant		7%		
$f_{(dv)}$	Frequency change with voltage	$V_{CC} = 2.5\text{ V to }12\text{ V}$		1%		
$f_{(dT1)}$	Frequency change with temperature	$T_A = -20^\circ\text{C to }25^\circ\text{C}$		-0.5%	$\pm 4\%$	
$f_{(dT2)}$		$T_A = 20^\circ\text{C to }75^\circ\text{C}$		0.5%	$\pm 4\%$	

output voltage monitor section

PARAMETER		TEST CONDITIONS	MIN	TYP	MAX	UNIT
$V_{(tOM)}$	Input threshold voltage (COMP terminals: pin 13, 18, 34, 37, 40)	$T_A = 25^\circ\text{C}$ (channel 1, 2, 3, 4)	1.45	1.50	1.55	V
$V_{(IOOM)}$	Input offset voltage (pin 9, 14)	$V_I(10, 15\text{ pin}) = 1.5\text{ V}$, $T_A = 25^\circ\text{C}$ (channel 5,6)		0.55		V
$I_{(ICOMP)}$	Input bias current	Pin 13, 18, 34, 37, 40		-0.8	-2	μA
		Pin 9, 14	$V_I = 0.5\text{ V}$, $V_I(10, 15\text{ pin}) = 1.5\text{ V}$			

short-circuit protection control section

PARAMETER		TEST CONDITIONS	MIN	TYP	MAX	UNIT
$V_{(tPC)}$	Input threshold voltage (pin 23)	$T_A = 25^\circ\text{C}$	1.45	1.53	1.61	V
$V_{(STBY)}$	UVLO standby voltage (pin 23)		20	60	100	mV
V_I	Latched input voltage (pin 23)			10	30	mV
$I_{(bPC)}$	Input source current (pin 23)	$T_A = 25^\circ\text{C}$	-1	-2.5	-3.5	μA

dead-time control section (channel 3)

PARAMETER		TEST CONDITIONS	MIN	TYP	MAX	UNIT
$I_{(Idt)}$	Input current (DTC-3 terminal: pin 31)	$V_I(31\text{ pin}) = 0.5\text{ V}$		-1	-6	μA
$V_{(t)}$	Input threshold voltage	Duty cycle = 0%	0.55	0.65	0.75	V
$V_{(t100)}$		Duty cycle = 100%	1.25	1.35	1.45	



TL1466I

HIGH-SPEED/PRECISION SIX CHANNEL SWITCHING REGULATOR CONTROLLER

SLVS262 – FEBRUARY 2000

electrical characteristics over recommended operating free-air temperature range, $V_{CC} = 6\text{ V}$, $f = 0.43\text{ MHz}$ (unless otherwise noted) (continued)

error-amplifier section

PARAMETER	TEST CONDITIONS	MIN	TYP	MAX	UNIT	
$V_{(t)}$ Input threshold voltage	$V_O = 1\text{ V}$ (channel 1, 2, 3, 4)	1.46	1.50	1.54	V	
V_{IO} Input offset current	$V_O = 1\text{ V}$ (channel 5, 6)		5	40	mV	
I_{IB} Input bias current	$V_O = 1\text{ V}$	INV INPUT (pin 11, 16, 19, 33, 36, 39)		-200	-500	nA
		INV INPUT (pin 10, 15)		-0.9	-2.5	μA
V_{ICR} Common-mode input voltage range	$V_{CC} = 2.5\text{ V}$ to 12 V		0 to $V_{CC}-1$		V	
$A_{(v)}$ Open-loop voltage amplification			70		dB	
B1 Unity-gain bandwidth			6		MHz	
V_{OM+} Positive output voltage swing			$V_{ref}-0.1$		V	
V_{OM-} Negative output voltage swing				0.2	V	
I_{OM+} Output sink current	$V_O = 1\text{ V}$	0.5	2		mA	
I_{OM-} Output source current	$V_O = 1\text{ V}$	Channel 1, 4		-30	-80	μA
		Channel 2, 3, 5, 6		-45	-100	

output voltage limit section (channel 5, 6)

PARAMETER	TEST CONDITIONS	MIN	TYP	MAX	UNIT
$V_{(tOV)}$ Input threshold voltage	$V_{I(10, 15\text{ pin})} = 1\text{ V}$	0.95	1	1.05	V
$V_{(BOV)}$ Input bias current	$V_{I(8\text{ pin})} = 1.5\text{ V}$, $V_{I(10, 15\text{ pin})} = 1\text{ V}$		-0.7	-2	μA

soft start section

PARAMETER	TEST CONDITIONS	MIN	TYP	MAX	UNIT
$I_{(bss)}$ Input source current (pin 26)	STANDBY-3 terminal = 2 V SOFT START terminal = 1 V	-1	-2.5	-4	μA

MOSFET DUTY setting section (channel 1, 4)

PARAMETER	TEST CONDITIONS	MIN	TYP	MAX	UNIT
$D_{(MOS)}$ ON DUTY	$V_{(FB)} = 1\text{ V}$	$R_{DUTY} = 5\text{ k}\Omega$		20%	
		$R_{DUTY} = 25\text{ k}\Omega$		40%	

output section

PARAMETER	TEST CONDITIONS	MIN	TYP	MAX	UNIT
$I_{(SINK)}$ Output sink current	$R_{(BIAS)} = 6.8\text{ k}\Omega$	6.3	8.5	10.7	mA
	$R_{(BIAS)} = 10\text{ k}\Omega$	4.5	6	7.5	
$I_{(GSOURCE)}$ MOS gate source current	$V_O(43, 60\text{ pin}) = 1\text{ V}$, $T_A = 25^\circ\text{C}$		-50		mA
$I_{(GSINK)}$ MOS gate sink current	$V_O(43, 60\text{ pin}) = 2\text{ V}$, $T_A = 25^\circ\text{C}$		50		mA
$I_{(GOH)}$ MOS gate high-level output voltage		3.5	4		V
$I_{(GOL)}$ MOS gate low-level output voltage			0.1	0.3	

total device

PARAMETER	TEST CONDITIONS	MIN	TYP	MAX	UNIT
$I_{(ccs)}$ Standby supply current	STANDBY terminal = 0 V		1	10	μA
$I_{(cca)}$ Average supply current	$R_{(T)} = 47\text{ k}\Omega$		6	9	mA



PARAMETER MEASUREMENT INFORMATION

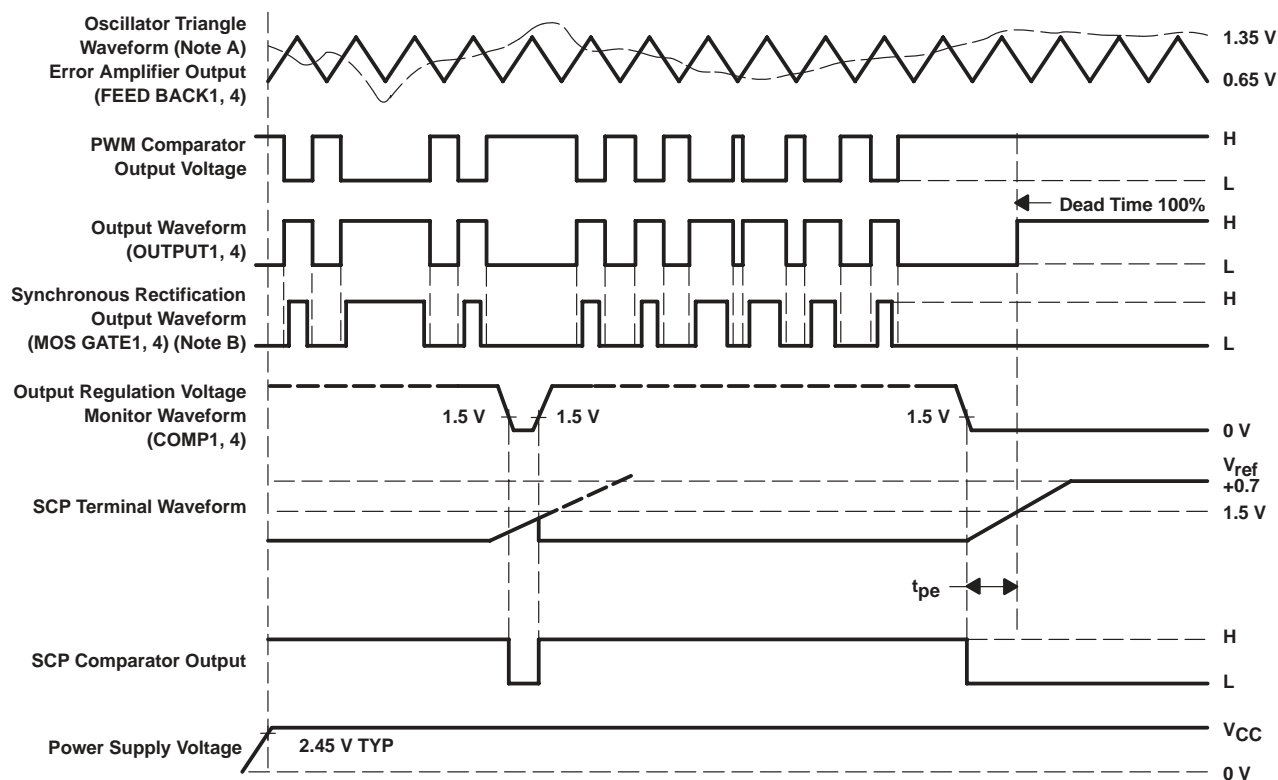

† Protection enable time, $t_{pe} = (588 \times 10^3 \times C_{pe})$ in seconds

NOTES: A. The oscillator output of channel 1, 4, and 6 is reverse phase for channel 2, 3, and 5.

B. The ON (high-level output state) time for the synchronous rectification output (MOS GATE1, 4) is determined by the resistor value connected to MOS DUTY terminal (pin 24) and this time is controlled internally without exceeding OFF (high-level output state) of output (OUTPUT1,4).

Figure 1. Timing Diagram (channel 1, 4)

TL1466I
HIGH-SPEED/PRECISION SIX CHANNEL
SWITCHING REGULATOR CONTROLLER

SLVS262 – FEBRUARY 2000

PARAMETER MEASUREMENT INFORMATION

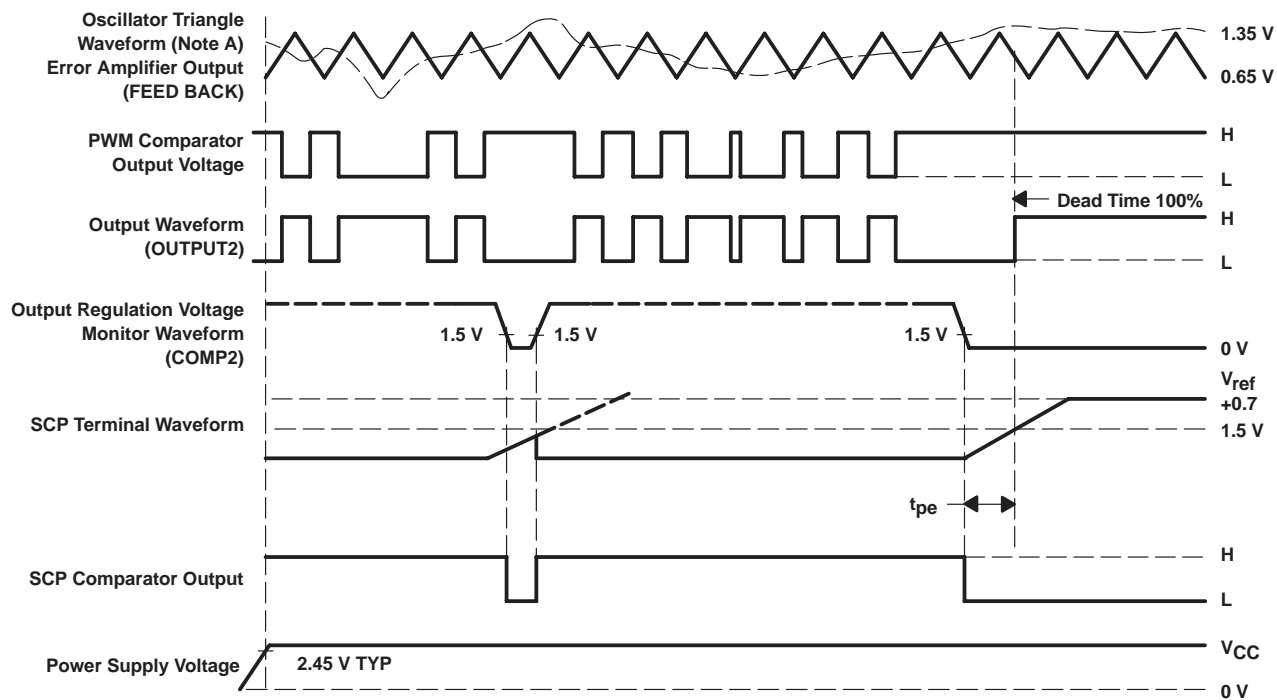

† Protection enable time, $t_{pe} = (588 \times 10^3 \times C_{pe})$ in seconds

NOTE A: The oscillator output of channel 1, 4, and 6 is reverse phase for channel 2, 3, and 5.

Figure 2. Timing Diagram (channel 2)

PARAMETER MEASUREMENT INFORMATION

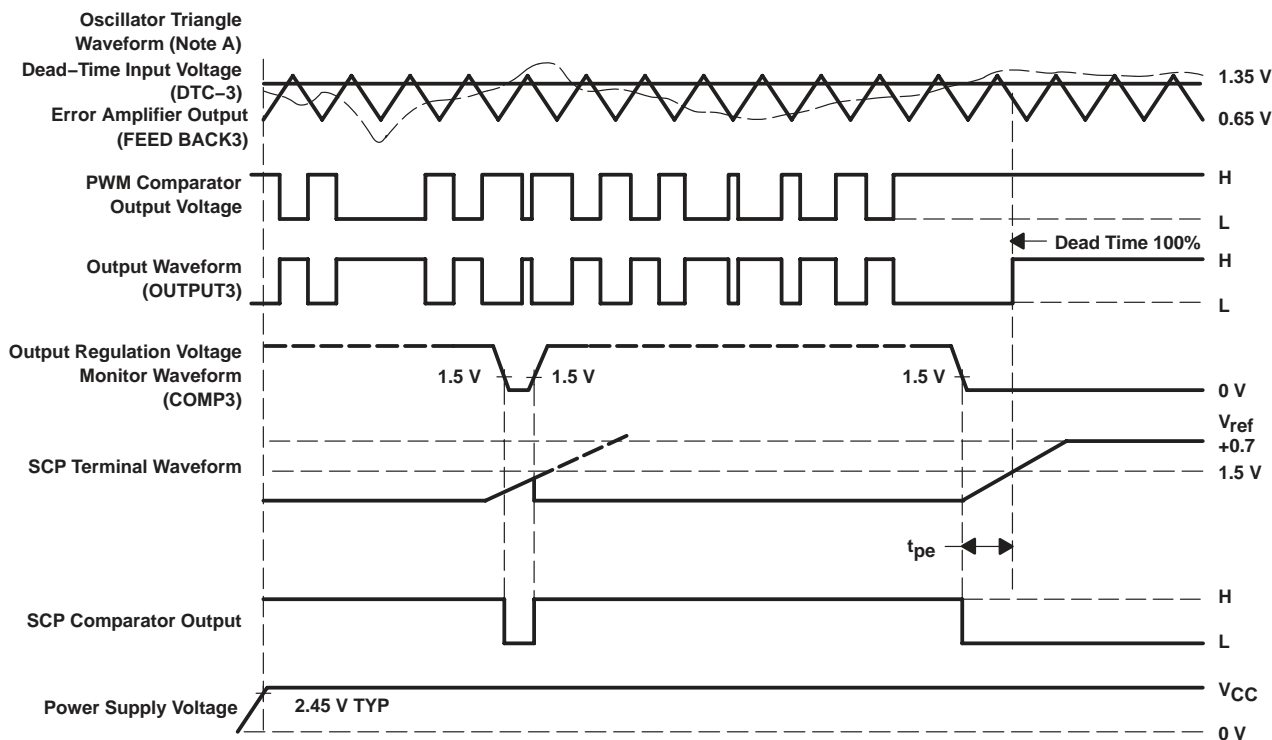

† Protection enable time, $t_{pe} = (588 \times 10^3 \times C_{pe})$ in seconds

NOTE A: The oscillator output of channel 1, 4, and 6 is reverse phase for channel 2, 3, and 5.

Figure 3. Timing Diagram (channel 3)

TL1466I
HIGH-SPEED/PRECISION SIX CHANNEL
SWITCHING REGULATOR CONTROLLER

SLVS262 – FEBRUARY 2000

PARAMETER MEASUREMENT INFORMATION

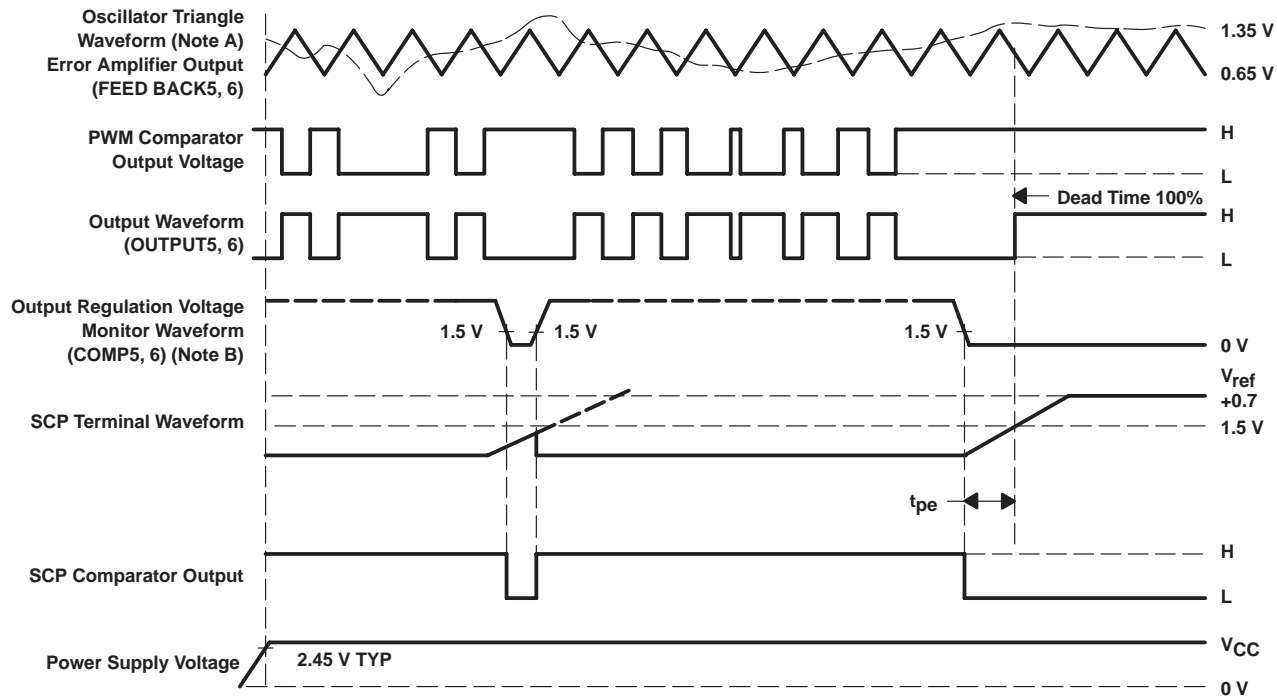

† Protection enable time, $t_{pe} = (588 \times 10^3 \times C_{pe})$ in seconds

NOTES: A. The oscillator output of channel 1, 4, and 6 is reverse phase for channel 2, 3, and 5.

B. The threshold voltage at $V_{(A)}$ is set by following the formula below:

$V_{(A)}$ Input voltage of NONINV INPUT terminal (pin 10, 15) -0.55 V

Figure 4. Timing Diagram (channel 5, 6)

TYPICAL CHARACTERISTICS

OSCILLATOR FREQUENCY
 vs
 TIMING RESISTANCE

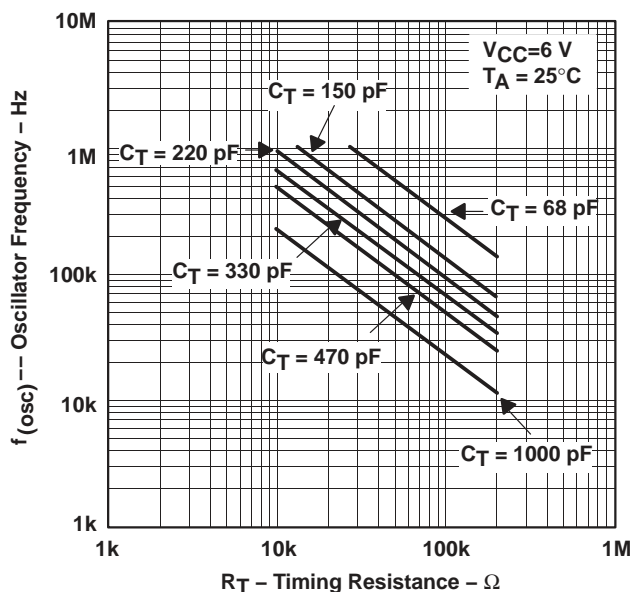

Figure 5

OSCILLATOR FREQUENCY
 vs
 FREE-AIR TEMPERATURE

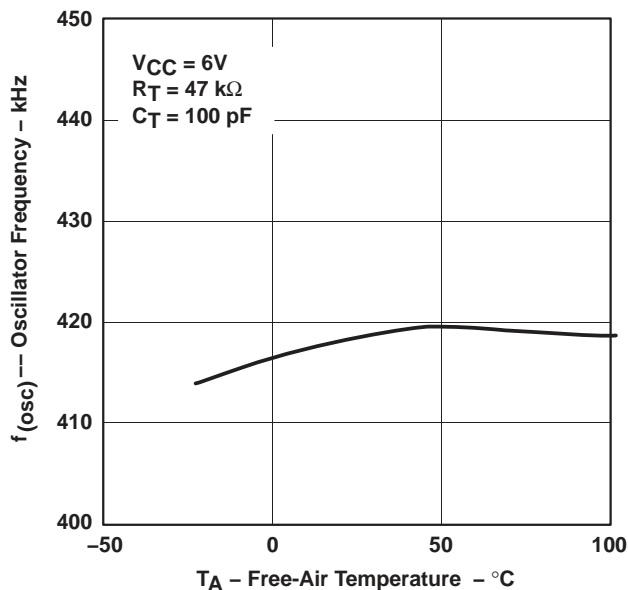

Figure 6

AVERAGE SUPPLY CURRENT
 vs
 FREE-AIR TEMPERATURE

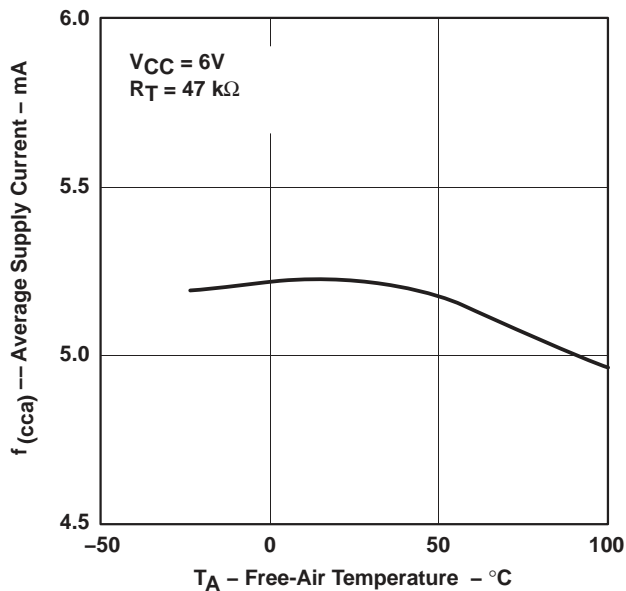

Figure 7

AVERAGE SUPPLY CURRENT
 vs
 SUPPLY VOLTAGE

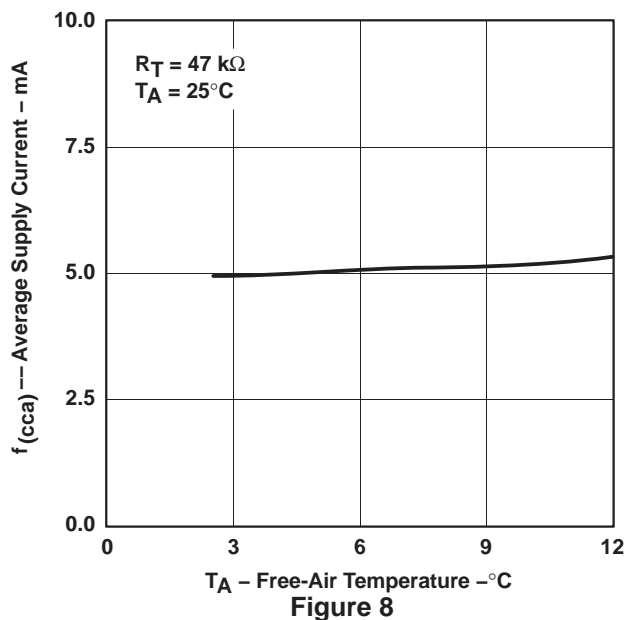
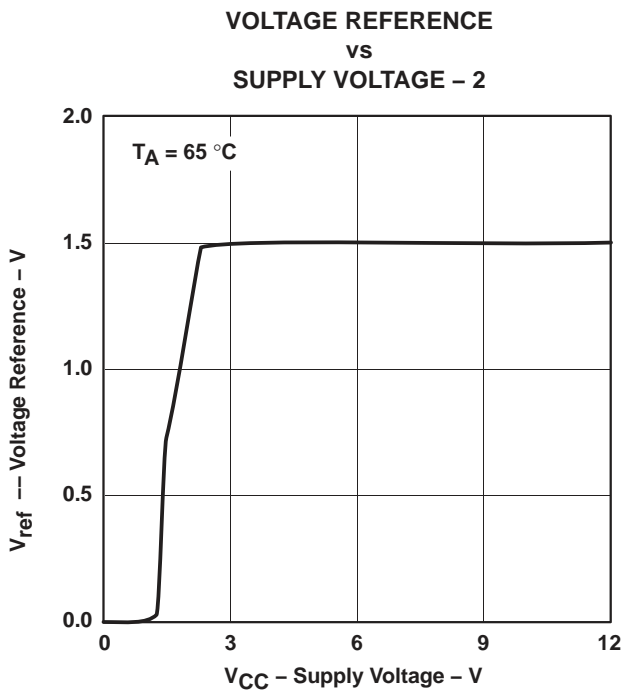
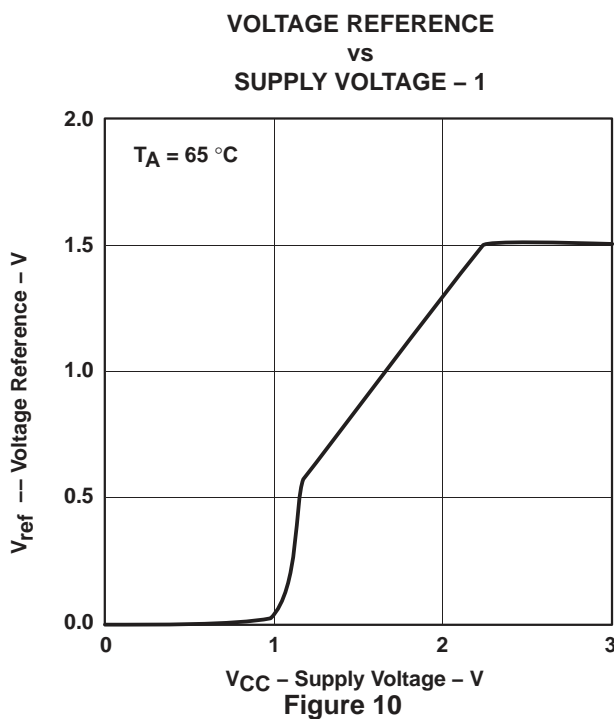
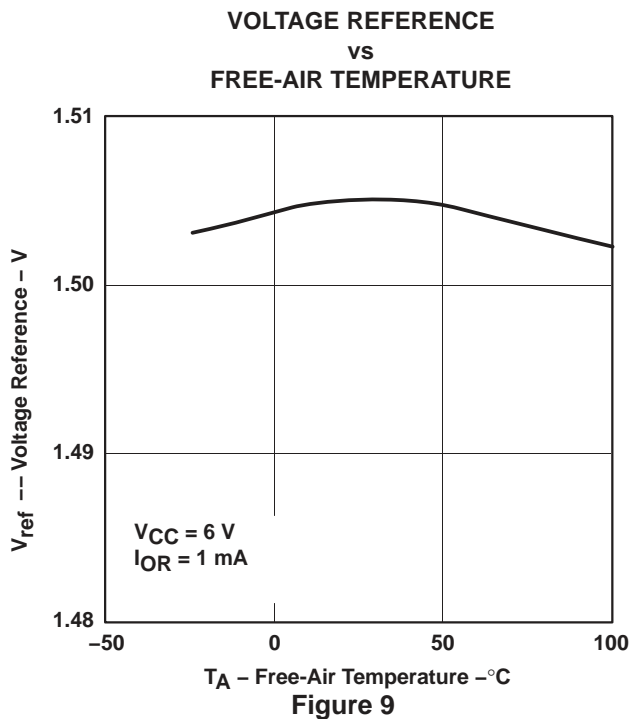
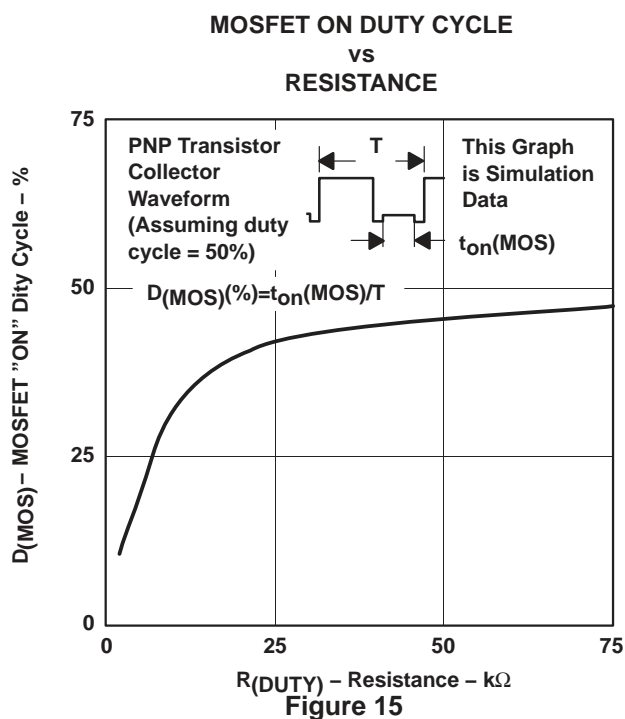
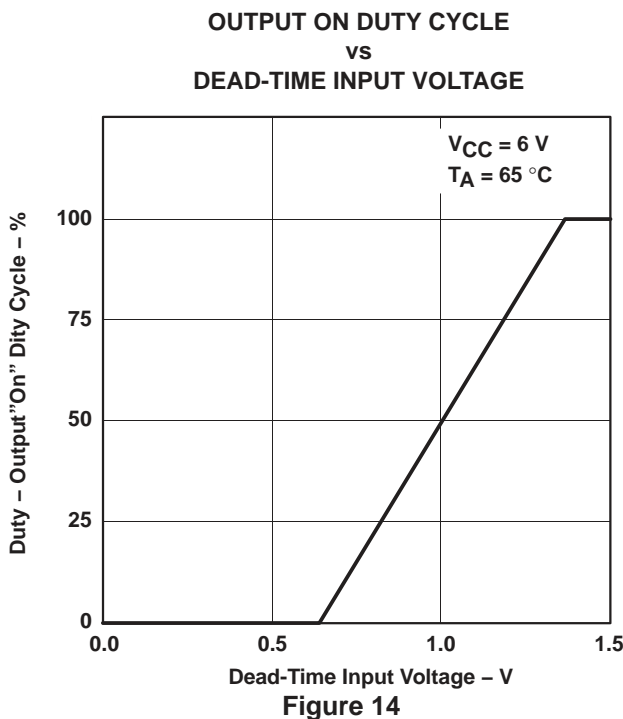
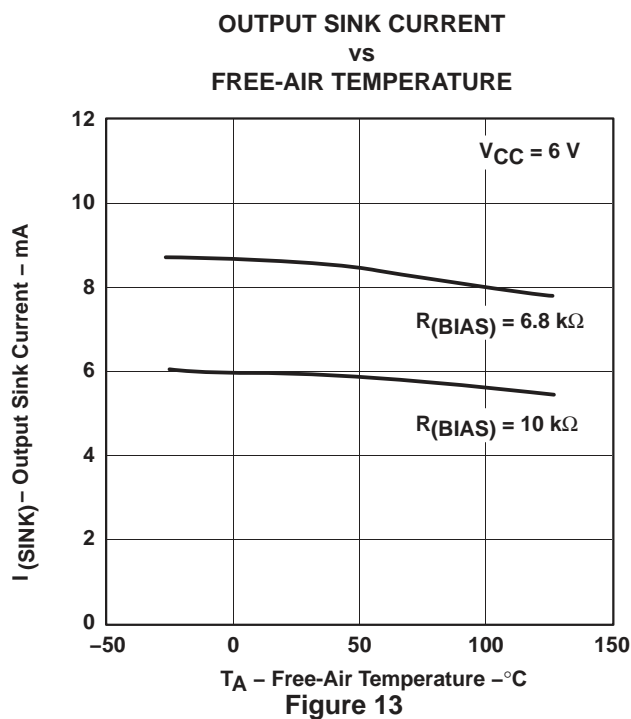
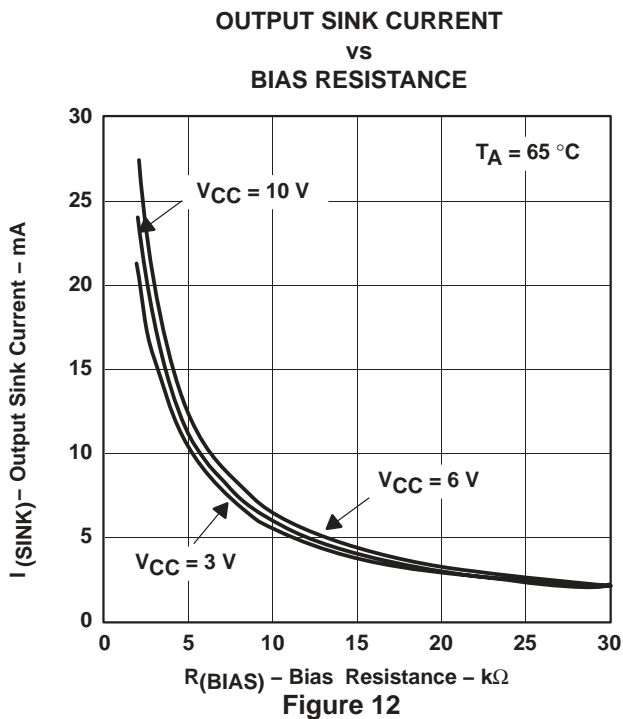

Figure 8

TYPICAL CHARACTERISTICS



TYPICAL CHARACTERISTICS



TYPICAL CHARACTERISTICS

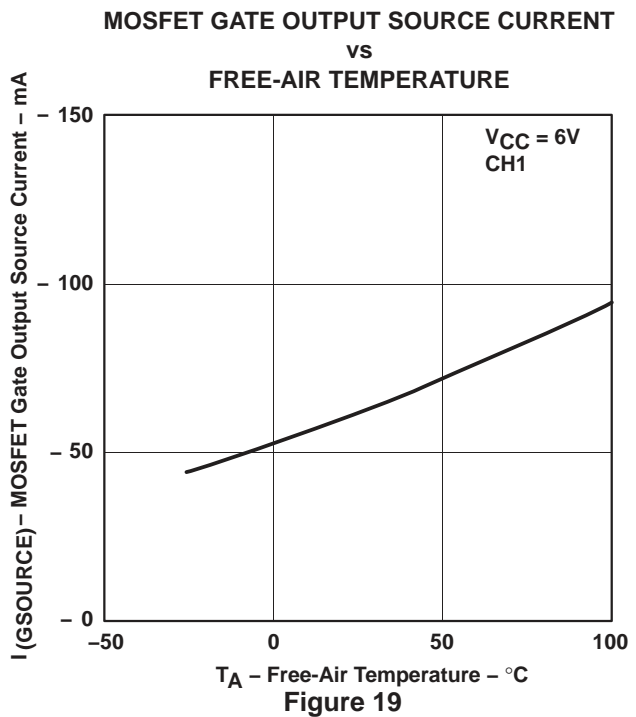
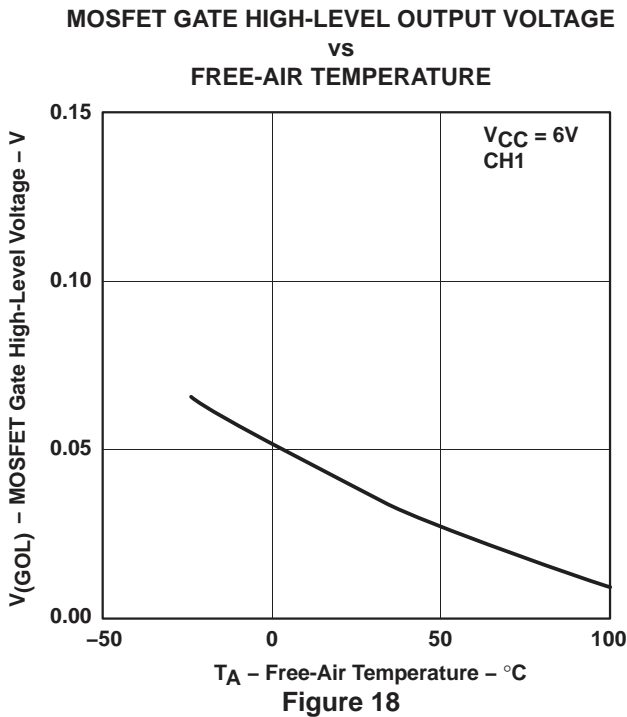
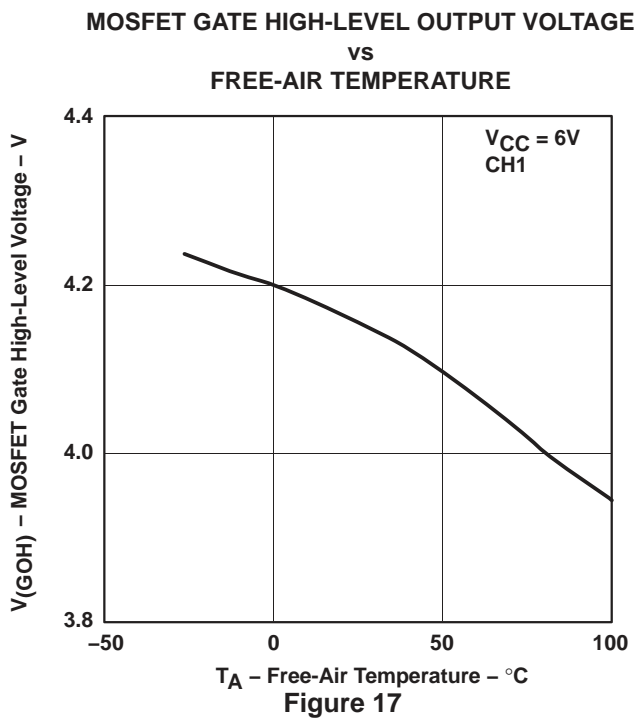
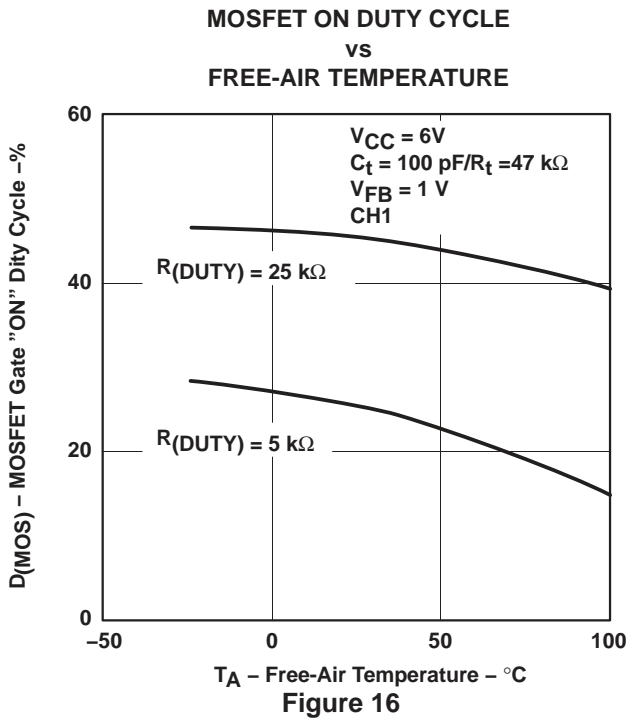

TYPICAL CHARACTERISTICS

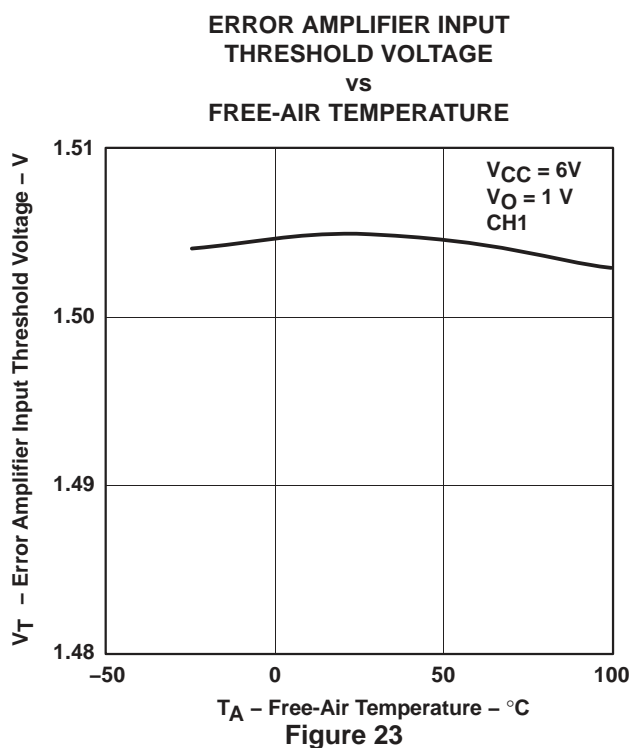
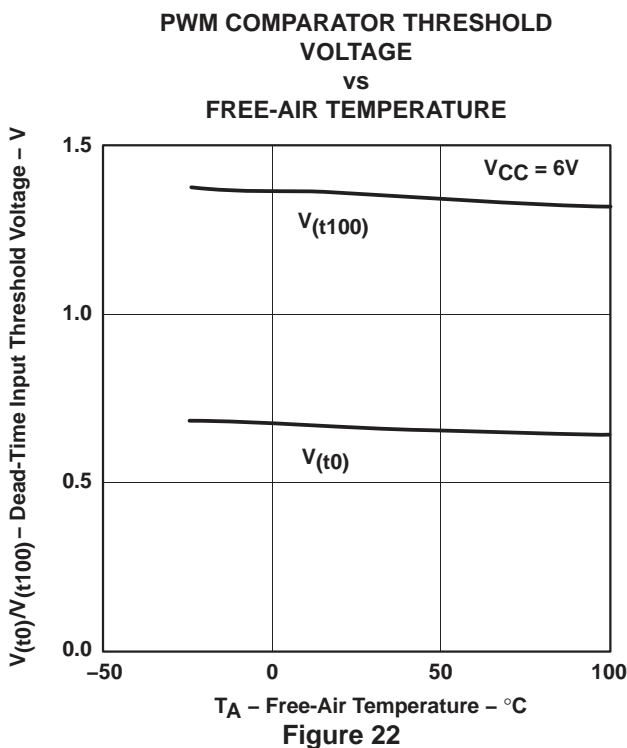
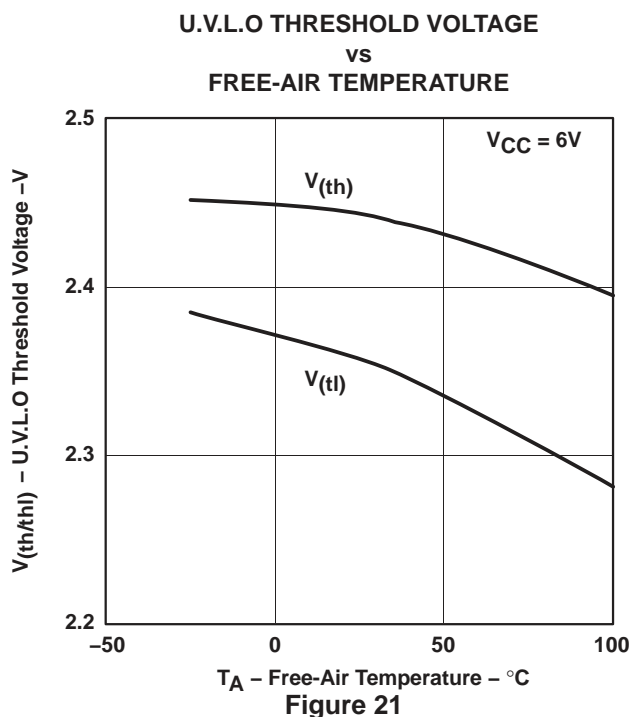
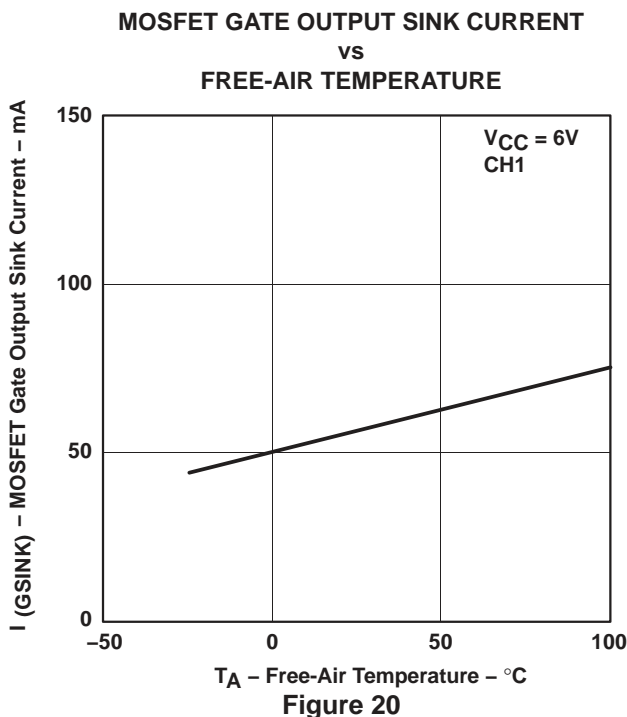

TYPICAL CHARACTERISTICS

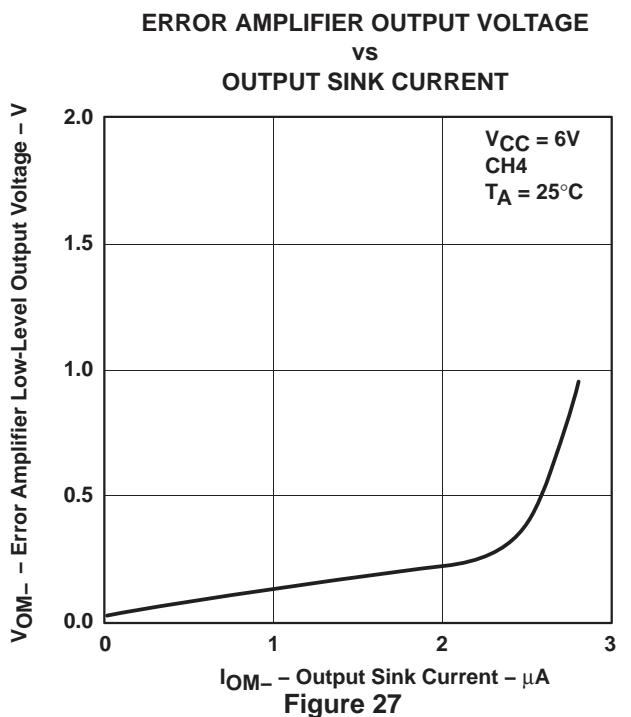
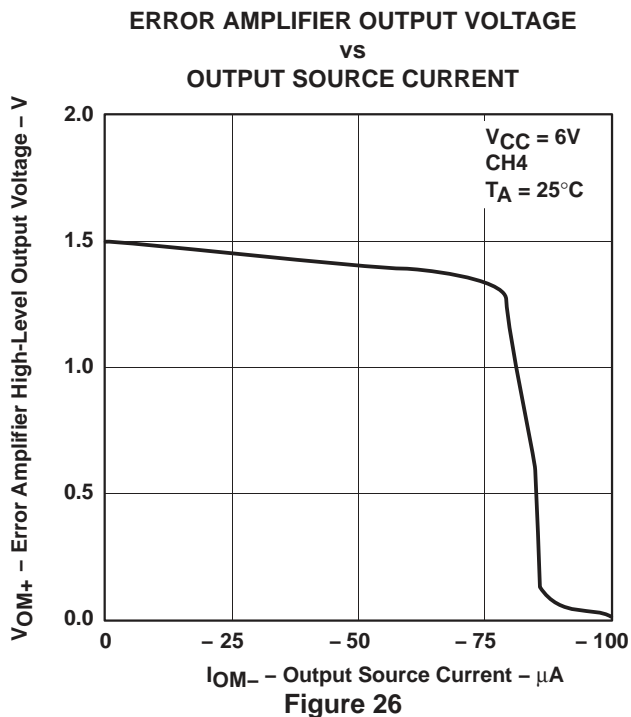
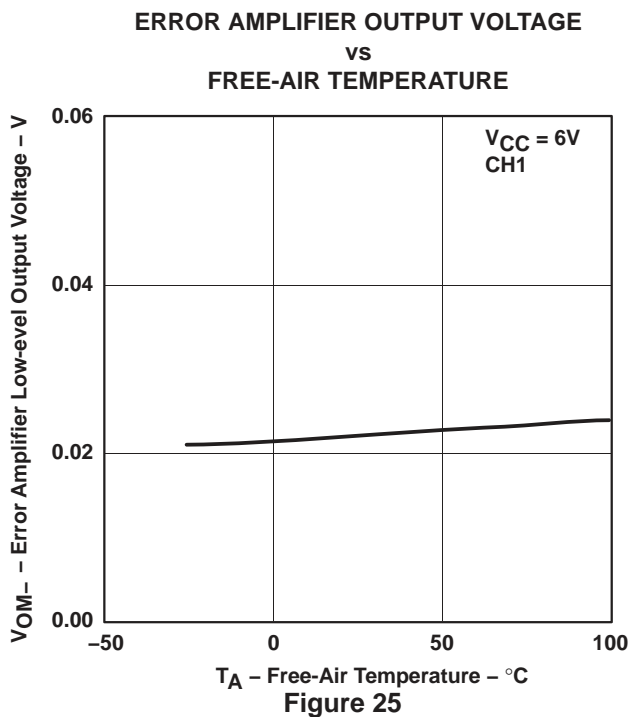
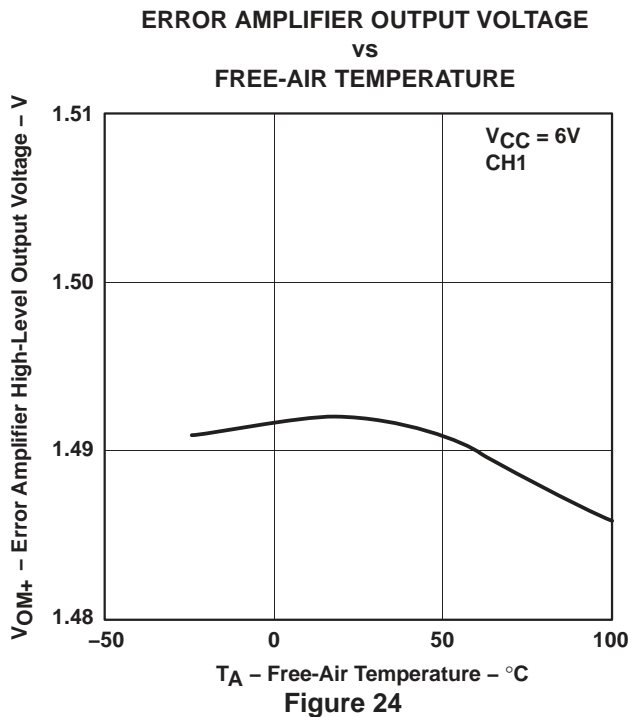

TYPICAL CHARACTERISTICS

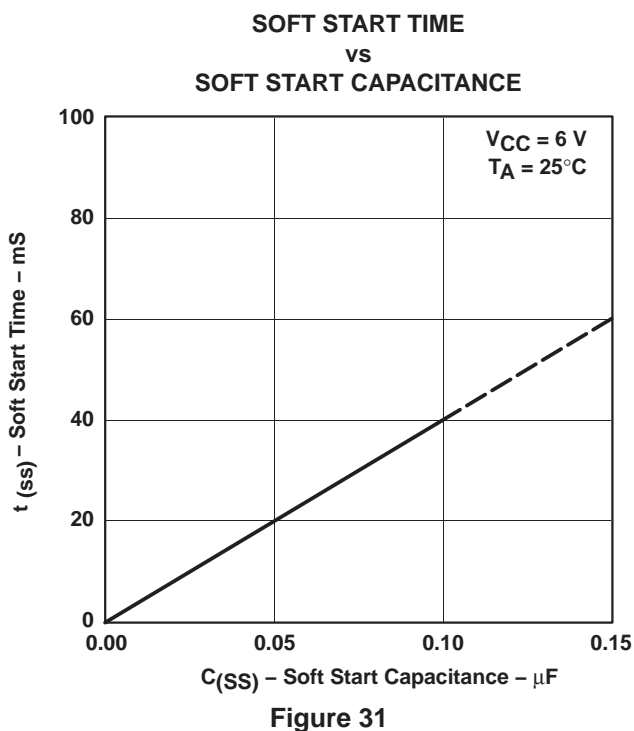
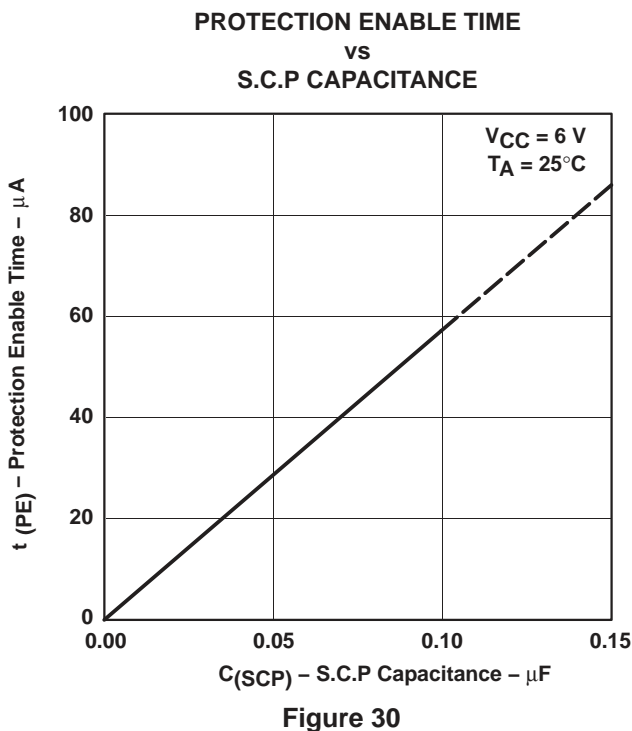
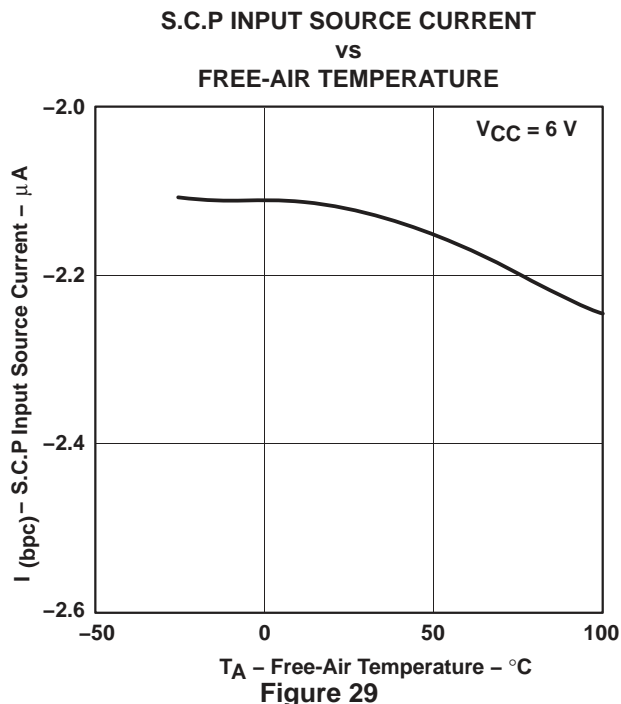
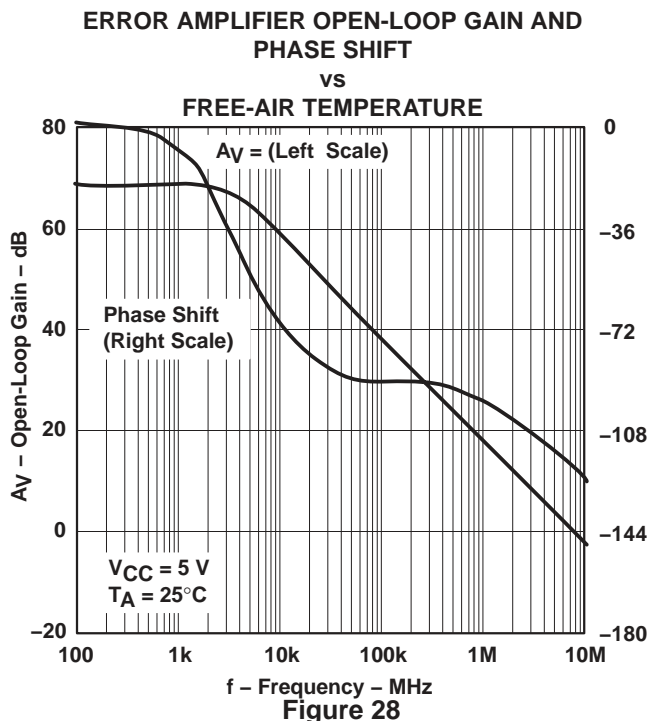

TL1466I HIGH-SPEED/PRECISION SIX CHANNEL SWITCHING REGULATOR CONTROLLER

SLVS262 – FEBRUARY 2000

APPLICATION INFORMATION

bias resistance connection for output sink current setting

The bias resistance connection to set output sink current for each output of channel 1 through 6 (OUTPUT-1 to 6) should be connected as follows (refer to Figure 32):

- For channel 1 and 3, connect OUTPUT BIAS to OUTPUT $V_{CC-1,3}$ across bias resistance.
- For channel 2, connect OUTPUT BIAS-2 to OUTPUT V_{CC-2} across bias resistance
- For channel 4, 5, and 6, connect OUTPUT BIAS to OUTPUT $V_{CC-4,5,6}$ across bias resistance.

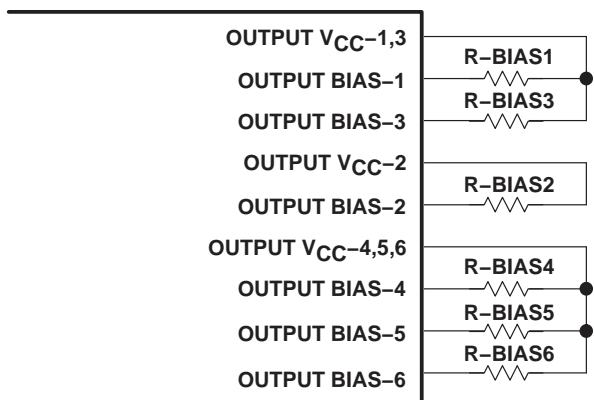

TL1466IPM

Figure 32. Bias Resistance Connection for Output Sink Current Setting

TL1466I
HIGH-SPEED/PRECISION SIX CHANNEL
SWITCHING REGULATOR CONTROLLER

SLVS262 – FEBRUARY 2000

MECHANICAL DATA

PM (S-PQFP-G64)

PLASTIC QUAD FLATPACK

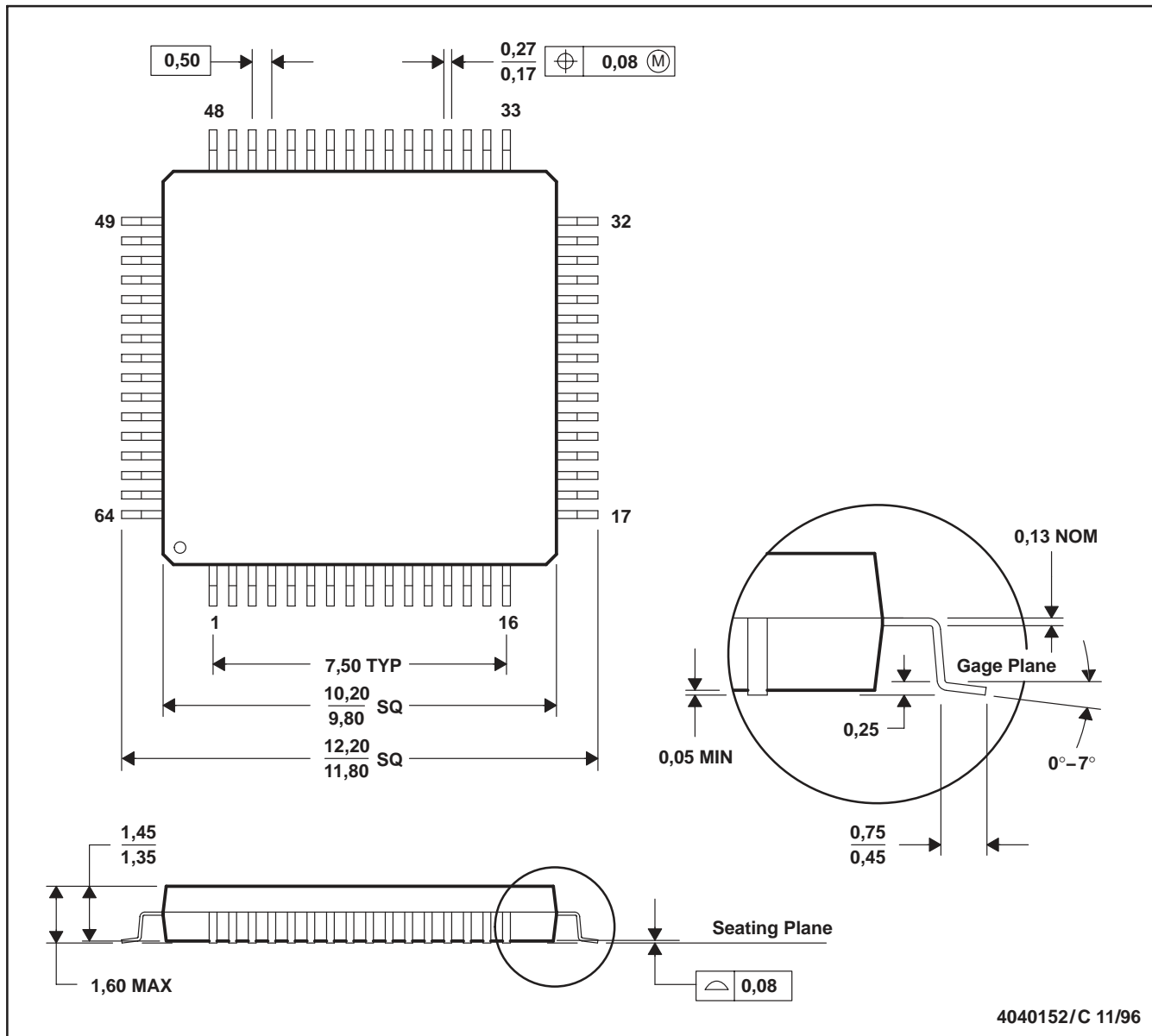

- NOTES: A. All linear dimensions are in millimeters.
 B. This drawing is subject to change without notice.
 C. Falls within JEDEC MS-026
 D. May also be thermally enhanced plastic with leads connected to the die pads.

PACKAGING INFORMATION

Orderable Device	Status ⁽¹⁾	Package Type	Package Drawing	Pins	Package Qty	Eco Plan ⁽²⁾	Lead/Ball Finish	MSL Peak Temp ⁽³⁾
TL1466IPMR	ACTIVE	LQFP	PM	64	1000	Green (RoHS & no Sb/Br)	CU NIPDAU	Level-3-260C-168 HR
TL1466IPMRG4	ACTIVE	LQFP	PM	64	1000	Green (RoHS & no Sb/Br)	CU NIPDAU	Level-3-260C-168 HR

⁽¹⁾ The marketing status values are defined as follows:

ACTIVE: Product device recommended for new designs.

LIFEBUY: TI has announced that the device will be discontinued, and a lifetime-buy period is in effect.

NRND: Not recommended for new designs. Device is in production to support existing customers, but TI does not recommend using this part in a new design.

PREVIEW: Device has been announced but is not in production. Samples may or may not be available.

OBsolete: TI has discontinued the production of the device.

⁽²⁾ Eco Plan - The planned eco-friendly classification: Pb-Free (RoHS), Pb-Free (RoHS Exempt), or Green (RoHS & no Sb/Br) - please check <http://www.ti.com/productcontent> for the latest availability information and additional product content details.

TBD: The Pb-Free/Green conversion plan has not been defined.

Pb-Free (RoHS): TI's terms "Lead-Free" or "Pb-Free" mean semiconductor products that are compatible with the current RoHS requirements for all 6 substances, including the requirement that lead not exceed 0.1% by weight in homogeneous materials. Where designed to be soldered at high temperatures, TI Pb-Free products are suitable for use in specified lead-free processes.

Pb-Free (RoHS Exempt): This component has a RoHS exemption for either 1) lead-based flip-chip solder bumps used between the die and package, or 2) lead-based die adhesive used between the die and leadframe. The component is otherwise considered Pb-Free (RoHS compatible) as defined above.

Green (RoHS & no Sb/Br): TI defines "Green" to mean Pb-Free (RoHS compatible), and free of Bromine (Br) and Antimony (Sb) based flame retardants (Br or Sb do not exceed 0.1% by weight in homogeneous material)

⁽³⁾ MSL, Peak Temp. -- The Moisture Sensitivity Level rating according to the JEDEC industry standard classifications, and peak solder temperature.

Important Information and Disclaimer:The information provided on this page represents TI's knowledge and belief as of the date that it is provided. TI bases its knowledge and belief on information provided by third parties, and makes no representation or warranty as to the accuracy of such information. Efforts are underway to better integrate information from third parties. TI has taken and continues to take reasonable steps to provide representative and accurate information but may not have conducted destructive testing or chemical analysis on incoming materials and chemicals. TI and TI suppliers consider certain information to be proprietary, and thus CAS numbers and other limited information may not be available for release.

In no event shall TI's liability arising out of such information exceed the total purchase price of the TI part(s) at issue in this document sold by TI to Customer on an annual basis.

TAPE AND REEL INFORMATION

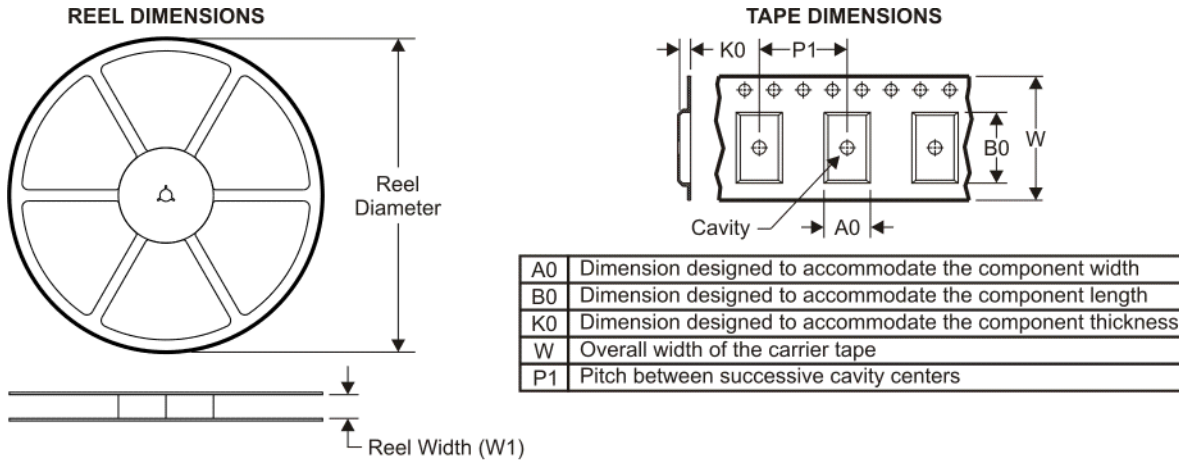

QUADRANT ASSIGNMENTS FOR PIN 1 ORIENTATION IN TAPE

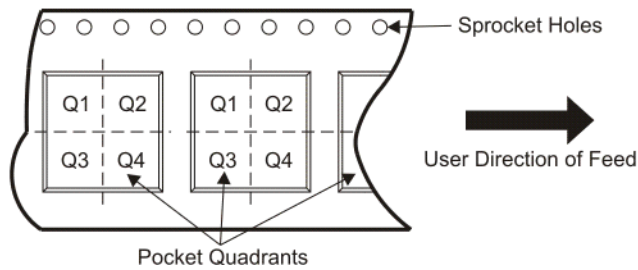

*All dimensions are nominal

Device	Package Type	Package Drawing	Pins	SPQ	Reel Diameter (mm)	Reel Width W1 (mm)	A0 (mm)	B0 (mm)	K0 (mm)	P1 (mm)	W (mm)	Pin1 Quadrant
TL1466IPMR	LQFP	PM	64	1000	330.0	24.4	12.3	12.3	2.5	16.0	24.0	Q2

TAPE AND REEL BOX DIMENSIONS



*All dimensions are nominal

Device	Package Type	Package Drawing	Pins	SPQ	Length (mm)	Width (mm)	Height (mm)
TL1466IPMR	LQFP	PM	64	1000	346.0	346.0	41.0

PM (S-PQFP-G64)

PLASTIC QUAD FLATPACK

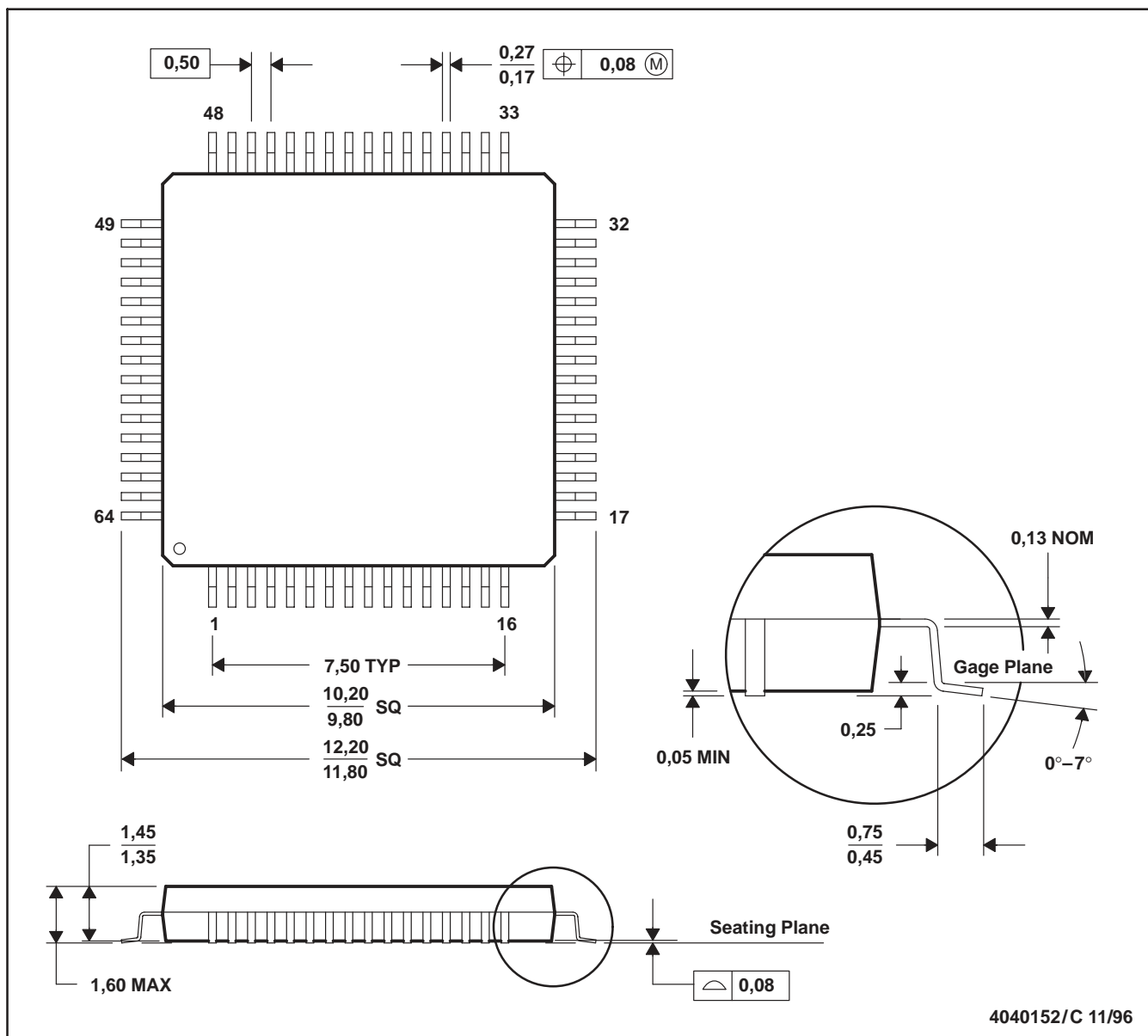

- NOTES: A. All linear dimensions are in millimeters.
 B. This drawing is subject to change without notice.
 C. Falls within JEDEC MS-026
 D. May also be thermally enhanced plastic with leads connected to the die pads.

IMPORTANT NOTICE

Texas Instruments Incorporated and its subsidiaries (TI) reserve the right to make corrections, modifications, enhancements, improvements, and other changes to its products and services at any time and to discontinue any product or service without notice. Customers should obtain the latest relevant information before placing orders and should verify that such information is current and complete. All products are sold subject to TI's terms and conditions of sale supplied at the time of order acknowledgment.

TI warrants performance of its hardware products to the specifications applicable at the time of sale in accordance with TI's standard warranty. Testing and other quality control techniques are used to the extent TI deems necessary to support this warranty. Except where mandated by government requirements, testing of all parameters of each product is not necessarily performed.

TI assumes no liability for applications assistance or customer product design. Customers are responsible for their products and applications using TI components. To minimize the risks associated with customer products and applications, customers should provide adequate design and operating safeguards.

TI does not warrant or represent that any license, either express or implied, is granted under any TI patent right, copyright, mask work right, or other TI intellectual property right relating to any combination, machine, or process in which TI products or services are used. Information published by TI regarding third-party products or services does not constitute a license from TI to use such products or services or a warranty or endorsement thereof. Use of such information may require a license from a third party under the patents or other intellectual property of the third party, or a license from TI under the patents or other intellectual property of TI.

Reproduction of TI information in TI data books or data sheets is permissible only if reproduction is without alteration and is accompanied by all associated warranties, conditions, limitations, and notices. Reproduction of this information with alteration is an unfair and deceptive business practice. TI is not responsible or liable for such altered documentation. Information of third parties may be subject to additional restrictions.

Resale of TI products or services with statements different from or beyond the parameters stated by TI for that product or service voids all express and any implied warranties for the associated TI product or service and is an unfair and deceptive business practice. TI is not responsible or liable for any such statements.

TI products are not authorized for use in safety-critical applications (such as life support) where a failure of the TI product would reasonably be expected to cause severe personal injury or death, unless officers of the parties have executed an agreement specifically governing such use. Buyers represent that they have all necessary expertise in the safety and regulatory ramifications of their applications, and acknowledge and agree that they are solely responsible for all legal, regulatory and safety-related requirements concerning their products and any use of TI products in such safety-critical applications, notwithstanding any applications-related information or support that may be provided by TI. Further, Buyers must fully indemnify TI and its representatives against any damages arising out of the use of TI products in such safety-critical applications.

TI products are neither designed nor intended for use in military/aerospace applications or environments unless the TI products are specifically designated by TI as military-grade or "enhanced plastic." Only products designated by TI as military-grade meet military specifications. Buyers acknowledge and agree that any such use of TI products which TI has not designated as military-grade is solely at the Buyer's risk, and that they are solely responsible for compliance with all legal and regulatory requirements in connection with such use.

TI products are neither designed nor intended for use in automotive applications or environments unless the specific TI products are designated by TI as compliant with ISO/TS 16949 requirements. Buyers acknowledge and agree that, if they use any non-designated products in automotive applications, TI will not be responsible for any failure to meet such requirements.

Following are URLs where you can obtain information on other Texas Instruments products and application solutions:

Products

Amplifiers	amplifier.ti.com
Data Converters	dataconverter.ti.com
DSP	dsp.ti.com
Clocks and Timers	www.ti.com/clocks
Interface	interface.ti.com
Logic	logic.ti.com
Power Mgmt	power.ti.com
Microcontrollers	microcontroller.ti.com
RFID	www.ti-rfid.com
RF/IF and ZigBee® Solutions	www.ti.com/lprf

Applications

Audio	www.ti.com/audio
Automotive	www.ti.com/automotive
Broadband	www.ti.com/broadband
Digital Control	www.ti.com/digitalcontrol
Medical	www.ti.com/medical
Military	www.ti.com/military
Optical Networking	www.ti.com/opticalnetwork
Security	www.ti.com/security
Telephony	www.ti.com/telephony
Video & Imaging	www.ti.com/video
Wireless	www.ti.com/wireless

Mailing Address: Texas Instruments, Post Office Box 655303, Dallas, Texas 75265
Copyright © 2008, Texas Instruments Incorporated