

### Features

- Schottky Barrier Chip
- Guard Ring Die Construction for Transient Protection
- Ideally Suited for Automatic Assembly
- Low Power Loss, High Efficiency
- Surge Overload Rating to 40A Peak
- For Use in Low Voltage, High Frequency Inverters, Free Wheeling, and Polarity Protection Application
- High Temperature Soldering: 260°C/10 Second at Terminal

### Mechanical Data

- Case: SMB, Molded Plastic
- Plastic Material: UL Flammability Classification Rating 94V-0
- Moisture sensitivity: Level 1 per J-STD-020A
- Terminals: Solder Plated Terminal - Solderable per MIL-STD-202, Method 208
- Also Available in Lead Free Plating (Matte Tin Finish). Please See Ordering Information, Note 4, on Page 3
- Polarity: Cathode Band or Cathode Notch
- Weight: 0.093 grams (approx.)
- Marking: B13LB

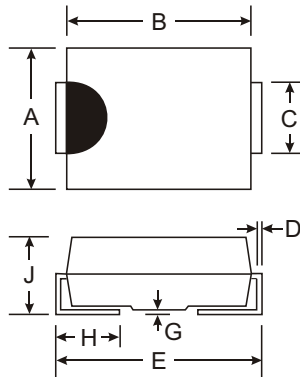

SMB		
Dim	Min	Max
A	3.30	3.94
B	4.06	4.57
C	1.96	2.21
D	0.15	0.31
E	5.00	5.59
G	0.10	0.20
H	0.76	1.27
J	2.00	2.62
All Dimensions in mm		

### Maximum Ratings and Electrical Characteristics @ T<sub>A</sub> = 25°C unless otherwise specified

Single phase, half wave, 60Hz, resistive or inductive load.  
For capacitive load, derate current by 20%.

Characteristic	Symbol	B130LB	Unit
Peak Repetitive Reverse Voltage Working Peak Reverse Voltage DC Blocking Voltage	V <sub>RRM</sub> V <sub>RWM</sub> V <sub>R</sub>	30	V
RMS Reverse Voltage	V <sub>R(RMS)</sub>	21	V
Average Rectified Output Current @ T <sub>T</sub> = 120°C @ T <sub>T</sub> = 110°C	I <sub>O</sub>	1.0 2.0	A
Non-Repetitive Peak Forward Surge Current 8.3ms Single half sine-wave Superimposed on Rated Load (JEDEC Method)	I <sub>FSM</sub>	40	A
Forward Voltage @ I <sub>F</sub> = 1.0A @ I <sub>F</sub> = 2.0A	V <sub>FM</sub>	0.395 0.445	V
Peak Reverse Current at Rated DC Blocking Voltage @ T <sub>A</sub> = 25°C @ T <sub>A</sub> = 100°C	I <sub>RM</sub>	1.0 20	mA
Typical Total Capacitance (Note 1)	C <sub>T</sub>	90	pF
Typical Thermal Resistance Junction to Terminal	R <sub>θJT</sub>	12	°C/W
Operating and Storage Temperature Range	T <sub>J</sub> , T <sub>STG</sub>	-55 to +125	°C

Notes: 1. Measured at 1.0MHz and applied reverse voltage of 4.0V DC.

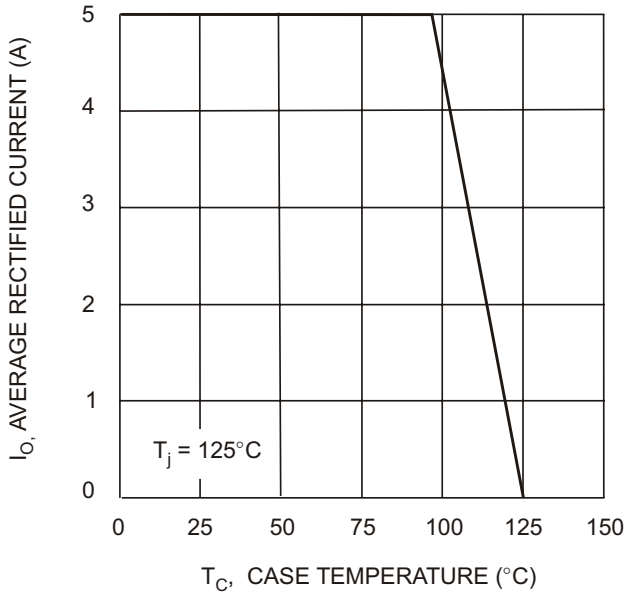

Fig. 1 Forward Current Derating Curve

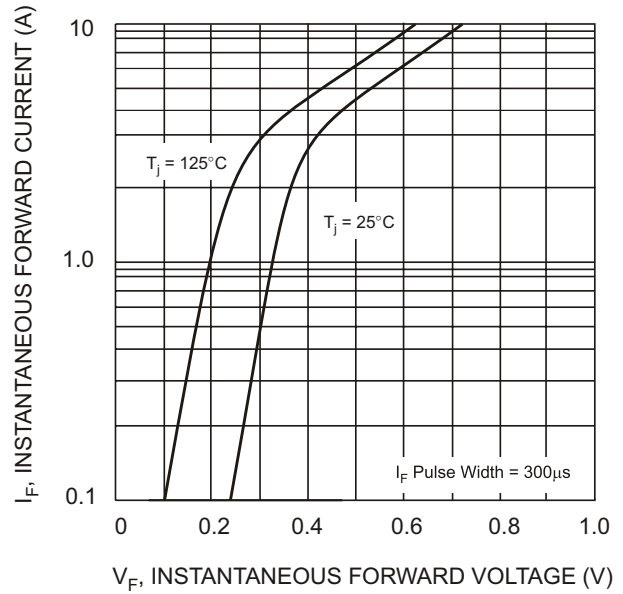

Fig. 2 Typical Forward Characteristics

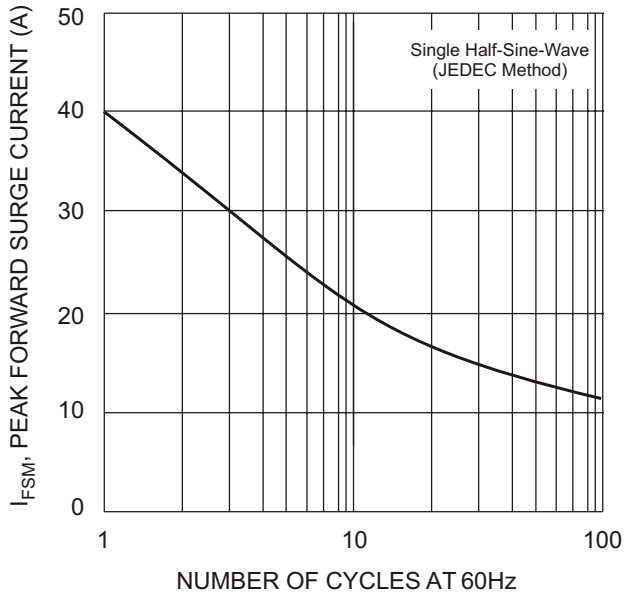

Fig. 3 Max Non-Repetitive Peak Forward Surge Current

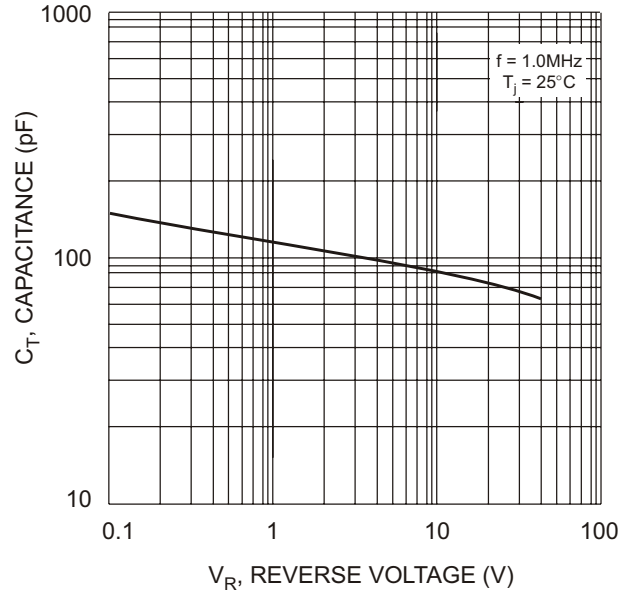

Fig. 4 Typical Total Capacitance

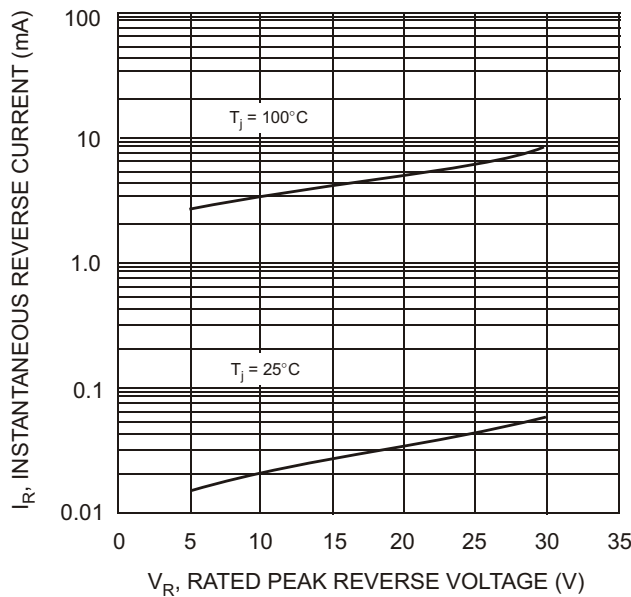
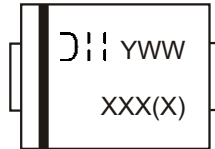

Fig. 5 Typical Reverse Characteristics

**Ordering Information** (Note 3 & 4)

Device	Packaging	Shipping
B130LB-13	SMB	3000/Tape & Reel

- Notes:
- For Packaging Details, go to our website at <http://www.diodes.com/datasheets/ap02007.pdf>.
  - For lead free terminal plating part number, please add "-F" suffix to part number above. Example: B130LB-13-F.



XXXX = Product type marking code, ex: B130LB (SMB package)  
 D = Manufacturers' code marking  
 YWW = Date code marking  
 Y = Last digit of year ex: 2 for 2002  
 WW = Week code 01 to 52  
 Band = Cathode