



Muffin XL AC - MX77A2 - 028989
 (Family) (Model) (Part Number)

Electrical Specifications

| | |
|----------------------|------------|
| Rated Voltage: | 230 VAC |
| AC Frequency: | 60 Hz |
| Power Supply: | 15.0 Watts |
| Line Current: | 0.08 Amps |
| Locked Rotor Current | 0.12 Amps |
| Nominal Speed: | 2940 RPM |



Mechanical Specifications

| | |
|-------------------------------------|---------------------------|
| Dimensions: | 4.72in x 1.50in |
| Weight | 21.0 oz |
| Max Airflow @ 0 in H ₂ O | 105.0 CFM |
| Max Pressure @ 0 CFM | 0.223 in H ₂ O |
| Noise | 47.6 dBA |



Fan Performance

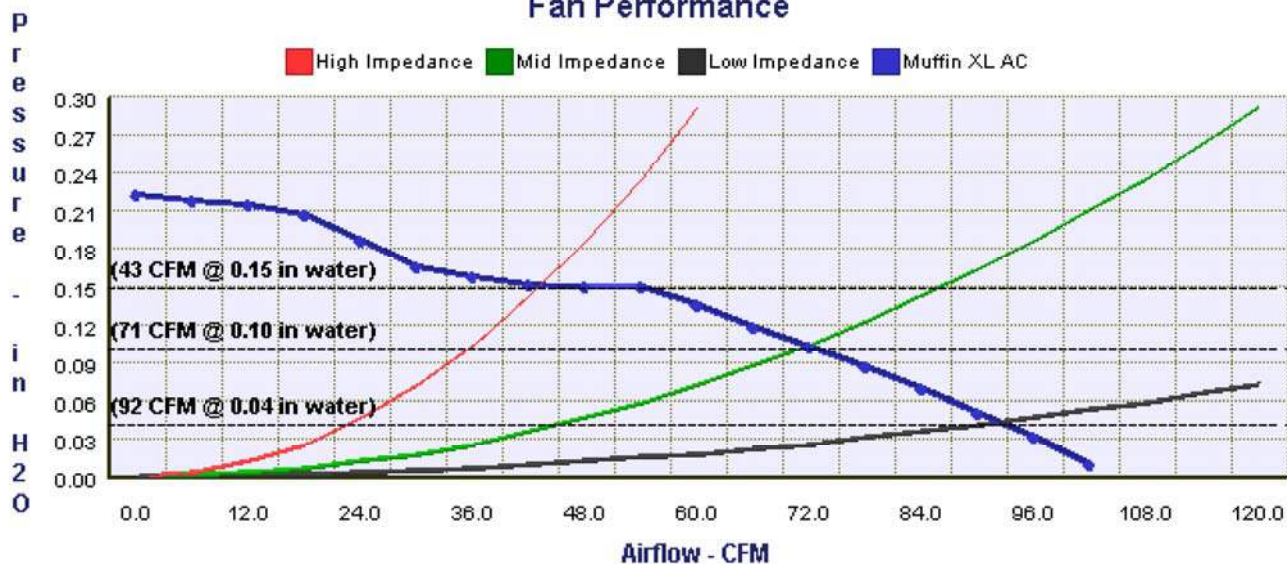

Comair Rotron, Inc.
 Phone: 619.651.2000
 sales@comairrotron.com

Comair Rotron Europe, Ltd.
 Phone: + 44.1527.520525
 saleseurope@comairrotron.com

Comair Rotron Fan Company Ltd.
 Phone: + 86.21.52260581
 salesasia@comairrotron.com

Print Date: Wednesday, November 10, 2010 at 09:56:07 - AC Fan Datasheet - Web Version 1.0 Rev. A



Mechanical Drawing

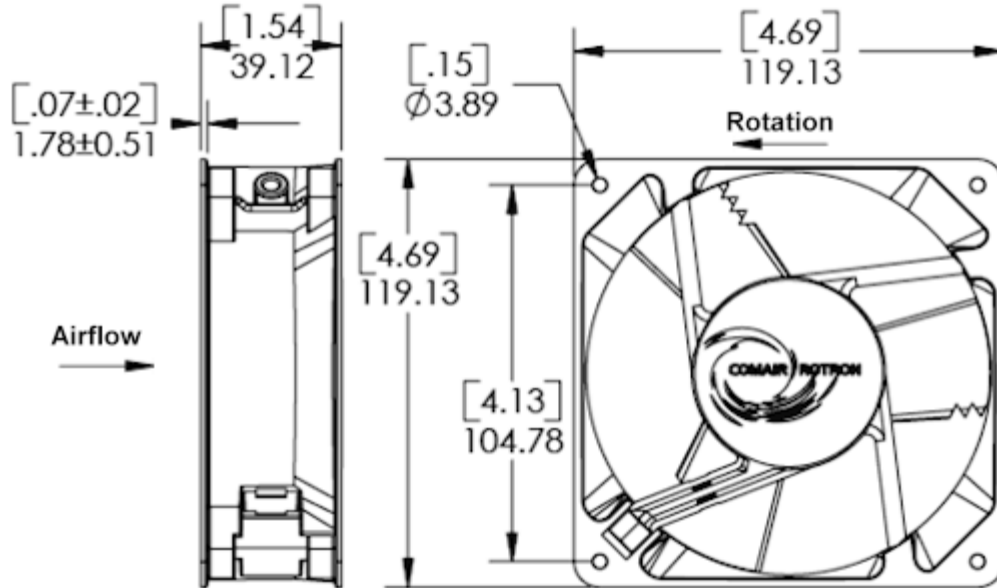

Options

| Part Number | Model Number | Bearing Type | Fan Rotation | Termination | In-Stock <small>(Click 'Yes' for current stock)</small> |
|---|--------------|--------------|--------------|-----------------|--|
| <input type="radio"/> 028793 | MX77B3 | Ball | Reverse | 0.120 Terminals | No |
| <input type="radio"/> 028781 | MX77A1 | Sleeve | Normal | 0.120 Terminals | No |
| <input checked="" type="radio"/> 028989 | MX77A2 | Sleeve | Normal | Leads | No |
| <input type="radio"/> 028792 | MX77A3 | Sleeve | Reverse | 0.120 Terminals | No |

Accessories [\(Click on part number for detailed drawing.\)](#)

428056
Plug and Cord

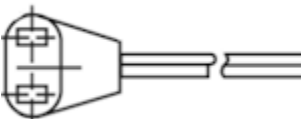

550440
Plug and Cord

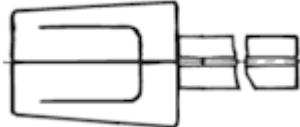

550113
Mounting Clip



551590
Filter Assembly

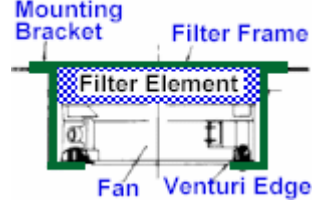

554148
Filter Guard Assembly

552934
Finger Guard

476042
Finger Guard

550481
Finger Guard

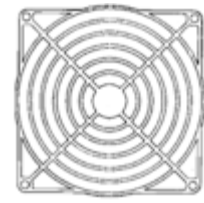
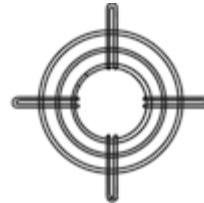
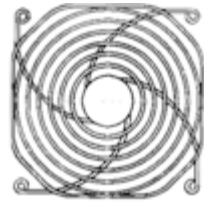
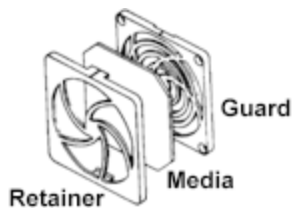

551147
Finger Guard



Comair Rotron, Inc.
Phone: 619.651.2000
sales@comairrotron.com

Comair Rotron Europe, Ltd.
Phone: + 44.1527.520525
saleseurope@comairrotron.com

Comair Rotron Fan Company Ltd.
Phone: + 86.21.52260581
salesasia@comairrotron.com

Print Date: Wednesday, November 10, 2010 at 09:56:07 - AC Fan Datasheet - Web Version 1.0 Rev. A