

Compact Power Line

CP2000AC54 Front-End Power Supply

Input: 100-120/200-240 Vac; Outputs: ± 54 Vdc at 2000W; 5 Vdc at 4W



Applications

- 48Vdc distributed power architectures
- Power over Ethernet
- Routers/Switches
- VoIP/Soft Switches
- LAN/WAN/MAN applications
- File servers
- Indoor wireless
- Telecommunications equipment
- Enterprise Networks
- SAN/NAS/iSCSI applications
- Advanced workstations

Features

- Compact 1-RU form factor providing 20 W/in³
- Constant power from 52 – 58 Vdc
- 2000W from nominal 200 – 240 Vac
- 1200W from nominal 100 – 120 Vac
- Output voltage programmable from 44V – 58 Vdc; output defaulted to 54V
- PMBus compliant dual I²C and RS485 serial bus communications
- Power factor correction (meets EN/IEC 61000-3-2 and EN 60555-2 requirements)
- Tested to IEEE802.3 Compliance, 2250 output^{***} isolation to chassis/signals for POE applications. (see ordering info)
- DC Output over-voltage and over-current protection
- AC Input over-voltage and under-voltage protection
- Over-temperature warning and protection
- Redundant, parallel operation with active load sharing and redundant +5V Aux power
- Remote ON/OFF
- Hot insertion/removal (hot plug)
- Four front panel LED indicators
- UL* Recognized to UL60950-1, CAN/ CSA[†] C22.2 No. 60950-1, and VDE[‡] 0805-1 Licensed to IEC60950-1
- CE mark meets 2006/95/EC directive[§]
- Internal variable-speed fan control

The CP2000AC54 Front-End Power Supplies in the Compact Power Line platform are specifically designed to operate as an integral part of a complete distributed power system. The high-density, front-to-back airflow rectifier is designed for minimal space utilization and is highly expandable for future growth. It is provided with many features including PoE isolation, RS485 and dual-redundant I²C communications busses that allow it to be used in a broad range of applications. The flexible feature set makes this front-end power supply an excellent choice for applications requiring modular ac-to-dc bulk intermediate voltages, such as in distributed power.

* UL is a registered trademark of Underwriters Laboratories, Inc.

† CSA is a registered trademark of Canadian Standards Association.

‡ VDE is a trademark of Verband Deutscher Elektrotechniker e.V.

§ This product is intended for integration into end-user equipment. All the required procedures for CE marking of end-user equipment should be followed. (The CE mark is placed on selected products.)

** ISO is a registered trademark of the International Organization of Standards.

*** For PoE applications, order the CP2000AC54PEZ, which is 100% factory hipot-tested per IEEE802.3.

Specifications

Input					
Parameter	Min	Typ	Max	Units	Notes
Startup Input Voltage 1200W Operation 2000W Operation			85 175		The power supply automatically configures its operating mode based on the voltage level it reads on first turn ON. (This information is retained as long as internal bias is maintained.)
Operating Voltage Range 1200W Configuration 2000W Configuration 2000W Configuration	85 175 150	120/200/240 200/240	275 275 175	Vac	If started within low input line range. If started within high input line range. Will derate to 80% of full load; will shutdown below 150Vac.
Permitted Excursions	275		300		May not meet all requirements, but will maintain output regulation.
Surges	300		325		May shut down but will not get damaged.
Input Frequency	47		63	Hz	
Input Current		13.3 11.2 11.8 9.9		A	At 100 Vac At 120 Vac At 200 Vac At 240 Vac
Inrush Transient		25	35	Apk	Measured at 25°C for all line conditions; does not include X-Capacitors charging.
Input Leakage Current		1.5		mA	Measured at 265Vac, 60Hz
Power Factor		0.98			From 50% to 100% load.
Efficiency	85 88	90 93		%	At 100 Vac with Vout > 52V and Pout > 50%. At 230 Vac with Vout > 52V and Pout > 50%.
Holdup Time		15 20		ms	Measurement starts at zero crossing of the ac voltage. Alarm issued via PFW signal going LO 5 ms prior to output voltages going out of limits. Measurements made at 65% full load and voltage allowed to decay to 49.5V. For loads below 1200W.

Main Output					
Parameter	Min	Typ	Max	Units	Notes
Maximum Output Power			1200 2000	W	At low-line input from 100-120Vac nominal. At high-line input from 200-240Vac nominal.
Output Voltage Setpoint		54		Vdc	Output floats with respect to frame ground.
Setpoint Accuracy	-1		+1	%	
Overall Regulation	-2		+2	%	Includes all variations due to specified load range, drift, and environmental conditions.
Output Voltage Margin	44 42		58 58	Vdc Vdc	Configured by hardware setting. Set either by I ² C or RS485
Maximum Output Current			23 38.5	A	At 1200W, 52V and 100-120Vac. At 2000W, 52V and 200-240Vac.
Current Share			10	%FL	Maintains tolerance to the average of all other rectifiers. Loads > 25%FL

Specifications (continued)

Output (continued)					
Parameter	Min	Typ	Max	Units	Notes
Output Ripple RMS (5Hz to 20MHz) Peak-to-Peak (5Hz to 20MHz) Psophometric Noise			250 500 2	mVrms mVpk-pk mVrms	Measured with 20MHz bandwidth under any condition of loading. Minimum load is 1A.
External Bulk Load Capacitance	0		5,000	μF	External capacitance can be increased but the power supply will not meet its turn-ON rise time requirement.
Turn-On Delay Rise Time ¹ - Standard (PMBus) -Telecom (RS-485) ² Overshoot		5 100 5		s ms s %	Monotonic Turn_On from 30% to 100% of Vnom above -5°C operation. Monotonic Turn_On from 60% to 100% of Vnom below -5°C operation.
Load Step Response ΔI ΔV Response Time		2.0 2	50	%FL Vdc ms	ΔI/Δt slew rate 1A/μs. Settling time to within regulation requirements.
Overload Power Limit Current Limit Inception ³	2000 102		108	W %FL	Down to -52Vdc Hiccup current limit. (FL = 38.5A)
Over-voltage Delayed Immediate Latchoff			60 65	Vdc Vdc	200msec delayed shutdown to be implemented. Instantaneous shutdown above this point. Three restart attempts may be implemented within a one minute window prior to a latched shutdown
Over-temperature Warning Shutdown Auto-recoverable		5 20		°C °C	Implemented prior to commencement of an OT shutdown Below the maximum rating of the device being protected Temperature hysteresis of approximately 10°C provided between shutdown and restart.

1. Below -5°C, the rise time is approximately 5 minutes to protect the bulk capacitors.

2. Complies with GR947 which calls for a minimum rise time proportional to output load.

3. Fold-down current limit is programmed as a default to permit system start-up when units are plugged in one at a time. Latch-off mode current limit can be activated via an I2c command.

Auxiliary Output					
Parameter	Min	Typ	Max	Units	Notes
Output Voltage Setpoint		5		Vdc	
Output Current	0.005		0.75	A	
Overall Regulation	-5		+10	%	
Ripple and Noise		50	100	mVpk-pk	20MHz bandwidth
Over-voltage Clamp			7	Vdc	
Over-current Limit	110		175	%FL	

Physical	
Length (in./mm)	13.85 / 351.8
Width (in./mm)	4.00 / 101.6
Height (in./mm)	1.66 / 42.2
Weight (lb/kg)	4.6 / 2.1

Specifications (continued)

Environmental					
Parameter	Min	Typ	Max	Units	Notes
Ambient Temperature Operating Ambient Derating Power Derating ²	-5 ¹	1	45 1 2	°C °C %/°C %/°C	Air inlet from sea level to 5,000 feet. Per 1,000 feet above 5,000 feet. Up to 55°C From 55 to 75 °C
Storage Temperature	-40		85	°C	
Humidity	5		95	%	Relative humidity, non-condensing
Shock and Vibration Operational Test Test Levels Drop and Tip Over					IEC 68-2 IEC 721-3-2 IEC 68-2-31
Earthquake Rating	4			Zone	Per Telcordia GR-63-CORE, all floors, when installed in CP Shelf.
Acoustic Noise		45	dBA		Noise is proportional to fan speed, load and ambient temperature.
Harmonic Emissions	Per EN/IEC61000-3-2				
Radiated Emissions ⁴	FCC and CISPR22 (EN55022) - Class B ³				
Conducted Emissions - ac	FCC and CISPR22 (EN55022) Class B Telcordia GR-1089-CORE - Class A				
Conducted Emissions - dc	Telcordia GR-1089-CORE and CISPR22 (EN55022) - Class A				
ESD	Error free per EN/IEC 61000-4-2 Level 4 (8 kV contact discharge, 15 kV air discharge).				
Radiated Immunity	Error free per EN/IEC 61000-4-3 Level 3 (10 V/m).				
Electrical Fast Transient Burst	Error free per EN/IEC 61000-4-4 Level 3 (2 kV, 5 kHz repetition rate)				
Lightning Surge Error Free Damage Free	EN/IEC61000-4-5 Level 4 (4 kV common mode, 2 kV differential mode). ANSI C62.41 Level A3 (6 kV common and differential mode)				
Conducted Immunity	Error free per EN/IEC 61000-4-6 Level 3 (10Vrms).				
Reliability (calculated)		400,000		Hours	At ambient of 25°C at full load per Telcordia SR-332, Reliability Prediction for Electronic Equipment, Method I Case III.
Isolation Input-Chassis/Signals Input - Output Output-Chassis/Signals	1500 3000 2250			Vrms Vrms Vdc	Per EN60950-1. Consult factory for testing to this requirement Per IEEE802.3.
Service Life		10		Years	25°C ambient, full load excluding fans.

1. Designed to start at an ambient as low as -40°C, but may not meet operational limits until above -5°C.
2. Power derating shall consider only temperature variations at nominal line (100 – 120, 200 – 240Vrms). The unit may derate faster if the input line is below nominal.
3. Class B radiated emissions compliance requires the addition of a ferrite bead to each power line cord at the shelf-end of the cable. See the figure below.
4. Radiated emissions compliance was met using a Lineage Power shelf. This shelf includes output common and differential mode capacitors that assist in meeting compliance.

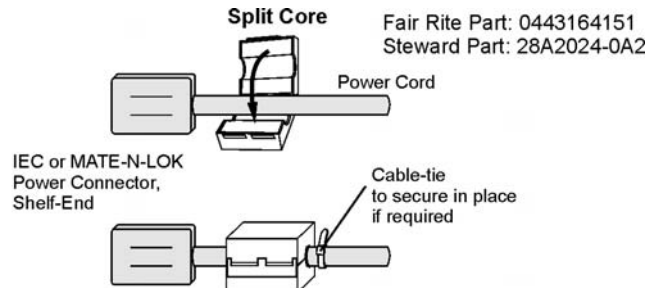
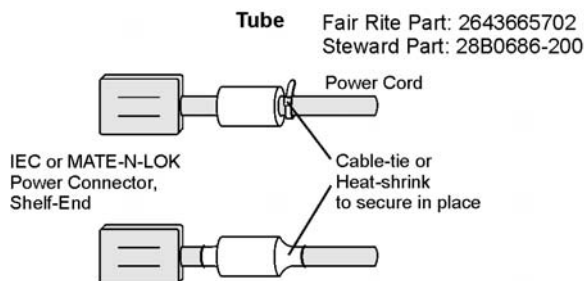

Status and Control

The rectifier provides three means for monitor/control: analog, PMBus compliant I²C, or RS485 for interfacing to Lineage Power controllers or battery plants.

Details of analog controls are provided in this data sheet under Signal Definitions. Lineage Power will provide separate application notes on PMBus protocol for users to interface to the CPL rectifiers. Contact your local Lineage Power representative for details.

Hot Plug

When rapidly extracting and reinserting modules care should be taken to allow for discharging the internal bias supply so that a predictable restart could be achieved. The way to ensure that the circuit sufficiently discharges is to observe the spinning of the fans after an extraction. The unit should not be reinserted until the fans stop spinning.

Control Definitions

All signals are referenced to Logic GRD unless otherwise noted. See the Signal Definitions Table at the end of this document for further description of all the signals.

Input Signals

Margining: Setpoint of the rectifier can be changed via this input pin. Programming can be either a voltage source or a resistance divider. The margining pin is connected to 3.3Vdc via a 10kΩ resistor inside the rectifier. See graphs below.

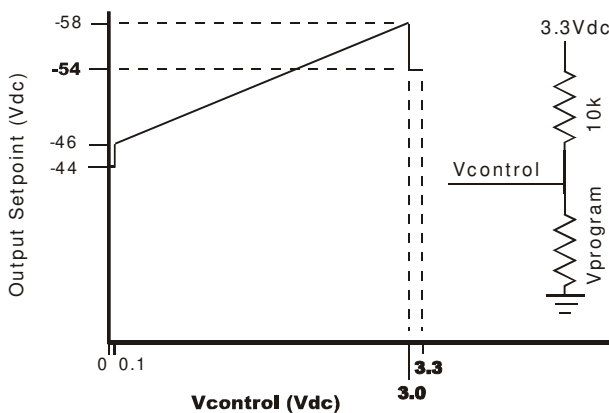

An open circuit on this pin reverts the voltage level back to the original setting.

Module Present Signal: This signal has dual functionality. It can be used to alert the system when a module is inserted. Has a 500Ω resistor in series between this signal and Logic GRD. An external pull-up should not raise the voltage on the pin above 0.25Vdc. If raised the pin is raised to 5Vdc the write_protect feature of the EEPROM is enabled.

Protocol Select: Establishes the communications mode of the power supply, between analog/I²C and RS485 modes. For RS485, connect a 10kΩ pull-down resistor to 54_OUT(-DC).

Enable: On/Off control when either PMBus communications or analog functions are utilized as configured by the Protocol pin. This pin must be pulled low to turn **ON** the main output of the power supply. The power supply will turn **OFF** if either the **Enable** or the **ON/OFF** pin is released. The **Enable** function does not work with the RS-485 protocol. This signal is referenced to Logic_GRD.

ON/OFF: This is a short pin utilized for hot-plug applications to ensure that the power supply turns **OFF** before the power pins are disengaged. It also ensures that the power supply turns **ON** only after the power pins have been engaged. Must be connected to 54_OUT (-DC).

Output Signals

Alert #: PMBus interrupt signal.

Fault: This signal goes LO for any failure that requires rectifier replacement. Some of these faults may be due to:

- Fan failure
- Over-temperature condition
- Over-temperature shutdown
- Over-voltage shutdown
- Internal Rectifier Fault

Power Capacity: A HI on this pin indicates rectifier configured for 2000W operation; a LO indicates rectifier configured for 1200W operation.

Alarm Table

Condition	Power Supply LED State				Monitoring Signals (Referenced to Logic_GRD)			
	AC OK Green	DC OK Green	Service Amber	Fault Red	Fault	OTW	PFW	Module Present
OK	1	1	0	0	HI	HI	HI	LO
Thermal Alarm (5C before shutdown)	1	1	1	0	HI	LO	HI	LO
Thermal Shutdown	1	0	1	1	LO	LO	LO	LO
Defective Fan	1	0	0	1	LO	HI	LO	LO
Blown AC Fuse in Unit	1	0	0	1	LO	HI	LO	LO
No AC <15mS (single unit)	0	1	0	0	HI	HI	LO ³	LO
AC Present but not within limits	Blinks	0	0	0	HI	HI	LO	LO
AC not present ¹	0	0	0	0	HI	HI	LO	LO
Boost Stage Failure	1	0	0	1	LO	HI	LO	LO
Over Voltage Latched Shutdown	1	0	0	1	LO	HI	LO	LO
Over Current	1	Blinks	0	0	HI	HI	LO	LO
Non-catastrophic Internal Failure ²	1	1	0	1	LO	HI	HI	LO
1 Missing Module								HI
Standby (remote)	1	0	0	0	HI	HI	LO	LO
Service Request (PMBus mode)	1	1	Blinks	0	HI	HI	HI	LO
Communications Fault (RS485 mode)	1	1	0	Blinks	HI	HI	HI	LO

¹ This signal is correct if the rectifier is back biased from other rectifiers in the shelf .

² Any detectable fault condition that does not result in the power supply shutting down. For example, ORing FET failure, boost section out of regulation, etc.

³ Signal transition from HI to LO is output load dependent

Output Connector

Mating Connector: AMP 1450572-1

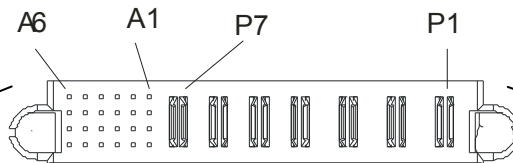



	Signal						Output Power		Input Power				
	6	5	4	3	2	1	P7	P6	P5	P4	P3	P2	P1
A	SCL_0	MOD_PRES	PFW	LOGIC_GRD	RS_485+	UNIT_ADDR	54_OUT (-DC)	54_OUT (+DC)	Reserved	EARTH (GND)	LINE-2 (Neutral)	LINE-1 (Line)	
B	SCL_1	OTW	Alert#_0	Alert#_1	RS_485-	8V_INT							
C	SDA_0	Margin	Enable	Reset	Ishare	Protocol							
D	SDA_1	Fault	5VA	Power_Cap	ON/OFF	SHELF_ADDR							

Connector is viewed from the rear positioned inside the power supply.

Signal pins columns 1 and 2 are referenced to 54_OUT (-DC).

Signal pins columns 3 through 6 are referenced to Logic GRD.

 Last-to-make first-to-break pins.

 First-to-make last-to-break longest pin implemented in the mating connector.

Signal Definitions

All hardware alarm signals (Fault, PFW, OTW, Power Capacity) are open drain FETs. These signals should be pulled HI to either 3.3V or 5V. Maximum sink current 5mA. An active LO signal (< 0.4Vdc). All signals are referenced to Logic GRD unless otherwise stated. Contact your Lineage Power representative for more details.

Function	Label	Type	Description
Output Enable	Enable	Input	If shorted to LOGIC_GRD, the rectifier output is enabled when using I ² C mode of operation. May also be toggled to reset a latched OFF rectifier. Function not available in RS485 mode.
Power Fail Warning	PFW	Output	An open drain FET; normally HI, indicating output power is present. Changes to LO at least 5msec before the output voltage is lost.
I ² C Interrupt	Alert#_0 Alert#_1	Output	Interrupt signal via I ² C lines indicating that service is requested from the host controller. This signal pin is pulled up to 3.3V via a 10kΩ resistor and switches to active LO when an interrupt occurs.
Rectifier Fault	Fault	Output	Indicates that an internal fault exists. An open drain FET; normally HI, changes to LO.
Module Present	MOD_PRES	Output	Short pin, see Status and Control description for further information on this signal.
ON/OFF	ON/OFF	Input	Short pin, connects last and breaks first; used to activate and deactivate output during hot-insertion and extraction, respectively. Ref: 54_OUT (-DC)
Protocol select	Protocol	Input	See Status and Control description for further information on this signal. Ref: 54_OUT (-DC).
Margining	Margin	Input	Allows changing of output voltage through an analog voltage input or via resistor divider.
Over-Temperature Warning	OTW	Output	An open drain FET; normally HI, changes to LO approximately 5°C prior to thermal shutdown.
Power Capacity	POWER_CAP	Output	An open drain FET; Used to indicate rectifier operation mode; HI indicates 2000W operation and LO indicates 1200W operation.
Rectifier address	Unit_addr	Input	Voltage level addressing of rectifiers within a single shelf. Ref: 54_OUT (-DC).
Shelf Address	Shelf_addr	Input	Voltage level addressing of rectifiers within multiple shelves. Ref: 54_OUT (-DC).
Back bias	8V_INT	—	Diode OR'ed 8Vdc drain; used to back bias microprocessors and DSP of failed rectifier from operating rectifiers. Ref: 54_OUT (-DC).
Mux Reset	Reset	Input	Resets the I ² C lines to I ² C line 0.
Standby power	5VA	Output	5V at 0.75A provided for external use by either adjacent power supplies or the using system.
Current Share	Ishare	-	A single wire interface between each of the power unit forces them to share the load current. Ref: 54_OUT (-DC).
I ² C Line 0	SCL_0, SDA_0	Input	I ² C line 0.
I ² C Line 1	SCL_1, SDA_1	Input	I ² C line 1.
RS485 Line	RS_485+ RS_485-	Input	RS485 line.

Front Panel LEDs

	Analog Mode	I ² C Mode	RS485 Mode
<input type="checkbox"/> ~	←	ON: Input ok Blinking: Input out of limits	→
<input type="checkbox"/> ...	←	ON: Output ok Blinking: Overload	→
<input type="checkbox"/> *	ON: Over-temperature Warning	ON: Over-temperature Warning Blinking: Service	ON: Over-temperature Warning
<input type="checkbox"/> !	← ON: Fault →		ON: Fault Blinking: Not communicating

Dimensions

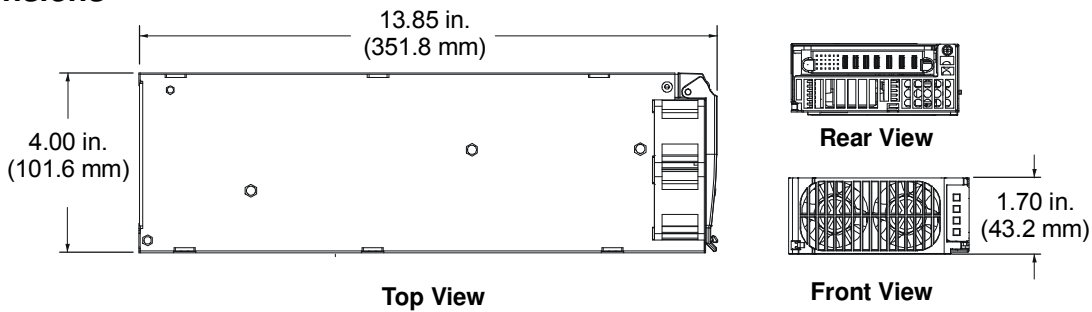

Ordering Information

Item	Description	Comcode
CP2000AC54PE	Designed to IEEE802.3 POE compliance, RoHS 5/6	CC109120722
CP2000AC54PEZ	Tested to IEEE802.3 POE compliance, RoHS 6/6	CC109139408



World Wide Headquarters
Lineage Power LLC
 601 Shiloh Road, Plano, TX 75074, USA
+1-800-526-7819
 (Outside U.S.A.: +1-972-284-2626)
www.lineagepower.com
e-mail: techsupport1@lineagepower.com

Asia-Pacific Headquarters
 Tel: +65 6593 7211

Europe, Middle-East and Africa Headquarters
 Tel: +49 898 780 672 80

India Headquarters
 Tel: +91 80 2841 1633

Lineage Power reserves the right to make changes to the product(s) or information contained herein without notice. No liability is assumed as a result of their use or application. No rights under any patent accompany the sale of any such product(s) or information.

© 2009 Lineage Power LLC, (Mesquite, Texas) All International Rights Reserved.
 Revision : GGS-April 2010