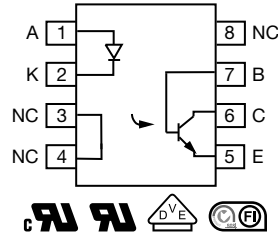
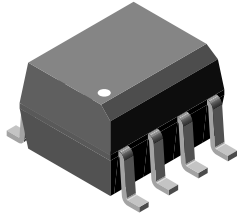


Optocoupler, Phototransistor Output, With Base Connection in SOIC-8 Package



FEATURES

- High BV_{CEO} , 70 V
- Isolation test voltage, 4000 V_{RMS}
- Industry standard SOIC-8A surface mountable package
- Compatible with dual wave, vapor phase and IR reflow soldering
- Material categorization: for definitions of compliance please see www.vishay.com/doc?99912


RoHS
COMPLIANT

LINKS TO ADDITIONAL RESOURCES



DESCRIPTION

The IL205AT, IL206AT, IL207AT, IL208AT are optically coupled pairs with a gallium arsenide infrared LED and a silicon NPN phototransistor. Signal information, including a DC level, can be transmitted by the device while maintaining a high degree of electrical isolation between input and output. This family comes in a standard SOIC-8 small outline package for surface mounting which makes them ideally suited for high density application with limited space. In addition to eliminating through-hole requirements, this package conforms to standards for surface mounted devices.

A specified minimum and maximum CTR allows a narrow tolerance in the electrical design of the adjacent circuits. The high BV_{CEO} of 70 V gives a higher safety margin compared to the industry standard 30 V.

AGENCY APPROVALS

- [UL](#)
- [cUL](#)
- [DIN EN 60747-5-5 \(VDE 0884\)](#), available with option 1
- [FIMKO](#)

ORDERING INFORMATION				
<div style="display: flex; justify-content: space-around; align-items: center;"> <div style="border: 1px solid black; padding: 2px 5px;">I</div> <div style="border: 1px solid black; padding: 2px 5px;">L</div> <div style="border: 1px solid black; padding: 2px 5px;">2</div> <div style="border: 1px solid black; padding: 2px 5px;">0</div> <div style="border: 1px solid black; padding: 2px 5px;">#</div> <div style="border: 1px solid black; padding: 2px 5px;">A</div> <div style="border: 1px solid black; padding: 2px 5px;">T</div> </div> <p style="text-align: center; margin-top: 5px;">PART NUMBER TAPE AND REEL</p>				
AGENCY CERTIFIED / PACKAGE	CTR (%)			
	10 mA			
UL, cUL, FIMKO	40 to 80	63 to 125	100 to 200	160 to 320
SOIC-8	IL205AT	IL206AT	IL207AT	IL208AT
UL, cUL, FIMKO, VDE (option 1)	40 to 80	63 to 125	100 to 200	160 to 320
SOIC-8	-	-	IL207A-X001T	-

Note

- Additional options may be possible, please contact sales office



ABSOLUTE MAXIMUM RATINGS ($T_{amb} = 25\text{ }^{\circ}\text{C}$, unless otherwise specified)				
PARAMETER	TEST CONDITION	SYMBOL	VALUE	UNIT
INPUT				
Peak reverse voltage		V_R	6	V
Forward continuous current		I_F	60	mA
Power dissipation		P_{diss}	90	mW
Derate linearly from 25 °C			1.2	mW/°C
OUTPUT				
Collector emitter breakdown voltage		BV_{CEO}	70	V
Emitter collector breakdown voltage		BV_{ECO}	7	V
Collector-base breakdown voltage		BV_{CBO}	70	V
$I_{CMAX\ DC}$		$I_{CMAX\ DC}$	50	mA
I_{CMAX}	$t < 1\text{ ms}$	I_{CMAX}	100	mA
Power dissipation		P_{diss}	150	mW
Derate linearly from 25 °C			2	mW/°C
COUPLER				
Isolation test voltage		V_{ISO}	4000	V_{RMS}
Total package dissipation (LED and detector)		P_{tot}	240	mW
Derate linearly from 25 °C			3.3	mW/°C
Operating temperature		T_{amb}	-55 to +100	°C
Storage temperature		T_{stg}	-55 to +150	°C
Soldering time	At 260 °C		10	s

Note

- Stresses in excess of the absolute maximum ratings can cause permanent damage to the device. Functional operation of the device is not implied at these or any other conditions in excess of those given in the operational sections of this document. Exposure to absolute maximum ratings for extended periods of the time can adversely affect reliability.

ELECTRICAL CHARACTERISTICS ($T_{amb} = 25\text{ }^{\circ}\text{C}$, unless otherwise specified)						
PARAMETER	TEST CONDITION	SYMBOL	MIN.	TYP.	MAX.	UNIT
INPUT						
Forward voltage	$I_F = 10\text{ mA}$	V_F	-	1.3	1.5	V
Reverse current	$V_R = 6\text{ V}$	I_R	-	0.1	100	μA
Capacitance	$V_R = 0\text{ V}$	C_O	-	13	-	pF
OUTPUT						
Collector emitter breakdown voltage	$I_C = 100\text{ }\mu\text{A}$	BV_{CEO}	70		-	V
Emitter collector breakdown voltage	$I_E = 100\text{ }\mu\text{A}$	BV_{ECO}	7	10	-	V
Collector emitter leakage current	$V_{CE} = 10\text{ V}$	I_{CEO}	-	5	50	nA
COUPLER						
Saturation voltage, collector emitter	$I_C = 2\text{ mA}$, $I_F = 10\text{ mA}$	V_{CEsat}	-	-	0.4	V
Capacitance, input to output		C_{IO}	-	0.5	-	pF
Resistance, input to output		R_{IO}	-	100	-	$\text{G}\Omega$

Note

- Minimum and maximum values were tested requirements. Typical values are characteristics of the device and are the result of engineering evaluations. Typical values are for information only and are not part of the testing requirements.

CURRENT TRANSFER RATIO							
PARAMETER	TEST CONDITION	PART	SYMBOL	MIN.	TYP.	MAX.	UNIT
Current transfer ratio	$I_F = 10 \text{ mA}, V_{CE} = 5 \text{ V}$	IL205AT	CTR	40	-	80	%
		IL206AT	CTR	63	-	125	%
		IL207AT	CTR	100	-	200	%
		IL208AT	CTR	100	-	320	%
	$I_F = 1 \text{ mA}, V_{CE} = 5 \text{ V}$	IL205AT	CTR	13	25	-	%
		IL206AT	CTR	22	40	-	%
		IL207AT	CTR	34	60	-	%
		IL208AT	CTR	56	95	-	%

SWITCHING CHARACTERISTICS							
PARAMETER	TEST CONDITION	PART	SYMBOL	MIN.	TYP.	MAX.	UNIT
Switching time	$I_C = 2 \text{ mA}, R_L = 100 \Omega, V_{CC} = 10 \text{ V}$		t_{on}, t_{off}	-	3	-	μs

SAFETY AND INSULATION RATINGS							
PARAMETER	TEST CONDITION	SYMBOL	MIN.	TYP.	MAX.	UNIT	
Climatic classification	According to IEC 68 part 1		-	55 / 110 / 21	-		
Pollution degree (DIN VDE 0109)			-	2.0	-		
Comparative tracking index		CTI	175	-	399		
V_{IOTM}	DIN IEC 112 / VDE 0303 part 1, group IIIa per DIN VDE 6110 175 399	V_{IOTM}	6000	-	-	V	
V_{IORM}		V_{IORM}	560	-	-	V	
Resistance (input to output)		R_{IO}	-	10^{12}	-	Ω	
P_{SI}			-	-	350	mW	
I_{SI}			-	-	150	mA	
T_{SI}			-	-	165	$^{\circ}\text{C}$	
Creepage distance			4.0	-	-	mm	
Clearance distance			4.0	-	-	mm	

Note

- As per IEC 60747-5-5, §7.4.3.8.1, this optocoupler is suitable for “safe electrical insulation” only within the safety ratings. Compliance with the safety ratings shall be ensured by means of protective circuits.

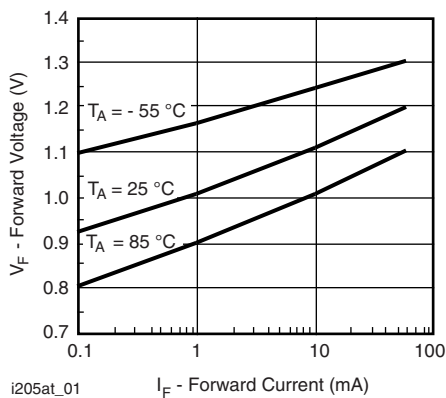
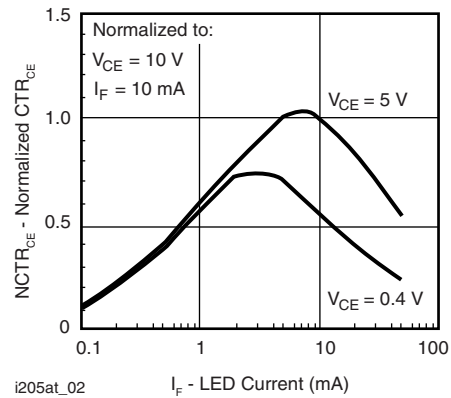
TYPICAL CHARACTERISTICS ($T_{amb} = 25 \text{ }^{\circ}\text{C}$, unless otherwise specified)


Fig. 1 - Forward Voltage vs. Forward Current


 Fig. 2 - Normalized Non-Saturated and Saturated CTR_{CE} vs. LED Current

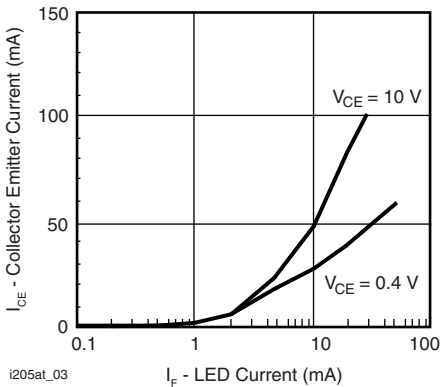


Fig. 3 - Collector Emitter Current vs. LED Current

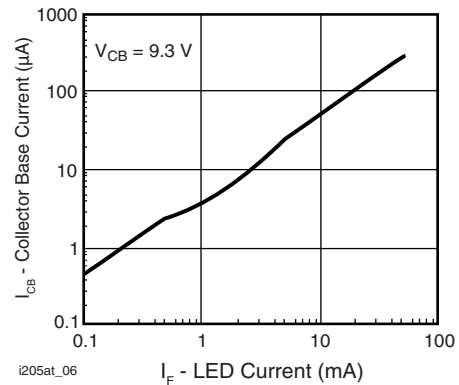


Fig. 6 - Collector Emitter Photocurrent vs. LED Current

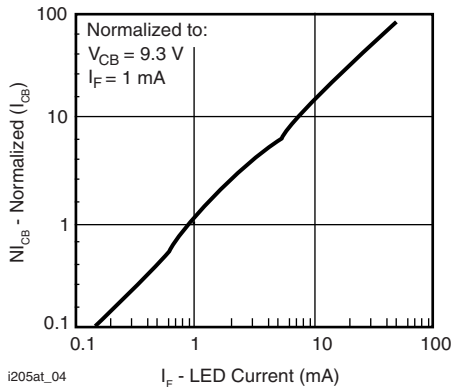


Fig. 4 - Normalized Collector-Base Photocurrent vs. LED Current

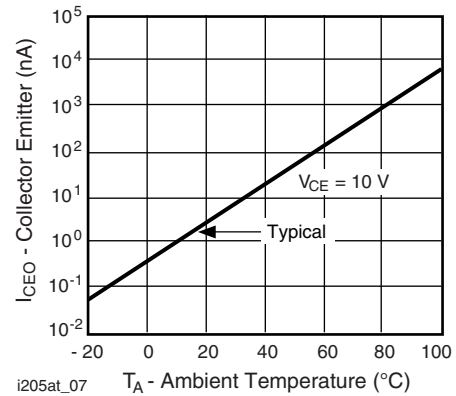


Fig. 7 - Collector Emitter Photocurrent vs. LED Current

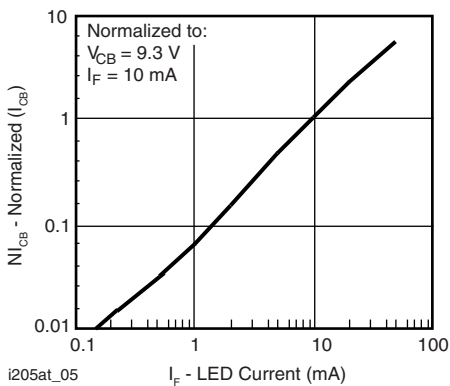


Fig. 5 - Normalized Collector-Base Photocurrent vs. LED Current

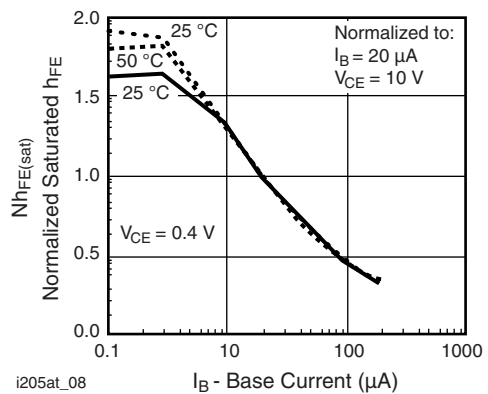
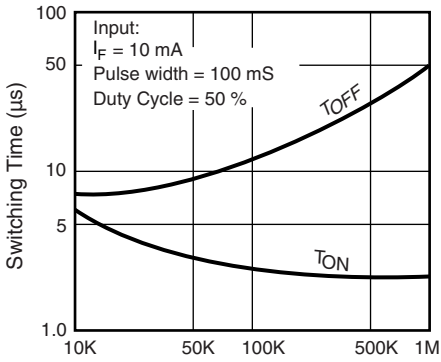
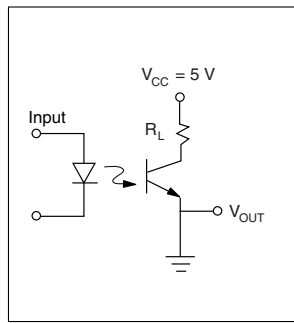


Fig. 8 - Base Current vs. I_F and h_{FE}



i205at_09 Base Emitter Resistance, R_{BE} (Ω)

Fig. 9 - Typical Switching Characteristics vs. Base Resistance (Saturated Operation)



i205at_11

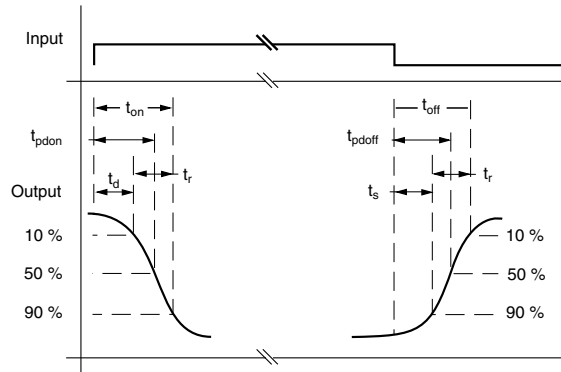
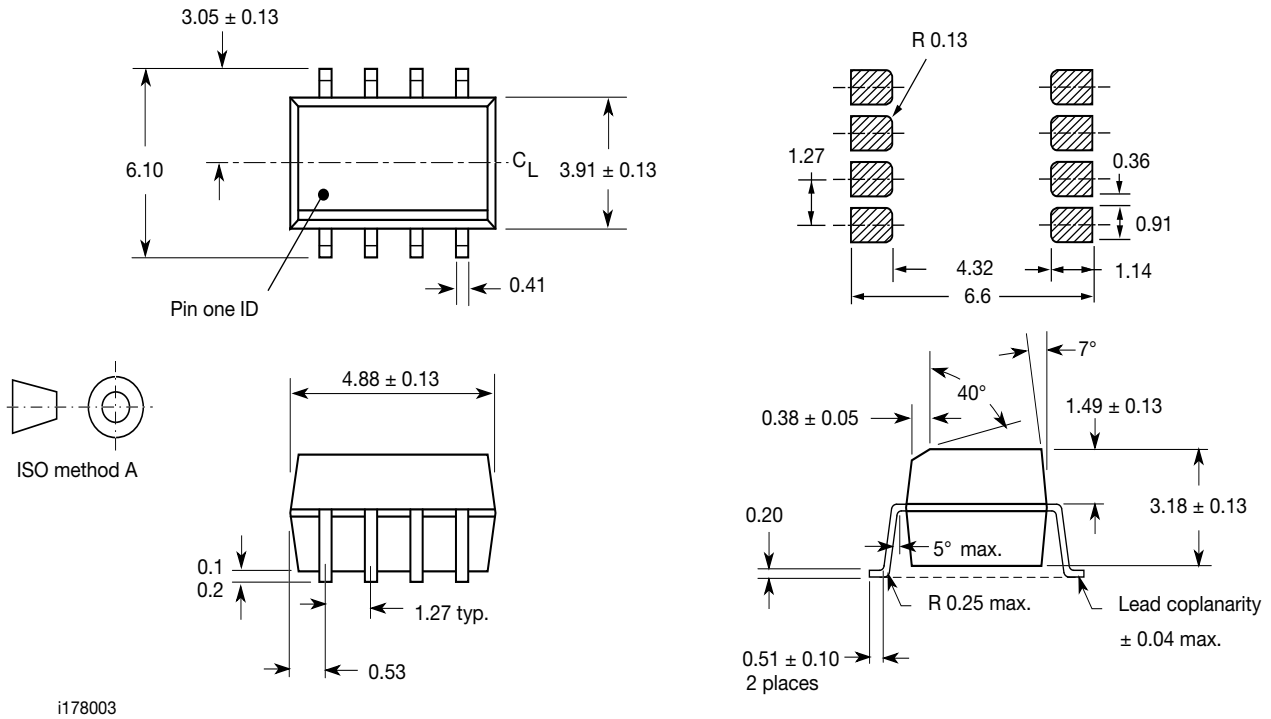


Fig. 10 - Switching Test Circuit

PACKAGE DIMENSIONS in millimeters



i178003

PACKAGE MARKING (example)

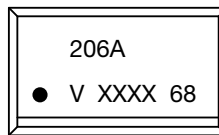


Fig. 11 - Example of IL206AT

Notes

- XXXX = LMC (lot marking code)
- Tape and reel suffix (T) is not part of the package marking



Disclaimer

ALL PRODUCT, PRODUCT SPECIFICATIONS AND DATA ARE SUBJECT TO CHANGE WITHOUT NOTICE TO IMPROVE RELIABILITY, FUNCTION OR DESIGN OR OTHERWISE.

Vishay Intertechnology, Inc., its affiliates, agents, and employees, and all persons acting on its or their behalf (collectively, "Vishay"), disclaim any and all liability for any errors, inaccuracies or incompleteness contained in any datasheet or in any other disclosure relating to any product.

Vishay makes no warranty, representation or guarantee regarding the suitability of the products for any particular purpose or the continuing production of any product. To the maximum extent permitted by applicable law, Vishay disclaims (i) any and all liability arising out of the application or use of any product, (ii) any and all liability, including without limitation special, consequential or incidental damages, and (iii) any and all implied warranties, including warranties of fitness for particular purpose, non-infringement and merchantability.

Statements regarding the suitability of products for certain types of applications are based on Vishay's knowledge of typical requirements that are often placed on Vishay products in generic applications. Such statements are not binding statements about the suitability of products for a particular application. It is the customer's responsibility to validate that a particular product with the properties described in the product specification is suitable for use in a particular application. Parameters provided in datasheets and / or specifications may vary in different applications and performance may vary over time. All operating parameters, including typical parameters, must be validated for each customer application by the customer's technical experts. Product specifications do not expand or otherwise modify Vishay's terms and conditions of purchase, including but not limited to the warranty expressed therein.

Hyperlinks included in this datasheet may direct users to third-party websites. These links are provided as a convenience and for informational purposes only. Inclusion of these hyperlinks does not constitute an endorsement or an approval by Vishay of any of the products, services or opinions of the corporation, organization or individual associated with the third-party website. Vishay disclaims any and all liability and bears no responsibility for the accuracy, legality or content of the third-party website or for that of subsequent links.

Except as expressly indicated in writing, Vishay products are not designed for use in medical, life-saving, or life-sustaining applications or for any other application in which the failure of the Vishay product could result in personal injury or death. Customers using or selling Vishay products not expressly indicated for use in such applications do so at their own risk. Please contact authorized Vishay personnel to obtain written terms and conditions regarding products designed for such applications.

No license, express or implied, by estoppel or otherwise, to any intellectual property rights is granted by this document or by any conduct of Vishay. Product names and markings noted herein may be trademarks of their respective owners.