





## COMPANY HISTORY

AMERICAN ELECTRICAL, INC. WAS FOUNDED IN 1997 BY THOMAS MCCORMICK, FORMER VICE PRESIDENT OF SALES FOR WEIDMULLER, INC. THE COMPANY CONCEPT WAS BORN OVER LUNCH WITH FELLOW ASSOCIATES LITERALLY ON A NAPKIN. AMERICAN ELECTRICAL, INC. WAS DEVELOPED WITH A SPECIAL GERMAN SUPPLIER RELATIONSHIP – WHO AFTER A BUSINESS MEETING PROVIDED MCCORMICK WITH A PRICE LIST AND A HANDSHAKE. THE COMPANY FLOURISHED DUE TO STRONG FRIENDSHIPS, BUSINESS RELATIONSHIPS, AND PEOPLE WHO WERE UNAFRAID TO HELP A NEW ORGANIZATION GROW. MCCORMICK WILL NEVER FORGET THOSE SPECIAL PEOPLE AND DISTRIBUTORS WHO FIRST HELPED HIM GET STARTED – THANK YOU.

MCCORMICK DREAMED OF A COMPANY THAT RESPONDED QUICKLY, SHIPPED ON TIME AND PROVIDED QUALITY PRODUCTS AT A GREAT PRICE. HE ENVISIONED A WORKPLACE THAT WAS NOT COMPARTMENTALIZED, ONE WHERE EACH PERSON COULD BE RESPONSIBLE FOR THE CUSTOMER THROUGHOUT THE ENTIRE SPECIFICATION/ORDER CHAIN. HE FELT THE SATISFACTION OF THE EMPLOYEES WOULD CREATE A POWERFUL CUSTOMER SERVICE ENTITY WHICH IN RETURN WOULD CREATE CUSTOMER LOYALTY.

MCCORMICK BUILT THE PRODUCT LINES OFFERED BY PARTNERING WITH COMPANIES WHO SPECIALIZED IN A PRODUCT AREA BUT WERE SMALLER IN SCOPE – THE BUSINESSES THAT WERE LOOKING TO BREAK INTO THE U.S. INDUSTRIAL MARKET, BUT WITH NO INTENTIONS OF PUTTING UP BRICK AND MORTAR. TODAY, AMERICAN ELECTRICAL, INC. HAS 10 PRODUCT LINES AND IS STILL GROWING. OUR DEDICATED EMPLOYEES ALL WORK HARD TO SERVE OUR VALUED CUSTOMERS – HELPING THEM TO “THINK INSIDE THE BOX.”

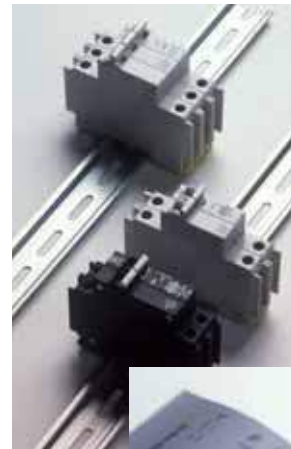

## QUALITY STATEMENT

AMERICAN ELECTRICAL, INC. IS A SUPPLIER OF HIGH QUALITY INDUSTRIAL ELECTRICAL ACCESSORIES. ALL OF OUR PRODUCTS ARE MANUFACTURED IN ACCORDANCE TO INTERNATIONAL STANDARDS, SUCH AS UL, CSA, CE AND MORE.

### **RoHS** (EU DIRECTIVE 2002/95/EC):

WE CERTIFY ALL OF OUR PRODUCTS COMPLY WITH THE RoHS DIRECTIVE OF JANUARY 27, 2003. ALL PRODUCT LINES ARE FREE OF BANNED SUBSTANCES TO INCLUDE LEAD, MERCURY, CADMIUM, HEXAVALENT CHROMIUM, PBB AND PBDE.



## OUR CORE BELIEFS

WE HAVE AN ACRONYM WE CALL “FAST” THAT HAS BOTH A TRUE AND UNDERLYING MEANING. OF COURSE THE UNDERLYING MESSAGE TO OUR CUSTOMERS IS THAT WE TRY TO DO THINGS AS QUICKLY AS POSSIBLE. WHETHER THAT’S A QUOTATION, PRICE CHECK, AVAILABILITY QUESTION, SHIPPING OR INFORMATION REQUEST – WE DO IT NOW – WE KNOW AND UNDERSTAND THAT THERE ARE EAGER CUSTOMERS OR POTENTIAL CUSTOMERS WAITING ON US AND THEIR TIME IS AS VALUABLE AS OURS.

OUR WORD FAST ALSO HAS A DEFINITIVE MEANING:

**F** – TO BE FLEXIBLE IN OUR ABILITY TO SERVE THE CUSTOMER, TO BE ABLE TO EFFECTIVELY WEAR THE DIFFERENT “HATS” THAT ARE REQUIRED IN A SMALLER ORGANIZATION AND TO HAVE THE CUSTOMERS’ SERVICE ISSUES IN MIND AT ALL TIMES.

**A** – TO BE ACCURATE IN EVERYTHING WE DO – FROM SPECIFICATION TO DELIVERY. WE UNDERSTAND THE CONSEQUENCES OF MISTAKES AND THE DOMINO EFFECT THEY CAN HAVE ON THE PRACTICES OF OUR CUSTOMERS AND OUR COMBINED BUSINESSES. MISTAKES COST MONEY AND TIME. WE SEEK THE PROPER TRAINING TO INSURE THAT WE FOLLOW THE CORRECT PROCEDURES AND HAVE THE PRODUCT KNOWLEDGE NECESSARY TO BE CORRECT. WE KNOW THAT WE NEED TO DO IT RIGHT ALL THE TIME TO ELIMINATE THE NECESSITY TO DO IT OVER.

**S** – TO ACT WITH SPEED IN ALL THAT WE DO. WE KNOW THE CUSTOMER WAITS FOR OUR RESPONSE OR OUR PRODUCTS AND WE DO NOT NEED TO WASTE THAT TIME – FOR WE UNDERSTAND THAT TIME IS MONEY. WE WANT TO BE ABLE TO SHIP TODAY, QUOTE AND SPECIFY NOW, FAX IMMEDIATELY, CONFIRM ORDERS ON RECEIPT – RESPOND NOW. FOR WE KNOW THAT THIS WILL WIN OUR CUSTOMERS’ SUPPORT AND FUTURE BUSINESS AND TRUST.

**T** – TO ACT AS A TEAM SO THAT OUR EFFORT IS MULTIPLIED TO PRODUCE A MUCH GREATER RESULT FOR OUR CUSTOMERS. TO HAVE THE POSITIVE ATTITUDE THAT IS SO COMMON IN WINNERS. THE UNDERSTANDING THAT PEOPLE WANT TO BE WINNERS AND WORK WITH WINNERS – WITH PEOPLE WHO ARE SUCCESSFUL NOT ONLY IN WHAT THEY DO BUT HOW THEY WORK TOGETHER. WE ARE A TEAM WHO ACTS AS ONE ON BEHALF OF OUR DEDICATED CUSTOMERS, WHOM WE WOULD BE NOTHING WITHOUT.





## TABLE OF CONTENTS



<b>TERMINAL BLOCKS</b> .....	.6
AVK SERIES .....	.8
PEK SERIES .....	.12
YBK SERIES .....	.16



<b>WIRE FERRULES</b> .....	.36
INSULATED FERRULES .....	.38
FERRULES ON STRIPS .....	.40
FERRULES ON REELS .....	.40
TWO WIRE FERRULES .....	.41
UNINSULATED FERRULES .....	.42
ASSORTMENT BOXES .....	.44



<b>TOOLS</b> .....	.52
WIRE FERRULE HAND CRIMPING TOOLS .....	.53
CRIMP MAX MC 25 .....	.56
PNEUMATIC CRIMPERS .....	.58
AUTOMATIC WIRE CUTTER .....	.59
UNINSULATED FERRULES .....	.42
ASSORTMENT BOXES .....	.44



<b>DIN RAIL</b> .....	.60
STEEL DIN RAIL .....	.61
ALUMINUM DIN RAIL .....	.62
DIN RAIL CUTTER .....	.62



<b>DIN RAIL MOUNTED POWER SUPPLIES</b> .....	.63
--	-----



<b>DIN RAIL MOUNTED CIRCUIT BREAKERS</b> .....	.71
UL 1077 RATED .....	.72
UL 489 RATED .....	.72
UL 489A RATED .....	.73



**DIN RAIL MOUNTED FUSE HOLDERS** .....74



**DIN RAIL MOUNTED INTERFACE MODULES** .....76



**DIN RAIL MOUNTED DISCONNECT SWITCHES** .....78



**CABLE GRIPS** .....81  
METALLIC CABLE GRIPS .....85  
SYNTHETIC CABLE GRIPS .....87  
LOCK NUTS .....90  
LOCKING PLUGS .....92



**PRINTED CIRCUIT BOARDS** .....96  
TERMINAL BLOCKS .....97  
PLUGS .....100  
HEADERS .....102



**SCREWDRIVERS** .....106

**ALPHA-NUMERIC INDEX** .....108



## **DIN RAIL MOUNTED TERMINAL BLOCKS**

AMERICAN ELECTRICAL OFFERS THE KLEMSAN LINE OF COST, SPACE AND TIME SAVING TERMINAL BLOCKS. THE TERMINAL BLOCKS ARE DIN RAIL MOUNTABLE AND CAN BE INSTALLED INTO VARIOUS CONFIGURATIONS QUICKLY. KLEMSAN HAS OVER 30 YEARS OF TERMINAL BLOCK HISTORY WITH ALL INTERNATIONAL APPROVALS. AMERICAN ELECTRICAL AND KLEMSAN PARTNERED IN 2002 TO BE THE FIRST AND ONLY SUPPLIER OF KLEMSAN TERMINAL BLOCKS IN THE UNITED STATES.

MODULAR TERMINAL BLOCKS ARE USED WORLDWIDE. OUR TERMINAL BLOCKS ARE USED IN ANY MACHINE CONTROL INTERFACE APPLICATION. WE SELL INTO THE PROCESS AND MACHINE CONTROL MARKETS AS WELL AS BUILDING AUTOMATION.

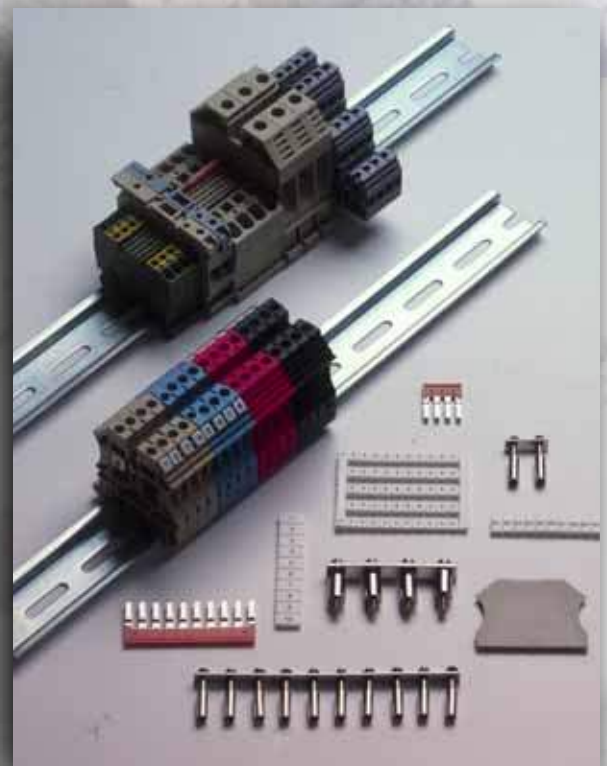

## MATERIALS AND FUNCTION

**HOUSINGS** – THE PLASTIC HOUSING HOLDING THE METALLIC SCREWS AND CLAMPS IS MADE OF UL 94 V2 (105 DEGREE C) THERMOPLASTIC POLYAMIDE 6.6. THIS PLASTIC AND ITS CERTIFICATION ALLOW OPERATION RATED AT 600V, PROVIDING AMPLE DIELECTRIC STRENGTH FOR ANY INDUSTRIAL APPLICATION.

**CLAMPS** - STEEL IS ONE OF THE STRONGEST MATERIALS AVAILABLE FOR ITS VALUE. THE CLAMPS ARE ZINC PLATED TO GUARD AGAINST CORROSION. WHEN PROPERLY TORQUED, THE CLAMP IS DESIGNED TO SELF-LOCK.

**SCREWS** – MADE OF STEEL AS WELL, THE SCREWS ACT AS A SYSTEM WITH THE CLAMPS – THIS SYSTEM REQUIRES THE SAME MATERIALS FOR EACH COMPONENT. THE SCREWS LIFT AND HELP TO SELF-LOCK THE CLAMPS PROVIDING A DOWNWARD FORCE ONTO THE CONDUCTORS. THE SCREWS ARE ALSO PLATED WITH A ZINC FINISH TO PREVENT ANY FORM OF CORROSION.

## CONNECTION TYPES

### SCREW CONNECTION

THIS IS THE MOST POPULAR OF ALL KNOWN CONNECTION METHODS. SCREW CONNECTION REFERS TO ANY CONNECTION IN WHICH THE CONDUCTOR IS STRIPPED OF ITS INSULATION AND CLAMPED WITHOUT ANY PREPARATION.

WHEN THE SCREW IS TIGHTENED, THE PRESSURE PULLS APART BOTH HALVES OF THE CLAMPING YOKE. THIS GENERATES A HIGH LOCKING ACTION ON THE SCREW AND PROVIDES EXCELLENT VIBRATION RESISTANCE.

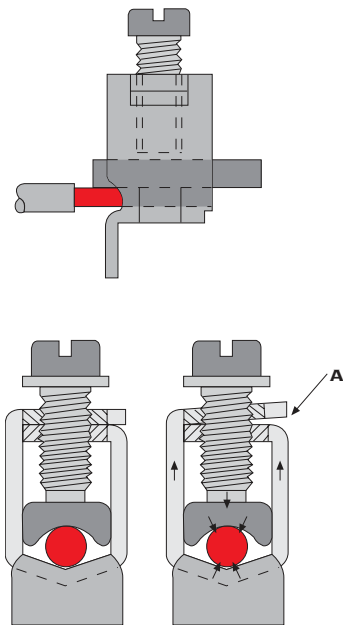

## TENSION CLAMP SYSTEM

TENSION CLAMP CONNECTION ALLOWS THE CONDUCTOR TO BE PRESSED DIRECTLY AGAINST THE CURRENT BAR. THE CLAMP IS OPENED WITH A SCREWDRIVER ALLOWING THE INSERTION OF THE CONDUCTOR.

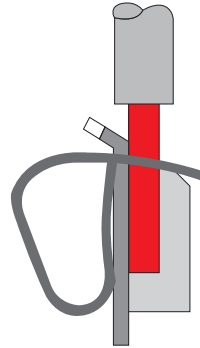

## ACCESSORIES

**END PLATE** – TERMINAL BLOCKS ARE MANUFACTURED WITH ONE OPEN END ALLOWING SIDE BY SIDE PLACEMENT. AN END PLATE IS NECESSARY FOR THE LAST TERMINAL BLOCK IN THE ASSEMBLY ENABLING FULL ENCLOSURE.

**PARTITION** – THE PARTITION ALLOWS VISUAL SEPARATION OF CIRCUITS AND FOR ELECTRICAL SEPARATION DUE TO ADJACENT CROSS CONNECTIONS.

**END BRACKET** – TO PREVENT TERMINAL BLOCKS FROM FALLING OFF THE DIN RAIL, THEY MUST BE SECURED ON EACH SIDE. THIS IS ACCOMPLISHED WITH END BRACKETS SCREWED ONTO THE RAIL. TWO END BRACKETS ARE NECESSARY – ONE ON EACH SIDE OF THE CONTINUOUS ASSEMBLY DESIGNED.

**CROSS CONNECTIONS** – CROSS CONNECTIONS DISTRIBUTE POTENTIALS WITHIN AN ASSEMBLY. STANDARD POLES OF 2, 3, 4, OR 10 ARE AVAILABLE TO SATISFY YOUR DESIGN REQUIREMENTS

**MARKING TAG** – MARKING TAGS ARE USED FOR CIRCUIT IDENTIFICATION AND EASIER TROUBLESHOOTING. WE HAVE MANY NUMBERS AND LETTERS AVAILABLE THAT WILL MAKE YOUR DESIGNED ASSEMBLY UNIQUE. HORIZONTAL MARKERS FOR DIN RAIL MOUNTED HORIZONTALLY AND VERTICAL FOR ASSEMBLIES MOUNTED VERTICALLY.





# AVK SERIES

## FEED-THROUGH TERMINALS AND ACCESSORIES

AVK TYPE TERMINALS ARE MANUFACTURED FROM THERMOPLASTIC RAW MATERIAL. GREY BEING THE MAIN COLOR, FIVE DIFFERENT COLORS GIVE USERS ADDITIONAL CHOICES FOR VISUAL SEPARATION OF CONTROL CIRCUITS AND/OR VOLTAGE LEVELS.



### AVK 2.5

WIDTH 5 MM  
304 120

### AVK 4

WIDTH 6 MM  
304 130

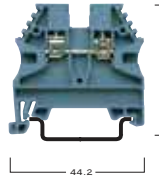

TORQUE: 0.4 NM

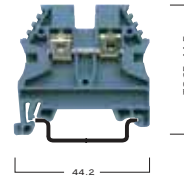

TORQUE: 0.5 NM

COLORS	TERMINALS	END PLATE	PARTITION
	PART NUMBER	PART NUMBER	PART NUMBER
	<b>AVK 2.5</b>	<b>NPP</b>	<b>APP</b>
GREY	304 120	444 120	462 120
BLUE	304 121	444 121	462 121
GREEN	304 122	444 122	462 122
YELLOW	304 123	444 123	462 123
RED	304 124	444 124	462 124
BEIGE	304 129	444 129	462 129
	<b>AVK 4</b>	<b>NPP</b>	<b>APP</b>
GREY	304 130	444 120	462 120
BLUE	304 131	444 121	462 121
GREEN	304 132	444 122	462 122
YELLOW	304 133	444 123	462 123
RED	304 134	444 124	462 124
BEIGE	304 139	444 129	462 129
	<b>AVK 6</b>	<b>NPP</b>	<b>APP</b>
GREY	304 140	444 120	462 120
BLUE	304 141	444 121	462 121
GREEN	304 142	444 122	462 122
YELLOW	304 143	444 123	462 123
RED	304 144	444 124	462 124
BEIGE	304 149	444 129	462 129
	<b>AVK 10</b>	<b>NPP</b>	<b>APP</b>
GREY	304 150	444 120	462 120
BLUE	304 151	444 121	462 121
GREEN	304 152	444 122	462 122
YELLOW	304 153	444 123	462 123
RED	304 154	444 124	462 124
BEIGE	304 159	444 129	462 129
	<b>AVK 16</b>	<b>NPP</b>	<b>APP</b>
GREY	304 160	444 160	462 160
BLUE	304 161	444 161	462 161
GREEN	304 162	444 162	462 162
YELLOW	304 163	444 163	462 163
RED	304 164	444 164	462 164
BEIGE	304 169	444 169	462 169
	<b>AVK 35</b>		
GREY	304 170		
BLUE	304 171		
GREEN	304 172		
YELLOW	304 173		
RED	304 174		
BEIGE	304 179		
	<b>AVK 70</b>		
GREY	304 190		
BLUE	304 191		
GREEN	304 192		
YELLOW	304 193		
RED	304 194		
BEIGE	304 199		

### ELECTRICAL RATINGS

VOLTAGE/CURRENT/CROSS-SECTION

VDE (IEC 60947-7-1)

UL / CSA

ATEX

INSULATION STRIPPING LENGTH

### CONNECTION DATA

SOLID STRAND, SCREW CONNECTION

FINE STRAND, SCREW CONNECTION

### ORDERING DATA

POLYAMIDE 6.6 GREY

### MOUNTING RAILS

TS 35X7.5 SOLID TS 35X15 SOLID  
TS 35X7.5 SLOTTED TS 35X15 SLOTTED

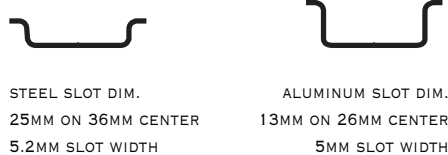

### END BRACKET

THICKNESS 8MM GREY  
KD 3

### END PLATE - PARTITION

THICKNESS 1.5MM  
POLYAMIDE 6.6  
NPP

### SMALL PARTITION

GREY  
AD1

### CROSS CONNECTION

UK 2.5/2 474 122 25 UK 4/2 474 132 25  
UK 2.5/3 474 123 20 UK 4/3 474 133 20  
UK 2.5/4 474 124 15 UK 4/4 474 134 15  
UK 2.5/10 474 129 5 UK 4/10 474 139 5

### TEST PLUG-Soc. / INS. TEST Soc.

TF ITK TSK

### WARNING LABEL

IP WITH SYMBOL WITHOUT SYMBOL

### GROUP MARKING

GREY  
GE GE 2

### MARKING TAGS

SEE PAGE 34 FOR FURTHER DETAIL.

750V ~ / 26 A / 2.5 MM <sup>2</sup>	750V ~ / 34 A / 4 MM <sup>2</sup>
750V ~ / 24 A / 2.5 MM <sup>2</sup>	750V ~ / 32 A / 4 MM <sup>2</sup>
600V ~ / 20 A / AWG 26-12	600V ~ / 30 A / AWG 26-10
630V ~ / 21 A / 2.5 MM <sup>2</sup>	400V ~ / 28 A / 4 MM <sup>2</sup>
10MM	10 MM
0.5 - 4 MM <sup>2</sup>	0.5 - 6 MM <sup>2</sup>
1.5 - 2.5 MM <sup>2</sup>	1.5 - 4 MM <sup>2</sup>
26 - 12	26 - 10
PART No. STD. Pk.	PART No. STD. Pk.
<b>304 120 100</b>	<b>304 130 100</b>
TYPE PART No. STD.Pk	TYPE PART No. STD.Pk.
SLOTTED	SLOTTED
35x7.5 <b>TS3575SL</b> 2M	35x7.5 <b>TS3575SL</b> 2M
35x7.5 <b>TS3575SL1</b> 1M	35x7.5 <b>TS3575SL1</b> 1M
35x7.5 <b>TS3575SL1-A</b> 1M	35x7.5 <b>TS3575SL1-A</b> 1M
35x15 <b>TS3515SL</b> 2M	35x15 <b>TS3515SL</b> 2M
SOLID	SOLID
35x7.5 <b>TS3575SOL</b> 2M	35x7.5 <b>TS3575SOL</b> 2M
35x15 <b>TS3515SOL</b> 2M	35x15 <b>TS3515SOL</b> 2M
KD 3 <b>495 049</b> 100	KD 3 <b>495 049</b> 100
NPP 2.5-10 <b>444 120</b> 100	NPP 2.5-10 <b>444 120</b> 100
AD1 <b>467 919</b> 100	AD 1 <b>467 919</b> 100
UK 2.5/2 <b>474 122</b> 25	UK 4/2 <b>474 132</b> 25
UK 2.5/3 <b>474 123</b> 20	UK 4/3 <b>474 133</b> 20
UK 2.5/4 <b>474 124</b> 15	UK 4/4 <b>474 134</b> 15
UK 2.5/10 <b>474 129</b> 5	UK 4/10 <b>474 139</b> 5
TF (Ø2) <b>493 020</b> 5	TF (Ø2.3) <b>493 023</b> 5
	TF (Ø4) <b>493 040</b> 5
	TSK 4 (Ø2.3) <b>490 040</b> 5
	TSK 7 (Ø4) <b>490 070</b> 5
	ITK 28 (Ø4) <b>492 010</b> 5
IP 2 S <b>498 130</b> 25	IP 2 S <b>498 130</b> 25
IP 2 <b>498 140</b> 25	IP 2 <b>498 140</b> 25
GE <b>496 119</b> 50	GE <b>496 119</b> 50
GE 2 <b>496 250</b> 25	GE 2 <b>496 250</b> 25



### AVK 6

WIDTH 8 MM  
304 140

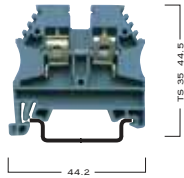

TORQUE: 0.8 NM

### AVK 10

WIDTH 10 MM  
304 150

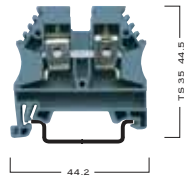

TORQUE: 1.2 NM

### AVK 16

WIDTH 12 MM  
304 160

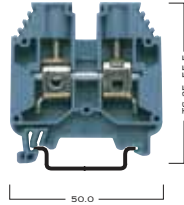

TORQUE: 1.2 NM

### AVK 35

WIDTH 16 MM  
304 170



TORQUE: 2.5 NM

### AVK 70

WIDTH 22 MM  
304 190

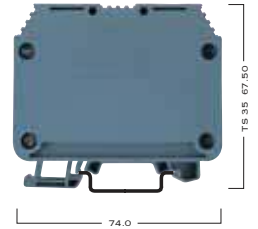

TORQUE: 6 NM

AVK 6			AVK 10			AVK 16			AVK 35			AVK 70		
750V ~ / 44 A / 6 MM <sup>2</sup>			750V ~ / 61 A / 10 MM <sup>2</sup>			750V ~ / 82 A / 16 MM <sup>2</sup>			750V ~ / 135 A / 35 MM <sup>2</sup>			750V ~ / 192 A / 70 MM <sup>2</sup>		
630 V ~ / 41 A / 6 MM <sup>2</sup>			630V ~ / 57 A / 10 MM <sup>2</sup>			750V ~ / 76 A / 16 MM <sup>2</sup>			750V ~ / 125 A / 35 MM <sup>2</sup>					
600V ~ / 50 A / AWG 26-8			600V ~ / 65 A / AWG 16-6			600V ~ / 85 A / AWG 12-4			600V ~ / 115 A / AWG 10-2			600V ~ / 175 A / AWG 6-2/0		
630V ~ / 36 A / 6 MM <sup>2</sup>			500V ~ / 50 A / 10 MM <sup>2</sup>			600V ~ / 66 A / 16 MM <sup>2</sup>			630V ~ / 109 A / 35 MM <sup>2</sup>			1000V ~ / 167 A / 70 MM <sup>2</sup>		
12 MM			12 MM			16 MM			18 MM			20 MM		
0.5 – 10 MM <sup>2</sup>			1.5 – 16 MM <sup>2</sup>			1.5 – 16 MM <sup>2</sup>			6 – 16 MM <sup>2</sup>			10 – 16 MM <sup>2</sup>		
1.5 – 6 MM <sup>2</sup>			1.5 – 10 MM <sup>2</sup>			1.5 – 16 MM <sup>2</sup>			10 – 35 MM <sup>2</sup>			10 – 70 MM <sup>2</sup>		
26 – 8			16 – 6			14 – 4			8 – 1			6 – 2/0		
PART No.	STD. PK.		PART No.	STD. PK.		PART No.	STD. PK.		PART No.	STD. PK.		PART No.	STD. PK.	
<b>304 140</b>	<b>100</b>		<b>304 150</b>	<b>100</b>		<b>304 160</b>	<b>50</b>		<b>304 170</b>	<b>50</b>		<b>304 190</b>	<b>10</b>	
TYPE	PART No.	STD. PK.	TYPE	PART No.	STD. PK.	TYPE	PART No.	STD. PK.	TYPE	PART No.	STD. PK.	TYPE	PART No.	STD. PK.
SLOTTED			SLOTTED			SLOTTED			SLOTTED			SLOTTED		
35x7.5	<b>TS3575SL</b>	2M	35x7.5	<b>TS3575SL</b>	2M	35x7.5	<b>TS3575SL</b>	2M	35x7.5	<b>TS3575SL</b>	2M	35x7.5	<b>TS3575SL</b>	2M
35x7.5	<b>TS3575SL1</b>	1M	35x7.5	<b>TS3575SL1</b>	1M	35x7.5	<b>TS3575SL1</b>	1M	35x7.5	<b>TS3575SL1</b>	1M	35x7.5	<b>TS3575SL1</b>	1M
35x7.5	<b>TS3575SL1-A</b>	1M	35x7.5	<b>TS3575SL1-A</b>	1M	35x7.5	<b>TS3575SL1-A</b>	1M	35x7.5	<b>TS3575SL1-A</b>	1M	35x7.5	<b>TS3575SL1-A</b>	1M
35x15	<b>TS3515SL</b>	2M	35x15	<b>TS3515SL</b>	2M	35x15	<b>TS3515SL</b>	2M	35x15	<b>TS3515SL</b>	2M	35x15	<b>TS3515SL</b>	2M
SOLID			SOLID			SOLID			SOLID			SOLID		
35x7.5	<b>TS3575SOL</b>	2M	35x7.5	<b>TS3575SOL</b>	2M	35x7.5	<b>TS3575SOL</b>	2M	35x7.5	<b>TS3575SOL</b>	2M	35x7.5	<b>TS3575SOL</b>	2M
35x15	<b>TS3515SOL</b>	2M	35x15	<b>TS3515SOL</b>	2M	35x15	<b>TS3515SOL</b>	2M	35x15	<b>TS3515SOL</b>	2M	35x15	<b>TS3515SOL</b>	2M
KD 3	<b>495 049</b>	100	KD 3	<b>495 049</b>	100	KD 3	<b>495 049</b>	100	KD 3	<b>495 049</b>	100	KD 3	<b>495 049</b>	100
NPP 2.5-10	<b>444 120</b>	100	NPP 2.5-10	<b>444 120</b>	100	NPP 16	<b>444 160</b>	100						
AD 1	<b>467 919</b>	100	AD 1	<b>467 919</b>	100									
UK 6/2	<b>474 142</b>	25	UK 10/2	<b>474 152</b>	25	UK 162/2	<b>474 162</b>	25	UK 35/2	<b>474 172</b>	25			
UK 6/3	<b>474 143</b>	20	UK 10/3	<b>474 153</b>	20	UK 16/3	<b>474 163</b>	20	UK 35/3	<b>474 173</b>	20			
UK 6/4	<b>474 144</b>	15	UK 10/4	<b>474 154</b>	15	UK 16/4	<b>474 164</b>	15	UK 35/4	<b>474 174</b>	15			
UK 6/10	<b>474 149</b>	5	UK10/10	<b>474 159</b>	5	UK 16/10	<b>474 169</b>	5	UK 35/10	<b>474 179</b>	5			
TF (Ø2.3)	<b>493 023</b>	5	TF (Ø2.3)	<b>493 023</b>	5	TF (Ø4)	<b>493 040</b>	5	TF (Ø4)	<b>493 040</b>	5			
TF (Ø4)	<b>493 040</b>	5	TF (Ø4)	<b>493 040</b>	5									
TSK 4 (Ø2.3)	<b>490 040</b>	5	TSK 4 (Ø2.3)	<b>490 040</b>	5	TSK 8 (Ø4)	<b>490 080</b>	5	TSK 9 (Ø4)	<b>490 090</b>	5			
TSK 7 (Ø4)	<b>490 070</b>	5	TSK 7 (Ø4)	<b>490 070</b>	5									
ITK 28 (Ø4)	<b>492 010</b>	5	ITK 28 (Ø4)	<b>492 010</b>	5	ITK 32 (Ø4)	<b>492 020</b>	5						
IP 2 S	<b>498 130</b>	25	IP 2 S	<b>498 130</b>	25	IP 2 S	<b>498 130</b>	25	IP 2 S	<b>498 130</b>	25			
IP 2	<b>498 140</b>	25	IP 2	<b>498 140</b>	25	IP 2	<b>498 140</b>	25	IP 2	<b>498 140</b>	25			
GE	<b>496 119</b>	50	GE	<b>496 119</b>	50	GE	<b>496 119</b>	50	GE	<b>496 119</b>	50	GE	<b>496 119</b>	50
GE 2	<b>496 250</b>	25	GE 2	<b>496 250</b>	25	GE 2	<b>496 250</b>	25	GE 2	<b>496 250</b>	25	GE 2	<b>496 250</b>	25



## AVK SERIES

### GROUND TERMINALS

THE STRICT IEC REQUIREMENT IMPOSED ON GROUND CONNECTIONS, SUCH AS LOW CONTACT RESISTANCE, CORROSION-FREE CONNECTION POINTS, SECURED SCREWS, GREEN-YELLOW COLOR CODING AND CLEAR CIRCUIT IDENTIFICATION ARE FULLY OBSERVED BY THE KLEMSAN GROUND TERMINAL BLOCKS

THE STRUCTURAL DESIGN OF THE GROUND TERMINAL BLOCK IS BASED ON MOUNTING RAILS WHEN USED NOT ONLY MECHANICALLY, BUT ALSO ELECTRICALLY. SINCE THESE TERMINAL BLOCKS ARE PROPERLY INSULATED, IT IS POSSIBLE TO POSITION THE GROUND TERMINAL BLOCK DIRECTLY NEXT TO THE CURRENT CARRYING TERMINALS.

WHEN DIN RAILS ARE MOUNTED TO METALLIC CABINETS AND PROPERLY CONNECTED TO EARTH, THE PROPER GROUNDING PROCESS IS COMPLETE.



#### ELECTRICAL RATINGS

VOLTAGE/CURRENT/CROSS-SECTION  
VDE (IEC 60947-7-1)  
VDE (IEC 60947-7-2)  
UL / CSA  
INSULATION STRIPPING LENGTH

#### CONNECTION DATA

SOLID STRAND, SCREW CONNECTION  
FINE STRAND, SCREW CONNECTION  
AWG CONDUCTOR

#### ORDERING DATA

POLYAMIDE 6.6 YELLOW-GREEN

#### MOUNTING RAILS

TS 35x7.5 SOLID TS 35x15 SOLID  
TS 35x7.5 SLOTTED TS 35x15 SLOTTED



STEEL SLOT DIM.  
25MM ON 36MM CENTER  
5.2MM SLOT WIDTH



ALUMINUM SLOT DIM.  
13MM ON 26MM CENTER  
5MM SLOT WIDTH

#### END BRACKET

THICKNESS 8MM GREY



#### GROUP MARKING

GE GREY



#### MARKING TAGS

SEE PAGE 34 FOR FURTHER DETAIL.

**AVK 2.5 / 4 T**

WIDTH 6 MM  
334 120

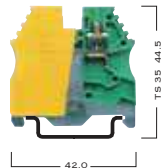

TORQUE: 0.5 NM

**AVK 6 / 10 T**

WIDTH 10 MM  
334 140

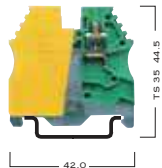

TORQUE: 1.2 NM

**AVK 16 / 35 T**

WIDTH 16 MM  
334 160

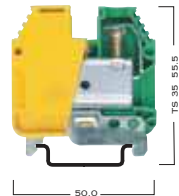

TORQUE: 2.5 NM

-V~ / -A / 4MM <sup>2</sup>			-V~ / -A / 10MM <sup>2</sup>			-V~ / -A / 35MM <sup>2</sup>		
-V~ / -A / 4MM <sup>2</sup>			-V~ / -A / 10MM <sup>2</sup>			-V~ / -A / 35MM <sup>2</sup>		
26 – 10			16 – 8			10 – 2		
10 MM			12 MM			18 MM		
0.5 – 6 MM <sup>2</sup>			1.5 – 16 MM <sup>2</sup>			6 – 16 MM <sup>2</sup>		
1.5 – 4 MM <sup>2</sup>			1.5 – 10 MM <sup>2</sup>			10 – 35 MM <sup>2</sup>		
26 – 10			16 – 6			8 – 1		
PART No.	STD. PK.		PART No.	STD. PK.		PART No.	STD. PK.	
<b>334 120</b>	<b>50</b>		<b>334 140</b>	<b>25</b>		<b>334 160</b>	<b>25</b>	
TYPE	PART No.	STD. PK.	TYPE	PART No.	STD. PK.	TYPE	PART No.	STD. PK.
SLOTTED			SLOTTED			SLOTTED		
35x7.5	<b>TS3575SL</b>	2M	35x7.5	<b>TS3575SL</b>	2M	35x7.5	<b>TS3575SL</b>	2M
35x7.5	<b>TS3575SL1</b>	1M	35x7.5	<b>TS3575SL1</b>	1M	35x7.5	<b>TS3575SL1</b>	1M
35x7.5	<b>TS3575SL1-A</b>	1M	35x7.5	<b>TS3575SL1-A</b>	1M	35x7.5	<b>TS3575SL1-A</b>	1M
35x15	<b>TS3515SL</b>	2M	35x15	<b>TS3515SL</b>	2M	35x15	<b>TS3515SL</b>	2M
SOLID			SOLID			SOLID		
35x7.5	<b>TS3575SOL</b>	2M	35x7.5	<b>TS3575SOL</b>	2M	35x7.5	<b>TS3575SOL</b>	2M
35x15	<b>TS3515SOL</b>	2M	35x15	<b>TS3515SOL</b>	2M	35x15	<b>TS3515SOL</b>	2M
KD 3	<b>495 049</b>	100	KD 3	<b>495 049</b>	100	KD 3	<b>495 049</b>	100
GE	<b>496 119</b>	50	GE	<b>496 119</b>	50	GE	<b>496 119</b>	50



# PEK SERIES

## FEED-THROUGH TERMINALS AND ACCESSORIES

### PEK 2.5 K

WIDTH 5 MM  
305 110

### PEK 2.5

WIDTH 6 MM  
305 120

PEK TYPE TERMINALS ARE MANUFACTURED FROM A THERMOPLASTIC MATERIAL AND ARE MOUNTABLE ON TS35 AND TS32 DIN RAILS. NINE DIFFERENT COLORS GIVE USERS THE ABILITY TO GROUP CONTROL SYSTEMS, CURRENT AND/OR VOLTAGE LEVELS.

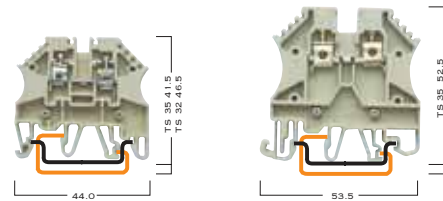

COLORS	TERMINALS	END PLATE	PARTITION
	PART NUMBER	PART NUMBER	PART NUMBER
	<b>PEK 2.5 K</b>	<b>NPP</b>	<b>APP</b>
BEIGE	305 110	445 110	463 110
BLUE	305 111	445 111	463 111
GREEN	305 112	445 112	463 112
YELLOW	305 113	445 113	463 113
RED	305 114	445 114	463 114
BLACK	305 115	445 115	463 115
WHITE	305 116	445 116	463 116
ORANGE	305 117	445 117	463 117
BROWN	305 118	445 118	463 118
	<b>PEK 2.5</b>	<b>NPP</b>	<b>APP</b>
BEIGE	305 120	445 150	463 150
BLUE	305 121	445 151	463 151
GREEN	305 122	445 152	463 152
YELLOW	305 123	445 153	463 153
RED	305 124	445 154	463 154
BLACK	305 125	445 155	463 155
WHITE	305 126	445 156	463 156
ORANGE	305 127	445 157	463 157
BROWN	305 128	445 158	463 158
	<b>PEK 4</b>	<b>NPP</b>	<b>APP</b>
BEIGE	305 130	445 150	463 150
BLUE	305 131	445 151	463 151
GREEN	305 132	445 152	463 152
YELLOW	305 133	445 153	463 153
RED	305 134	445 154	463 154
BLACK	305 135	445 155	463 155
WHITE	305 136	445 156	463 156
ORANGE	305 137	445 157	463 157
BROWN	305 138	445 158	463 158
	<b>PEK 6</b>	<b>NPP</b>	<b>APP</b>
BEIGE	305 140	445 150	463 150
BLUE	305 141	445 151	463 151
GREEN	305 142	445 152	463 152
YELLOW	305 143	445 153	463 153
RED	305 144	445 154	463 154
BLACK	305 145	445 155	463 155
WHITE	305 146	445 156	463 156
ORANGE	305 147	445 157	463 157
BROWN	305 148	445 158	463 158
	<b>PEK 10</b>	<b>NPP</b>	<b>APP</b>
BEIGE	305 150	445 150	463 150
BLUE	305 151	445 151	463 151
GREEN	305 152	445 152	463 152
YELLOW	305 153	445 153	463 153
RED	305 154	445 154	463 154
BLACK	305 155	445 155	463 155
WHITE	305 156	445 156	463 156
ORANGE	305 157	445 157	463 157
BROWN	305 158	445 158	463 158
	<b>PEK 16</b>	<b>NPP</b>	<b>APP</b>
BEIGE	305 160	445 170	463 170
BLUE	305 161	445 171	463 171
GREEN	305 162	445 172	463 172
YELLOW	305 163	445 173	463 173
RED	305 164	445 174	463 174
BLACK	305 165	445 175	463 175
WHITE	305 166	445 176	463 176
ORANGE	305 167	445 177	463 177
BROWN	305 168	445 178	463 178
	<b>PEK 35</b>	<b>NPP</b>	<b>APP</b>
BEIGE	305 170	445 170	463 170
BLUE	305 171	445 171	463 171
GREEN	305 172	445 172	463 172
YELLOW	305 173	445 173	463 173
RED	305 174	445 174	463 174
BLACK	305 175	445 175	463 175
WHITE	305 176	445 176	463 176
ORANGE	305 177	445 177	463 177
BROWN	305 178	445 178	463 178
	<b>PEK 35 I</b>	<b>NPP</b>	<b>APP</b>
BEIGE	305 180	445 170	463 170
BLUE	305 181	445 171	463 171
GREEN	305 182	445 172	463 172
YELLOW	305 183	445 173	463 173
RED	305 184	445 174	463 174
BLACK	305 185	445 175	463 175
WHITE	305 186	445 176	463 176
ORANGE	305 187	445 177	463 177
BROWN	305 188	445 178	463 178

### ELECTRICAL RATINGS

VOLTAGE/CURRENT/CROSS-SECTION  
VDE (IEC 60947-7-1)  
UL

INSULATION STRIPPING LENGTH

### CONNECTION DATA

SOLID STRAND, SCREW CONNECTION  
FINE STRAND, SCREW CONNECTION  
AWG CONDUCTOR

### ORDERING DATA

POLYAMIDE 6.6 BEIGE

### MOUNTING RAILS

TS 35X7.5 SOLID TS 35X15 SOLID  
TS 35X7.5 SLOTTED TS 35X15 SLOTTED



### END BRACKET

THICKNESS 8MM BEIGE  
KD 3

### END PLATE - PARTITION

THICKNESS 1.5MM BEIGE  
POLYAMIDE 6.6 BEIGE  
NPP APP

### SMALL PARTITION

BEIGE  
AD 1

### CROSS CONNECTION

UK 2.5/2 475 112 25 UK 2.5/2 475 122 25  
UK 2.5/3 475 113 20 UK 2.5/3 475 123 20  
UK 2.5/4 475 114 15 UK 2.5/4 475 124 15  
UK 2.5/10 475 119 5 UK 2.5/10 475 129 5

### SWITCHABLE CROSS CONNECTION LINKS



### TEST PLUG-Soc. / INS. TEST Soc.

TF (Ø2) 493 020 5 TF (Ø2) 493 020 5  
TF(Ø2.3) 493 023 5 TF(Ø2.3) 493 023 5  
TSK 1 (Ø2) 490 010 5 TSK 2 (Ø2) 490 020 5  
TSK 3 (Ø2.3) 490 030 5 TSK 4 (Ø2.3) 490 040 5  
ITK 28 (Ø4) 492 010 5

### WARNING LABEL

IP WITH SYMBOL IP 1 S 498 110 25 IP 2 S 498 130 25  
WITHOUT SYMBOL IP 1 498 120 25 IP 2 498 140 25

### GROUP MARKING

GE 496 110 50 GE 1 496 210 25 GE 2 496 250 25  
MGE 1 496 260 25 MGE 1 496 260 25

### MARKING TAGS

SEE PAGE 34 FOR FURTHER DETAIL.

**PEK 4**

WIDTH 6.5 MM  
305 130

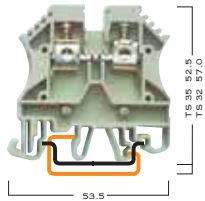

**PEK 6**

WIDTH 8 MM  
305 140

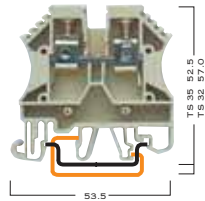

**PEK 10**

WIDTH 10 MM  
305 150

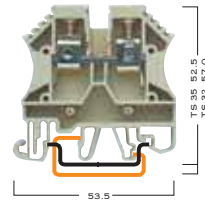

**PEK 16**

WIDTH 12 MM  
305 160

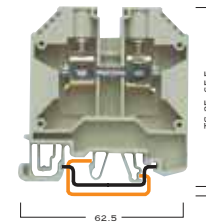

**PEK 35**

WIDTH 16 MM  
305 170

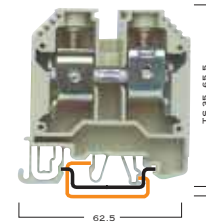

**PEK 35 I**

WIDTH 16 MM  
305 180

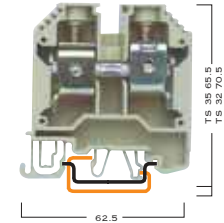

750 V~/34 A/4 MM <sup>2</sup>	750 V~/44 A/6 MM <sup>2</sup>	750 V~/61 A/10 MM <sup>2</sup>	750 V~/82 A/16 MM <sup>2</sup>	750 V~/135 A/35 MM <sup>2</sup>	750 V~/135 A/35 MM <sup>2</sup>
750 V~/32 A/4 MM <sup>2</sup>	750 V~/41 A/6 MM <sup>2</sup>	750 V~/57 A/10 MM <sup>2</sup>	750 V~/76 A/16 MM <sup>2</sup>	750 V~/125 A/35 MM <sup>2</sup>	750 V~/125 A/35 MM <sup>2</sup>
600 V~/34 A/AWG 26-10	600 V~/44 A/AWG 26-8	600 V~/50 A/AWG 16-8	600 V~/65 A/AWG 14-6	600 V~/115 A/AWG 10-2	600 V~/115 A/AWG 10-2
10 MM	12 MM	12 MM	16 MM	18 MM	18 MM
0.5 - 6 MM <sup>2</sup>	0.5 - 10 MM <sup>2</sup>	1.5 - 16 MM <sup>2</sup>	1.5 - 16 MM <sup>2</sup>	6 - 16 MM <sup>2</sup>	6 - 16 MM <sup>2</sup>
1.5 - 4 MM <sup>2</sup>	1.5 - 6 MM <sup>2</sup>	1.5 - 10 MM <sup>2</sup>	1.5 - 16 MM <sup>2</sup>	6 - 35 MM <sup>2</sup>	6 - 35 MM <sup>2</sup>
26 - 10	26 - 8	16 - 6	14 - 4	10 - 1	10 - 1
PART No.    STD. PK.	PART No.    STD. PK.	PART No.    STD. PK.	PART No.    STD. PK.	PART No.    STD. PK.	PART No.    STD. PK.
<b>305 130        100</b>	<b>305 140        100</b>	<b>305 150        100</b>	<b>305 160        50</b>	<b>305 170        50</b>	<b>305 180        30</b>
TYPE    PART No. STD.PK.	TYPE    PART No. STD.PK.	TYPE    PART No. STD.PK.	TYPE    PART No. STD.PK.	TYPE    PART No. STD.PK.	TYPE    PART No. STD.PK.
SLOTTED	SLOTTED	SLOTTED	SLOTTED	SLOTTED	SLOTTED
35x7.5 <b>TS3575SL</b> 2M	35x7.5 <b>TS3575SL</b> 2M	35x7.5 <b>TS3575SL</b> 2M	35x7.5 <b>TS3575SL</b> 2M	35x7.5 <b>TS3575SL</b> 2M	35x7.5 <b>TS3575SL</b> 2M
35x7.5 <b>TS3575SL1</b> 1M	35x7.5 <b>TS3575SL1</b> 1M	35x7.5 <b>TS3575SL1</b> 1M	35x7.5 <b>TS3575SL1</b> 1M	35x7.5 <b>TS3575SL1</b> 1M	35x7.5 <b>TS3575SL1</b> 1M
35x7.5 <b>TS3575SL1-A</b> 1M	35x7.5 <b>TS3575SL1-A</b> 1M	35x7.5 <b>TS3575SL1-A</b> 1M	35x7.5 <b>TS3575SL1-A</b> 1M	35x7.5 <b>TS3575SL1-A</b> 1M	35x7.5 <b>TS3575SL1-A</b> 1M
35x15 <b>TS3515SL</b> 2M	35x15 <b>TS3515SL</b> 2M	35x15 <b>TS3515SL</b> 2M	35x15 <b>TS3515SL</b> 2M	35x15 <b>TS3515SL</b> 2M	35x15 <b>TS3515SL</b> 2M
SOLID	SOLID	SOLID	SOLID	SOLID	SOLID
35x7.5 <b>TS3575SOL</b> 2M	35x7.5 <b>TS3575SOL</b> 2M	35x7.5 <b>TS3575SOL</b> 2M	35x7.5 <b>TS3575SOL</b> 2M	35x7.5 <b>TS3575SOL</b> 2M	35x7.5 <b>TS3575SOL</b> 2M
35x15 <b>TS3515SOL</b> 2M	35x15 <b>TS3515SOL</b> 2M	35x15 <b>TS3515SOL</b> 2M	35x15 <b>TS3515SOL</b> 2M	35x15 <b>TS3515SOL</b> 2M	35x15 <b>TS3515SOL</b> 2M
KD 3 <b>495 040</b> 100	KD 3 <b>495 040</b> 100	KD 3 <b>495 040</b> 100	KD 3 <b>495 040</b> 100	KD 3 <b>495 040</b> 100	KD 3 <b>495 040</b> 100
NPP2.5-10 <b>445 150</b> 100	NPP2.5-10 <b>445 150</b> 100	NPP2.5-10 <b>445 150</b> 100	NPP 16-35 <b>445 170</b> 25	NPP 16-35 <b>445 170</b> 25	NPP 16-35 <b>445 170</b> 25
APP2.5-10 <b>463 150</b> 25	APP2.5-10 <b>463 150</b> 25	APP2.5-10 <b>463 150</b> 25	APP 16-35 <b>463 170</b> 25	APP 16-35 <b>463 170</b> 25	APP 16-35 <b>463 170</b> 25
AD 2 <b>467 950</b> 100	AD 2 <b>467 950</b> 100	AD 2 <b>467 950</b> 100			
UK 4/2 <b>475 132</b> 25	UK 6/2 <b>475 142</b> 25	UK 10/2 <b>475 152</b> 25	UK 16/2 <b>475 162</b> 25	UK 35/2 <b>475 172</b> 25	UK 35/2 <b>475 172</b> 25
UK 4/3 <b>475 133</b> 20	UK 6/3 <b>475 143</b> 20	UK 10/3 <b>475 153</b> 20	UK 16/3 <b>475 163</b> 20	UK 35/3 <b>475 173</b> 20	UK 35/3 <b>475 173</b> 20
UK 4/4 <b>475 134</b> 15	UK 6/4 <b>475 144</b> 15	UK 10/4 <b>475 154</b> 15	UK 16/4 <b>475 164</b> 15	UK 35/4 <b>475 174</b> 15	UK 35/4 <b>475 174</b> 15
UK 4/10 <b>475 139</b> 5	UK 6/10 <b>475 149</b> 5	UK 10/10 <b>475 159</b> 5	UK 16/10 <b>475 169</b> 5	UK 35/10 <b>475 179</b> 5	UK 35/10 <b>475 179</b> 5
CK 4 <b>485 204</b> 25	CK 6 <b>485 206</b> 25	CK 10 <b>485 210</b> 25	CK 16 <b>485 216</b> 10	CK 16 <b>485 235</b> 10	CK 16 <b>485 235</b> 10
TF(Ø2.3) <b>493 023</b> 5	TF(Ø2.3) <b>493 023</b> 5	TF(Ø2.3) <b>493 023</b> 5	TF(Ø4) <b>493 040</b> 5	TF(Ø4) <b>493 040</b> 5	TF(Ø4) <b>493 040</b> 5
TF(Ø4) <b>493 040</b> 5	TF(Ø4) <b>493 040</b> 5	TF(Ø4) <b>493 040</b> 5			
TSK4(Ø2.3) <b>490 040</b> 5	TSK4(Ø2.3) <b>490 040</b> 5	TSK4(Ø2.3) <b>490 040</b> 5	TSK8(Ø4) <b>490 080</b> 5	TSK9(Ø4) <b>490 090</b> 5	TSK9(Ø4) <b>490 090</b> 5
TSK7(Ø4) <b>490 070</b> 5	TSK7(Ø4) <b>490 070</b> 5	TSK7(Ø4) <b>490 070</b> 5			
ITK 28((Ø4)) <b>492 010</b> 5	ITK 28((Ø4)) <b>492 010</b> 5	ITK 28((Ø4)) <b>492 010</b> 5	ITK 32(Ø4) <b>492 020</b> 5		
IP 2 S <b>498 130</b> 25	IP 2 S <b>498 130</b> 25	IP 2 S <b>498 130</b> 25	IP 3 S <b>498 143</b> 25	IP 3 S <b>498 143</b> 25	IP 3 S <b>498 143</b> 25
IP 2 <b>498 140</b> 25	IP 2 <b>498 140</b> 25	IP 2 <b>498 140</b> 25	IP 3 <b>498 145</b> 25	IP 3 <b>498 145</b> 25	IP 3 <b>498 145</b> 25
GE <b>496 110</b> 50	GE <b>496 110</b> 50	GE <b>496 110</b> 50	GE <b>496 110</b> 50	GE <b>496 110</b> 50	GE <b>496 110</b> 50
GE 2 <b>496 250</b> 25	GE 2 <b>496 250</b> 25	GE 2 <b>496 250</b> 25	GE 3 <b>496 255</b> 10	GE 3 <b>496 255</b> 10	GE 3 <b>496 255</b> 10
MGE 1 <b>496 260</b> 25	MGE 1 <b>496 260</b> 25	MGE 1 <b>496 260</b> 25	MGE 1 <b>496 260</b> 25	MGE 1 <b>496 260</b> 25	MGE 1 <b>496 260</b> 25



## WGT SERIES

### GROUND TERMINALS

WGT SERIES GROUND TERMINALS CAN BE USED ON BOTH TS35 AND TS32 DIN RAILS. THE YELLOW/GREEN COLOR COMBINATION MEETS INTERNATIONAL STANDARDS FOR GROUND LABELING. THE INTERNAL METAL PARTS ELECTRICALLY CONNECT THE FIELD WIRING TO THE DIN RAIL. DIN RAILS MOUNTED TO METALLIC CABINETY AND CONNECTED TO EARTH, COMPLETE THE PROPER GROUNDING PROCESS.



#### ELECTRICAL RATINGS

VOLTAGE/CURRENT/CROSS-SECTION  
VDE (IEC 60947-7-2)  
UL

INSULATION STRIPPING LENGTH

#### CONNECTION DATA

SOLID STRAND, SCREW CONNECTION  
FINE STRAND, SCREW CONNECTION  
AWG CONDUCTOR

#### ORDERING DATA

POLYAMIDE 6.6

YELLOW-GREEN

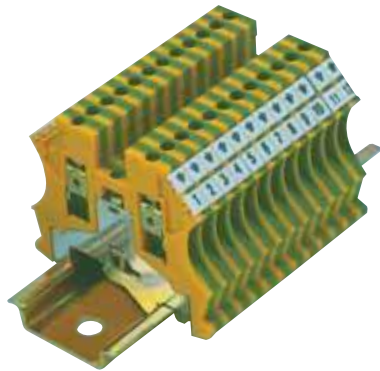

#### MOUNTING RAILS

TS 35x7.5 SOLID  
TS 35x7.5 SLOTTED

TS 35x15 SOLID  
TS 35x15 SLOTTED



STEEL SLOT DIM.  
25MM ON 36MM CENTER  
5.2MM SLOT WIDTH



ALUMINUM SLOT DIM.  
13MM ON 26MM CENTER  
5MM SLOT WIDTH

THICKNESS 8MM

KD 3



BEIGE

#### MARKING TAGS

SEE PAGE 34 FOR FURTHER DETAIL.

**WGT 2.5**

WIDTH 5 MM  
331 120

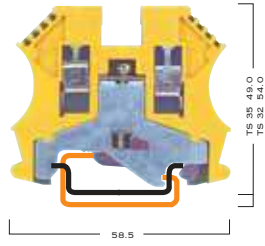

**WGT 4**

WIDTH 6 MM  
331 130

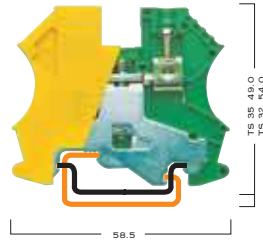

**WGT 6**

WIDTH 8 MM  
331 140

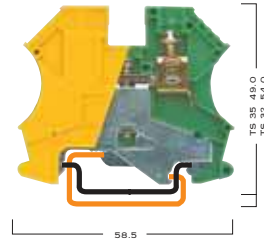

**WGT 10**

WIDTH 10 MM  
331 150

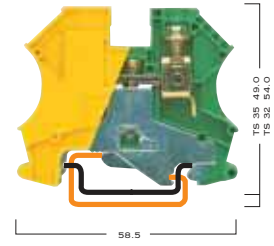

- V~ / - A / 2.5 MM <sup>2</sup>	- V~ / - A / 4 MM <sup>2</sup>	- V~ / - A / 6 MM <sup>2</sup>	- V~ / - A / 10 MM <sup>2</sup>
- V~ / - A / 2.5 MM <sup>2</sup>	- V~ / - A / 4 MM <sup>2</sup>	- V~ / - A / 6 MM <sup>2</sup>	- V~ / - A / 10 MM <sup>2</sup>
- V~ / - A / AWG 26-12	- V~ / - A / AWG 26-12	- V~ / - A / AWG 26-8	- V~ / - A / AWG 16-8
12 MM	12 MM	12 MM	12 MM
0.5 - 4 MM <sup>2</sup>	0.5 - 6 MM <sup>2</sup>	0.5 - 10 MM <sup>2</sup>	0.5 - 16 MM <sup>2</sup>
1.5 - 2.5 MM <sup>2</sup>	1.5 - 4 MM <sup>2</sup>	1.5 - 6 MM <sup>2</sup>	1.5 - 10 MM <sup>2</sup>
26 - 12	26 - 10	20 - 8	16 - 6
PART No.                      STD. PK.	PART No.                      STD. PK.	PART No.                      STD. PK.	PART No.                      STD. PK.
<b>331 120                              50</b>	<b>331 130                              50</b>	<b>331 140                              40</b>	<b>331 150                              30</b>

TYPE	PART No.	STD. PK.	TYPE	PART No.	STD. PK.	TYPE	PART No.	STD. PK.	TYPE	PART No.	STD. PK.
SLOTTED			SLOTTED			SLOTTED			SLOTTED		
35x7.5	<b>TS3575SL</b>	2M	35x7.5	<b>TS3575SL</b>	2M	35x7.5	<b>TS3575SL</b>	2M	35x7.5	<b>TS3575SL</b>	2M
35x7.5	<b>TS3575SL1</b>	1M	35x7.5	<b>TS3575SL1</b>	1M	35x7.5	<b>TS3575SL1</b>	1M	35x7.5	<b>TS3575SL1</b>	1M
35x7.5	<b>TS3575SL1-A</b>	1M	35x7.5	<b>TS3575SL1-A</b>	1M	35x7.5	<b>TS3575SL1-A</b>	1M	35x7.5	<b>TS3575SL1-A</b>	1M
35x15	<b>TS3515SL</b>	2M	35x15	<b>TS3515SL</b>	2M	35x15	<b>TS3515SL</b>	2M	35x15	<b>TS3515SL</b>	2M
SOLID			SOLID			SOLID			SOLID		
35x7.5	<b>TS3575SOL</b>	2M	35x7.5	<b>TS3575SOL</b>	2M	35x7.5	<b>TS3575SOL</b>	2M	35x7.5	<b>TS3575SOL</b>	2M
35x15	<b>TS3515SOL</b>	2M	35x15	<b>TS3515SOL</b>	2M	35x15	<b>TS3515SOL</b>	2M	35x15	<b>TS3515SOL</b>	2M
KD 3	<b>495 040</b>	100	KD 3	<b>495 040</b>	100	KD 3	<b>495 040</b>	100	KD 3	<b>495 040</b>	100



## YBK SERIES

### TENSION CLAMP TERMINALS

TENSION CLAMP TERMINALS PROVIDE A FASTER METHOD OF TERMINATING WIRES AS COMPARED TO SCREW CLAMP SYSTEMS. APPROVED BY UL, THEY ARE JUST AS RELIABLE IN FIELD APPLICATIONS.

THE TENSION CLAMP IS OPENED WITH A SMALL SCREWDRIVER INSERTED TO THE SIDE OF THE CLAMP NEXT TO THE WIRE ENTRY WAY. WHEN THE FIELD WIRING IS IN PLACE, THE SCREWDRIVER CAN BE REMOVED AND A RELIABLE, SECURE CONNECTION IS MAINTAINED.



#### ELECTRICAL RATINGS

VOLTAGE/CURRENT/CROSS-SECTION  
UL

INSULATION STRIPPING LENGTH

#### CONNECTION DATA

SOLID STRAND, CLAMP CONNECTION  
FINE STRAND, CLAMP CONNECTION  
AWG CONDUCTOR

#### ORDERING DATA

POLYAMIDE 6.6 BEIGE  
GREY

COLORS	TERMINALS		END PLATE
	PART NUMBER	PART NUMBER	
	<b>YBK 2.5</b>	<b>NPP</b>	
BEIGE	306 220	446 320	
BLUE	306 221	446 321	
GREEN	306 222	446 322	
YELLOW	306 223	446 323	
RED	306 224	446 324	
GREY	306 229	446 329	
	<b>YBK 4</b>	<b>NPP</b>	
BEIGE	306 230	446 330	
BLUE	306 231	446 331	
GREEN	306 232	446 332	
YELLOW	306 233	446 333	
RED	306 234	446 334	
GREY	306 239	446 339	
	<b>YBK 6</b>	<b>NPP</b>	
BEIGE	306 240	446 340	
BLUE	306 241	446 341	
GREEN	306 242	446 342	
YELLOW	306 243	446 343	
RED	306 244	446 344	
GREY	306 249	446 349	
	<b>YBK 10</b>	<b>NPP</b>	
BEIGE	306 250	446 350	
BLUE	306 251	446 351	
GREEN	306 252	446 352	
YELLOW	306 253	446 353	
RED	306 254	446 354	
GREY	306 259	446 359	

#### MOUNTING RAILS

TS 35X7.5 SOLID TS 35X15 SOLID  
TS 35X7.5 SLOTTED TS 35X15 SLOTTED



STEEL SLOT DIM.  
25MM ON 36MM CENTER  
5.2MM SLOT WIDTH



ALUMINUM SLOT DIM.  
13MM ON 26MM CENTER  
5MM SLOT WIDTH

#### END BRACKET

THICKNESS 8MM

KD 3



BEIGE  
GREY

#### END PLATE

THICKNESS 1.2MM  
POLYAMIDE 6.6

NPP



BEIGE  
GREY

#### CROSS CONNECTION



#### TEST PLUG

TF



#### WARNING LABEL

IP



WITH SYMBOL  
WITHOUT SYMBOL

#### GROUP MARKING

GE



BEIGE  
GREY

#### MARKING TAGS

SEE PAGE 34 FOR FURTHER DETAIL.

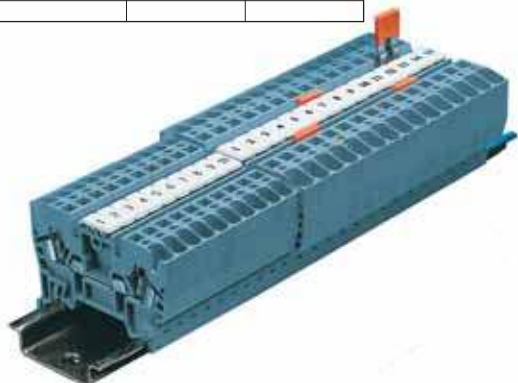



### YBK 2.5

WIDTH 5 MM  
306 220 BEIGE  
306 229 GREY

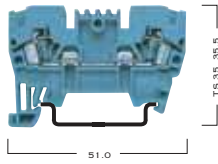

### YBK 4

WIDTH 6 MM  
306 230 BEIGE  
306 239 GREY

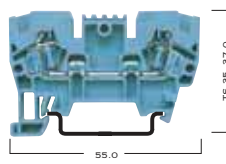

### YBK 6

WIDTH 8 MM  
306 240 BEIGE  
306 249 GRAU / GREY

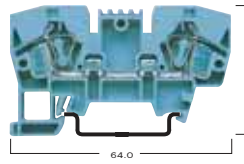

### YBK 10

WIDTH 10 MM  
306 250 BEIGE  
306 259 GREY

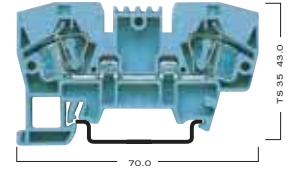

YBK 2.5			YBK 4			YBK 6			YBK 10		
750 V~ / 22 A / 2.5 MM <sup>2</sup>			750 V~ / 30 A / 4 MM <sup>2</sup>			750 V~ / 40 A / 6 MM <sup>2</sup>			750 V~ / 63 A / 10 MM <sup>2</sup>		
600 V~ / 20 A / AWG 22-12			600 V~ / 26 A / AWG 22-10			600 V~ / 35 A / AWG 22-8			600 V~ / 55 A / AWG 20-6		
10 MM			12 MM			13 MM			13 MM		
0.5 - 2.5 MM <sup>2</sup>			0.5 - 4 MM <sup>2</sup>			0.5 - 6 MM <sup>2</sup>			0.5 - 10 MM <sup>2</sup>		
0.5 - 2.5 MM <sup>2</sup>			0.5 - 4 MM <sup>2</sup>			0.5 - 6 MM <sup>2</sup>			0.5 - 10 MM <sup>2</sup>		
22 - 12			22 - 10			22 - 8			20 - 6		
PART NO.	STD. PK.		PART NO.	STD. PK.		PART NO.	STD. PK.		PART NO.	STD. PK.	
<b>306 220</b>	<b>100</b>		<b>306 230</b>	<b>100</b>		<b>306 240</b>	<b>100</b>		<b>306 250</b>	<b>100</b>	
<b>306 229</b>	<b>100</b>		<b>306 239</b>	<b>100</b>		<b>306 249</b>	<b>100</b>		<b>306 259</b>	<b>100</b>	
TYPE	PART No.	STD. PK.	TYPE	PART No.	STD. PK.	TYPE	PART No.	STD. PK.	TYPE	PART No.	STD. PK.
SLOTTED			SLOTTED			SLOTTED			SLOTTED		
35x7.5	<b>TS3575SL</b>	2M	35x7.5	<b>TS3575SL</b>	2M	35x7.5	<b>TS3575SL</b>	2M	35x7.5	<b>TS3575SL</b>	2M
35x7.5	<b>TS3575SL1</b>	1M	35x7.5	<b>TS3575SL1</b>	1M	35x7.5	<b>TS3575SL1</b>	1M	35x7.5	<b>TS3575SL1</b>	1M
35x7.5	<b>TS3575SL1-A</b>	1M	35x7.5	<b>TS3575SL1-A</b>	1M	35x7.5	<b>TS3575SL1-A</b>	1M	35x7.5	<b>TS3575SL1-A</b>	1M
35x15	<b>TS3515SL</b>	2M	35x15	<b>TS3515SL</b>	2M	35x15	<b>TS3515SL</b>	2M	35x15	<b>TS3515SL</b>	2M
SOLID			SOLID			SOLID			SOLID		
35x7.5	<b>TS3575SOL</b>	2M	35x7.5	<b>TS3575SOL</b>	2M	35x7.5	<b>TS3575SOL</b>	2M	35x7.5	<b>TS3575SOL</b>	2M
35x15	<b>TS3515SOL</b>	2M	35x15	<b>TS3515SOL</b>	2M	35x15	<b>TS3515SOL</b>	2M	35x15	<b>TS3515SOL</b>	2M
KD 3	<b>495 040</b>	100	KD 3	<b>495 040</b>	100	KD 3	<b>495 040</b>	100	KD 3	<b>495 040</b>	100
KD 3	<b>495 049</b>	100	KD 3	<b>495 049</b>	100	KD 3	<b>495 049</b>	100	KD 3	<b>495 049</b>	100
NPP	<b>446 320</b>	100	NPP	<b>446 330</b>	100	NPP	<b>446 340</b>	100	NPP	<b>446 350</b>	100
NPP	<b>446 329</b>	100	NPP	<b>446 339</b>	100	NPP	<b>446 349</b>	100	NPP	<b>446 359</b>	100
UK 2.5/2	<b>476 222</b>	25	UK 4/2	<b>476 232</b>	25	UK 6/2	<b>476 242</b>	25	UK 10/2	<b>476 252</b>	25
UK 2.5/3	<b>476 223</b>	20	UK 4/3	<b>476 233</b>	20	UK 6/3	<b>476 243</b>	20	UK 10/3	<b>476 253</b>	20
UK 2.5/4	<b>476 224</b>	15	UK 4/4	<b>476 234</b>	15	UK 6/4	<b>476 244</b>	15	UK 10/4	<b>476 254</b>	15
UK 2.5/10	<b>476 229</b>	5	UK 4/10	<b>476 239</b>	5	UK 6/10	<b>476 249</b>	5			
TF (Ø2)	<b>493 020</b>	5	TF (Ø2)	<b>493 020</b>	5	TF (Ø2)	<b>493 020</b>	5	TF (Ø2)	<b>493 020</b>	5
IP 4 S	<b>498 160</b>	25	IP 4 S	<b>498 160</b>	25	IP 4 S	<b>498 160</b>	25	IP 4 S	<b>498 160</b>	25
IP 4	<b>498 170</b>	25	IP 4	<b>498 170</b>	25	IP 4	<b>498 170</b>	25	IP 4	<b>498 170</b>	25
GE	<b>496 110</b>	50	GE	<b>496 110</b>	50	GE	<b>496 110</b>	50	GE	<b>496 110</b>	50
GE	<b>496 119</b>	50	GE	<b>496 119</b>	50	GE	<b>496 119</b>	50	GE	<b>496 119</b>	50



## YBK SERIES

### TENSION CLAMP GROUND TERMINALS

THE YBK TENSION CLAMP GROUND TERMINAL BLOCKS ELECTRICALLY CONNECT FIELD WIRING TO THE DIN RAIL VIA THE METALLIC INTERNAL PARTS. WHEN THE DIN RAIL IS CONNECTED TO METALLIC CABINETRY THAT IS SECURED TO EARTH, THE PROPER GROUNDING PROCESS IS COMPLETED.



#### ELECTRICAL RATINGS

VOLTAGE/CURRENT/CROSS-SECTION  
UL

INSULATION STRIPPING LENGTH

#### CONNECTION DATA

SOLID STRAND, CLAMP CONNECTION  
FINE STRAND, CLAMP CONNECTION  
AWG CONDUCTOR

#### ORDERING DATA

POLYAMIDE 6.6 YELLOW-GREEN

#### MOUNTING RAILS

TS 35x7.5 SOLID TS 35x15 SOLID  
TS 35x7.5 SLOTTED TS 35x15 SLOTTED



STEEL SLOT DIM.  
25MM ON 36MM CENTER  
5.2MM SLOT WIDTH



ALUMINUM SLOT DIM.  
13MM ON 26MM CENTER  
5MM SLOT WIDTH

#### END BRACKET

THICKNESS 8MM

KD 3



BEIGE  
GREY

#### END PLATE

THICKNESS 1.2MM  
POLYAMIDE 6.6

NPP



GREEN

#### GROUP MARKING

GE



BEIGE  
GREY

#### MARKING TAGS

SEE PAGE 34 FOR FURTHER DETAIL.

**YBK 2.5 T**

WIDTH 5 MM  
336 220

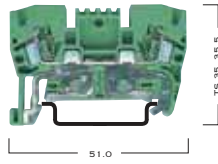

**YBK 4 T**

WIDTH 6 MM  
336 230

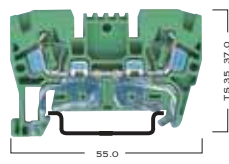

**YBK 6 T**

WIDTH 8 MM  
336 240

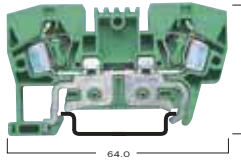

**YBK 10 T**

WIDTH 10 MM  
336 250

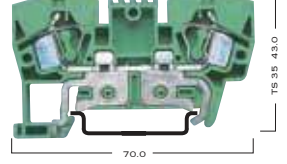

- V~ / - A / 2.5 MM <sup>2</sup>			- V~ / - A / 4 MM <sup>2</sup>			- V~ / - A / 6 MM <sup>2</sup>			- V~ / - A / 10 MM <sup>2</sup>		
600 V~ / 20 A / AWG 22-12			600 V~ / 26 A / AWG 22-10			600 V~ / 35 A / AWG 22-8			600 V~ / 55 A / AWG 20-6		
10 MM			12 MM			13 MM			13 MM		
0.5 - 2.5 MM <sup>2</sup>			0.5 - 4 MM <sup>2</sup>			0.5 - 6 MM <sup>2</sup>			0.5 - 10 MM <sup>2</sup>		
0.5 - 2.5 MM <sup>2</sup>			0.5 - 4 MM <sup>2</sup>			0.5 - 6 MM <sup>2</sup>			0.5 - 10 MM <sup>2</sup>		
22 - 12			22 - 10			22 - 8			20 - 6		
PART No.	STD. PK.		PART No.	STD. PK.		PART No.	STD. PK.		PART No.	STD. PK.	
<b>336 220</b>	<b>50</b>		<b>336 230</b>	<b>50</b>		<b>336 240</b>	<b>40</b>		<b>336 250</b>	<b>30</b>	
TYPE	PART No.	STD. PK.	TYPE	PART No.	STD. PK.	TYPE	PART No.	STD. PK.	TYPE	PART No.	STD. PK.
SLOTTED			SLOTTED			SLOTTED			SLOTTED		
35x7.5	<b>TS3575SL</b>	2M	35x7.5	<b>TS3575SL</b>	2M	35x7.5	<b>TS3575SL</b>	2M	35x7.5	<b>TS3575SL</b>	2M
35x7.5	<b>TS3575SL1</b>	1M	35x7.5	<b>TS3575SL1</b>	1M	35x7.5	<b>TS3575SL1</b>	1M	35x7.5	<b>TS3575SL1</b>	1M
35x7.5	<b>TS3575SL1-A</b>	1M	35x7.5	<b>TS3575SL1-A</b>	1M	35x7.5	<b>TS3575SL1-A</b>	1M	35x7.5	<b>TS3575SL1-A</b>	1M
35x15	<b>TS3515SL</b>	2M	35x15	<b>TS3515SL</b>	2M	35x15	<b>TS3515SL</b>	2M	35x15	<b>TS3515SL</b>	2M
SOLID			SOLID			SOLID			SOLID		
35x7.5	<b>TS3575SOL</b>	2M	35x7.5	<b>TS3575SOL</b>	2M	35x7.5	<b>TS3575SOL</b>	2M	35x7.5	<b>TS3575SOL</b>	2M
35x15	<b>TS3515SOL</b>	2M	35x15	<b>TS3515SOL</b>	2M	35x15	<b>TS3515SOL</b>	2M	35x15	<b>TS3515SOL</b>	2M
KD 3	<b>495 040</b>	100	KD 3	<b>495 040</b>	100	KD 3	<b>495 040</b>	100	KD 3	<b>495 040</b>	100
KD 3	<b>495 049</b>	100	KD 3	<b>495 049</b>	100	KD 3	<b>495 049</b>	100	KD 3	<b>495 049</b>	100
NPP	<b>446 322</b>	100	NPP	<b>446 332</b>	100	NPP	<b>446 342</b>	100	NPP	<b>446 352</b>	100
GE	<b>496 110</b>	50	GE	<b>496 110</b>	50	GE	<b>496 110</b>	50	GE	<b>496 110</b>	50
GE	<b>496 119</b>	50	GE	<b>496 119</b>	50	GE	<b>496 119</b>	50	GE	<b>496 119</b>	50



# YBK SERIES

## YBK 2.5 E

WIDTH 5 MM  
 326 050 BEIGE  
 326 059 GREY

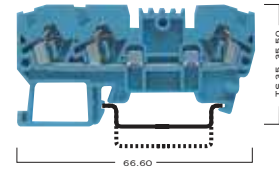

### ELECTRICAL RATINGS

VOLTAGE/CURRENT/CROSS-SECTION

750 V~ / 24 A / 2.5 MM<sup>2</sup>

INSULATION STRIPPING LENGTH

13 MM

### CONNECTION DATA

SOLID STRAND, CLAMP CONNECTION

0.5 - 2.5 MM<sup>2</sup>

FINE STRAND, CLAMP CONNECTION

0.5 - 2.5 MM<sup>2</sup>

AWG CONDUCTOR

22 - 12

### ORDERING DATA

POLYAMIDE 6.6  
 BEIGE  
 GREY  
 YELLOW-GREEN

PART No.	STD. Pk.
<b>326 050</b>	<b>50</b>
<b>326 059</b>	<b>50</b>

### MOUNTING RAILS

TS 35X7.5 SOLID      TS 35X15 SOLID  
 TS 35X7.5 SLOTTED      TS 35X15 SLOTTED

STEEL SLOT DIM.  
 25MM ON 36MM CENTER  
 5.2MM SLOT WIDTH

ALUMINUM SLOT DIM.  
 13MM ON 26MM CENTER  
 5MM SLOT WIDTH

### END BRACKET

THICKNESS 8MM  
 BEIGE  
 GREY



TYPE	PART No.	STD. Pk.
SLOTTED		
35x7.5	<b>TS3575SSL</b>	2M
35x7.5	<b>TS3575SL1</b>	1M
35x7.5	<b>TS3575SL1-A</b>	1M
35x15	<b>TS3515SSL</b>	2M
SOLID		
35x7.5	<b>TS3575SOL</b>	2M
35x15	<b>TS3515SOL</b>	2M

KD 3	<b>495 040</b>	100
KD 3	<b>495 049</b>	100

### END PLATE

THICKNESS 1.2MM  
 POLYAMIDE 6.6  
 NPP  
 BEIGE  
 GREY  
 GREEN



NPP	<b>446 210</b>	10
NPP	<b>446 219</b>	10

### CROSS CONNECTION



UK 2.5/2	<b>476 222</b>	25
UK 2.5/3	<b>476 223</b>	20
UK 2.5/4	<b>476 224</b>	15
UK 2.5/10	<b>476 229</b>	5

### TEST PLUG



TF (Ø2)	<b>493 020</b>	5
---------	----------------	---

### GROUP MARKING



GE	<b>496 110</b>	50
GE	<b>496 119</b>	50

### MARKING TAGS

SEE PAGE 34 FOR FURTHER DETAIL.

**YBK 2.5 C**

WIDTH 5 MM  
326 100 BEIGE  
326 109 GREY

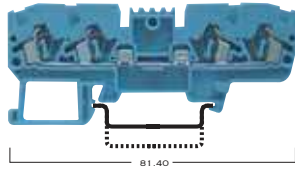

**YBK 2.5 CX2**

WIDTH 5 MM  
326 200 BEIGE  
326 209 GREY

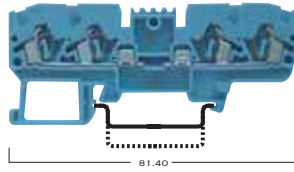

**YBK 2.5 CD**

WIDTH 5 MM  
326 210 BEIGE  
326 219 GREY

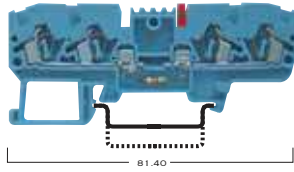

**YBK 2.5 CT**

WIDTH 5 MM  
336 100  
GROUND TERMINAL

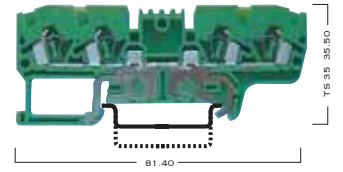

750 V~ / 24 A / 2.5 MM <sup>2</sup>			750 V~ / 24 A / 2.5 MM <sup>2</sup>			750 V~ / 24 A / 2.5 MM <sup>2</sup>			- V~ / - A / 2.5 MM <sup>2</sup>		
13 MM			13 MM			13 MM			13 MM		
0.5 - 2.5 MM <sup>2</sup>			0.5 - 2.5 MM <sup>2</sup>			0.5 - 2.5 MM <sup>2</sup>			0.5 - 2.5 MM <sup>2</sup>		
0.5 - 2.5 MM <sup>2</sup>			0.5 - 2.5 MM <sup>2</sup>			0.5 - 2.5 MM <sup>2</sup>			0.5 - 2.5 MM <sup>2</sup>		
22 - 12			22 - 12			22 - 12			22 - 12		
PART NO.	STD. PK.		PART NO.	STD. PK.		PART NO.	STD. PK.		PART NO.	STD. PK.	
<b>326 100</b>	<b>50</b>		<b>326 200</b>	<b>50</b>		<b>326 210</b>	<b>50</b>				
<b>326 109</b>	<b>50</b>		<b>326 209</b>	<b>50</b>		<b>326 219</b>	<b>50</b>		<b>336 100</b>	<b>50</b>	
TYPE	PART No.	STD. PK.	TYPE	PART No.	STD. PK.	TYPE	PART No.	STD. PK.	TYPE	PART No.	STD. PK.
SLOTTED			SLOTTED			SLOTTED			SLOTTED		
35x7.5	<b>TS3575SL</b>	2M	35x7.5	<b>TS3575SL</b>	2M	35x7.5	<b>TS3575SL</b>	2M	35x7.5	<b>TS3575SL</b>	2M
35x7.5	<b>TS3575SL1</b>	1M	35x7.5	<b>TS3575SL1</b>	1M	35x7.5	<b>TS3575SL1</b>	1M	35x7.5	<b>TS3575SL1</b>	1M
35x7.5	<b>TS3575SL1-A</b>	1M	35x7.5	<b>TS3575SL1-A</b>	1M	35x7.5	<b>TS3575SL1-A</b>	1M	35x7.5	<b>TS3575SL1-A</b>	1M
35x15	<b>TS3515SL</b>	2M	35x15	<b>TS3515SL</b>	2M	35x15	<b>TS3515SL</b>	2M	35x15	<b>TS3515SL</b>	2M
SOLID			SOLID			SOLID			SOLID		
35x7.5	<b>TS3575SOL</b>	2M	35x7.5	<b>TS3575SOL</b>	2M	35x7.5	<b>TS3575SOL</b>	2M	35x7.5	<b>TS3575SOL</b>	2M
35x15	<b>TS3515SOL</b>	2M	35x15	<b>TS3515SOL</b>	2M	35x15	<b>TS3515SOL</b>	2M	35x15	<b>TS3515SOL</b>	2M
KD 3	<b>495 040</b>	100	KD 3	<b>495 040</b>	100	KD 3	<b>495 040</b>	100	KD 3	<b>495 040</b>	100
KD 3	<b>495 049</b>	100	KD 3	<b>495 049</b>	100	KD 3	<b>495 049</b>	100	KD 3	<b>495 049</b>	100
NPP	<b>446 270</b>	10	NPP	<b>446 270</b>	10	NPP	<b>446 270</b>	10			
NPP	<b>446 279</b>	10	NPP	<b>446 279</b>	10	NPP	<b>446 279</b>	10			
									NPP	<b>446 272</b>	10
UK 2.5/2	<b>476 222</b>	25	UK 2.5/2	<b>476 222</b>	25	UK 2.5/2	<b>476 222</b>	25			
UK 2.5/3	<b>476 223</b>	20	UK 2.5/3	<b>476 223</b>	20	UK 2.5/3	<b>476 223</b>	20			
UK 2.5/4	<b>476 224</b>	15	UK 2.5/4	<b>476 224</b>	15	UK 2.5/4	<b>476 224</b>	15			
UK 2.5/10	<b>476 229</b>	5	UK 2.5/10	<b>476 229</b>	5	UK 2.5/10	<b>476 229</b>	5			
TF (Ø2)	<b>493 020</b>	5	TF (Ø2)	<b>493 020</b>	5	TF (Ø2)	<b>493 020</b>	5	TF (Ø2)	<b>493 020</b>	5
GE	<b>496 110</b>	50	GE	<b>496 110</b>	50	GE	<b>496 110</b>	50	GE	<b>496 110</b>	50
GE	<b>496 119</b>	50	GE	<b>496 119</b>	50	GE	<b>496 119</b>	50	GE	<b>496 119</b>	50



**YBK SERIES**

**DOUBLE-DECK  
TENSION CLAMP TERMINALS**

**YBK 4-2F**

WIDTH 6 MM  
318 109

**YBK 4-2FK**

WIDTH 6 MM  
318 129

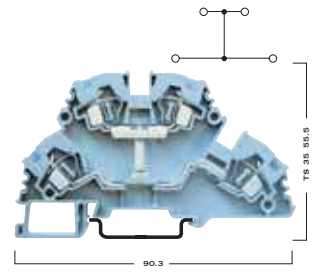
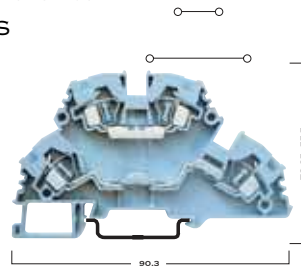

**ELECTRICAL RATINGS**

VOLTAGE/CURRENT/CROSS-SECTION  
UL

750 V~ / 30 A / 4 MM <sup>2</sup>	750 V~ / 30 A / 4 MM <sup>2</sup>
600 V~ / 26 A / AWG 22-10	600 V~ / 26 A / AWG 22-10

INSULATION STRIPPING LENGTH

12 MM	12 MM
-------	-------

**CONNECTION DATA**

SOLID STRAND, SCREW CONNECTION  
FINE STRAND, SCREW CONNECTION  
AWG CONDUCTOR

0.5 - 4 MM <sup>2</sup>	0.5 - 4 MM <sup>2</sup>
0.5 - 4 MM <sup>2</sup>	0.5 - 4 MM <sup>2</sup>
22 - 10	22 - 10

**ORDERING DATA**

POLYAMIDE 6.6  
BEIGE  
GREY

PART No.	STD. PK.	PART No.	STD. PK.
<b>318 100</b>	<b>50</b>	<b>318 120</b>	<b>20</b>
<b>318 109</b>	<b>50</b>	<b>318 129</b>	<b>20</b>

**MOUNTING RAILS**

TS 35X7.5 SOLID TS 35X15 SOLID  
TS 35X7.5 SLOTTED TS 35X15 SLOTTED



STEEL SLOT DIM. ALUMINUM SLOT DIM.  
25MM ON 36MM CENTER 13MM ON 26MM CENTER  
5.2MM SLOT WIDTH 5MM SLOT WIDTH

TYPE	PART No.	STD. PK.	TYPE	PART No.	STD. PK.
SLOTTED			SLOTTED		
35X7.5	<b>TS3575SL</b>	2M	35X7.5	<b>TS3575SL</b>	2M
35X7.5	<b>TS3575SL1</b>	1M	35X7.5	<b>TS3575SL1</b>	1M
35X7.5	<b>TS3575SL1-A</b>	1M	35X7.5	<b>TS3575SL1-A</b>	1M
35X15	<b>TS3515SL</b>	2M	35X15	<b>TS3515SL</b>	2M
SOLID			SOLID		
35X7.5	<b>TS3575SOL</b>	2M	35X7.5	<b>TS3575SOL</b>	2M
35X15	<b>TS3515SOL</b>	2M	35X15	<b>TS3515SOL</b>	2M

**END BRACKET**

THICKNESS 8MM  
KD 3  
BEIGE  
GREY



KD 3	<b>495 040</b>	100	KD 3	<b>495 040</b>	100
KD 3	<b>495 049</b>	100	KD 3	<b>495 049</b>	100

**END PLATE - PARTITION**

THICKNESS 1.5MM  
POLYAMIDE 6.6  
NPP  
BEIGE  
GREY



NPP	<b>446 260</b>	25	NPP	<b>446 260</b>	25
NPP	<b>446 269</b>	25	NPP	<b>446 269</b>	25

**CROSS CONNECTION**



UK 4/2	<b>476 232</b>	25	UK 4/2	<b>476 232</b>	25
UK 4/3	<b>476 233</b>	20	UK 4/3	<b>476 233</b>	20
UK 4/4	<b>476 234</b>	15	UK 4/4	<b>476 234</b>	15
UK 4/10	<b>476 239</b>	5	UK 4/10	<b>476 239</b>	5

**TEST PLUG-SOC. / INS. TEST SOC.**



TF (Ø2)	<b>493 020</b>	5	TF (Ø2)	<b>493 020</b>	5
---------	----------------	---	---------	----------------	---

**GROUP MARKING**



GE	<b>496 110</b>	50	GE	<b>496 110</b>	50
GE	<b>496 119</b>	50	GE	<b>496 119</b>	50

**MARKING TAGS**

SEE PAGE 34 FOR FURTHER DETAIL.

# PIK 4N SERIES

## DOUBLE-DECK TERMINALS AND ACCESSORIES



### PIK 4 N

WIDTH 6 MM  
319 100 BEIGE  
319 109 GREY

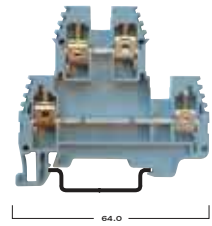

TORQUE: 0.5 NM

### PIK 4 NK

WIDTH 6 MM  
319 120 BEIGE  
319 129 GREY

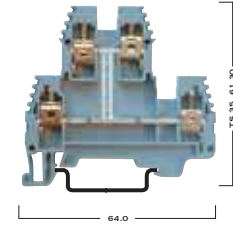

TORQUE: 0.5 NM

<b>ELECTRICAL RATINGS</b>					
VOLTAGE/CURRENT/CROSS-SECTION		750 V~ / 34 A / 4 MM <sup>2</sup>		750 V~ / 34 A / 4 MM <sup>2</sup>	
VDE (IEC 60947-7-1)		500 V~ / 32 A / 4 MM <sup>2</sup>		500 V~ / 32 A / 4 MM <sup>2</sup>	
UL		300 V~ / 32 A / AWG 26-10		300 V~ / 32 A / AWG 26-10	
INSULATION STRIPPING LENGTH		9 MM		9 MM	
<b>CONNECTION DATA</b>					
SOLID STRAND, SCREW CONNECTION		0.5 - 6 MM <sup>2</sup>		0.5 - 6 MM <sup>2</sup>	
FINE STRAND, SCREW CONNECTION		1.5 - 4 MM <sup>2</sup>		1.5 - 4 MM <sup>2</sup>	
AWG CONDUCTOR		26 - 10		26 - 10	
<b>ORDERING DATA</b>		PART No. STD. PK.		PART No. STD. PK.	
POLYAMIDE 6.6		319 100 100		319 120 20	
BEIGE		319 109 100		319 129 20	
GREY					
<b>MOUNTING RAILS</b>		TYPE PART No. STD. PK.		TYPE PART No. STD. PK.	
TS 35x7.5 TS 35x15 SLOTTED		SLOTTED		SLOTTED	
TS 35x7.5 TS 35x15 SLOTTED		35x7.5 TS3575SL 2M		35x7.5 TS3575SL 2M	
		35x7.5 TS3575SL1 1M		35x7.5 TS3575SL1 1M	
		35x7.5 TS3575SL1-A 1M		35x7.5 TS3575SL1-A 1M	
		35x15 TS3515SL 2M		35x15 TS3515SL 2M	
		SOLID		SOLID	
		35x7.5 TS3575SOL 2M		35x7.5 TS3575SOL 2M	
		35x15 TS3515SOL 2M		35x15 TS3515SOL 2M	
<b>END BRACKET</b>		THICKNESS 8MM		THICKNESS 8MM	
KD 3		BEIGE KD 3 495 040 100		BEIGE KD 3 495 040 100	
		GREY KD 3 495 049 100		GREY KD 3 495 049 100	
<b>END PLATE - PARTITION</b>		THICKNESS 1.5MM		THICKNESS 1.5MM	
POLYAMIDE 6.6		BEIGE NPP 449 010 25		BEIGE NPP 449 010 25	
NPP		GREY NPP 449 019 25		GREY NPP 449 019 25	
<b>CROSS CONNECTION</b>		UK 4/2 474 132 25		UK 4/2 474 132 25	
		UK 4/3 474 133 20		UK 4/3 474 133 20	
		UK 4/4 474 134 15		UK 4/4 474 134 15	
		UK 4/10 474 139 5		UK 4/10 474 139 5	
<b>TEST PLUG-Soc. / INS. TEST Soc.</b>		TF (Ø2.3) 493 023 5		TF (Ø2.3) 493 023 5	
TF		TF(Ø4) 493 040 5		TF(Ø4) 493 040 5	
ITK		TSK 4(Ø2.3) 490 040 5		TSK 4(Ø2.3) 490 040 5	
TSK		TSK 7 (Ø4) 490 070 5		TSK 7 (Ø4) 490 070 5	
		ITK 28 (Ø4) 492 010 5		ITK 28 (Ø4) 492 010 5	
<b>GROUP MARKING</b>		GE		GE	
BEIGE		496 110 50		496 110 50	
GREY		496 119 50		496 119 50	
<b>MARKING TAGS</b>					
SEE PAGE 34 FOR FURTHER DETAIL.					



## PUK SERIES

### SCREW TYPE TERMINAL BLOCKS FOR INITIATORS, ACTUATORS AND MOTORS

THE PUK SERIES IS A FEED-THRU AND FEED-THRU/GROUNDING TERMINAL BLOCK SERIES USED IN APPLICATIONS UTILIZING SENSORS OR OTHER MULTIWIRE SYSTEMS. THE TERMINAL BLOCKS ARE ONLY 6MM WIDE, WHICH SAVES 2/3 TO \_ THE NORMAL SPACE UTILIZED IN STANDARD TERMINALS. THE PUK 3 AND PUK 2T BOTH HAVE AREAS FOR JUMPERING ONE OR TWO LEVELS. THIS IS PARTICULARLY TIME SAVING WHEN DAISY-CHAINING POWER OR GROUND (+ OR -).

THE PUK 2T AND PUK 3T ALLOW FEED THRU TERMINAL BLOCKS AS WELL AS DIRECT GROUNDING TO THE RAIL ASSEMBLY.



#### ELECTRICAL RATINGS

VOLTAGE/CURRENT/CROSS-SECTION  
VDE (IEC 60947-7-1)  
UL

INSULATION STRIPPING LENGTH

#### CONNECTION DATA

SOLID STRAND, SCREW CONNECTION  
FINE STRAND, SCREW CONNECTION  
AWG CONDUCTOR

#### ORDERING DATA

POLYAMIDE 6.6 GREY  
BEIGE

#### MOUNTING RAILS

TS 35X7.5 SOLID	TS 35X15 SOLID
TS 35X7.5 SLOTTED	TS 35X15 SLOTTED



STEEL SLOT DIM.  
25MM ON 36MM CENTER  
5.2MM SLOT WIDTH



ALUMINUM SLOT DIM.  
13MM ON 26MM CENTER  
5MM SLOT WIDTH

#### END BRACKET

THICKNESS 8MM TS 32 & TS 35 / FOR BEIGE / GREY  
TS 35 / FOR BEIGE / GREY



#### END PLATE

THICKNESS 1.5MM BEIGE  
GREY  
POLYAMIDE 6.6 NPP PUK 3 NPP PUK 2 T NPP PUK 3 T



#### SMALL PARTITION



BEIGE  
GREY

#### CROSS CONNECTION



#### TEST PLUG-Soc. / INS. TEST Soc.



#### GROUP MARKING

GE BEIGE  
GREY



#### MARKING TAGS

SEE PAGE 34 FOR FURTHER DETAIL.

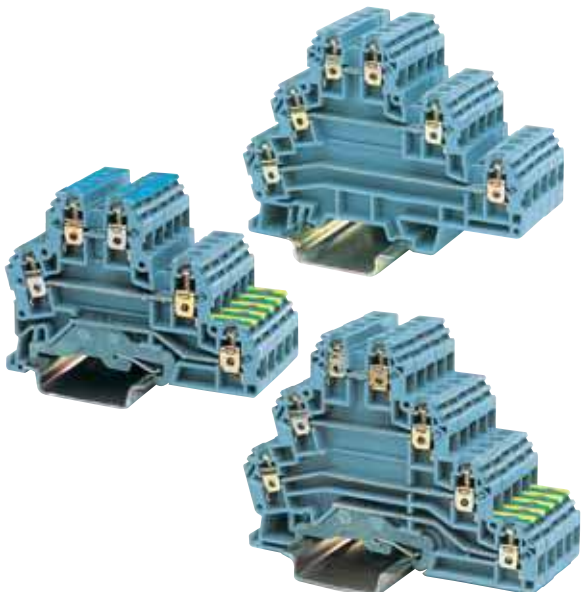
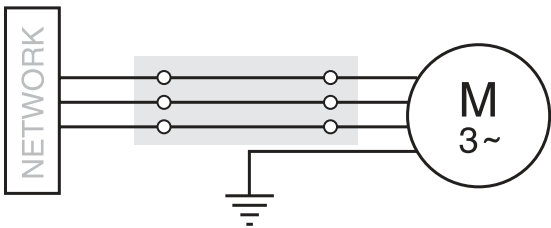



**PUK 3**

WIDTH 6 MM

324 100 BEIGE  
324 109 GREY

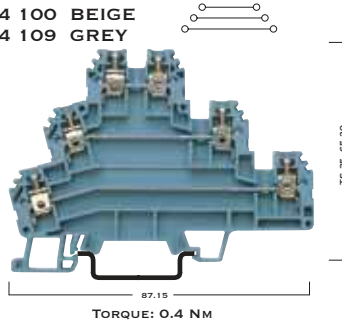

**PUK 2 T**

WIDTH 6 MM

324 200 BEIGE  
324 209 GREY

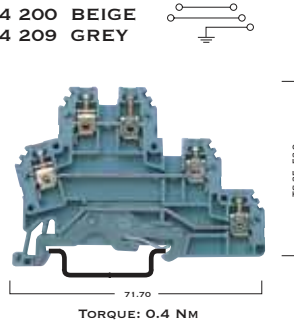

**PUK 3 T**

WIDTH 6 MM

324 300 BEIGE  
324 309 GREY

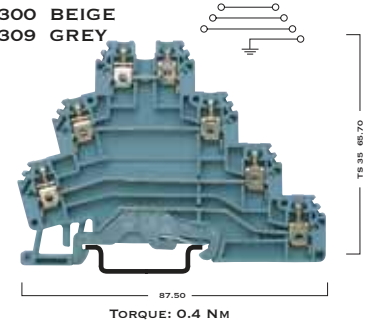

PUK 3			PUK 2 T			PUK 3 T		
500 V~ / 24 A / 2.5 MM <sup>2</sup>	500 V~ / 24 A / 2.5 MM <sup>2</sup>	500 V~ / 24 A / 2.5 MM <sup>2</sup>	440 V~ / 24 A / 2.5 MM <sup>2</sup>	440 V~ / 24 A / 2.5 MM <sup>2</sup>	440 V~ / 24 A / 2.5 MM <sup>2</sup>	300 V~ / 24 A / 24...12 AWG	300 V~ / 24 A / 24...12 AWG	300 V~ / 24 A / 24...12 AWG
9 MM	9 MM	9 MM	9 MM	9 MM	9 MM	9 MM	9 MM	9 MM
0.5 - 4 MM <sup>2</sup>	0.5 - 4 MM <sup>2</sup>	0.5 - 4 MM <sup>2</sup>	0.5 - 4 MM <sup>2</sup>	0.5 - 4 MM <sup>2</sup>	0.5 - 4 MM <sup>2</sup>	1.5 - 2.5 MM <sup>2</sup>	1.5 - 2.5 MM <sup>2</sup>	1.5 - 2.5 MM <sup>2</sup>
26 - 12	26 - 12	26 - 12	26 - 12	26 - 12	26 - 12	26 - 12	26 - 12	26 - 12
PART No.	STD. PK.	PART No.	STD. PK.	PART No.	STD. PK.	PART No.	STD. PK.	PART No.
<b>324 100</b>	<b>25</b>	<b>324 200</b>	<b>25</b>	<b>324 300</b>	<b>25</b>	<b>324 109</b>	<b>25</b>	<b>324 309</b>
<b>324 109</b>	<b>25</b>	<b>324 209</b>	<b>25</b>	<b>324 309</b>	<b>25</b>			
TYPE	PART No.	STD. PK.	TYPE	PART No.	STD. PK.	TYPE	PART No.	STD. PK.
SLOTTED			SLOTTED			SLOTTED		
35x7.5	<b>TS3575SL</b>	2M	35x7.5	<b>TS3575SL</b>	2M	35x7.5	<b>TS3575SL</b>	2M
35x7.5	<b>TS3575SL1</b>	1M	35x7.5	<b>TS3575SL1</b>	1M	35x7.5	<b>TS3575SL1</b>	1M
35x7.5	<b>TS3575SL1-A</b>	1M	35x7.5	<b>TS3575SL1-A</b>	1M	35x7.5	<b>TS3575SL1-A</b>	1M
35x15	<b>TS3515SL</b>	2M	35x15	<b>TS3515SL</b>	2M	35x15	<b>TS3515SL</b>	2M
SOLID			SOLID			SOLID		
35x7.5	<b>TS3575SOL</b>	2M	35x7.5	<b>TS3575SOL</b>	2M	35x7.5	<b>TS3575SOL</b>	2M
35x15	<b>TS3515SOL</b>	2M	35x15	<b>TS3515SOL</b>	2M	35x15	<b>TS3515SOL</b>	2M
KD 3	<b>495 040 / 495 049</b>	100	KD 3	<b>495 040 / 495 049</b>	100	KD 3	<b>495 040 / 495 049</b>	100
NPP	<b>450 130</b>	10	NPP	<b>450 140</b>	10	NPP	<b>450 150</b>	10
NPP	<b>450 139</b>	10	NPP	<b>450 149</b>	10	NPP	<b>450 159</b>	10
AD 1	<b>467 910</b>	100	AD 1	<b>467 910</b>	100	AD 1	<b>467 910</b>	100
AD 1	<b>467 919</b>	100	AD 1	<b>467 919</b>	100	AD 1	<b>467 919</b>	100
UK 2.5/2	<b>480 132</b>	25	UK 2.5/2	<b>480 132</b>	25	UK 2.5/2	<b>480 132</b>	25
UK 2.5/3	<b>480 133</b>	20	UK 2.5/3	<b>480 133</b>	20	UK 2.5/3	<b>480 133</b>	20
UK 2.5/4	<b>480 134</b>	15	UK 2.5/4	<b>480 134</b>	15	UK 2.5/4	<b>480 134</b>	15
UK 2.5/10	<b>480 139</b>	5	UK 2.5/10	<b>480 139</b>	5	UK 2.5/10	<b>480 139</b>	5
TF(Ø2.3)	<b>493 023</b>	5	TF(Ø2.3)	<b>493 023</b>	5	TF(Ø2.3)	<b>493 023</b>	5
TSK 3 (Ø2.3)	<b>490 030</b>	5	TSK 3 (Ø2.3)	<b>490 030</b>	5	TSK 3 (Ø2.3)	<b>490 030</b>	5
GE	<b>496 110</b>	50	GE	<b>496 110</b>	50	GE	<b>496 110</b>	50
GE	<b>496 119</b>	50	GE	<b>496 119</b>	50	GE	<b>496 119</b>	50



## ASK SERIES DISCONNECT TERMINALS

**ASK 3 A**  
WIDTH 6 MM  
353 100 BEIGE  
353 109 GREY

**ASK 2 B**  
WIDTH 8 MM  
360 110 BEIGE  
360 119 GREY

### DISCONNECT TERMINALS

THE MAIN ADVANTAGE WITH DISCONNECT TERMINALS IS THAT THEY ALLOW A CIRCUIT TO BE “OPENED” WITHOUT REMOVING THE WIRE FROM THE SCREW CONNECTIONS – SAVING TIME.

THE ANALOG CIRCUITS SUCH AS 4-20 MA SIGNALS, THE USER CAN OPEN THE CIRCUIT (ASK 2B) AND PLACE A MULTIMETER ON THE EXPOSED INTERNAL TERMINALS AND “READ” INPUT OR OUTPUT CURRENTS VERY EASILY.

### FUSE TERMINAL BLOCKS

STANDARD 5X20MM AND 5X25MM FUSES CAN BE USED WITH THESE TERMINALS. THE STANDARD LEVER ACTION FUSE TERMINAL IS THE ASK 2S.

IF YOU WISH TO HAVE FUSE BLOWN INDICATION FOR YOUR CONTROL CIRCUIT IN ORDER TO ENHANCE TROUBLE SHOOTING, THEN THE ASK LD IS A GOOD DEVICE. THE FUSE HOLDER PORTIONS CAN BE COMPLETELY REMOVED WITH THE ASK 3F AND IT ALSO HOLDS A SPARE FUSE.

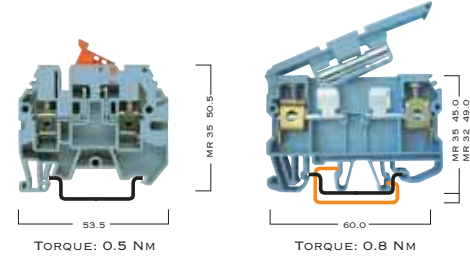

<b>ELECTRICAL RATINGS</b>		500 V~ / 24 A / 4 MM <sup>2</sup>		500 V~ / 6.3 A / 6 MM <sup>2</sup>	
VOLTAGE/CURRENT/CROSS-SECTION		600 V~ / 16 A / AWG 26-10		300 V~ / 6.3 A / AWG 26-8	
UL					
INSULATION STRIPPING LENGTH		10 MM		12 MM	
<b>CONNECTION DATA</b>					
SOLID STRAND, SCREW CONNECTION		0.5 - 6 MM <sup>2</sup>		0.5 - 10 MM <sup>2</sup>	
FINE STRAND, SCREW CONNECTION		1.5 - 4 MM <sup>2</sup>		1.5 - 10 MM <sup>2</sup>	
AWG CONDUCTOR		26 - 10		26 - 8	
<b>ORDERING DATA</b>		PART No.		STD. PK.	
POLYAMIDE 6.6		353 100		20	
BEIGE		360 110		20	
GREY		353 109		20	
360 119				20	
<b>MOUNTING RAILS</b>		TYPE		PART No.	
TS 35X7.5 SOLID		TS 35X15 SOLID		STD. PK.	
TS 35X7.5 SLOTTED		TS 35X15 SLOTTED		TYPE	
				PART No.	
				STD. PK.	
		SLOTTED		SLOTTED	
		35X7.5		TS3575SL	
		2M		35X7.5	
		TS3575SL1		1M	
		35X7.5		TS3575SL1-A	
		1M		35X7.5	
		TS3575SL1-A		1M	
		35X15		TS3515SL	
		2M		35X15	
		TS3515SL		2M	
		SOLID		SOLID	
		35X7.5		TS3575SOL	
		2M		35X7.5	
		TS3575SOL		2M	
		35X15		TS3515SOL	
		2M		35X15	
		TS3515SOL		2M	
<b>END BRACKET</b>		THICKNESS 8MM		BEIGE	
KD 3		495 040		100	
		495 049		100	
				100	
<b>END PLATE</b>		THICKNESS 1.5MM		BEIGE	
NPP ASK 3		450 050		10	
NPP ASK 2		450 059		10	
				10	
<b>CROSS CONNECTION</b>		UK 4/2		476 232	
		25			
		UK 4/3		476 233	
		20			
		UK 4/4		476 234	
		15			
		UK 4/10		476 239	
		5			
<b>GROUP MARKING</b>		GE		BEIGE	
496 110		50		496 110	
496 119		50		496 119	
				50	
<b>MARKING TAGS</b>					
SEE PAGE 34 FOR FURTHER DETAIL.					

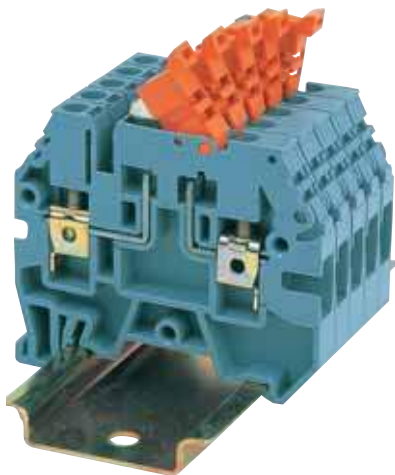

# ASK SERIES

SCREW-TYPE  
FUSE TERMINALS

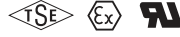

## ASK 2 S

WIDTH 8 MM  
351 100 BEIGE  
351 109 GREY

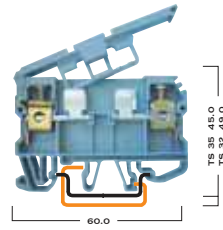

TORQUE: 0.8 NM

## ASK 2 LD

WIDTH 8 MM  
--- --0 BEIGE  
--- --9 GREY

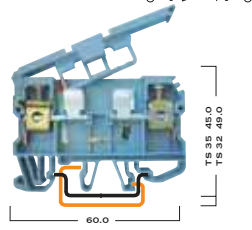

TORQUE: 0.8 NM

## ASK 3 F

WIDTH 6 MM  
354 100 BEIGE  
354 109 GREY

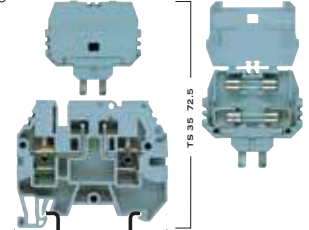

TORQUE: 0.5 NM

### ELECTRICAL RATINGS

VOLTAGE/CURRENT/CROSS-SECTION  
UL

500 V~ / 6.3 A / 6 MM <sup>2</sup>	- V~ / 6.3 A / 6 MM <sup>2</sup>	600 V~ / 6.3 A / 4 MM <sup>2</sup>
300 V~ / 6.3 A / AWG 26-8	- V~ / 6.3 A / AWG 26-8	600 V~ / 10 A / AWG 26-10

FUSE SIZE

5x20, 5x25 MM	5x20, 5x25 MM	5x20, 5x25 MM
---------------	---------------	---------------

INSULATION STRIPPING LENGTH

12 MM	12 MM	12 MM
-------	-------	-------

### CONNECTION DATA

SOLID STRAND, SCREW CONNECTION

0.5 - 10 MM <sup>2</sup>	0.5 - 10 MM <sup>2</sup>	0.5 - 6 MM <sup>2</sup>
--------------------------	--------------------------	-------------------------

FINE STRAND, SCREW CONNECTION

1.5 - 10 MM <sup>2</sup>	1.5 - 10 MM <sup>2</sup>	1.5 - 4 MM <sup>2</sup>
--------------------------	--------------------------	-------------------------

AWG CONDUCTOR

26 - 8	26 - 8	26 - 10
--------	--------	---------

### ORDERING DATA

PART No.	STD. PK.	PART No.	STD. PK.	PART No.	STD. PK.
351 100 / 351 109	50	351 220 / 351 229 (24V DC)	25	354 100 / 354 109	20
		351 310 / 351 319 (48V AC)	25		
		351 320 / 351 319 (48V DC)	25		
		351 510 / 351 519 (110V AC)	25		

### MOUNTING RAILS

TS 35X7.5 TS 35X15 SLOTTED  
TS 35X7.5 TS 35X15 SLOTTED



STEEL SLOT DIM.  
25MM ON 36MM CENTER  
5.2MM SLOT WIDTH



ALUMINUM SLOT DIM.  
13MM ON 26MM CENTER  
5MM SLOT WIDTH

TYPE	PART No.	STD. PK.	TYPE	PART No.	STD. PK.	TYPE	PART No.	STD. PK.
SLOTTED			SLOTTED			SLOTTED		
35x7.5	TS3575SL	2M	35x7.5	TS3575SL	2M	35x7.5	TS3575SL	2M
35x7.5	TS3575SL1	1M	35x7.5	TS3575SL1	1M	35x7.5	TS3575SL1	1M
35x7.5	TS3575SL1-A	1M	35x7.5	TS3575SL1-A	1M	35x7.5	TS3575SL1-A	1M
35x15	TS3515SL	2M	35x15	TS3515SL	2M	35x15	TS3515SL	2M
SOLID			SOLID			SOLID		
35x7.5	TS3575SOL	2M	35x7.5	TS3575SOL	2M	35x7.5	TS3575SOL	2M
35x15	TS3515SOL	2M	35x15	TS3515SOL	2M	35x15	TS3515SOL	2M

### END BRACKET

THICKNESS 8MM  
KD 3 BEIGE  
KD 3 GREY



KD 3	495 040	100	KD 3	495 040	100	KD 3	495 040	100
KD 3	495 049	100	KD 3	495 049	100	KD 3	495 049	100

### END PLATE - PARTITION

THICKNESS 1.5MM  
POLYAMIDE 6.6 BEIGE  
POLYAMIDE 6.6 GREY

NPP ASK 3 NPP ASK 2



NPP	450 040	10	NPP	450 040	10	NPP	450 050	10
NPP	450 049	10	NPP	450 049	10	NPP	450 059	10

### CROSS CONNECTION



UK 4/2	476 232	25
UK 4/3	476 233	20
UK 4/4	476 234	15
UK 4/10	476 239	5

### GROUP MARKING

GE BEIGE  
GE GREY



GE	496 110	50	GE	496 110	50	GE	496 110	50
GE	496 119	50	GE	496 119	50	GE	496 119	50

### MARKING TAGS

SEE PAGE 34 FOR FURTHER DETAIL.



## YBK SERIES

### TENSION CLAMP FUSE AND DISCONNECT TERMINALS

THE YBK SERIES FOR FUSE BLOCKS UTILIZE  
SPRING CLAMP TECHNOLOGY AND FUSING FOR  
5X20MM, 5X25MM AND 1 1/4" X 1/4" TYPES.



#### ELECTRICAL RATINGS

VOLTAGE/CURRENT/CROSS-SECTION  
UL / CSA

FUSE SIZE  
INSULATION STRIPPING LENGTH

#### CONNECTION DATA

SOLID STRAND, SCREW CONNECTION  
FINE STRAND, SCREW CONNECTION  
AWG CONDUCTOR

#### ORDERING DATA

POLYAMIDE 6.6  
GREY  
BEIGE  
GREY  
BEIGE

#### MOUNTING RAILS

TS 35X7.5 SOLID                      TS 35X15 SOLID  
TS 35X7.5 SLOTTED                TS 35X15 SLOTTED



STEEL SLOT DIM.  
25MM ON 36MM CENTER  
5.2MM SLOT WIDTH

ALUMINUM SLOT DIM.  
13MM ON 26MM CENTER  
5MM SLOT WIDTH

#### END BRACKET

THICKNESS 8MM  
KD 3  
BEIGE  
GREY



#### END PLATE

THICKNESS 1.5MM  
POLYAMIDE 6.6  
NPP YBK S - YBK I  
BEIGE  
GREY



#### CROSS CONNECTION



#### GROUP MARKING

GE  
BEIGE  
GREY



#### MARKING TAGS

SEE PAGE 34 FOR FURTHER DETAIL.

### YBK S

WIDTH 8 MM  
 355 110 BEIGE  
 355 119 GREY

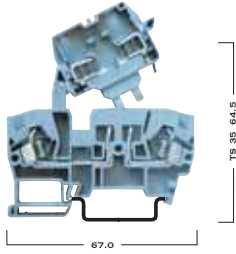

### YBK SLD

WIDTH 8 MM  
 ---0 BEIGE  
 ---9 GREY

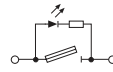
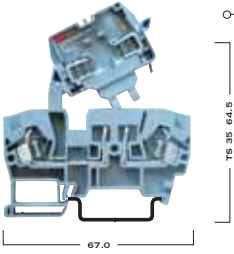

### YBK I

WIDTH 8 MM  
 355 120 BEIGE  
 355 129 GREY

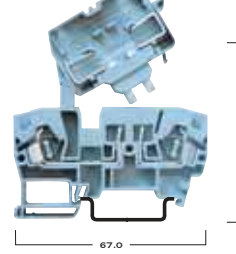

500 V~ / - A / 4 MM <sup>2</sup>	- V~ / - A / 4 MM <sup>2</sup>	500 V~ / - A / 4 MM <sup>2</sup>
600 V~ / - A / AWG 22-10	- V~ / - A / AWG 22-10	600 V~ / - A / AWG 22-10
5x20, 5x25 MM	5x20, 5x25 MM	11/4x1/4"
12 MM	12 MM	12 MM
0.5 -4 MM <sup>2</sup>	0.5 -4 MM <sup>2</sup>	0.5 -4 MM <sup>2</sup>
0.5 -4 MM <sup>2</sup>	0.5 -4 MM <sup>2</sup>	0.5 -4 MM <sup>2</sup>
22 - 10	22 - 10	22 - 10
PART NO.	STD. PK.	PART NO.
<b>355 110</b>	<b>20</b>	<b>355 720</b> (24V DC)
<b>355 119</b>	<b>20</b>	<b>355 729</b> (24V DC)
		<b>355 750</b> (110V DC)
		<b>355 759</b> (110V DC)

TYPE	PART NO.	STD. PK.	TYPE	PART NO.	STD. PK.	TYPE	PART NO.	STD. PK.
SLOTTED			SLOTTED			SLOTTED		
35x7.5	<b>TS3575SL</b>	2M	35x7.5	<b>TS3575SL</b>	2M	35x7.5	<b>TS3575SL</b>	2M
35x7.5	<b>TS3575SL1</b>	1M	35x7.5	<b>TS3575SL1</b>	1M	35x7.5	<b>TS3575SL1</b>	1M
35x7.5	<b>TS3575SL1-A</b>	1M	35x7.5	<b>TS3575SL1-A</b>	1M	35x7.5	<b>TS3575SL1-A</b>	1M
35x15	<b>TS3515SL</b>	2M	35x15	<b>TS3515SL</b>	2M	35x15	<b>TS3515SL</b>	2M
SOLID			SOLID			SOLID		
35x7.5	<b>TS3575SOL</b>	2M	35x7.5	<b>TS3575SOL</b>	2M	35x7.5	<b>TS3575SOL</b>	2M
35x15	<b>TS3515SOL</b>	2M	35x15	<b>TS3515SOL</b>	2M	35x15	<b>TS3515SOL</b>	2M
KD 3	<b>495 040</b>	100	KD 3	<b>495 040</b>	100	KD 3	<b>495 040</b>	100
KD 3	<b>495 049</b>	100	KD 3	<b>495 049</b>	100	KD 3	<b>495 049</b>	100

NPP	<b>450 060</b>	10	NPP	<b>450 060</b>	10	NPP	<b>450 060</b>	10
NPP	<b>450 069</b>	10	NPP	<b>450 069</b>	10	NPP	<b>450 069</b>	10

UK 6/2	<b>476 242</b>	25	UK 6/2	<b>476 242</b>	25	UK 6/2	<b>476 242</b>	25
UK 6/3	<b>476 243</b>	20	UK 6/3	<b>476 243</b>	20	UK 6/3	<b>476 243</b>	20
UK 6/4	<b>476 244</b>	15	UK 6/4	<b>476 244</b>	15	UK 6/4	<b>476 244</b>	15
UK 6/10	<b>476 249</b>	5	UK 6/10	<b>476 249</b>	5	UK 6/10	<b>476 249</b>	5

GE	<b>496 110</b>	50	GE	<b>496 110</b>	50	GE	<b>496 110</b>	50
GE	<b>496 119</b>	50	GE	<b>496 119</b>	50	GE	<b>496 119</b>	50



## ASK SERIES

### FUSE TERMINALS

ASK 4 SERIES OF FUSE TERMINALS BLOCKS ARE USED WITH 1 1/4" X 1/4" FUSES. PLEASE NOTE THAT THIS TERMINAL BLOCK IS COMPLETELY ENCLOSED AND DOES NOT REQUIRE AN END COVER. THEY ARE OFFERED IN STANDARD AND WITH FUSE BLOWN INDICATION.



### ASK 4 S

WIDTH 10 MM  
351 120 BEIGE  
351 129 GREY

### ASK 4 LD

WIDTH 10 MM  
--- --0 BEIGE  
--- --9 GREY

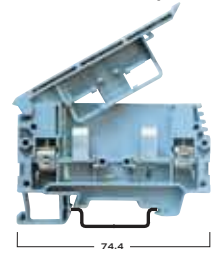
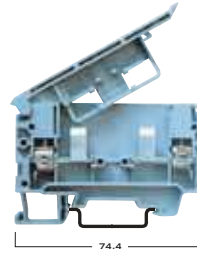
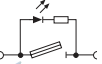

TORQUE: 0.8 NM

TORQUE: 0.8 NM

#### ELECTRICAL RATINGS

VOLTAGE/CURRENT/CROSS-SECTION  
UL

750 V~ / 6.3 A / 6 MM <sup>2</sup>	- V~ / - A / 6 MM <sup>2</sup>
600 V~ / 6.3 A / AWG 22-8	- V~ / - A / AWG 22-8

FUSE SIZE  
INSULATION STRIPPING LENGTH

1 1/4x1/4"	1 1/4x1/4"
12 MM	12 MM

#### CONNECTION DATA

SOLID STRAND, SCREW CONNECTION  
FINE STRAND, SCREW CONNECTION  
AWG CONDUCTOR

0.5 - 10 MM <sup>2</sup>	0.5 - 10 MM <sup>2</sup>
1.5 - 6 MM <sup>2</sup>	1.5 - 6 MM <sup>2</sup>
22 - 8	22 - 8

#### ORDERING DATA

POLYAMIDE 6.6		PART No.	STD. PK.	PART No.	STD. PK.
BEIGE	351 120	20	351 720 (24V DC)	20	
GREY	351 129	20	351 729 (24V DC)	20	
			351 750 (110V AC)	20	
			351 759 (110V AC)	20	

#### MOUNTING RAILS

TS 35X7.5 SOLID      TS 35X15 SOLID  
TS 35X7.5 SLOTTED      TS 35X15 SLOTTED



STEEL SLOT DIM.      ALUMINUM SLOT DIM.  
25MM ON 36MM CENTER      13MM ON 26MM CENTER  
5.2MM SLOT WIDTH      5MM SLOT WIDTH

TYPE	PART No.	STD. PK.	TYPE	PART No.	STD. PK.
SLOTTED			SLOTTED		
35X7.5	TS3575SL	2M	35X7.5	TS3575SL	2M
35X7.5	TS3575SL1	1M	35X7.5	TS3575SL1	1M
35X7.5	TS3575SL1-A	1M	35X7.5	TS3575SL1-A	1M
35X15	TS3515SL	2M	35X15	TS3515SL	2M
SOLID			SOLID		
35X7.5	TS3575SOL	2M	35X7.5	TS3575SOL	2M
35X15	TS3515SOL	2M	35X15	TS3515SOL	2M

#### END BRACKET

THICKNESS 8MM      BEIGE  
KD 3      GREY



KD 3	495 040	100	KD 3	495 040	100
KD 3	495 049	100	KD 3	495 049	100

#### END PLATE

ENDPLATES ARE INCLUDED ON BLOCK

#### GROUP MARKING

GE



BEIGE  
GREY

GE	496 110	50	GE	496 110	50
GE	496 119	50	GE	496 119	50

#### MARKING TAGS

SEE PAGE 34 FOR FURTHER DETAIL.

# WGO SERIES

## DISCONNECT TERMINALS

### WGO 1

WIDTH 8 MM

- -0- BEIGE
- -9- GREY

### WGO 2

WIDTH 10 MM

- -0- BEIGE
- -9- GREY

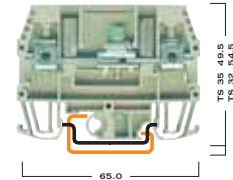
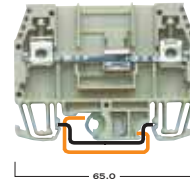

TORQUE: 0.8 NM

TORQUE: 1.2 NM

<b>ELECTRICAL RATINGS</b>									
VOLTAGE/CURRENT/CROSS-SECTION		380V~ / 44 A / 6 MM <sup>2</sup>		350 V~ / 61 A / 10 MM <sup>2</sup>					
IEC 60947-7-1				400 V~ / 57 A / 10 MM <sup>2</sup>					
UL				600 V~ / 50 A / AWG 16-8					
INSULATION STRIPPING LENGTH		12 MM		12 MM					
<b>CONNECTION DATA</b>									
SOLID STRAND, SCREW CONNECTION		0.5 - 10 MM <sup>2</sup>		0.5 - 16 MM <sup>2</sup>					
FINE STRAND, SCREW CONNECTION		1.5 - 6 MM <sup>2</sup>		1.5 - 10 MM <sup>2</sup>					
AWG CONDUCTOR		20 - 8		16 - 8					
<b>ORDERING DATA</b>		PART No.	STD. Pk.	PART No.	STD. Pk.				
POLYAMIDE 6.6									
W/O TEST SOCKET BEIGE		<b>370 500</b>	<b>20</b>	<b>375 500</b>	<b>20</b>				
W/ TEST SOCKET BEIGE		<b>370 501</b>	<b>20</b>	<b>375 501</b>	<b>20</b>				
DOUBLE TEST SOCKET BEIGE		<b>370 502</b>	<b>20</b>	<b>375 502</b>	<b>20</b>				
W/O TEST SOCKET GREY		<b>370 590</b>	<b>20</b>	<b>375 590</b>	<b>20</b>				
W/ TEST SOCKET GREY		<b>370 591</b>	<b>20</b>	<b>375 591</b>	<b>20</b>				
DOUBLE TEST SOCKET GREY		<b>370 592</b>	<b>20</b>	<b>375 592</b>	<b>20</b>				
<b>MOUNTING RAILS</b>		TYPE	PART No.	STD. Pk.	TYPE	PART No.	STD. Pk.		
TS 35x7.5		TS 35x15 SLOTTED		SLOTTED		SLOTTED			
TS 35x7.5		TS 35x15 SLOTTED		35x7.5	<b>TS3575SL</b>	2M	35x7.5	<b>TS3575SL</b>	2M
				35x7.5	<b>TS3575SL1</b>	1M	35x7.5	<b>TS3575SL1</b>	1M
				35x7.5	<b>TS3575SL1-A</b>	1M	35x7.5	<b>TS3575SL1-A</b>	1M
				35x15	<b>TS3515SL</b>	2M	35x15	<b>TS3515SL</b>	2M
				SOLID		SOLID			
				35x7.5	<b>TS3575SOL</b>	2M	35x7.5	<b>TS3575SOL</b>	2M
				35x15	<b>TS3515SOL</b>	2M	35x15	<b>TS3515SOL</b>	2M
<b>END BRACKET</b>									
THICKNESS 8MM		BEIGE		KD 3	<b>495 040</b>	100	KD 3	<b>495 040</b>	100
KD 3		GREY		KD 3	<b>495 049</b>	100	KD 3	<b>495 049</b>	100
<b>END PLATE</b>									
THICKNESS 1.5MM		BEIGE		NPP	<b>450 100</b>	5	NPP	<b>450 100</b>	5
NPP WGO 1-2		GREY		NPP	<b>450 109</b>	5	NPP	<b>450 109</b>	5
<b>SMALL PARTITION</b>									
		BEIGE		AD 2	<b>467 950</b>	100	AD 2	<b>467 950</b>	100
		GREY		AD 2	<b>467 959</b>	100	AD 2	<b>467 959</b>	100
<b>CROSS CONNECTION</b>									
				UK 6/2	<b>480 182</b>	10	UK 10/2	<b>480 172</b>	10
				UK 6/3	<b>480 183</b>	10	UK 10/3	<b>480 173</b>	10
				UK 6/4	<b>480 184</b>	10	UK 10/4	<b>480 174</b>	10
				UK 6/10	<b>480 189</b>	5	UK 10/10	<b>480 179</b>	5
<b>SWITCHABLE CROSS CONNECTION LINKS</b>									
				CK 6	<b>485 506</b>	10	CK 10	<b>485 510</b>	10
<b>TEST PLUG-Soc. / INS. TEST Soc.</b>									
TF		TSK		ITK 32	<b>492 020</b>	5	ITK 35	<b>492 030</b>	5
				TSK 6	<b>490 060</b>	5	TSK 6	<b>490 060</b>	5
							TF 4	<b>493 040</b>	5
<b>GROUP MARKING</b>									
GE		BEIGE		GE	<b>496 110</b>	50	GE	<b>496 110</b>	50
		GREY		GE	<b>496 119</b>	50	GE	<b>496 119</b>	50
<b>MARKING TAGS</b>									
SEE PAGE 34 FOR FURTHER DETAIL.									



## YBK/AVK SERIES

TENSION CLAMP  
DISCONNECT TERMINALS

### YBK 2.5 A

WIDTH 5 MM  
353 200 BEIGE  
353 209 GREY

### AVK 4 FS

WIDTH 8 MM  
353 300 BEIGE  
353 309 GREY

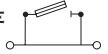

#### DISCONNECT TERMINAL

##### YBK 2.5A

THIS TERMINAL BLOCK IS A TENSION CLAMP TERMINAL THAT PROVIDES THE USER WITH THE ABILITY TO DISCONNECT THE CIRCUIT. ALSO TWO JUMPER CHANNELS ARE PROVIDED TO SUIT MOST ANY APPLICATION.

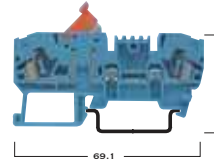

TORQUE: 0.8 NM

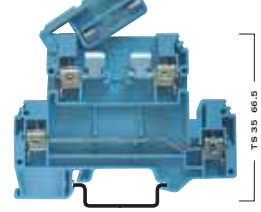

TORQUE: 0.8 NM

#### FUSE TERMINAL PLUS FEED THRU

##### AVK 4 FS

THIS TERMINAL BLOCK CAN PROTECT ONE LEG OF A CIRCUIT, WHILE FEEDING ANOTHER. IN 8MM THIS BLOCK CAN TERMINATE AND PROTECT MOST 2 WIRE SYSTEMS USING 5X20MM OR 5X25MM FUSES.

#### ELECTRICAL RATINGS

VOLTAGE/CURRENT/CROSS-SECTION

750 V~ / 16 A / 2.5 MM<sup>2</sup>      750 V~ / 32 A / 4 MM<sup>2</sup>

FUSE SIZE

5x20, 5x25 MM

INSULATION STRIPPING LENGTH

10 MM      9 MM

#### CONNECTION DATA

SOLID STRAND, SCREW CONNECTION

0.5 -2.5 MM<sup>2</sup>      0.5 -6 MM<sup>2</sup>

FINE STRAND, SCREW CONNECTION

0.5 -2.5 MM<sup>2</sup>      1.5 -4 MM<sup>2</sup>

AWG CONDUCTOR

22 - 12      24 - 10

#### ORDERING DATA

POLYAMIDE 6.6	BEIGE	STD. PK.	PART No.	STD. PK.	PART No.	STD. PK.
		50	353 200	50	353 300	50
	GREY	50	353 209	50	353 309	50

#### MOUNTING RAILS

TS 35X7.5 SOLID      TS 35X15 SOLID  
TS 35X7.5 SLOTTED      TS 35X15 SLOTTED



STEEL SLOT DIM.  
25MM ON 36MM CENTER  
5.2MM SLOT WIDTH

ALUMINUM SLOT DIM.  
13MM ON 26MM CENTER  
5MM SLOT WIDTH

TYPE	PART No.	STD. PK.	TYPE	PART No.	STD. PK.
SLOTTED			SLOTTED		
35X7.5	TS3575SL	2M	35X7.5	TS3575SL	2M
35X7.5	TS3575SL1	1M	35X7.5	TS3575SL1	1M
35X7.5	TS3575SL1-A	1M	35X7.5	TS3575SL1-A	1M
35X15	TS3515SL	2M	35X15	TS3515SL	2M
SOLID			SOLID		
35X7.5	TS3575SOL	2M	35X7.5	TS3575SOL	2M
35X15	TS3515SOL	2M	35X15	TS3515SOL	2M

#### END BRACKET

THICKNESS 8MM      BEIGE  
KD 3      GREY



KD 3	495 040	100	KD 3	495 040	100
KD 3	495 049	100	KD 3	495 049	100

#### END PLATE

THICKNESS 1.5MM      BEIGE  
POLYAMIDE 6.6      GREY  
NPP YBK S - YBK I

NPP	450 210	10	NPP	450 200	10
NPP	450 219	10	NPP	450 209	10

#### CROSS CONNECTION

UK 2.5/2	476 222	25	UK 6/2	476 242	25
UK 2.5/3	476 223	20	UK 6/3	476 243	20
UK 2.5/4	476 224	15	UK 6/4	476 244	15
UK 2.5/10	476 229	5	UK 6/10	476 249	5

#### GROUP MARKING

GE      BEIGE  
GE      GREY



GE	496 110	50	GE	496 110	50
GE	496 119	50	GE	496 119	50

#### MARKING TAGS

SEE PAGE 34 FOR FURTHER DETAIL.



## PSK SERIES

### PSK 1

### PSK 2

#### TERMINAL STRIPS



ELECTRICAL RATINGS						
VOLTAGE/CURRENT/CROSS-SECTION		380 V~ / 25 A / 2.5 MM <sup>2</sup>			600 V~ / 47 A / 6 MM <sup>2</sup>	
VDE (IEC 60998-1, IEC 60998-2-1)		400 V~ / 24 A / 2.5 MM <sup>2</sup>			600 V~ / 41 A / 6 MM <sup>2</sup>	
INSULATION STRIPPING LENGTH		5 MM			9 MM	
ORDERING DATA						
CAN BE JOINED END TO END						
TYPE	PART No.	STD. PK.	TYPE	PART No.	STD. PK.	
PSK1/2 (2'LI)	<b>420 020</b>	100	PSK2/2 (2'LI)	<b>421 020</b>	100	
PSK1/12 (12'LI)	<b>420 120</b>	75	PSK2/10 (10'LI)	<b>421 120</b>	30	

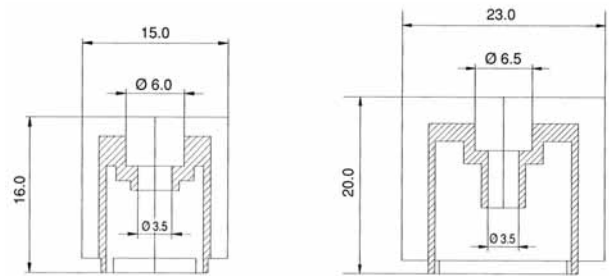

## SK SERIES

### SK 1 - 2 - 3 - 4

#### TERMINAL STRIPS



ELECTRICAL RATINGS												
VOLTAGE/CROSS-SECTION		380 V~ 450 V- / 2.5 MM <sup>2</sup>			380 V~ 450 V- / 4 MM <sup>2</sup>			380 V~ 450 V- / 6 MM <sup>2</sup>			380 V~ 450 V- / 10 MM <sup>2</sup>	
IEC 60998-1		450 V / 24 A / 2.5 MM <sup>2</sup>			450 V / 32 A / 4 MM <sup>2</sup>			450 V / 41 A / 6 MM <sup>2</sup>			450 V / 41 A / 10 MM <sup>2</sup>	
UL												
CONNECTION DATA												
SOLID STRAND, SCREW CONNECTION		0.75 – 4 MM <sup>2</sup>			0.75 – 6 MM <sup>2</sup>			0.75 – 10 MM <sup>2</sup>			0.75 – 16 MM <sup>2</sup>	
FINE STRAND, SCREW CONNECTION		1.5 – 2.5 MM <sup>2</sup>			1.5 – 4 MM <sup>2</sup>			1.5 – 6 MM <sup>2</sup>			1.5 – 10 MM <sup>2</sup>	
ORDERING DATA												
TYPE	PART No.	STD. PK.	TYPE	PART No.	STD. PK.	TYPE	PART No.	STD. PK.	TYPE	PART No.	STD. PK.	
BLACK (W/ SCREW BLOCKAGE, PASSIVE)												
SK 1	<b>430 012</b>	50	SK 2	<b>430 022</b>	50	SK 3	<b>430 032</b>	50	SK 4	<b>430 042</b>	50	
WHITE (W/ SCREW BLOCKAGE, NI COATED, NON-FLAMMABLE)												
SK 1	<b>432 012</b>	50	SK 2	<b>432 022</b>	50	SK 3	<b>432 032</b>	50	SK 4	<b>432 042</b>	50	



# FEED-THROUGH TERMINAL ACCESSORIES

## MARKING TAGS

DY5 TYP / DY5 TYPE



DB5 TYP / DB5 TYPE

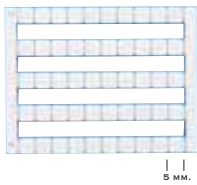

DYO 5 TYP / DYO 5 TYPE

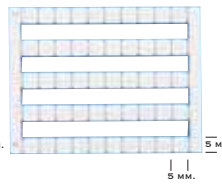

DB 10/5 TYP / TYPE DO 10/5 TYP / TYPE

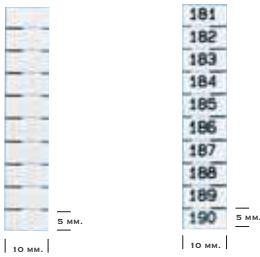

DB 10/6 TYP / TYPE DB 10/6 TYP / TYPE

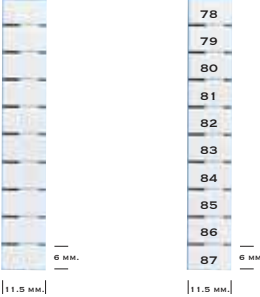

DY 10/6.5 TYP / TYPE



DB 10/6.5 TYP / TYPE



DO 10/6.5 TYP / TYPE

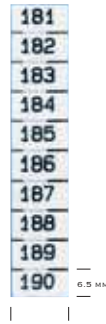

DG 5/6 TYP / TYPE

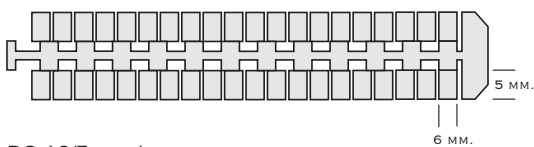

DG 10/5 TYP / TYPE

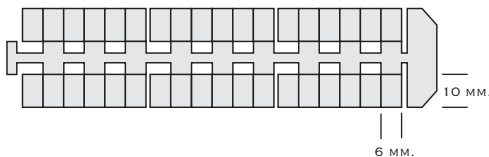

DG 10/6 TYP / TYPE

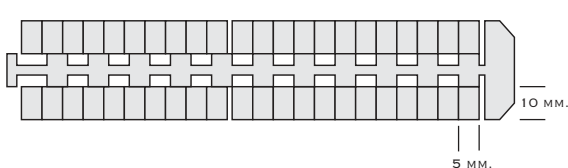

TYPE	DESCRIPTION	PART No.	STD PACK
DY 5	STANDARD PRINT	<b>505 —</b>	500
DYO 5	SPECIAL PRINT	<b>505 650</b>	500
DB 5	WITHOUT PRINT	<b>505 850</b>	500
DO 10/5	SPECIAL PRINT	<b>505 710</b>	500
DB 10/5	WITHOUT PRINT	<b>505 910</b>	500
DB 10/6	WITHOUT PRINT	<b>505 915</b>	500
DY 10/6.5	STANDARD PRINT	<b>505 —</b>	500
DO 10/6.5	SPECIAL PRINT	<b>505 720</b>	500
DB 10/6.5	WITHOUT PRINT	<b>505 920</b>	500
DG 5/6	WITHOUT PRINT	<b>505 330</b>	400
DG 10/5	WITHOUT PRINT	<b>505 310</b>	440
DG 10/6	WITHOUT PRINT	<b>505 320</b>	360

TYPE	DESCRIPTION	STD. PK.	TYPE	DESCRIPTION	STD. PK.
DY 5	0	<b>505 000</b>	DY 5	H	<b>505 067</b>
DY 5	1	<b>505 001</b>	DY 5	I	<b>505 068</b>
DY 5	2	<b>505 002</b>	DY 5	J	<b>505 069</b>
DY 5	3	<b>505 003</b>	DY 5	K	<b>505 070</b>
DY 5	4	<b>505 004</b>	DY 5	L	<b>505 071</b>
DY 5	5	<b>505 005</b>	DY 5	M	<b>505 072</b>
DY 5	6	<b>505 006</b>	DY 5	N	<b>505 073</b>
DY 5	7	<b>505 007</b>	DY 5	O	<b>505 074</b>
DY 5	8	<b>505 008</b>	DY 5	P	<b>505 075</b>
DY 5	9	<b>505 009</b>	DY 5	Q	<b>505 076</b>
DY 5	10	<b>505 010</b>	DY 5	R	<b>505 077</b>
DY 5	1-10	<b>505 020</b>	DY 5	S	<b>505 078</b>
DY 5	11-20	<b>505 021</b>	DY 5	T	<b>505 079</b>
DY 5	21-30	<b>505 022</b>	DY 5	U	<b>505 080</b>
DY 5	31-40	<b>505.023</b>	DY 5	V	<b>505 081</b>
DY 5	41-50	<b>505 024</b>	DY 5	W	<b>505 082</b>
DY 5	10-100	<b>505 030</b>	DY 5	X	<b>505 083</b>
DY 5	1-50	<b>505 040</b>	DY 5	Y	<b>505 084</b>
DY 5	51-100	<b>505 041</b>	DY 5	Z	<b>505 085</b>
DY 5	101-150	<b>505 042</b>	DY 5	L1	<b>505 090</b>
DY 5	151-200	<b>505 043</b>	DY 5	L2	<b>505 091</b>
DY 5	201-250	<b>505 044</b>	DY 5	L3	<b>505 092</b>
DY 5	251-300	<b>505 045</b>	DY 5	RSTN≠	<b>505 093</b>
DY 5	301-350	<b>505 046</b>	DY 5	MP	<b>505 094</b>
DY 5	351-400	<b>505 047</b>	DY 5	+	<b>505 095</b>
DY 5	401-450	<b>505 048</b>	DY 5	-	<b>505 096</b>
DY 5	451-500	<b>505 049</b>	DY 5	⊗	<b>505 097</b>
DY 5	501-550	<b>505 050</b>			
DY 5	551-600	<b>505 051</b>			
DY 5	601-650	<b>505 052</b>	DY 10/6.5	1-10	<b>505 201</b>
DY 5	651-700	<b>505 053</b>	DY 10/6.5	11-20	<b>505 202</b>
DY 5	701-750	<b>505 054</b>	DY 10/6.5	21-30	<b>505 203</b>
DY 5	751-800	<b>505 055</b>	DY 10/6.5	31-40	<b>505 204</b>
DY 5	801-850	<b>505 056</b>	DY 10/6.5	41-50	<b>505 205</b>
DY 5	851-900	<b>505 057</b>	DY 10/6.5	51-60	<b>505 206</b>
DY 5	901-950	<b>505 058</b>	DY 10/6.5	61-70	<b>505 207</b>
DY 5	951-999	<b>505 059</b>	DY 10/6.5	71-80	<b>505 208</b>
DY 5	A	<b>505 060</b>	DY 10/6.5	81-90	<b>505 209</b>
DY 5	B	<b>505 061</b>	DY 10/6.5	91-100	<b>505 210</b>
DY 5	C	<b>505 062</b>			
DY 5	D	<b>505 063</b>			
DY 5	E	<b>505 064</b>			
DY 5	F	<b>505 065</b>			
DY 5	G	<b>505 066</b>			

# FEED-THROUGH TERMINAL ACCESSORIES

## CABLE MARKING SLEEVES

MATERIAL: FLEXIBLE PLASTIC PVC FOR KG 1 – KG 2 (RESISTANT TO FLAME).

POLYAMIDE 6.6 FOR KE 1 – KE 2.

AMBIENT TEMPERATURE: -30° C AND + 70° C

EVERY PACKET CONTAINS ONLY ONE TYPE OF LETTER, NUMBER OR SIGN.



INS. EXT.  
DIAMETER  
2.4 – 4.4 MM<sup>2</sup>

FOR CONDUCTORS OF  
0.75 – 4 MM<sup>2</sup>



INS. EXT.  
DIAMETER  
4.0 – 8.5 MM<sup>2</sup>

FOR CONDUCTORS OF  
4 – 16 MM<sup>2</sup>



KE1

FOR CONDUCTORS OF  
0.75 ..... 1.5 MM<sup>2</sup>



KE2

FOR CONDUCTORS OF  
1.50 ..... 2.5 MM<sup>2</sup>



KE3

FOR CONDUCTORS OF  
4 - 6 MM<sup>2</sup>

TYPE	FOR CONDUCTORS MM <sup>2</sup>	QUANTITY
KG 1	0.75 – 4	100
KG 2	4 – 16	50
KE 1	0.75 – 1.5	500
KE 2	1.5 – 2.5	500
KE 3	4 – 6	500

	CHARACTER	CLOSED TYPE			OPEN TYPE			
		KG 1	KG2	COLOR	KE 1	KE2	KE3	COLOR
NUMBERS	0	515 000	516 000	Yellow	517 000	518 000	519 000	Black
	1	515 001	516 001	Yellow	517 001	518 001	519 001	Brown
	2	515 002	516 002	Yellow	517 002	518 002	519 002	Red
	3	515 003	516 003	Yellow	517 003	518 003	519 003	Orange
	4	515 004	516 004	Yellow	517 004	518 004	519 004	Light Yellow
	5	515 005	516 005	Yellow	517 005	518 005	519 005	Green
	6	515 006	516 006	Yellow	517 006	518 006	519 006	Blue
	7	515 007	516 007	Yellow	517 007	518 007	519 007	Purple
	8	515 008	516 008	Yellow	517 008	518 008	519 008	Grey
	9	515 009	516 009	Yellow	517 009	518 009	519 009	White
LETTERS	A	515 010	516 010	Yellow	517 010	518 010	519 010	Yellow
	B	515 011	516 011	Yellow	517 011	518 011	519 011	Yellow
	C	515 012	516 012	Yellow	517 012	518 012	519 012	Yellow
	D	515 013	516 013	Yellow	517 013	518 013	519 013	Yellow
	E	515 014	516 014	Yellow	517 014	518 014	519 014	Yellow
	F	515 015	516 015	Yellow	517 015	518 015	519 015	Yellow
	G	515 016	516 016	Yellow	517 016	518 016	519 016	Yellow
	H	515 017	516 017	Yellow	517 017	518 017	519 017	Yellow
	I	515 018	516 018	Yellow	517 018	518 018	519 018	Yellow
	J	515 019	516 019	Yellow	517 019	518 019	519 019	Yellow
	K	515 020	516 020	Yellow	517 020	518 020	519 020	Yellow
	L	515 021	516 021	Yellow	517 021	518 021	519 021	Yellow
	M	515 022	516 022	Yellow	517 022	518 022	519 022	Yellow
	N	515 023	516 023	Yellow	517 023	518 023	519 023	Yellow
	O	515 024	516 024	Yellow	517 024	518 024	519 024	Yellow
	P	515 025	516 025	Yellow	517 025	518 025	519 025	Yellow
	Q	515 026	516 026	Yellow	517 026	518 026	519 026	Yellow
	R	515 027	516 027	Yellow	517 027	518 027	519 027	Yellow
	S				517 028	518 028	519 028	Yellow
	T				517 029	518 029	519 029	Yellow
	U	515 030	516 030	Yellow	517 030	518 030	519 030	Yellow
	V	515 031	516 031	Yellow	517 031	518 031	519 031	Yellow
	W	515 032	516 032	Yellow	517 032	518 032	519 032	Yellow
	X	515 033	516 033	Yellow	517 033	518 033	519 033	Yellow
	Y	515 034	516 034	Yellow	517 034	518 034	519 034	Yellow
	Z	515 035	516 035	Yellow	517 035	518 035	519 035	Yellow
SIGNS	MP	515 040	516 040	Blue	517 040	518 040	519 040	Yellow
	S	515 041	516 041	Green				
	T	515 042	516 042	Red				
	+	515 043	516 043	Red	517 043	518 043	519 043	Yellow
	-	515 044	516 044	Blue	517 044	518 044	519 044	Yellow
	⚡	515 045	516 045	Yellow	517 045	518 045	519 045	Yellow
	(	515 046	516 046	Yellow	517 046	518 046	519 046	Yellow
	.	515 047	516 047	Yellow	517 047	518 047	519 047	Yellow
	/	515 048	516 048	Yellow	517 048	518 048	519 048	Yellow

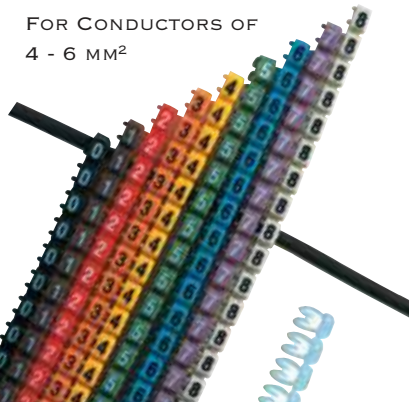



## WIRE FERRULES

WIRE FERRULES ARE USED TO TERMINATE STRANDED WIRES AND ARE MAINLY USED WITH EUROPEAN-STYLE TERMINAL BLOCKS AND OTHER IEC CONTROL COMPONENTS. AMERICAN ELECTRICAL HAS THE WIDEST SELECTION IN NORTH AMERICA. OUR FERRULES ARE ALSO MADE FOR TWIN WIRE, ON REELS, IN STRIPS, FOR EXTRA LONG APPLICATIONS AND FOR WIRES WITH THICK INSULATION. WE COVER SIZES FROM 26 AWG TO 500MCM.

AEI IS THE ONLY COMPANY IN THE USA THAT STOCKS THREE SEPARATE COLOR CODES FOR INSULATED WIRE FERRULES – DIN, T AND W. THERE IS NO DIFFERENCE OTHER THAN COLOR FOR A GIVEN FERRULE OF THE SAME AWG SIZE. THE DIN (DEUTCHE INDUSTRIE NORMEN – GERMAN) CODE IS THE MOST WIDELY USED AND ACCEPTED.

THE T CODE WAS A FRENCH CODE DESIGNED BY TELEMECHANIQUE AND THE W CODE ANOTHER EUROPEAN CODE DEVELOPED BY WEIDMULLER. BOTH TELEMECHANIQUE AND WEIDMULLER DO NOT MANUFACTURE WIRE FERRULES.

- **INSULATED FERRULES**
- **INSULATED FERRULES FOR WIRES WITH THICK INSULATION**
- **FERRULES ON STRIPS**
- **FERRULES ON REELS**
- **TWO WIRE FERRULES**
- **UNINSULATED FERRULES**
- **ASSORTMENT BOXES**
- **CROSS REFERENCE**



## TECHNICAL INFORMATION

APART FROM GIVING A HIGH QUALITY APPEARANCE, FERRULES ALSO ENSURE THE RELIABILITY OF THE CONNECTION AND INSTALLATION.

### ADVANTAGES OF WIRE FERRULES:

- EASY INSERTION OF WIRE INTO TERMINAL
- PREVENTS FLARE OUT OF STRIPPED, STRANDED WIRE
- IMPROVED CONNECTION RELIABILITY

### WIRE FERRULES WITH PLASTIC INSULATING COLLARS:

- SIMPLE IDENTIFICATION OF THE CIRCUIT AND VOLTAGE BASED ON THE COLOR OF THE INSULATED COLLAR
- ADDITIONAL INSULATION HELPS TO ISOLATE AND PROTECT AGAINST UNWANTED CONTACT WITH ELECTRICAL CIRCUITS

TECHNICAL DATA		WIRE FERRULE PULL OUT FORCES			
MATERIAL (H TYPE)	POLYPROPYLENE PP HOMO	MM <sup>2</sup>	AWG	PULL OUT FORCE LBS (N)	FERRULE
MI (MELT INDEX)	12	0.25	24	3.375 (15)	0.25
FLEXURAL	1.550 MPA	0.25	22	3.375 (15)	0.5
MOLDULUS IZOD	25	0.5	20	6.75 (30)	0.75
THERMAL PROPERTIES	89°C	1	18	6.75 (30)	1
H.D.T. – 4.6 KG/CM <sup>2</sup>	108°C	1.5	16	9 (40)	1.5
H.D.T. – 18.6 KG/CM <sup>2</sup>	-20°C	2.5	14	11.25 (50)	2.5
CRYSTAL MELTING TEMP.	164 - 168°C	4	12	11.25 (50)	4
		6	10	13.5 (60)	6
		10	8	18 (80)	10
		16	6	20.25 (90)	16
		25	4	22.5 (100)	25
		35	2	27 (120)	35
		50	1	31.5 (140)	50



# WIRE FERRULES INSULATED

DIN 46228

PART 4

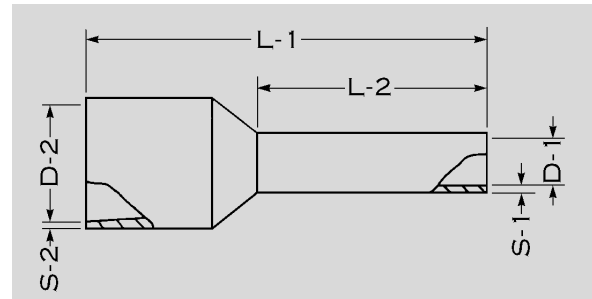

MATERIAL: COPPER / PLASTIC  
SURFACE: TIN PLATED



SIZE MM <sup>2</sup>	AWG	DIN PART NO.	COLOR CODE DIN	T PART NO.	COLOR CODE T	W PART NO.	COLOR CODE W	PIECES PER BAG	DIMENSIONS (MM)						REC. CRIMPING TOOL
									L-1	L-2	D-1	S-1	D-2	S-2	
0.14*	26	1161014	GREY	1163014	BROWN	1162014	GREY	500	10.5	6	0.8	0.25	2.0	0.25	TRAP24-10 OR SQ28-10
0.14*		1181014		1183014		1182014			12.5	8	0.8	0.25	2.0	0.25	
0.25*	24	1161025	YELLOW	1163025	VIOLET	1162025	BLUE	500	10.5	6	0.8	0.25	2.0	0.25	
0.25*		1181025		1183025		1182025			12.5	8	0.8	0.25	2.0	0.25	
0.34*	24	1161034	TURQUOISE	1163034	PINK	1162034	TURQUOISE	500	10.5	6	0.8	0.25	2.0	0.25	
0.34*		1181034		1183034		1182034			12.5	8	0.8	0.25	2.0	0.25	
0.50	20	1161050	WHITE	1163050	WHITE	1162050	ORANGE	500	11.5	6	1.1	0.15	2.5	0.25	
0.50		1181050		1183050		1182050			13.5	8	1.1	0.15	2.5	0.25	
0.50		11101050		11103050		11102050			15.5	10	1.1	0.15	2.5	0.25	
0.75	20	1161075	GREY	1163075	BLUE	1162075	WHITE	500	12.0	6	1.3	0.15	2.8	0.25	
0.75		1181075		1183075		1182075			14.0	8	1.3	0.15	2.8	0.25	
0.75		11101075		11103075		11102075			16.0	10	1.3	0.15	2.8	0.25	
0.75		11121075		11123075		11122075			18.0	12	1.3	0.15	2.8	0.25	
1.00	18	1161010	RED	1163010	RED	1162010	YELLOW	500	12.5	6	1.5	0.15	3.0	0.3	
1.00		1181010		1183010		1182010			14.5	8	1.5	0.15	3.0	0.3	
1.00		11101010		11103010		11102010			16.5	10	1.5	0.15	3.0	0.3	
1.00		11121010		11123010		11122010			18.5	12	1.5	0.15	3.0	0.3	
1.50*	16	1161015	BLACK	1163015	BLACK	1162015	RED	500	12.5	6	1.8	0.15	3.4	0.3	
1.50		1181015		1183015		1182015			14.5	8	1.8	0.15	3.4	0.3	
1.50		11101015		11103015		11102015			16.5	10	1.8	0.15	3.4	0.3	
1.50		11121015		11123015		11122015			18.5	12	1.8	0.15	3.4	0.3	
1.50		11181015		11183015		11182015			24.5	18	1.8	0.15	3.4	0.3	
2.08*	14	1181208	YELLOW	1183208	YELLOW	1182208	YELLOW	500	14.5	8	2.05	0.15	3.6	0.3	
2.50	14	1181025	BLUE	1183025	GREY	1182025	BLUE	500	15.0	8	2.3	0.15	4.2	0.3	
2.50		11121025		11123025		11122025			19.0	12	2.3	0.15	4.2	0.3	
2.50		11181025		11183025		11182025			25.0	18	2.3	0.15	4.2	0.3	
4.00	12	11101040	GREY	11103040	ORANGE	11102040	GREY	500	17.5	10	2.9	0.2	4.8	0.3	
4.00		11121040		11123040		11122040			20.0	12	2.9	0.2	4.8	0.3	
4.00		11181040		11183040		11182040		100	26.0	18	2.9	0.2	4.8	0.3	
6.00	10	11121060	YELLOW	11123060	GREEN	11122060	BLACK	100	20.0	12	3.6	0.2	6.2	0.3	TRAP8-1 OR TRAP8-4
6.00		11181060		11183060		11182060			25.0	18	3.6	0.2	6.2	0.3	
10.00	8	11121100	RED	11123100	BROWN	11122100	IVORY	100	21.0	12	4.6	0.2	7.5	0.3	
10.00		11181100		11183100		11182100			27.0	18	4.6	0.2	7.5	0.3	
16.00	6	11121160	BLUE	11123160	WHITE	11122160	GREEN	100	23.0	12	6.0	0.2	8.8	0.4	
16.00		11181160		11183160		11182160			29.0	18	6.0	0.2	8.8	0.4	

\* DOES NOT CONFORM TO DIN 46228 PART 4



SIZE MM <sup>2</sup>	AWG	DIN PART NO.	COLOR CODE DIN	T PART NO.	COLOR CODE T	W PART NO.	COLOR CODE W	PIECES PER BAG	DIMENSIONS (MM)						REC. CRIMPING TOOL
									L-1	L-2	D-1	S-1	D-2	S-2	
25.00	4	11161250	YELLOW	11163250	BLACK	11162250	BROWN	50	29.0	16	7.5	0.2	11.0	0.5	TRAP8-1 OR TRAP8-4
25.00		11181250		11183250		11182250			31.0	18	7.5	0.2	11.0	0.5	
25.00		11221250		11223250		11222250			35.0	22	7.5	0.2	11.0	0.5	
35.00	2	11161350	RED	11163350	RED	11162350	BEIGE	50	30.0	16	8.5	0.2	12.5	0.5	TRAP8-1
35.00		11181350		11183350		11182350			32.0	18	8.5	0.2	12.5	0.5	
35.00		11251350		11253350		11252350			39.0	25	8.5	0.2	12.5	0.5	
50.00	1	11201500	BLUE	11203500	BLUE	11202500	OLIVE	50	36.0	20	10.5	0.35	15.0	0.6	
50.00		11251500		11253500		11252500		25	41.0	25	10.5	0.35	15.0	0.6	
70.00*	1/0	11201700	YELLOW	11203700	YELLOW	11202700	YELLOW	25	37.0	20	12.7	0.35	16.0	0.6	VICE70150
70.00*	2/0	11271700		11273700		11272700			43.0	27	12.7	0.40	16.0	0.6	
95.00*	3/0	11251950	RED	11253950	RED	11252950	RED	25	44.0	25	14.7	0.35	18.0	0.6	
120.00*	4/0	112711200	BLUE	112731200	BLUE	112721200	BLUE	25	48.0	27	16.7	0.45	21.0	0.7	
150.00*	300 MCM	113211500	YELLOW	113231500	YELLOW	113221500	YELLOW	25	58.0	32	19.5	0.5	23.0	1.0	

## WIRE FERRULES INSULATED FOR THICK INSULATION



SIZE MM <sup>2</sup>	AWG	DIN PART NO.	COLOR CODE DIN	T PART NO.	COLOR CODE T	W PART NO.	COLOR CODE W	PIECES PER BAG	DIMENSIONS (MM)					
									L-1	L-2	D-1	S-1	D-2	S-2
0.50	22	1050G	WHITE	3050G	WHITE	2050G	ORANGE	500	13.5	8	1.1	0.15	3.0	0.25
0.75	20	1075G	GREY	3075G	BLUE	2075G	WHITE	500	14.0	8	1.3	0.15	3.4	0.3
1.00	18	1100G	RED	3100G	RED	2100G	YELLOW	500	14.0	8	1.5	0.15	3.4	0.3
1.50	16	1150G	BLACK	3150G	BLACK	2150G	RED	500	14.0	8	1.8	0.15	3.8	0.3
16.00	14	1160G	WHITE	3160G	WHITE	2160G	GREEN	100	23.0	12	6.0	0.2	9.5	0.4

\* DOES NOT CONFORM TO DIN 46228 PART 4

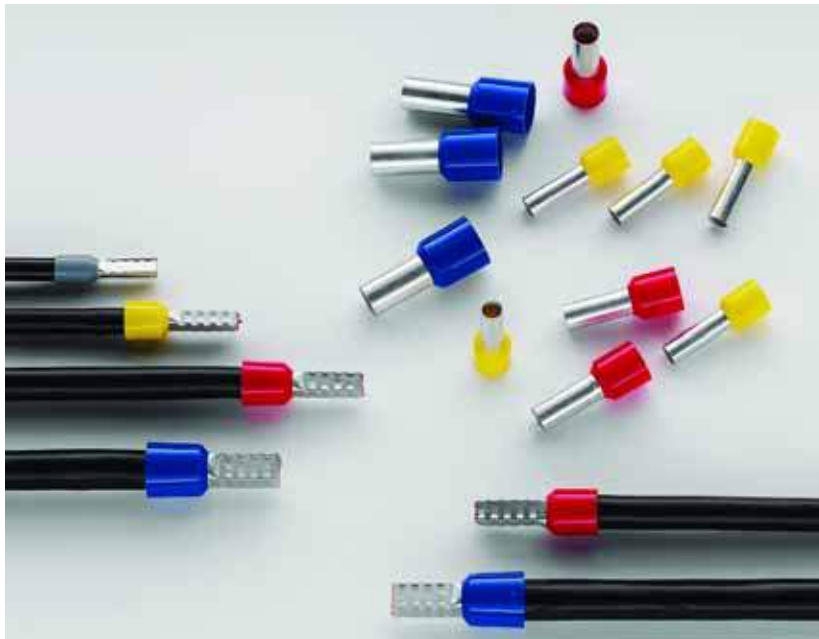



## WIRE FERRULES ON STRIPS



SIZE MM <sup>2</sup>	BARREL LENGTH (MM)		DIN PART NO.	COLOR CODE DIN	T PART NO.	COLOR CODE T	C PART NO.	COLOR CODE W	PIECES
0.50	22	8	101050	WHITE	103050	WHITE	102050	ORANGE	10 x 50
0.75	20	8	101075	GREY	103075	BLUE	102075	WHITE	10 x 50
1.00	18	8	101100	RED	103100	RED	102100	YELLOW	10 x 50
1.50	16	8	101150	BLACK	103150	BLACK	102150	RED	10 x 50
2.50	14	8	101250	BLUE	103250	GREY	102250	BLUE	10 x 50

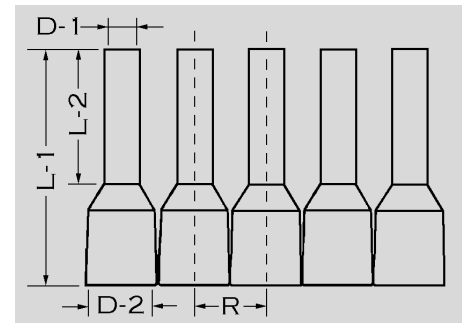

MATERIAL: COPPER / PLASTIC  
SURFACE: TIN PLATED

## WIRE FERRULES ON REELS

ALSO USED WITH MC 25

SIZE MM <sup>2</sup>	LENGTH MM	PART NO.	COLOR CODE DIN	PART NO.	COLOR CODE T	PART NO.	COLOR CODE W	PIECES PER BOX
0.50	8	MC1050	WHITE	MC3050	WHITE	MC2050	ORANGE	1000
0.75	8	MC1075	GREY	MC3075	BLUE	MC2075	WHITE	1000
1.00	8	MC1100	RED	MC3100	RED	MC2100	YELLOW	1000
1.50	8	MC1150	BLACK	MC3150	BLACK	MC2150	RED	1000
2.50	8	MC1250	BLUE	MC3250	GREY	MC2250	BLUE	500



## TWIN-WIRE FERRULES FOR TWO WIRES

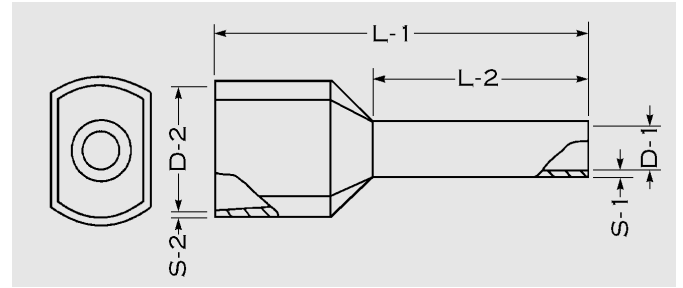

**MATERIAL:** COPPER / PLASTIC  
**SURFACE:** TIN PLATED



SIZE MM <sup>2</sup>	AWG	DIN PART No.	COLOR CODE DIN	W PART No.	COLOR CODE W	PCS. PER BAG	DIMENSIONS (MM)						REC. CRIMPING TOOL
							L-1	L-2	D-1	S-1	D-2	S-2	
2 X 0.50	20	1381050	WHITE	1382050	ORANGE	500	15.0	8.0	1.5	0.15	2.3 / 4.5	0.25	SQ28-10 OR TRAP24-10
2 X 0.75	20	1381075	GREY	1382075	WHITE	500	15.0	8.0	1.8	0.15	2.6 / 5.1	0.25	
2 X 0.75	20	13101075		13102075		500	17.0	10.0	1.8	0.15	2.6 / 5.1	0.25	
2 X 1.00	18	1381010	RED	1382010	YELLOW	500	15.0	8.0	2.05	0.15	3.2 / 5.1	0.30	
2 X 1.00	18	13101010		13102010		500	17.0	10.0	2.05	0.15	3.2 / 5.1	0.30	
2 X 1.50	16	1381015	BLACK	1382015	RED	500	16.0	8.0	2.3	0.15	3.5 / 6.4	0.30	
2 X 1.50	16	13121015		13122015		500	20.0	12.0	2.3	0.15	3.5 / 6.4	0.30	
2 X 2.50	14	13101025	BLUE	13102025	BLUE	100	18.5	10.0	2.9	0.20	4.0 / 7.5	0.30	
2 X 2.50	14	13131025		13132025		100	21.5	13.0	2.9	0.20	4.0 / 7.5	0.30	
2 X 4.00	12	13121040	GREY	13122040	GREY	100	23.0	12.0	3.8	0.20	4.9 / 8.6	0.30	
2 X 6.00	10	13141060	YELLOW	13142060	BLACK	100	25.0	14.0	4.9	0.20	5.8 / 9.6	0.40	
2 X 10.0	8	13141100	RED	13142100	IVORY	100	26.0	14.0	6.5	0.20	6	0.40	TRAP8-1 OR TRAP8-4
2 X 16.0	6	13161160	BLUE	13162160	GREEN	50	31.0	16.0	8.5	0.20	6	0.50	

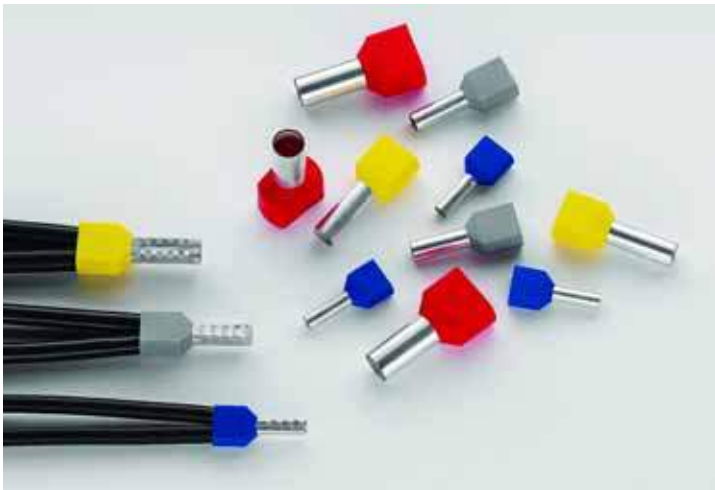



## WIRE FERRULES NON-INSULATED

DIN 46228 PART 1

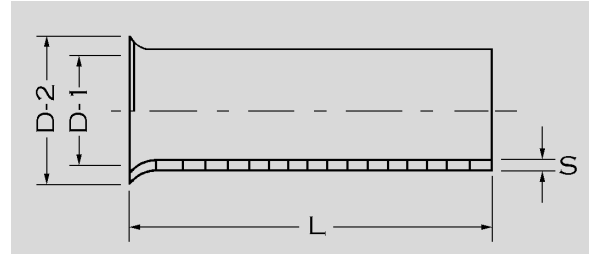

MATERIAL: COPPER  
SURFACE: TIN PLATED



SIZE MM <sup>2</sup>		PART NO.	PCS. PER BAG	DIMENSIONS (MM)				REC. CRIMPING TOOL			
				L	D-1	D-2	S				
0.25	24	12510025*	1000	5	0.8	1.7	0.15	SQ28-10 OR TRAP24-10			
		12710025*		7							
0.34	22	12510034*	1000	5	0.9	1.8	0.15		SQ28-10 OR TRAP24-10		
		12710034*		7							
0.50	20	12610050	1000	6	1.0	2.1	0.15			SQ28-10 OR TRAP24-10	
		12810050*		8							
		121010050		10							
0.75	20	12610075	1000	6	1.2	2.3	0.15				SQ28-10 OR TRAP24-10
		12810075*		8							
		121010075		10							
		121210075		12							
1.00	18	12610100	1000	6	1.4	2.5	0.15	SQ28-10 OR TRAP24-10			
		12810100*		8							
		121010100		10							
		121210100*		12							
1.50	16	12710150	1000	7	1.7	2.8	0.15		SQ28-10 OR TRAP24-10		
		121010150		10							
		121210150		12							
		121510150*		15							
		121810150		18							
		122010150*		20							
2.50	14	12710250	1000	7	2.2	3.4	0.15	SQ28-10 OR TRAP24-10			
		121010250		10							
		121210250		12							
		121510250*		15							
		121810250		18							
		122010250*		20							
4.00	12	12910400	1000	9	2.8	4.0	0.2		SQ28-10 OR TRAP24-10		
		121010400		10							
		121210400		12							
		121510400		15							
		121810400		18							
		122010400*		20							

SIZE MM <sup>2</sup>	AWG	PART NO.	PCS. PER BAG	DIMENSIONS (MM)				REC. CRIMPING TOOL
				L	D-1	D-2	S	
6.00	10	121010600	1000	10	3.5	4.7	0.2	SQ28-10 OR TRAP24-10
		121210600		12				
		121510600		15				
		121810600		18				
10.00	8	1212110	500	12	4.5	5.8	0.2	TRAP8-1 OR TRAP8-4
		1215110		15				
		1218110		18				
		1220110*		20				
16.00	6	1225110*	250	25	5.8	7.5	0.2	TRAP8-1 OR TRAP8-4
		1212116		12				
		1215116		15				
		1218116		18				
25.00	4	1220116*	250	20	5.8	7.5	0.2	TRAP8-1 OR TRAP8-4
		1225116		25				
		1232116		32				
		1212125*		12				
35.00	2	1215125	100	15	7.3	9.5	0.2	TRAP8-1 OR TRAP8-4
		1218125		18				
		1225125		25				
		1232125		32				
50.00	1	1218135	100	18	8.3	11	0.2	TRAP8-1 OR TRAP8-4
		1220135*		20				
		1225135		25				
		1232135		32				
70.00	2/0	1218150	100	18	10.3	13	0.3	TRAP8-1 OR TRAP8-4
		1222150*		22				
		1225150		25				
		1232150		32				
70.00	2/0	1225170	100	25	12.5	15	0.4	VICE70150
		1232170*		32				

\* DOES NOT CONFORM TO DIN 46228 PART 1



SIZE MM <sup>2</sup>	AWG	PART NO.	PCS. PER BAG	DIMENSIONS (MM)				REC. CRIMPING TOOL
				L	D-1	D-2	S	
95.0	3/0	1225195*	100	25	14.5	17	0.4	VICE70150
		30						
		32						
120.0	4/0	12321120*	100	32	16.5	19	0.5	
		40						
150.0	300	123211500*	100	32	18.5	21	0.5	
	MCM	123811500*		38				
185.0	350	123211850*	100	32	20	23.5	0.6	
	MCM	124011850*		40				





## ASSORTMENT BOXES

INSULATED FERRULES	SIZE MM <sup>2</sup>	AWG	BARREL LENGTH	QUANTITY	PART NUMBER	DIN	PART DIN	T	PART T	W
						COLOR CODE		COLOR CODE NUMBER		COLOR CODE W
ASSORTMENT	0.25	26	6	30	<b>161025</b>	YELLOW	<b>163025</b>	VIOLET	<b>162025</b>	BLUE
Box 1	0.34	24	6	30		TURQ		PINK		TURQ
	0.50	22	8	30		WHITE		WHITE		ORANGE
	0.75	20	8	30		GREY		BLUE		WHITE
	1.00	18	8	30		RED		RED		YELLOW
ASSORTMENT	0.50	22	8	50	<b>161050</b>	WHITE	<b>163050</b>	WHITE	<b>162050</b>	ORANGE
Box 2	0.75	20	8	100		GREY		BLUE		WHITE
	1.00	18	8	100		RED		RED		YELLOW
	1.50	16	8	100		BLACK		BLACK		RED
	2.50	14	8	50		BLUE		GREY		BLUE
ASSORTMENT	4.00	12	10	50	<b>16140</b>	GREY	<b>16340</b>	ORANGE	<b>16240</b>	GREY
Box 3	6.00	10	12	20		YELLOW		GREEN		BLACK
	10.00	8	12	20		RED		BROWN		IVORY
	16.00	6	12	10		BLUE		WHITE		GREEN
ASSORTMENT	0.50	22	8	50	<b>16050T</b>	WHITE				
Box 4	0.75	20	8	50		GREY				
TWIN	1.00	18	8	50		RED				
	1.50	16	8	50		BLACK				
ASSORTMENT	0.75	20	8	50	<b>16075T</b>	WHITE				
Box 5	1.00	18	8	50		GREY				
TWIN	1.50	16	8	50		RED				
	2.50	14	10	50		BLACK				
ASSORTMENT	1.50	16	8	30	<b>16150T</b>	BLACK				
Box 6	2.50	14	10	30		BLUE				
TWIN	4.00	12	12	20		GREY				
	6.00	10	14	10		YELLOW				
ASSORTMENT	0.50	22	6	500	<b>16050U</b>					
Box 7	0.75	20	6	400						
NONINSULATED	1.00	18	6	400						
	1.50	16	7	300						
	2.50	14	7	200						
ASSORTMENT	1.50	16	9	150	<b>16040U</b>					
Box 8	2.50	14	10	100						
NONINSULATED	4.00	12	12	80						
	6.00	10	12	40						
ASSORTMENT					<b>165</b>					
BOX EMPTY										
5 DIVISIONS										
ASSORTMENT					<b>164</b>					
BOX EMPTY										
4 DIVISIONS										
ASSORTMENT					<b>160</b>					
BOX EMPTY										
W/O DIVISIONS										

## CRIMP KIT



### FEATURES

CONVENIENT AND PORTABLE METAL CARRYING CASE  
 INSULATED FERRULES  
 FERRULE ASSORTMENT FROM 24 - 10 AWG  
 STRIPPING AND CRIMPING TOOL INCLUDED  
 GREAT FOR TECHNICIANS AND PROTOTYPING

## SLIDE BOXES



### FEATURES

HANDY, CONVENIENT  
 NO MIXING OF CONTENTS  
 FIVE COMPARTMENTS  
 INSULATED FERRULE ASSORTMENTS

SIZE MM <sup>2</sup>	AWG	BARREL LENGTH	QUANTITY	PART NUMBER	DIN COLOR CODE DIN	PART NUMBER	W COLOR CODE W
<b>SINGLE FERRULE ASSORTMENTS</b>							
0.50	22	8	50	<b>1617050</b>	WHITE	<b>1627050</b>	ORANGE
0.75	20	8	100		GREY		WHITE
1.00	18	8	100		RED		YELLOW
1.50	16	8	100		BLACK		RED
2.50	14	8	50		BLUE		BLUE
4.00	12	10	50	<b>1617400</b>	GREY	<b>1627400</b>	GREY
6.00	10	12	20		YELLOW		BLACK
10.00	8	12	20		RED		BEIGE
16.00	6	12	10		BLUE		GREEN
<b>TWIN FERRULE ASSORTMENTS</b>							
2 x 0.50	22	8	50	<b>1617050T</b>	WHITE	<b>1627050T</b>	ORANGE
2 x 0.75	20	8	50		GREY		WHITE
2 x 1.00	18	8	50		RED		YELLOW
2 x 1.50	16	8	50		BLACK		RED
2 x 2.50	14	10	25		BLUE		BLUE



# WIRE FERRULE CROSS REFERENCE

## ALTECH

PART #	Pcs./BAG	MM	AWG
22010	500/100	0.5	20
22020	500/100	0.75	20
22030	500/100	1	18
22040	500/100	1.5	16
22100	100	6	10
22110	100	6	10
22120	100	10	8
22130	100	10	8
22140	100	16	6
22150	100	16	6
22670	50	25	4
22760	50	35	2
23430	500/100	1.5	16
23900	50	35	2
23970	500/100	0.5	20
23980	500/100	0.75	20
23990	500/100	1	18
24000	500/100	1.5	16
24010	500/100	2.5	14
24020	500/100	4	12
25000	50	50	1
26200	500/100	0.25	24
26210	500/100	0.25	24
26220	500/100	0.34	24
26230	500/100	0.34	24
27860	25	70	1/0
27860	25	70	1/0
27870	25	95	3/0
27880	25	120	4/0
27890	25	150	300 MCM
28360	500/100	0.5	20
28400	500/100	1	18
28410	500/100	1.5	16
28420	500/100	1.5	16
28430	500/100	1.5	16
28440	500/100	1.5	16
28450	500/100	2.5	14
28450	500/100	2.5	14
28460	500/100	2.5	14
28470	500/100	2.5	14
28480	500/100	4	12
28490	500/100	4	12
28500	100	4	12
28510	100	6	10
28520	100	6	10
28530	100	10	8
28540	100	10	8
28550	100	16	6
28560	100	16	6
28570	50	25	4
28580	50	25	4
28590	50	35	2
28600	50	25	4
28610	50	50	1
28640	500/100	0.5	20
28650	500/100	0.5	20
28660	500/100	0.75	20
28670	500/100	0.75	20
28680	500/100	0.75	20
28690	500/100	0.75	20
28700	500/100	1	18
28710	500/100	1	18
28720	500/100	1	18

## AMERICAN ELECTRICAL

PART #	COLOR	Pcs./BAG
1182050	ORANGE	500
1182075	WHITE	500
1182010	YELLOW	500
1182015	RED	500
11122060	BLACK	100
11182060	BLACK	100
11122100	IVORY	100
11182100	IVORY	100
11122160	GREEN	100
11182160	GREEN	100
11182250	BROWN	50
11182350	BEIGE	50
11183015	BLACK	500
11252350	BEIGE	50
1162050	ORANGE	500
1162075	WHITE	500
1162010	YELLOW	500
11102015	RED	500
11122025	BLUE	500
11122040	GREY	500
11202500	OLIVE	50
11610025	YELLOW	500
11820025	BLUE	500
1161034	TURQ	500
1181034	TURQ	500
11201700	YELLOW	25
11202700	YELLOW	25
11251950	RED	25
112711200	BLUE	25
113211500	YELLOW	25
1161050	WHITE	500
11123010	RED	500
1181015	BLACK	500
11103015	BLACK	500
11121015	BLACK	500
11181015	BLACK	500
1181025	BLUE	500
1182025	BLUE	500
11121025	BLUE	500
11181025	BLUE	500
11101040	GREY	500
11121040	GREY	500
11181040	GREY	100
11121060	YELLOW	100
11181060	YELLOW	100
11121100	RED	100
11181100	RED	100
11121160	BLUE	100
11181160	BLUE	100
11181250	YELLOW	50
11221250	YELLOW	50
11183350	RED	50
11253350	RED	50
11201500	BLUE	50
1181050	WHITE	500
11101050	WHITE	500
1161075	GREY	500
1181075	GREY	500
11101075	GREY	500
11121075	GREY	500
1161010	RED	500
1181010	RED	500
11101010	RED	500

## ALTECH

PART #	Pcs./BAG	MM	AWG
27750	500/100	2 x 0.75	20
27760	500/100	2 x 1.00	18
27770	500/100	2 x 1.50	16
27780	250/100	2 x 2.50	14
27940	500/100	2 x 0.50	20
27950	500/100	2 x 0.75	20
27960	500/100	2 x 1.00	18
27970	500/100	2 x 1.50	16
27980	250/100	2 x 2.50	14
27990	100	2 x 4.00	12
28000	100	2 x 6.00	10
28010	100	2 x 10.0	8
28020	100/50	2 x 16.0	6
22160	1000/100	0.5	20
22170	1000/100	0.75	20
22180	1000/100	0.75	20
22190	1000/100	1	18
22200	1000/100	1	18
22210	1000/100	1.5	16
22220	1000/100	1.5	16
22230	1000/100	2.5	14
22240	1000/100	2.5	14
22250	1000/100	4	12
22250	1000	4	12
22260	1000/100	4	12
22270	1000/100	6	10
22280	1000/100	10	8
22290	1000/100	10	8
23880	1000/100	6	10
23890	500/100	10	8
23910	500/100	16	6
23920	500/100	16	6
23930	500/100	16	6
23940	500/100	25	4
23950	500/100	25	4
23960	500/100	35	2
27910	50	95	3/0
27920	50	120	4/0
27930	50	150	300 MCM
28150	25	185	350 MCM
28160	100	50	1

## AMERICAN ELECTRICAL

PART #	COLOR	Pcs./BAG
1381075	GREY	500
1381010	RED	500
1381015	BLACK	500
13101025	BLUE	500
1381050	WHITE	500
13101075	GREY	500
13101010	RED	500
13121015	BLACK	500
13131025	BLUE	500
13121040	GREY	100
13141060	YELLOW	100
13141100	RED	100
13161160	BLUE	50
12610050		1000
12610075		1000
121010075		1000
12610100		1000
121010100		1000
12710150		1000
121010150		1000
12710250		1000
121210250		1000
12910400		1000
121010400		1000
121210400		1000
121210600		1000
1212110		500
1218110		500
121510600		1000
1215110		500
1212116		250
1215116		250
1218116		250
1215125		100
1218125		100
1218135		100
1230195		100
12321120		100
123811500		100
124011850		100
1232150		100

ENTRELEC

AMERICAN ELECTRICAL

MIRO

AMERICAN ELECTRICAL

PART #	Pcs./BAG	MM	AWG	PART #	COLOR	Pcs./BAG	PART #	Pcs./BAG	MM	AWG	PART #	COLOR	Pcs./BAG
30445400	1000	0.5	20	1181050	WHITE	500	G1201		50	1	11202500	OLIVE	50
30445501	1000	0.75	20	1181075	GREY	500	G1202		35	2	11162350	BEIGE	50
30445602	1000	1	18	1181010	RED	500	G1204		25	4	11162250	BROWN	50
30445703	1000	1.5	16	1181015	BLACK	500	G1206		16	6	11122160	GREEN	100
30445814	1000	1.5	16	11181015	BLACK	500	G1208		10	8	11122100	IVORY	100
30445915	1000	2.5	14	1181025	BLUE	500	G1210		6	10	11122060	BLACK	100
30446012	1000	2.5	14	11181025	BLUE	500	G1212		4	12	11102040	GREY	500
30446107	1000	4	12	11101040	GREY	500	G1214		2.5	14	1182025	BLUE	500
30446200	1000	4	12	11181040	GREY	100	G1216		1.5	16	1182015	RED	500
30446301	100	6	10	11121060	YELLOW	100	G1218		1	18	1182010	YELLOW	500
30446402	100	6	10	11181060	YELLOW	100	G1220		0.75	20	1182075	WHITE	500
30446503	100	10	8	11121100	RED	100	G1222		0.5	22	1182050	ORANGE	500
30446604	100	10	8	11181100	RED	100	G1224		0.34	24	1181034	TURQ	500
30446705	100	16	6	11121160	BLUE	100	G1228		0.25	26	11620025	BLUE	500
30446816	100	16	6	11181160	BLUE	100	G2201		50	1	11252500	OLIVE	25
30446917	100	25	4	11181250	YELLOW	50	G2202		35	2	11252350	IVORY	50
30447014	50	35	2	11181350	RED	50	G2204		25	4	11222250	BROWN	50
30447101	50	50	1	11251500	BLUE	25	G2206		16	6	11182160	GREEN	100
30455810		2 x 0.50	20	1381050	WHITE	500	G2208		10	8	11182100	IVORY	100
30455911		2 x 0.75	20	1381075	GREY	500	G2210		6	10	11182060	BLACK	100
30456016		2 x 0.75	20	13101075	GREY	500	G2212		4	12	11182040	GREY	100
30456103		2 x 1.00	18	1381010	RED	500	G2214		2.5	14	11182025	BLUE	500
30456204		2 x 1.00	18	13101010	RED	500	G2216		1.5	16	11182015	RED	500
30456305		2 x 1.50	16	1381015	BLACK	500	G2218		1	18	11122010	YELLOW	500
30456406		2 x 1.50	16	13121015	BLACK	500	G2220		0.75	20	11102075	WHITE	500
30456507		2 x 2.50	14	13101025	BLUE	500	G2222		0.5	22	11102050	ORANGE	500
30456600		2 x 2.50	14	13131025	BLUE	500	G2224		0.34	24	1181034	TURQ	500
30456701		2 x 4.00	12	13121040	GREY	100	G2228		0.25	26	11820025	BLUE	500
30456812		2 x 6.00	10	13141060	YELLOW	100							
30456913		2 x 10.0	8	13141100	RED	100	U1222		0.5	20	12610050		1000
30457010		2 x 16.0	6	13161160	BLUE	50	U1220		0.75	20	12610075		1000
							U1218		1	18	12810100		1000
30457105		0.5	20	12610050		1000	U1216		1.5	16	12710150		1000
30457206		0.75	20	12610075		1000	U1214		2.5	14	12710250		1000
30457307		1	18	12610100		1000	U2222		0.5	20	12810050		1000
30457400		1	18	121010100		1000	U2220		0.75	20	12810075		1000
30457501		1.5	16	12710150		1000	U1212		4	12	12910400		1000
30457602		1.5	16	121010150		1000	U2218		1	18	121010100		1000
30457703		2.5	14	12710250		1000	U2216		1.5	16	121010150		1000
30457814		2.5	14	121210250		1000	U2214		2.5	14	121010250		1000
30457915		4	12	12910400		1000	U2212		4	12	121210400		1000
30458003		4	12	121210400		1000	U1210		6	10	121210600		1000
30458120		6	10	121010600		1000	U2210		6	10	121510600		1000
30458221		6	10	121210600		1000	U1208		10	8	1215110		500
30458322		6	10	121510600		1000	U1206		16	6	1215116		250
30458423		10	8	1212110		500	U1204		25	4	1212125		100
30458524		10	8	1215110		500	U2208		10	8	1218110		500
30458625		10	8	1218110		500							
30458726		16	6	1212116		250							
30458807		16	6	1215116		250							
30458900		16	6	1218116		250							



## WIRE FERRULE CROSS REFERENCE

### PHOENIX

### AMERICAN ELECTRICAL

### PHOENIX

### AMERICAN ELECTRICAL

PART #	PCS./BAG	MM	AWG	PART #	COLOR	PCS./BAG
3009215	100	0.34	24	1161034	TURQ	500
3200014	100	0.5	20	1181050	WHITE	500
3200027	100	0.75	20	1183075	BLUE	500
3200030	100	1	18	1181010	RED	500
3200043	100	1.5	16	1181015	BLACK	500
3200056	100	1.5	16	11181015	BLACK	500
3200069	100	2.5	14	1183025	GREY	500
3200072	100	2.5	14	11183025	GREY	500
3200085	100	4	12	11103040	ORANGE	500
3200098	100	4	12	11183040	ORANGE	100
3200108	100	6	10	11123060	GREEN	100
3200111	100	6	10	11183060	GREEN	100
3200124	100	10	8	11123100	BROWN	100
3200137	100	10	8	11183100	BROWN	100
3200179	100	0.25	24	11610025	YELLOW	500
3200182	100	1	18	11103010	RED	500
3200195	100	1.5	16	11103015	BLACK	500
3200205	100	2.5	14	11123025	GREY	500
3200412	100	25	4	11163250	BLACK	50
3200438	100	4	12	11123040	ORANGE	500
3200441	100	35	2	11161350	RED	50
3200454	100	50	1	11201500	BLUE	50
3200519	100	0.75	20	1181075	GREY	500
3200522	100	2.5	14	1181025	BLUE	500
3200535	100	4	12	11101040	GREY	500
3200548	100	6	10	11121060	YELLOW	100
3200551	100	10	8	11121100	RED	100
3200564	100	16	6	11121160	BLUE	100
3200577	100	25	4	11161250	YELLOW	50
3200580	100	2.5	14	11181025	BLUE	500
3200593	100	4	12	11181040	GREY	100
3200603	100	6	10	11181060	YELLOW	100
3200616	100	10	8	11181100	RED	100
3200629	100	16	6	11181160	BLUE	100
3200632	100	0.25	24	11820025	BLUE	500
3200674	100	1	18	11123010	RED	500
3200687	100	0.5	20	1163050	WHITE	500
3200713	100	35	2	11253350	RED	50
3200726	100	50	1	11253500	BLUE	25
3200739	100	35	2	11252350	BEIGE	50
3200742	100	1	18	1163010	RED	500
3200755	100	1.5	16	1163015	BLACK	500
3200865	100	0.34	24	1182034	TURQ	500
3200881	1000	0.5	20	1183050	WHITE	500
3200904	1000	1	18	1183010	RED	500
3200917	1000	1.5	16	1183015	BLACK	500
3200920	1000	2.5	14	1182025	BLUE	500
3200959	100	4	12	11122040	GREY	500
3200962	100	2.5	14	11122025	BLUE	500
3201068	100	10	8	11122100	IVORY	100
3201071	100	35	2	11162350	BEIGE	50
3201084	100	25	4	11162250	BROWN	50
3201097	100	1	18	1182010	YELLOW	500
3201107	100	6	10	11122060	BLACK	100
3201110	100	0.75	20	1182075	WHITE	500
3201136	100	1.5	16	1182015	RED	500
3201152	100	16	6	11122160	GREEN	100
3201178	100	50	1	11202500	OLIVE	50
3201181	100	16	6	11123160	WHITE	100
3201275	100	0.5	20	11103050	WHITE	500
3201291	100	0.25	24	11620025	BLUE	500
3201301	100	0.5	20	1162050	ORANGE	500
3201301	100	0.5	20	1182050	ORANGE	500
3201314	100	0.75	20	1162075	WHITE	500
3201327	100	1	18	1162010	YELLOW	500
3201330	100	16	6	11182160	GREEN	100

PART #	PCS./BAG	MM	AWG	PART #	COLOR	PCS./BAG
3009202	1000	0.34	22	12710034		1000
3200218	1000	0.5	20	12610050		1000
3200221	1000	0.75	20	12610075		1000
3200234	1000	0.75	20	121010075		1000
3200247	1000	1	18	12610100		1000
3200250	1000	1	18	121010100		1000
3200263	1000	1.5	16	12710150		1000
3200276	1000	1.5	16	121010150		1000
3200289	1000	2.5	14	12710250		1000
3200292	1000	2.5	14	121210250		1000
3200302	1000	4	12	12910400		1000
3200315	1000	4	12	121210400		1000
3200328	500	6	10	121210600		1000
3200836	100	2.5	14	13101025		500
3200878	100	2.5	14	13131025		500
3200975	100	0.75	20	13101075		500
3200988	100	1	18	13101010		500
3200991	100	1.5	16	13121015		500
3201000	100	4	12	13121040		100
3201013	100	4	12	13141060		100
3201026	100	10	8	13141100		100



WAGO

AMERICAN ELECTRICAL

PART #	PCS./BAG	MM	AWG	PART #	COLOR	PCS./BAG
		0.14	26	<b>1161014</b>	GREY	500
		0.14	26	<b>1181014</b>	GREY	500
216201	1000	0.5	22	<b>1181050</b>	WHITE	500
216203	1000	1	18	<b>1181010</b>	RED	500
216204	1000	1.5	16	<b>1181015</b>	BLACK	500
216205	1000	2.1	14	<b>1181208</b>	YELLOW	500
216206	1000	2.5	14	<b>1183025</b>	GREY	500
216207	1000	4	12	<b>11103040</b>	ORANGE	500
216208	100	6	10	<b>11123060</b>	GREEN	100
216209	100	10	8	<b>11123100</b>	BROWN	100
216210	100	16	6	<b>11123160</b>	WHITE	100
216221	1000	0.5	22	<b>1161050</b>	WHITE	500
216222	1000	0.75	20	<b>1163075</b>	BLUE	500
216223	1000	1	18	<b>1161010</b>	RED	500
216224	1000	1.5	16	<b>1161015</b>	BLACK	500
216301	1000	0.25	24	<b>11810025</b>	YELLOW	500
216302	1000	0.34	24	<b>1181034</b>	TURQ	500
216321	1000	0.25	24	<b>11610025</b>	YELLOW	500
216322	1000	0.34	24	<b>1161034</b>	TURQ	500
2162020	1000	0.75	20	<b>1181075</b>	BLUE	500
216101	1000	0.5	22	<b>12810050</b>		1000
216102	1000	0.75	20	<b>12810075</b>		1000
216103	1000	1	18	<b>12810100</b>		1000
216104	1000	1.5	16	<b>12810150</b>		1000
216106	1000	2.5	14	<b>121010250</b>		1000
216107	1000	4	12	<b>12910400</b>		1000
216108	250	6	10	<b>121210600</b>		1000
216109	250	10	8	<b>1212110</b>		500
216110	250	16	6	<b>1215116</b>		500
216121	1000	0.5	22	<b>12610050</b>		1000
216122	1000	0.75	20	<b>12610075</b>		1000
216123	1000	1	18	<b>12610100</b>		1000
216124	1000	1.5	16	<b>12710150*</b>		1000
216131	1000	0.25	24	<b>12710025</b>		1000
216132	1000	0.34	24	<b>12710034</b>		1000
216151	1000	0.25	24	<b>12510025</b>		1000
216152	1000	0.34	24	<b>12510034</b>		1000



# WIRE FERRULE CROSS REFERENCE

## WEIDMULLER

## AMERICAN ELECTRICAL

## WEIDMULLER

## AMERICAN ELECTRICAL

PART #	PCS./BAG	MM	AWG	PART #	COLOR	PCS./BAG	PART #	PCS./BAG	MM	AWG	PART #	COLOR	PCS./BAG
0317000000	50	25	4	11162250	BROWN	50	9021090000	500	2.5	14	11183025	GREY	500
0317100000	50	25	4	11222250	BROWN	50	9021100000	500	4	12	11103040	ORANGE	500
0317200000	50	35	2	11162350	BEIGE	50	9021110000	500	4	12	11123040	ORANGE	500
0317300000	50	35	2	11252350	BEIGE	50	9021120000	100	4	12	11183040	ORANGE	100
0409500000	500	0.5	20	1162050	ORANGE	500	9021130000	100	6	10	11123060	GREEN	100
0409600000	500	0.75	20	1162075	WHITE	500	9021140000	100	6	10	11183060	GREEN	100
0409700000	500	1	18	1162010	YELLOW	500	9021150000	100	10	8	11123100	BROWN	100
0444200000	50	50	1	11202500	OLIVE	50	9021160000	100	10	8	11183100	BROWN	100
0462900000	500	0.75	20	1182075	WHITE	500	9021170000	100	16	6	11123160	WHITE	100
0463000000	500	1	18	1182010	YELLOW	500	9021180000	100	16	6	11183160	WHITE	100
0463100000	500	1.5	16	1182015	RED	500	9021190000	50	25	4	11163250	BLACK	50
0533500000	100	6	10	11122060	BLACK	100	9021200000	50	25	4	11253250	BLACK	50
0534200000	100	10	8	11122100	IVORY	100	9025740000	500	0.25	24	11620025	BLUE	500
0565600000	500	1.5	16	11182015	RED	500	9025750000	500	0.34	24	1162034	TURQ	500
0565700000	100	6	10	11182060	BLACK	100	9025760000	500	0.25	24	11820025	BLUE	500
0565800000	100	10	8	11182100	IVORY	100	9025770000	500	0.34	24	1182034	TURQ	500
0565900000	100	16	6	11122160	GREEN	100	9025860000	500	0.75	20	11102075	WHITE	500
0566000000	100	16	6	11182160	GREEN	100	9025870000	500	0.5	20	11102050	ORANGE	500
0635100000	500	1.5	16	11102015	RED	500	9025910000	500	0.75	20	11122075	WHITE	500
0690700000	500	0.5	20	1182050	ORANGE	500	9025930000	500	1	18	11122010	YELLOW	500
9019000000	500	0.5	20	1161050	WHITE	500	9025950000	500	1	18	11102010	YELLOW	500
9019010000	500	0.5	20	1181050	WHITE	500	9028200000	25	70	1/0	11202700	YELLOW	25
9019020000	500	0.5	20	11101050	WHITE	500	9028210000	25	95	3/0	11252950	RED	25
9019030000	500	0.75	20	1161075	GREY	500	9028230000	25	150	300MCM	113221500	YELLOW	25
9019040000	500	0.75	20	1181075	GREY	500	9028250000	500	0.14	26	1163014	BROWN	500
9019050000	500	0.75	20	11101075	GREY	500							
9019060000	500	0.75	20	11121075	GREY	500	0124300000	500	16	6	1215116		250
9019070000	500	1	18	1161010	RED	500	0124400000	250	25	4	1215125		100
9019080000	500	1	18	1181010	RED	500	0124700000	500	6	10	121510600		1000
9019100000	500	1	18	11101010	RED	500	0124800000	500	10	8	1215110		500
9019110000	500	1	18	11121010	RED	500	0186100000	1000	2.5	14	121210250		1000
9019120000	500	1.5	16	1181015	BLACK	500	0186500000	1000	1.5	16	121010150		1000
9019130000	500	1.5	16	11101015	BLACK	500	0191900000	500	6	10	121210600		1000
9019140000	500	1.5	18	11121015	BLACK	500	0244100000	1000	4	12	121210400		1000
9019150000	500	1.5	16	11181015	BLACK	500	0282600000	1000	0.5	20	12610050		1000
9019160000	500	2.5	14	1181025	BLUE	500	0282700000	1000	0.75	20	12610075		1000
9019160000	500	2.5	14	1182025	BLUE	500	0282800000	1000	1	18	121010100		1000
9019170000	500	2.5	14	11121025	BLUE	500	0282900000	500	10	8	1212110		500
9019170000	500	2.5	14	11122025	BLUE	500	0368900000	100	35	2	1218135		100
9019180000	500	2.5	14	11181025	BLUE	500	3726000000	1000	1	18	12610100		1000
9019180000	500	2.5	14	11182025	BLUE	500	0372700000	1000	1.5	16	12710150		1000
9019190000	500	4	12	11101040	GREY	500	0373000000	1000	2.5	14	12710250		1000
9019190000	500	4	12	11102040	GREY	500	0373100000	500	4	12	12910400		1000
9019200000	500	4	12	11121040	GREY	500	0375200000	100	16	6	1218116		250
9019200000	500	4	12	11122040	GREY	500	0375300000	100	25	4	1218125		100
9019210000	500	4	12	11181040	GREY	500	0379300000	500	10	8	1218110		500
9019210000	500	4	12	11182040	GREY	500	0492500000	500	16	6	1212116		250
9019220000	100	6	10	11121060	YELLOW	100	0542500000	1000	0.75	20	121010075		1000
9019230000	100	6	10	11181060	YELLOW	100	9004050000	1000	0.5	20	121010050		1000
9019240000	100	10	8	11121100	RED	100	9004060000	1000	1.5	16	121210150		1000
9019250000	100	10	8	11181100	RED	100	9004070000	1000	1.5	16	121810150		1000
9019260000	100	16	6	11121160	BLUE	100	9004080000	1000	2.5	14	121010250		1000
9019270000	100	16	6	11181160	BLUE	100	9004090000	1000	2.5	14	121810250		1000
9019280000	50	25	4	11161250	YELLOW	50	9004100000	1000	4	12	121510400		1000
9019300000	50	25	4	11221250	YELLOW	50	9004110000	1000	4	12	121810400		1000
9019310000	50	35	2	11161350	RED	50	9004120000	1000	6	10	121010600		1000
9019330000	50	35	2	11251350	RED	50	9004130000	1000	6	10	121810600		1000
9019340000	50	50	1	11201500	BLUE	50	9004150000	250	16	6	1225116		250
9021010000	500	0.25	24	11610025	YELLOW	500	9004160000	250	16	6	1232116		250
9021020000	500	0.25	24	11810025	YELLOW	500	9004170000	100	25	4	1225125		100
9021030000	500	0.75	20	1163075	BLUE	500	9004180000	100	25	4	1232125		100
9021040000	500	0.75	20	1183075	BLUE	500	9004190000	100	35	2	1225135		100
9021050000	500	0.75	20	11103075	BLUE	500	9004200000	100	35	2	1232135		100
9021060000	500	0.75	20	11123075	BLUE	500	9004210000	100	50	1	1218150		100
9021070000	500	2.5	14	1183025	GREY	500	9004220000	100	50	1	1232150		100
9021080000	500	2.5	14	11123025	GREY	500	9018910000	1000	0.25	26	12510025		1000
							9025880000	100	50	1	1225150		100

WEILAND

AMERICAN ELECTRICAL

WEILAND

AMERICAN ELECTRICAL

PART #	Pcs./BAG	MM	AWG	PART #	COLOR	Pcs./BAG	PART #	Pcs./BAG	MM	AWG	PART #	COLOR	Pcs./BAG
31700	50	25	4	11162250	BROWN	50	902111	500	4	12	11123040	ORANGE	500
31710	50	25	4	11222250	BROWN	50	902112	100	4	12	11183040	ORANGE	100
31720	50	35	2	11162350	BEIGE	50	902113	100	6	10	11123060	GREEN	100
31730	50	35	2	11252350	BEIGE	50	902114	100	6	10	11183060	GREEN	100
40950	500	0.5	20	1162050	ORANGE	500	902115	100	10	8	11123100	BROWN	100
40960	500	0.75	20	1162075	WHITE	500	902116	100	10	8	11183100	BROWN	100
40970	500	1	18	1162010	YELLOW	500	902117	100	16	6	11123160	WHITE	100
44420	50	50	1	11202500	OLIVE	50	902118	100	16	6	11183160	WHITE	100
46290	500	0.75	20	1182075	WHITE	500	902119	50	25	4	11163250	BLACK	50
46300	500	1	16	1182010	YELLOW	500	902120	50	25	4	11253250	BLACK	50
46310	500	1.5	16	1182015	RED	500	902574	500	0.25	24	11620025	BLUE	500
53350	100	6	10	11122060	BLACK	100	902575	500	0.34	24	1162034	TURQ	500
53420	100	10	8	11122100	IVORY	100	902576	500	0.25	24	11820025	BLUE	500
56560	500	1.5	16	11182015	RED	500	902577	500	0.34	24	1182034	TURQ	500
56570	100	6	10	11182060	BLACK	100	902586	500	0.75	20	11102075	WHITE	500
56580	100	10	8	11182100	BEIGE	100	902587	500	0.5	20	1102050	ORANGE	500
56590	100	16	6	11122160	GREEN	100	902591	500	0.75	20	11122075	WHITE	500
56600	100	16	6	11182160	GREEN	100	902593	500	1	18	11122010	YELLOW	500
63510	500	1.5	16	11102015	RED	500	902595	500	1	18	11102010	YELLOW	500
69070	500	0.5	20	1182050	ORANGE	500	902603	500	0.34	24	1161034	TURQ	500
133310	500	2.5	14	1181025	BLUE	500							
901900	500	0.5	20	1161050	WHITE	500	12430	500	16	6	1215116		250
901901	500	0.5	20	1181050	WHITE	500	12440	250	25	4	1215125		100
901902	500	0.5	20	11101050	WHITE	500	12470	500	6	10	121510600		1000
901903	500	0.75	20	1161075	GREY	500	12480	500	10	8	1215110		500
901904	500	0.75	20	1181075	GREY	500	18610	1000	2.5	14	121210250		1000
901905	500	0.75	20	11101075	GREY	500	18650	1000	1.5	16	121010150		1000
901906	500	0.75	20	11121075	GREY	500	19190	500	6	10	121210600		1000
901907	500	1	18	1161010	RED	500	24410	1000	4	12	121210400		1000
901908	500	1	18	1181010	RED	500	28260	1000	0.5	20	12610050		1000
901910	500	1	18	11101010	RED	500	28270	1000	0.75	20	12610075		1000
901911	500	1	18	11121010	RED	500	28280	1000	1	18	121010100		1000
901912	500	1.5	16	1181015	BLACK	500	28290	500	10	8	1212110		500
901913	500	1.5	16	11101015	BLACK	500	36890	100	35	2	1218135		100
901915	500	1.5	16	11181015	BLACK	500	37260	1000	1	18	12610100		1000
901916	500	2.5	14	1181025	BLUE	500	37270	1000	1.5	16	12710150		1000
901916	500	2.5	14	1182025	BLUE	500	37300	1000	2.5	14	12710250		1000
901917	500	2.5	14	11121025	BLUE	500	37310	500	4	12	12910400		1000
901917	500	2.5	14	11122025	BLUE	500	37520	100	16	6	1218116		250
901918	500	2.5	14	11181025	BLUE	500	37530	100	25	4	1218125		100
901918	500	2.5	14	11182025	BLUE	500	37930	500	10	8	1218110		500
901919	500	4	12	11101040	GREY	500	49250	500	16	6	1212116		250
901919	500	4	12	11102040	GREY	500	54250	1000	0.75	20	121010075		1000
901920	500	4	12	11121040	GREY	500	900405	1000	0.5	20	121010050		1000
901920	500	4	12	11122040	GREY	500	900406	1000	1.5	16	121210150		1000
901921	500	4	12	11181040	GREY	100	900407	1000	1.5	16	121810150		1000
901921	500	4	12	11182040	GREY	100	900408	1000	2.5	14	121010250		1000
901922	100	6	10	11121060	YELLOW	100	900409	1000	2.5	14	121810250		1000
901923	100	6	10	11181060	YELLOW	100	900410	1000	4	12	121510400		1000
901924	100	10	8	11121100	RED	100	900411	1000	4	12	121810400		1000
901925	100	10	8	11181100	RED	100	900412	1000	6	10	121010600		1000
901926	100	16	6	11121160	BLUE	100	900413	1000	6	10	121810600		1000
901927	100	16	6	11181160	BLUE	100	900415	250	16	6	1225116		250
901928	50	25	4	11161250	YELLOW	50	900416	250	16	6	1232116		250
901930	50	25	4	11221250	YELLOW	50	900417	100	25	4	1225125		100
901931	50	35	2	11161350	RED	50	900418	100	25	4	1232125		100
901933	50	35	2	11251350	RED	50	900419	100	35	2	1225135		100
901934	50	50	1	11201500	BLUE	50	900420	100	35	2	1232135		100
902101	500	0.25	24	11610025	YELLOW	500	900421	100	50	1	1218150		100
902103	500	0.75	20	1163075	BLUE	500	900422	100	50	1	1232150		100
902104	500	0.75	20	1183075	BLUE	500	901891	1000	0.25	26	12510025		1000
902105	500	0.75	20	11103075	BLUE	500	902588	100	50	1	1225150		100
902106	500	0.75	20	11123075	BLUE	500							
902107	500	2.5	14	1183025	GREY	500							
902108	500	2.5	14	11123025	GREY	500							
902109	500	2.5	14	11183025	GREY	500							
902110	500	4	12	11103040	ORANGE	500							



## **WIRE FERRULE CRIMPING SOLUTIONS: HAND, PNEUMATIC AND AUTOMATIC TOOLS**

AMERICAN ELECTRICAL HAS A WIDE RANGE OF LOW COST, HIGH QUALITY HAND, PNEUMATIC AND AUTOMATIC TOOLS FOR CRIMPING WIRE FERRULES, STRIPPING AND CUTTING WIRE.

WE OFFER BOTH PNEUMATIC AND ELECTRICAL EQUIPMENT TO HELP COMBAT THE FATIGUE AND THE HIGH LABOR ASSOCIATED WITH CRIMPING WIRE FERRULES. OUR PNEUMATIC CRIMPERS COVER FROM 24 AWG TO 8 AWG AND COME IN A LIGHTWEIGHT HANDHELD OR "HANDSFREE" BENCH MODEL. THE CRIMP MAX OPERATES ON 120 VAC AND WILL STRIP AND CRIMP WIRES IN 1.5 SECONDS. IT WEIGHS ONLY 26 POUNDS, PORTABLE ENOUGH TO SUPPORT LOCATIONS AT THE FACTORY FLOOR AND RUGGED ENOUGH TO WITHSTAND IT.

ALL OF OUR TOOLS ARE MADE FROM THE HIGHEST QUALITY MATERIALS FOR LONGEVITY AND ACCURATE CRIMPING.



## WIRE FERRULE HAND CRIMPING TOOLS



### TRAP 24 - 10

TRAPEZOID CRIMPING  
WITH RATCHET, SIDE ENTRY  
RANGE: 24-10 AWG (0.25-6.0 MM<sup>2</sup>)  
FOR SINGLE CONDUCTOR FERRULES  
20-14 AWG (0.5-2.5 MM<sup>2</sup>) FOR  
TWIN FERRULES (TWO WIRES)  
LENGTH: 7.5 INCHES (190 MM)  
WEIGHT: 12.3 OUNCES (350 G)



### TRAP 24 - 10 F

TRAPEZOID CRIMPING  
WITH RATCHET, FRONT ENTRY  
UNIVERSAL DIE  
RANGE: 24-10 AWG (0.25-6.0 MM<sup>2</sup>)  
FOR SINGLE CONDUCTOR FERRULES  
20-14 AWG (0.5-2.5 MM<sup>2</sup>) FOR  
TWIN FERRULES (TWO WIRES)  
LENGTH: 8.7 INCHES (220 MM)  
WEIGHT: 15.1 OUNCES (430 G)



### TRAP 22 - 10

TRAPEZOID CRIMPING  
WITH RATCHET, FRONT ENTRY  
UNIVERSAL DIE  
RANGE: 22-10 AWG (0.5-6.0 MM<sup>2</sup>)  
FOR SINGLE CONDUCTOR FERRULES  
20-14 AWG (0.5-2.5 MM<sup>2</sup>) FOR  
LENGTH: 8.25 INCHES (209 MM)  
WEIGHT: 14.8 OUNCES (460 G)



### TRAP 8 - 4

TRAPEZOID CRIMPING  
WITH RATCHET, SIDE ENTRY  
RANGE: 8-4 AWG (10.0-25.0 MM<sup>2</sup>)  
LENGTH: 8.7 INCHES (220 MM)  
WEIGHT: 18.7 OUNCES (530 G)



### TRAP 2 - 1

TRAPEZOID CRIMPING  
WITH RATCHET, SIDE ENTRY  
RANGE: 2-1 AWG (35.0-50.0 MM<sup>2</sup>)  
LENGTH: 8.7 INCHES (220 MM)  
WEIGHT: 18.7 OUNCES (530 G)



### TRAP 8 - 1

TRAPEZOID CRIMPING  
WITH RATCHET, SIDE ENTRY  
RANGE: 8-1 AWG (10.0-50.0 MM<sup>2</sup>)  
FOR SINGLE CONDUCTOR FERRULES  
12-6 AWG (4.0-16.0 MM<sup>2</sup>) FOR  
TWIN FERRULES (TWO WIRES)  
LENGTH: 13.4 INCHES (340 MM)  
WEIGHT: 28.1 OUNCES (800 G)



## FERRULE CRIMPING TOOLS



### TRAP 24 - 14 L

TRAPEZOID CRIMPING  
 NO RATCHET, SIDE ENTRY  
 RANGE: 24-14 AWG (0.25-2.5 MM<sup>2</sup>)  
 LENGTH: 5.9 INCHES (150 MM)  
 WEIGHT: 5.6 OUNCES (160 G)



### IND 20 - 14 L

INDENT CRIMPING  
 NO RATCHET, UNIVERSAL DIE, SIDE ENTRY  
 RANGE: 20-14 AWG (0.5-2.5 MM<sup>2</sup>)  
 LENGTH: 5.9 INCHES (150 MM)  
 WEIGHT: 7.0 OUNCES (200 G)



### IND 20 - 6 L

INDENT CRIMPING  
 NO RATCHET, SIDE ENTRY  
 RANGE: 20-6 AWG (0.5-16.0 MM<sup>2</sup>)  
 FOR SINGLE CONDUCTOR FERRULES  
 20-10 AWG (0.5-6.0 MM<sup>2</sup>)  
 FOR TWIN FERRULES  
 LENGTH: 9.1 INCHES (230 MM)  
 WEIGHT: 8.8 OUNCES (250 G)



### SQ 28 - 10

SQUARE CRIMPING  
 WITH RATCHET, SIDE ENTRY  
 UNIVERSAL DIE  
 RANGE: 28-8 AWG (0.25-6.0 MM<sup>2</sup>)  
 FOR SINGLE CONDUCTOR FERRULES  
 20-14 AWG (0.5-2.5 MM<sup>2</sup>)  
 FOR TWIN FERRULES  
 LENGTH: 7.1 INCHES (180 MM)  
 WEIGHT: 13.7 OUNCES (390 G)



### TRAP 12 - 8 TW

TRAPEZOID CRIMPING  
 WITH RATCHET, SIDE ENTRY  
 FOR TWIN FERRULES  
 RANGE: 12-8 AWG (4.0-10.0 MM<sup>2</sup>)  
 LENGTH: 8.7 INCHES (220 MM)  
 WEIGHT: 18.7 OUNCES (530 G)



### STCR 20-14

#### STRIP FERRULE STRIPPER & CRIMPER

TRAPEZOID CRIMPER  
 CRIMPS STRIP FERRULES  
 0.5 - 2.5 MM<sup>2</sup>  
 20 - 14 AWG  
 EASILY STRIPS CABLES  
 CABLE CUTTER LOCATED ON TOP

## CABLE STRIPPER



### STRIP 28 - 10

WIRE INSULATION STRIPPER  
WITH WIRE CUTTER

RANGE: 28-10 AWG (0.08-6.0 MM<sup>2</sup>)  
LENGTH: 8.1 INCHES (205 MM)  
WEIGHT: 7.0 OUNCES (200 G)

## CABLE CUTTER



### CUT 6

CABLE CUTTER

RANGE: 6 AWG (16.0 MM<sup>2</sup>) MAXIMUM  
LENGTH: 6.5 INCHES (165 MM)  
WEIGHT: 4.2 OUNCES (120 G)

## CRIMPING TOOL FOR WIRE LUGS



### LUG 20 - 10

CRIMPING TOOL  
FOR INSULATED WIRE LUGS

RANGE: 20-10 AWG (0.5-6.0 MM<sup>2</sup>)  
LENGTH: 8.7 INCHES (220MM)  
WEIGHT: 18.3 OUNCES (520 G)

## FERRULE CRIMPER FOR LARGE WIRES

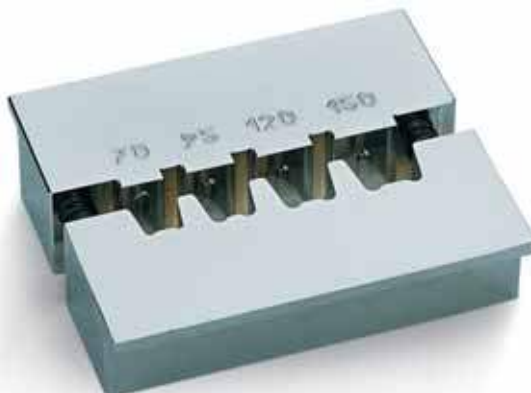

### VICE 70150

TRAPEZOID VICE CRIMPER  
CRIMPS FERRULES

70-150 MM\_  
2/0 AWG - 300 MCM

FITS STANDARD BENCH MOUNTED VICE  
SPRING LOADED FOR EASY RETRACTION  
COMPOSED OF STAINLESS STEEL  
FOUR INDIVIDUAL DIES



## CRIMP-MAX MC 25

AUTOMATIC FERRULE  
STRIPPING & CRIMPING MACHINE  
FOR 20 AWG TO 14 AWG WIRES



### YOUR EFFICIENT HELPER FOR STRIPPING & CRIMPING INSULATED WIRE FERRULES

- THE MC 25 AT 26 POUNDS (12 KG) IS A VERY LIGHT MACHINE. IT CAN BE EASILY TRANSPORTED TO VARIOUS WORK STATIONS.
- IT DOES NOT REQUIRE PRESSURIZED AIR, BUT ONLY A 120 V STANDARD POWER CONNECTION.
- IT TAKES ONLY 1.5 SECONDS TO STRIP AND CRIMP THE INDIVIDUAL WIRES.
- THE MC 25 PROCESSES WIRE FERRULE SIZES 20 AWG TO 14 AWG (0.5 TO 2.5 SQUARE MILLIMETERS) IN THE STANDARD LENGTH OF 8 MM.
- YOU CAN CHANGE THE CRIMP MECHANISM FOR THE SIZE OF THE FERRULES IN A MATTER OF SECONDS WITHOUT ANY ADDITIONAL TOOLS - SIMPLY SNAP IT IN AND IT IS READY TO GO.
- ALL THE CRIMP MECHANISMS NECESSARY ARE CLEARLY LAID OUT IN THE CASE PROVIDED.
- AN ADVANCED MICROPROCESSOR-CONTROLLED CAM DRIVE ENSURES RELIABLE OPERATION.
- THE WIRE FERRULES IN REEL FORM ARE FED VIA A DISPENSER FITTED TO THE RIGHT SIDE OF THE MACHINE FOR EASY HANDS FREE OPERATION.
- THE INSULATED FERRULES USED FOR THIS MACHINE COME IN 1000 PIECE OR 500 PIECE REELS (TAPED MOUNTED) PACKAGED IN A COMPACT CARDBOARD CASE AND ARE FED INTO THE MACHINE AUTOMATICALLY.
- THE MACHINE HAS AN INTEGRAL REEL HOLDER WHICH KEEPS THE FERRULES IN PLACE DURING OPERATION.
- VIDEO OF OPERATION AVAILABLE AT [WWW.AMERICANELECTRICAL.COM/](http://WWW.AMERICANELECTRICAL.COM/).

### MC 25 TECHNICAL DATA

POWER SUPPLY:	120 VAC / 60 HZ
POWER CONSUMPTION:	80 VA
OPERATING RANGE:	20 - 14 AWG (0.5 - 2.5 SQUARE MILLIMETERS)
WIRE FERRULES:	IN ACCORDANCE WITH DIN 46 228 PART 4 TAPE MOUNTED
CRIMP TYPE:	TRAPEZOIDAL
CYCLE:	1.5 SECONDS, APPROXIMATELY
CONTROL:	MICROPROCESSOR-CONTROLLED CAM DRIVE
UNIT COUNTER:	LCD DISPLAY
CHANGING CRIMP MECHANISM:	UNDER 10 SECONDS
DIMENSIONS (W X H X D):	6.5 X 10.6 X 12.6 INCHES (165 X 270 X 320 MM)
WEIGHT:	26 POUNDS (12 KG)





**WIRE FERRULES ON REELS**

FOR USE WITH MC 25

SIZE MM <sup>2</sup>	LENGTH MM	PART NO.	COLOR CODE DIN	PART NO.	COLOR CODE T	PART NO.	COLOR CODE W	PIECES PER BOX
0.50	8	MC1050	WHITE	MC3050	WHITE	MC2050	ORANGE	1000
0.75	8	MC1075	GREY	MC3075	BLUE	MC2075	WHITE	1000
1.00	8	MC1100	RED	MC3100	RED	MC2100	YELLOW	1000
1.50	8	MC1150	BLACK	MC3150	BLACK	MC2150	RED	1000
2.50	8	MC1250	BLUE	MC3250	GREY	MC2250	BLUE	500



### FEATURES

HAND AND BENCH MODELS AVAILABLE  
CRIMPING RANGE 24-8 AWG  
OPERATES WITH PRESSURIZED AIR  
EASY TO USE AND PORTABLE

### PC 24 - 14 B

BENCH-CRIMPER  
TRAPEZOID CRIMPING  
SIDE AND FRONT INSERTION  
UNIVERSAL - DIE  
RANGE 24-14 AWG (0.25-2.50 MM<sup>2</sup>)

LENGTH: 7.9 INCHES (200 MM)  
WEIGHT: 35.2 OUNCES (1000 G)  
PRESSURE: 58 PSI (4 BAR)

### PC 24 - 14 H

HAND-CRIMPER  
TRAPEZOID CRIMPING  
SIDE AND FRONT INSERTION  
UNIVERSAL - DIE  
RANGE 24-14 AWG (0.25-2.50 MM<sup>2</sup>)

LENGTH: 7.9 INCHES (200 MM)  
WEIGHT: 35.2 OUNCES (1000 G)  
PRESSURE: 58 PSI (4 BAR)

### PC 12 - 8 B

BENCH-CRIMPER  
TRAPEZOID CRIMPING  
SIDE ENTRY  
RANGE 12-8 AWG (4-10 MM<sup>2</sup>)

LENGTH: 7.9 INCHES (200 MM)  
WEIGHT: 15.1 OUNCES (430 G)  
PRESSURE: 58 PSI (4 BAR)

### PC 12 - 8 H

HAND-CRIMPER  
TRAPEZOID CRIMPING  
SIDE ENTRY  
RANGE 12-8 AWG (4-10 MM<sup>2</sup>)

LENGTH: 7.9 INCHES (200 MM)  
WEIGHT: 15.1 OUNCES (430 G)  
PRESSURE: 58 PSI (4 BAR)

### ACCESSORY EQUIPMENT:

PC - 1 BALANCER  
PC - 2 MAGNETIC TOOL HOLDER

## LC 100, AUTOMATIC WIRE CUTTER



### FEATURES

CUTS 28 – 8 AWG WIRES  
WEIGHS ONLY 25 LBS.  
1 YEAR WARRANTY  
FULLY PROGRAMMABLE, LENGTH AND NUMBER OF CUTS

### TECHNICAL DATA

DIMENSIONS	7.6 x 11.8 x 8.9"
WEIGHT	24.3 POUNDS
CUTTING CAPACITY	
FINE WIRE	0.08 – 10 MM <sup>2</sup> , 28 – 8 AWG
SINGLE WIRE	0.08 – 2.5 MM <sup>2</sup> , 28 – 8 AWG
MAX DIAMETER	8 MM
FEED SPEED	MAX 0.5 M/S, 20"/SECOND
UNIT OF MEASURE	MM AND INCHES
INTERFACE	RS232
CROSS SECTION SETTING	AUTOMATIC





## DIN RAIL

WE OFFER A COMPLETE LINE OF SLOTTED OR SOLID DIN RAIL – 35MM X 15MM, 35MM X 7.5MM) IN 1 OR 2 METER LENGTHS. DIN RAIL MOUNTS IN A VARIETY OF ENCLOSURES AND JUNCTION BOXES.

DIN RAIL SAVES SPACE SINCE IT ORGANIZES TERMINALS IN A SET PATTERN. DIN RAIL SAVES TIME SINCE MANY OTHER CONTROL COMPONENTS CAN BE MOUNTED ON THE SAME RAIL – NO COMPONENTS ARE DIRECT MOUNTED – ULTIMATELY SAVING OUR CUSTOMERS MONEY.

OUR DIN RAIL IS MADE OF STEEL AND ZINC PLATED FINISH, WHICH IS THE INDUSTRY STANDARD AND ALSO ROHS COMPLIANT. AS ALWAYS, OUR RAILS ARE NOT MARKED WITH A COMPANY NAME AND ARE CE APPROVED.



# DIN RAIL STEEL

## FEATURES

STEEL DESIGN  
ZINC PLATING  
2 METER LENGTH  
COMPETITIVE PRICING

INDUSTRY STANDARD MATERIALS  
CE APPROVED  
NO MARKINGS ON RAIL



### SLOTTED

35 MM X 7.5 MM  
SLOTTED  
STANDARD PACK: 40

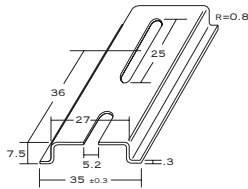

**TS3575SL**  
**TS3575SL1**

### SOLID

35 MM X 7.5 MM  
SOLID  
STANDARD PACK: 40

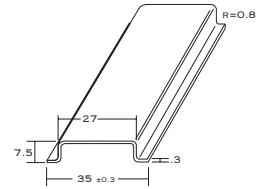

**TS3575SOL**

35 MM X 15 MM  
SLOTTED  
STANDARD PACK: 20

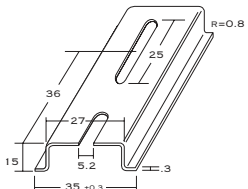

**TS3515SL**

35 MM X 15 MM  
SOLID  
STANDARD PACK: 20

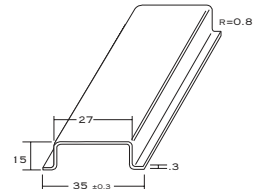

**TS3515SOL**

35 MM X 15 MM  
SOLID  
STANDARD PACK: 20

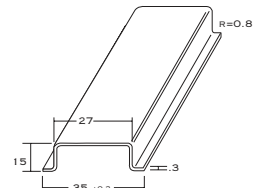

**TS3515SOLH**

## DIN RAIL CROSS REFERENCE

	<b>TS3575SL</b>	<b>TS3575SOL</b>	<b>TS3515SL</b>	<b>TS3515SOL</b>	<b>TS3515SOLH</b>
AMERICAN ELECTRICAL					
ENTRELEC	173220.05	174300.17	101598.26	168700.22	168500.12
PHOENIX CONTACT	801733	801681	1201730	1201717	-
WAGO	210-112	210-113	210-197	210-114	210-118
WEIDMULLER	51450	38340	23650	23640	49800
WIELAND	98.300.10000.0	98.300.10000.0	98.300.10000.0	98.300.10000.0	98.300.10000.0



## DIN RAIL ALUMINUM

### FEATURES

LIGHTWEIGHT ALUMINUM  
1 METER LENGTH  
COMPETITIVE PRICING

STANDARD PACK OF 40  
NO MARKINGS ON RAIL

35 MM X 7.5 MM  
SLOTTED  
STANDARD PACK: 40

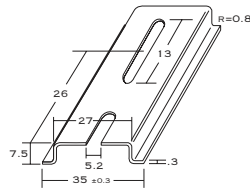
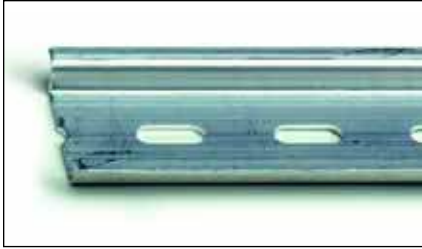

**TS3575SL1-A**

## DIN RAIL CUTTER

### TS 3 CUT

#### FEATURES

CUTS 35X15, 35X7.5 AND 15MM DIN RAIL  
NO DEBURRING NECESSARY. CLEAN CUTS  
LITTLE FORCE REQUIRED FOR OPERATION  
FAST, ACCURATE CUTS  
INTEGRATED 1 METER MEASURING STICK INCLUDED



#### TECHNICAL DATA

LENGTH STOP: MAX. 1000 MM  
DIMENSIONS: 1090 (L) X 150 (W) X 760 (D) MM  
43 (L) X 6 (W) X 30 (D) INCHES  
WEIGHT: 18 LBS, 8.3 KG



## **DIN RAIL MOUNTED POWER SUPPLIES**

AMERICAN ELECTRICAL HAS TWO LINES OF DIN RAIL POWER SUPPLIES TO CHOOSE FROM. ALL ARE 120VAC IN AND 24VDC OUT (OTHER VOLTAGE OUTPUTS MAY BE ORDERED, PLEASE CALL US). WE ALSO HAVE 3-PHASE POWER SUPPLIES UP TO 480VAC IN AND 24VDC OUT.

ALL POWER SUPPLIES ARE UL LISTED AND EMI/RFI APPROVED.





## 45 WATTS, 1.875 AMPS, 24VDC

### FEATURES

- UL508 LISTED
- INSTALLS EASILY ON DIN RAIL TS35 X 7.5 AND 15MM
- FIXED SWITCHING FREQUENCY AT 100KHZ
- LED POWER ON INDICATOR
- FREE AIR CONVECTION COOLING
- 100% FULL LOAD BURN-IN TEST
- 1 YEAR WARRANTY

### TECHNICAL DATA

PART NUMBER	<b>DR-45-24</b>
AC INPUT VOLTAGE RANGE	85 – 265VAC; 120-370VDC
DC ADJUSTMENT RANGE	±10% RATED OUTPUT VOLTAGE
OVER LOAD PROTECTION	105% - 150% CONSTANT CURRENT LIMITING, AUTO RECOVERY
OVER VOLTAGE PROTECTION	115% - 135% RATED OUTPUT VOLTAGE
SETUP, RISE, HOLD UP TIME	800MS, 60MS, 50MS AT FULL LOAD AND 230VAC
WITHSTAND VOLTAGE	I/P-O/P:3KVAC, I/P-FG:1.5KVAC, 1 MINUTE
WORKING TEMPERATURE	0 - 45_C@100%, -10_C@80%, 50_C@80% LOAD
SAFETY STANDARDS	UL508, TUV EN60950 1 APPROVED
EMC STANDARDS	EN55022 CLASS B, EN61000-3-2,3 EN61000-6-2, EN61000-4-2,3,4,5,6,8,11,
ENV50204	
CONNECTION	I/P: 3 POLES, O/P: 4 POLES SCREW DIN TERMINAL
DIMENSIONS	78 X 93 X 67MM



## 75 WATTS, 3.125 AMPS, 24VDC

### FEATURES

- UL508 LISTED
- INSTALLS EASILY ON DIN RAIL TS35 X 7.5 AND 15MM
- FIXED SWITCHING FREQUENCY AT 50KHZ
- LED POWER ON INDICATOR
- FREE AIR CONVECTION COOLING
- 100% FULL LOAD BURN-IN TEST
- 1 YEAR WARRANTY

### TECHNICAL DATA

PART NUMBER	<b>DR-75-24</b>
AC INPUT VOLTAGE RANGE	85 – 265VAC; 120-370VDC
DC ADJUSTMENT RANGE	12V: 12-14V, 24V: 24-28V, 48V: 48-53V
OVER LOAD PROTECTION	105% - 150% CONSTANT CURRENT LIMITING, AUTO RECOVERY
OVER VOLTAGE PROTECTION	121% - 142% RATED OUTPUT VOLTAGE
SETUP, RISE, HOLD UP TIME	1000MS, 60MS, 50MS AT FULL LOAD AND 230VAC
WITHSTAND VOLTAGE	I/P-O/P:3KVAC, I/P-FG:1.5KVAC, 1 MINUTE
WORKING TEMPERATURE	-10_C – 60_C
SAFETY STANDARDS	UL508, TUV EN60950 1 APPROVED
EMC STANDARDS	EN55022 CLASS B, EN61000-3-2,3 EN61000-6-2, EN61000-4-2,3,4,5,6,8,11,
ENV50204	
CONNECTION	I/P: 3 POLES, O/P: 4 POLES SCREW DIN TERMINAL
DIMENSIONS	55.5 X 125.2 X 100MM





## 120 WATTS, 5 AMPS, 24VDC



### FEATURES

AC INPUT SELECTED BY SWITCH  
 INSTALLS EASILY ON DIN RAIL TS35 X 7.5 AND 15MM  
 FIXED SWITCHING FREQUENCY AT 55KHZ  
 LED POWER ON INDICATOR  
 FREE AIR CONVECTION COOLING  
 100% FULL LOAD BURN-IN TEST  
 1 YEAR WARRANTY

### TECHNICAL DATA

PART NUMBER	<b>DR-120-24</b>
AC INPUT VOLTAGE RANGE	88 – 132VAC; 176 - 264VAC SELECTED BY SWITCH
DC ADJUSTMENT RANGE	12V: 12-14V, 24V: 24-28V, 48V: 48-53V
OVER LOAD PROTECTION	105% - 150% CONSTANT CURRENT LIMITING, AUTO RECOVERY
OVER VOLTAGE PROTECTION	120% - 140% RATED OUTPUT VOLTAGE
SETUP, RISE, HOLD UP TIME	500MS, 70MS, 30MS AT FULL LOAD AND 230VAC
WITHSTAND VOLTAGE	I/P-O/P:3KVAC, I/P-FG:1.5KVAC, 1 MINUTE
WORKING TEMPERATURE	-10_C – 60_C
SAFETY STANDARDS	UL508, UL60950-1, TUV EN60950 1 APPROVED
EMC STANDARDS	EN55022 CLASS B, EN61000-3-2,3 EN61000-6-2, EN61000-4-2,3,4,5,6,8,11, ENV50204
CONNECTION	I/P: 3 POLES, O/P: 4 POLES SCREW DIN TERMINAL
DIMENSIONS	65.5 X 125.2 X 100MM

## 240 WATTS, 10 AMPS, 24VDC

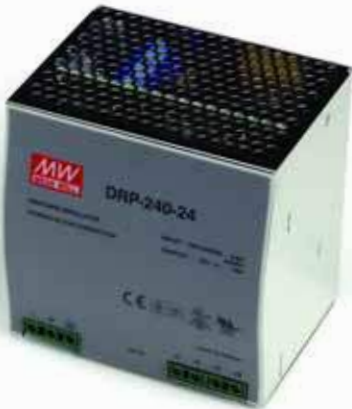

### FEATURES

- UNIVERSAL AC INPUT/FULL RANGE
- PF>0.98@115VAC, >0.95@230VAC
- INSTALLS EASILY ON DIN RAIL TS35 X 7.5 AND 15MM
- FIXED SWITCHING FREQUENCY AT 100KHZ
- LED POWER ON INDICATOR
- FREE AIR CONVECTION COOLING
- 100% FULL LOAD BURN-IN TEST
- 1 YEAR WARRANTY

### TECHNICAL DATA

PART NUMBER	<b>DRP-240-24</b>
AC INPUT VOLTAGE RANGE	85 – 264VAC; 120 – 370VDC
DC ADJUSTMENT RANGE	24V: 24-28V
OVER LOAD PROTECTION	105% - 150% CONSTANT CURRENT LIMITING, AUTO RECOVERY
OVER VOLTAGE PROTECTION	30 – 36V
SETUP, RISE, HOLD UP TIME	800MS, 40MS, 20MS AT FULL LOAD AND 230VAC
WITHSTAND VOLTAGE	I/P-O/P:3KVAC, I/P-FG:1.5KVAC, 1 MINUTE
WORKING TEMPERATURE	-10_C – 55_C@100%, 70_C@60% LOAD
SAFETY STANDARDS	UL508, UL60950-1, TUV EN60950 1 APPROVED
EMC STANDARDS	EN55022 CLASS B, EN61000-3-2,3 EN61000-6-2, EN61000-4-2,3,4,5,6,8,11, ENV50204
CONNECTION	I/P: 3 POLES, O/P: 4 POLES SCREW DIN TERMINAL
DIMENSIONS	125.5 X 125.2 X 100MM



## 240 WATTS THREE PHASE, 10 AMPS, 24VDC

### FEATURES

- INPUT 340-550VAC, 3 PHASE 4 WIRES
- HIGH EFFICIENCY AND LOW DISSIPATION
- INSTALLS EASILY ON DIN RAIL TS35 X 7.5 AND 15MM
- EN61000-6-2 INDUSTRIAL IMMUNITY LEVEL
- FREE AIR CONVECTION COOLING
- 100% FULL LOAD BURN-IN TEST
- 1 YEAR WARRANTY

### TECHNICAL DATA

PART NUMBER	<b>DRT-240-24</b>
AC INPUT VOLTAGE RANGE	340 – 550VAC; 3 PHASE 4 WIRES (DUAL OPERATION POSSIBLE)
DC ADJUSTMENT RANGE	24V: 24-28V
OVER LOAD PROTECTION	105% - 150% CONSTANT CURRENT LIMITING, AUTO RECOVERY
OVER VOLTAGE PROTECTION	30 – 36V
OVER TEMP. PROTECTION	SHUT DOWN OUTPUT VOLTAGE, RECOVERS AUTO
WITHSTAND VOLTAGE	I/P-O/P:3KVAC, I/P-FG:1.5KVAC, 1 MINUTE
WORKING TEMPERATURE	-20_C – 70_C
SAFETY STANDARDS	UL508, UL60950-1, TUV EN60950 1 APPROVED
EMC STANDARDS	EN55022 CLASS B, EN61000-3-2,3, EN61204-3 EN61000-6-2, EN61000-4-2,3,4,5,6,8,11, ENV50204
CONNECTION	I/P: 3 POLES, O/P: 4 POLES SCREW DIN TERMINAL
DIMENSIONS	125.5 X 125.2 X 100MM



## 480 WATTS THREE PHASE, 20 AMPS, 24VDC

### FEATURES

- INPUT 340-550VAC, 3 PHASE 4 WIRES
- HIGH EFFICIENCY UP TO 90%
- INSTALLS EASILY ON DIN RAIL TS35 X 7.5 AND 15MM
- EN61000-6-2 INDUSTRIAL IMMUNITY LEVEL
- FREE AIR CONVECTION COOLING
- 100% FULL LOAD BURN-IN TEST
- 1 YEAR WARRANTY

### TECHNICAL DATA

PART NUMBER	<b>DRT-480-24</b>
AC INPUT VOLTAGE RANGE	340 – 550VAC; 3 PHASE 4 WIRES (DUAL OPERATION POSSIBLE)
DC ADJUSTMENT RANGE	24V: 24-28V
OVER LOAD PROTECTION	105% - 150% CONSTANT CURRENT LIMITING, AUTO RECOVERY
OVER VOLTAGE PROTECTION	30 – 36V, AC RECYCLE TO RESTART
OVER TEMP. PROTECTION	SHUT DOWN OUTPUT VOLTAGE, RECOVERS AUTO
WITHSTAND VOLTAGE	I/P-O/P:3KVAC, I/P-FG:1.5KVAC, O/P-FG: 0.5KVAC, 1 MINUTE
WORKING TEMPERATURE	-20_C – 70_C
SAFETY STANDARDS	UL508, UL60950-1, TUV EN60950 1 APPROVED
EMC STANDARDS	EN55022 CLASS B, EN61000-3-2,3, EN61204-3 EN61000-6-2, EN61000-4-2,3,4,5,6,8,11, ENV50204
CONNECTION	I/P: 3 POLES, O/P: 4 POLES SCREW DIN TERMINAL
DIMENSIONS	227 X 125.2 X 100MM



## DIN RAIL MOUNTED POWER SUPPLIES

### FEATURES

WIDE RANGE	COMPACT HOUSING 20A, 3PH ONLY 3.39 INCHES LONG
OUTPUT	HORIZONTAL MOUNTING UP TO 40A, 3 PHASE 24V / 1.25 TO 20A - SINGLE PHASE 24V / 10, 20, AND 40A - 3 PHASE
UNIVERSAL INPUT	115 / 230 VAC 3 X 340 / 550 VAC
LOAD SHARING	PARALLEL OPERATION REDUNDANCY
HIGH EFFICIENCY	TYPICAL 90%
INCREASED OPERATING TEMPERATURE	100% AT 140°F
STATUS INDICATION	POWER ON INDICATION OVERLOAD STATUS LED
TOUCH SAFE POWER ENTRY	COVERED POWER ENTRY CONVENIENT CUSTOMER INPUT TERMINALS
APPROVALS	UL / CSA AND EN 60950 EMC CERTIFIED



### 30 WATTS, 1.25 AMPS, 24VDC

#### TECHNICAL DATA SLIMLINE

PART NUMBER	<b>F2400125</b>
AC INPUT VOLTAGE	115*/230
PHASE	1
DC OUTPUT VOLTAGE	24
OUTPUT CURRENT (AMPS)	1.25
POWER (WATTS)	30
DIMENSIONS (INCHES)	1.77 X 12.83 X 4.13



### 120 WATTS, 5 AMPS, 24VDC

#### TECHNICAL DATA SLIMLINE

PART NUMBER	<b>F240050S</b>
AC INPUT VOLTAGE	115*/230
PHASE	1
DC OUTPUT VOLTAGE	24
OUTPUT CURRENT (AMPS)	5
POWER (WATTS)	120
DIMENSIONS (INCHES)	2.76 X 5.2 X 5.47



### 240 WATTS, 10 AMPS, 24VDC

#### TECHNICAL DATA SLIMLINE

PART NUMBER	<b>F24010S</b>
AC INPUT VOLTAGE	115*/230
PHASE	1
DC OUTPUT VOLTAGE	24
OUTPUT CURRENT (AMPS)	10
POWER (WATTS)	240
DIMENSIONS (INCHES)	2.76 X 5.81 X 6.46



\* INDICATES STANDARD VOLTAGE INPUTS



### 240 WATTS, 10 AMPS, 24VDC



#### TECHNICAL DATA SLIMLINE 3 PHASE

PART NUMBER	<b>F24010S-3</b>
AC INPUT VOLTAGE	3x 340-550
PHASE	3
DC OUTPUT VOLTAGE	24
OUTPUT CURRENT (AMPS)	10
POWER (WATTS)	240
DIMENSIONS (INCHES)	3.18 X 6.02 X 6.29

### 480 WATTS, 20 AMPS, 24VDC



#### TECHNICAL DATA SLIMLINE 3 PHASE

PART NUMBER	<b>F24020S-3</b>
AC INPUT VOLTAGE	3x 340-550
PHASE	3
DC OUTPUT VOLTAGE	24
OUTPUT CURRENT (AMPS)	20
POWER (WATTS)	480
DIMENSIONS (INCHES)	3.99 X 8.94 X 6.81

### 60 WATTS, 2.5 AMPS, 24VDC



#### TECHNICAL DATA HORIZONTAL

PART NUMBER	<b>F240025</b>
AC INPUT VOLTAGE	115*/230
PHASE	1
DC OUTPUT VOLTAGE	24
OUTPUT CURRENT (AMPS)	2.5
POWER (WATTS)	60
DIMENSIONS (INCHES)	4.25 X 4.84 X 2.56

### 120 WATTS, 5 AMPS, 24VDC



#### TECHNICAL DATA HORIZONTAL

PART NUMBER	<b>F240050</b>
AC INPUT VOLTAGE	115*/230
PHASE	1
DC OUTPUT VOLTAGE	24
OUTPUT CURRENT (AMPS)	5
POWER (WATTS)	120
DIMENSIONS (INCHES)	5.79 X 4.84 X 3.39

\* INDICATES STANDARD VOLTAGE INPUTS



240 WATTS, 10 AMPS, 24VDC

### TECHNICAL DATA HORIZONTAL

PART NUMBER	<b>F24010</b>
AC INPUT VOLTAGE	115*/230
PHASE	1
DC OUTPUT VOLTAGE	24
OUTPUT CURRENT (AMPS)	10
POWER (WATTS)	240
DIMENSIONS (INCHES)	8.07 X 4.84 X 3.39



480 WATTS, 20 AMPS, 24VDC

### TECHNICAL DATA HORIZONTAL

PART NUMBER	<b>F24020</b>
AC INPUT VOLTAGE	195-265
PHASE	1
DC OUTPUT VOLTAGE	24
OUTPUT CURRENT (AMPS)	20
POWER (WATTS)	480
DIMENSIONS (INCHES)	9.45 X 6.02 X 3.39



480 WATTS, 20 AMPS, 24VDC

### TECHNICAL DATA HORIZONTAL 3 PHASE

PART NUMBER	<b>F24020-3</b>
AC INPUT VOLTAGE	3x 340-550
PHASE	3
DC OUTPUT VOLTAGE	24
OUTPUT CURRENT (AMPS)	20
POWER (WATTS)	480
DIMENSIONS (INCHES)	9.45 X 6.02 X 3.39



960 WATTS, 40 AMPS, 24VDC

### TECHNICAL DATA HORIZONTAL 3 PHASE

PART NUMBER	<b>F24040-3</b>
AC INPUT VOLTAGE	3x 340-550
PHASE	3
DC OUTPUT VOLTAGE	24
OUTPUT CURRENT (AMPS)	40
POWER (WATTS)	960
DIMENSIONS (INCHES)	11.5 X 7.28 X 5.12

\* INDICATES STANDARD VOLTAGE INPUTS



## DIN RAIL MOUNTED GFCI



### DIN 120 GFCI

#### FEATURES

DUAL 120V AC RECEPTACLE, DIN RAIL MOUNTED  
3 FOOT, HOT/NEUTRAL/GROUND CABLE  
GREEN LED FOR POWER ON INDICATION  
CURRENT RATING, 20 A  
GROUND FAULT CIRCUIT PROTECTION WITH RESET  
DIN RAIL & DIRECT MOUNTABLE  
STANDARD RECEPTACLE SIZE  
ALL COMPONENTS UL APPROVED

## DIN RAIL MOUNTED CIRCUIT BREAKERS

AEI CARRIES A 13MM WIDE CIRCUIT BREAKER, THE THINNEST DIN RAIL MOUNTED ON THE MARKET. WE HAVE THREE TYPES OF BREAKERS. FOR AC CIRCUITRY WE HAVE UL 1077 AND UL 489 (UL LISTED) RATED BREAKERS. FOR DC CIRCUITS WE HAVE A UL 489 A RATED BREAKER.

POLE COUNT AND MAX. AMPERAGE IS GIVEN BELOW:

CIRCUIT	TYPE	MAX. POLES	MAX. AMPS
AC	UL 1077	3	50
AC	UL 489	2	25
DC	UL 489 A	1	50

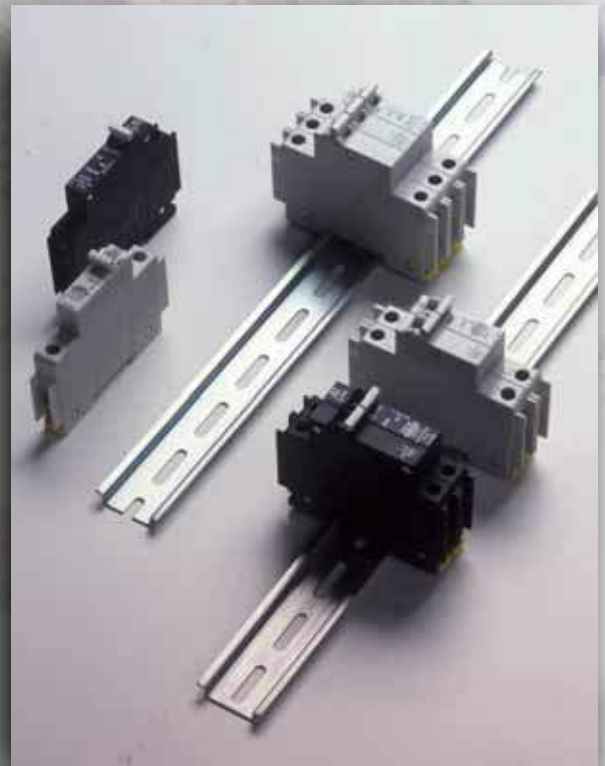



# DIN RAIL MOUNTED CIRCUIT BREAKERS

## UL 1077 RATED

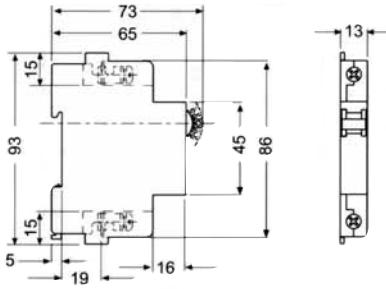

### FEATURES

- UL 1077 APPROVED
- DIN RAIL MOUNTED
- COMPACT 13 MM WIDTH
- ONE, TWO & THREE POLE
- CURRENT RATING UP TO 50 A
- 100% RATING CAPABILITY
- HYDRAULIC-MAGNETIC TECHNOLOGY
- TRIP CURVE 2 STANDARD

### TECHNICAL DATA

NUMBERS OF POLES	1, 2 & 3
MAXIMUM VOLTAGE	277/480 50/60 Hz
MINIMUM AMP RATING	1 AMP
MAXIMUM AMP RATING	50 AMP
INTERRUPTING CAP.	5000A @ 120V 1000A @ 277V 1000A @ 480V
DIELECTRIC STRENGTH	1960V 50/60 Hz
INSULATION RESISTANCE	100 MEGA OHM
OPERATING TEMP. RANGE	-40°C TO +60°C

### PART NUMBERING SYSTEM

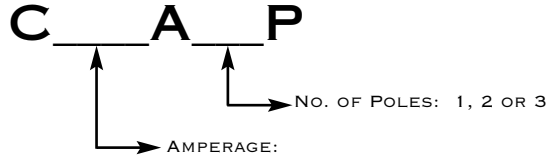

E.G., 1 FOR 1 AMP, 15 FOR 15 AMP, ETC.

EXAMPLE: C10A1P = 10A SINGLE POLE CIRCUIT BREAKER



## UL 489 RATED

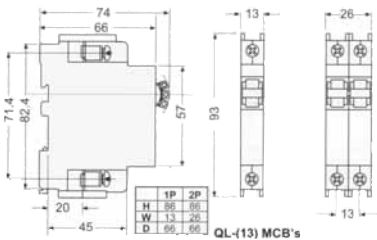

### FEATURES

- UL 489 APPROVED
- DIN RAIL MOUNTED
- COMPACT 13 MM WIDTH
- ONE & TWO POLE ONLY
- CURRENT RATING UP TO 25 A
- 100% RATING CAPABILITY
- HYDRAULIC-MAGNETIC TECHNOLOGY
- TRIP CURVE KM STANDARD

### TECHNICAL DATA

NUMBERS OF POLES	1 AND 2 POLE ONLY
MAXIMUM VOLTAGE	120/240V 50/60 Hz
MINIMUM AMP RATING	1 AMP
MAXIMUM AMP RATING	25 AMP
INTERRUPTING CAP.	10,000 A
DIELECTRIC STRENGTH	1500V 50/60 Hz
INSULATION RESISTANCE	100 MEGA OHM
OPERATING TEMP. RANGE	-40°C TO +60°C

### PART NUMBERING SYSTEM

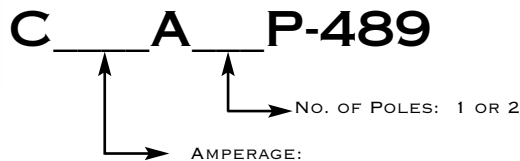

E.G., 1 FOR 1 AMP, 15 FOR 15 AMP, ETC.

EXAMPLE: C10A1P = 10A SINGLE POLE CIRCUIT BREAKER





# DIN RAIL MOUNTED CIRCUIT BREAKERS

## UL 489A RATED

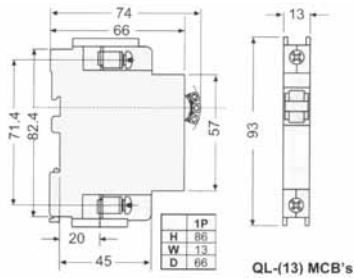

### FEATURES

- UL 489A
- DIN RAIL MOUNTED
- COMPACT 13 MM WIDTH
- ONE POLE ONLY
- CURRENT RATING UP TO 50 A
- 100% RATING CAPABILITY
- HYDRAULIC-MAGNETIC TECHNOLOGY
- TRIP CURVE U2 STANDARD

### TECHNICAL DATA

NUMBERS OF POLES	1 ONLY
MAXIMUM VOLTAGE	80 VDC
MINIMUM AMP RATING	1 AMP
MAXIMUM AMP RATING	50 AMP
INTERRUPTING CAP.	10,000A
DIELECTRIC STRENGTH	1500V 50/60 Hz
INSULATION RESISTANCE	100 MEGA OHM
OPERATING TEMP. RANGE	-40°C TO +60°C

### PART NUMBERING SYSTEM

**C**      **A1P-80VDC**



E.G., 1 FOR 1 AMP, 15 FOR 15 AMP, ETC.

EXAMPLE: C10A1P-80VDC = 10A UL489A RATED CB

### TRIP CURVE

UL 1077 RATED  
CURVE 2

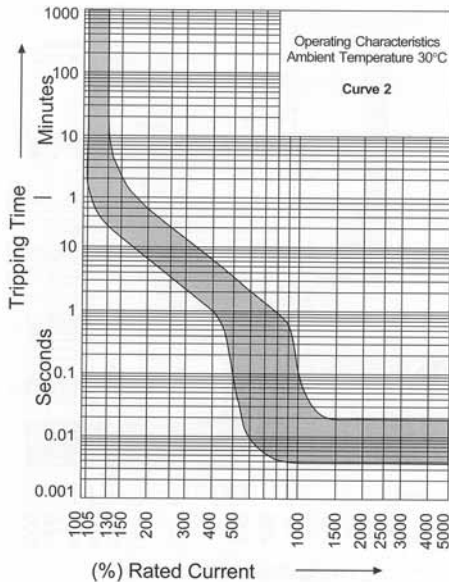

UL 489 RATED  
CURVE KM

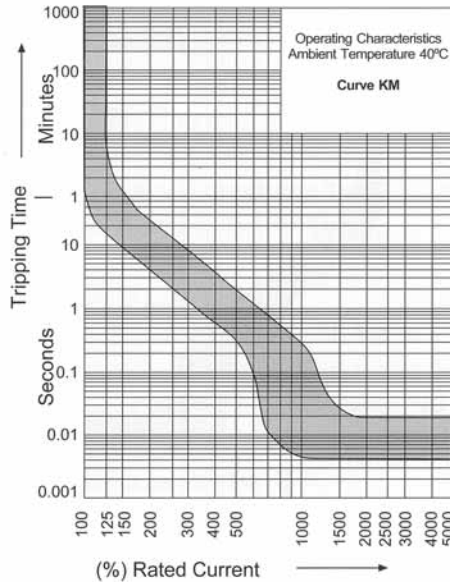

UL 489A RATED  
CURVE U2

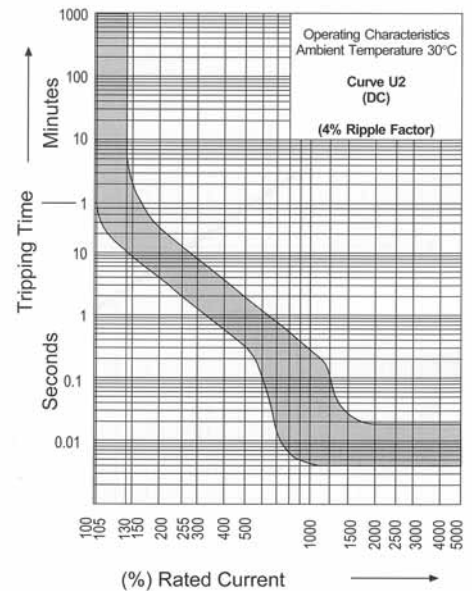

TRIP CURVE 3 AND TRIP CURVE 9 AVAILABLE AT [WWW.AMERICANELECTRIC.COM](http://WWW.AMERICANELECTRIC.COM).



## DIN RAIL MOUNTED FUSE HOLDERS

APPLICATIONS REQUIRING CIRCUIT PROTECTION ARE OFTEN SPECIFIED WITH FUSES INSTEAD OF CIRCUIT BREAKERS. AEI OFFERS FUSE HOLDERS CAPABLE OF PROTECTING CIRCUITS UTILIZING THE FOUR MAIN STYLES OF FUSES:

- 5X20MM AND 5X25MM (SEE PAGES 27, 29, 32)
- 1 1/4"X1/4" (SEE PAGES 29, 30)
- 1 1/2"X1 3/32" (SEE NEXT PAGE)
- 2"X1/2"(14X51MM) (SEE NEXT PAGE)

ALL OF THE ABOVE ARE AVAILABLE IN STANDARD FUSE BLOCKS OR WITH "FUSE BLOWN" INDICATION (24VDC AND 110VAC CIRCUITS).

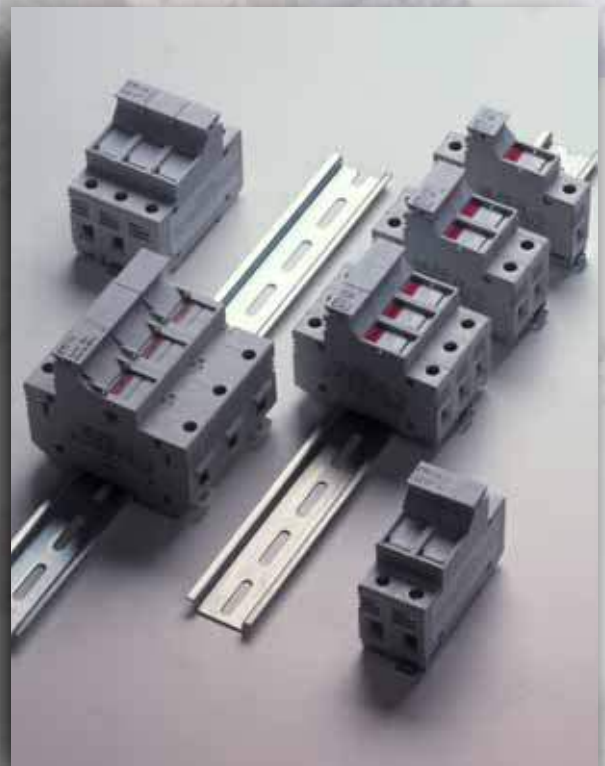

## DIN RAIL MOUNTED FUSE HOLDERS

FOR 1.5" X 13/32" FUSES

### ASK 4

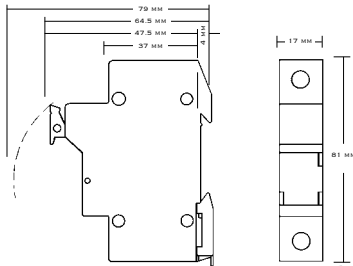

#### FEATURES

DIN RAIL MOUNTABLE  
BOTH INDICATING AND NON INDICATING AVAILABLE  
COMPACT AT 17MM WIDTH

#### TECHNICAL DATA

NUMBERS OF POLES	1, 2 & 3
VOLTAGE	600
AMPS	32 AMP
WIRE SIZE AWG	26...6

#### PART NUMBERING SYSTEM

NO. OF POLES	INDICATOR TYPE	PART NUMBER
1	NON-INDICATING	<b>2541000</b>
2	NON-INDICATING	<b>2543000</b>
3	NON-INDICATING	<b>2544000</b>
1	WITH INDICATOR	<b>2541100</b>
2	WITH INDICATOR	<b>2543100</b>
3	WITH INDICATOR	<b>2544100</b>



## DIN RAIL MOUNTED FUSE HOLDERS

FOR 14 X 51 MM FUSES

### ASK 6

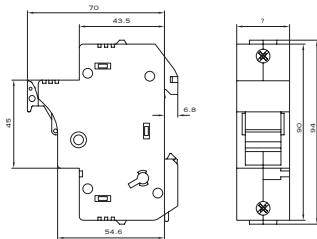

ASK 6

#### FEATURES

DIN RAIL MOUNTABLE  
BOTH INDICATING AND NON INDICATING AVAILABLE

#### TECHNICAL DATA

NUMBERS OF POLES	1, 2 & 3
VOLTAGE	600
AMPS	50 AMP
WIRE SIZE AWG	26...6

#### PART NUMBERING SYSTEM

NO. OF POLES	INDICATOR TYPE	PART NUMBER
1	NON-INDICATING	<b>2561000</b>
2	NON-INDICATING	<b>2563000</b>
3	NON-INDICATING	<b>2564000</b>
1	WITH INDICATOR	<b>2561100</b>
2	WITH INDICATOR	<b>2563100</b>
3	WITH INDICATOR	<b>2564100</b>





## **DIN RAIL MOUNTED INTERFACE MODULES**

THE AEI INTERFACE MODULES ARE AVAILABLE WITH D-SUBMINIATURE OR IDC CONNECTORS. THESE INTERFACE MODULES ALLOW THE USERS TO ATTACH FIELD WIRING AND “PLUG AND PLAY” THE INTERFACE MODULE TO THE CONTROLLER. OUR D-SUB MODULES COME WITH BOTH MALE AND FEMALE CONNECTORS AND IDC COME WITH MALE ONLY. WE ALSO OFFER TWO METER CABLES TO COMPLEMENT THE DESIGN.

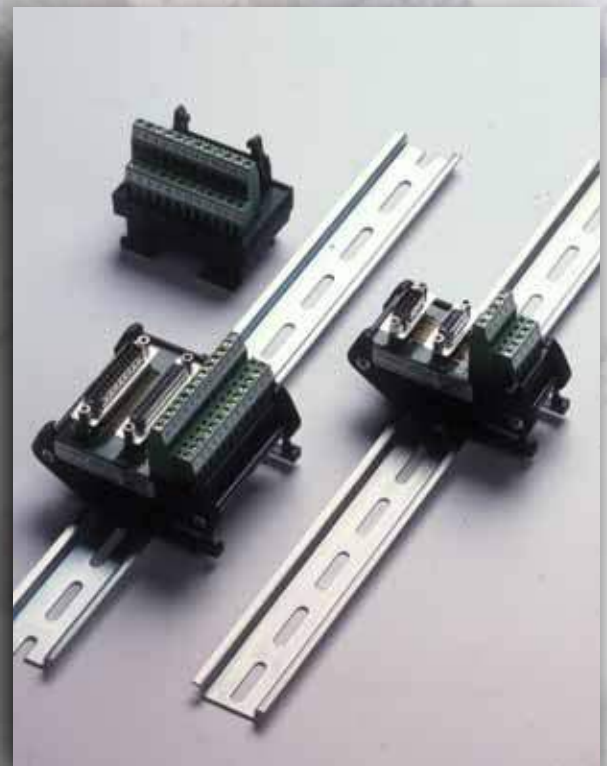

# DIN RAIL MOUNTED INTERFACE MODULES

## D-SUB

### FEATURES

MAXIMUM CURRENT: 1 A  
 WIRE RANGE: 22 - 14 AWG  
 OPERATING TEMPERATURE: -10°C TO 50°C

MODULES ARE DESIGNED WITH MALE AND FEMALE CONNECTORS, 9, 15 OR 25 PIN OPTIONS.



### TECHNICAL DATA - D-SUB

PART NUMBER	DSUB-9-MF	DSUB-15-MF	DSUB-25-MF
NUMBER OF CHANNELS	9	15	25
DIMENSIONS	1.53 x 2.48 x 2.5" (39 x 63 x 93MM)	1.93 x 2.48 x 2.58" (49 x 63 x 93MM)	2.87 x 2.48 x 2.58" (73 x 63 x 93MM)

### CABLES - D-SUB (CONNECTORS ON BOTH ENDS)

PART NUMBER	DSUB-9-MF-CBL	DSUB-15-MF-CBL	DSUB-25-MF-CBL
CABLE LENGTH	2 METERS	2 METERS	2 METERS
INSULATION RATING	300V 80°C	300V 80°C	300V 80°C
CONDUCTOR SIZE	#28 AWG	#28 AWG	#28 AWG

## IDC

### FEATURES

MAXIMUM VOLTAGE: 600V  
 MAXIMUM CURRENT: 2 A  
 WIRE RANGE: 22 - 14 AWG

CONTACTS: COPPER ALLOY, TIN LEAD PLATING  
 TIGHTENING TORQUE: 3.5 LB-IN (0.4NM)  
 OPERATING TEMPERATURE: -10°C TO 50°C



### TECHNICAL DATA - IDC

PART NUMBER	IDC-20-M	IDC-24-M	IDC-40-M
NUMBER OF PINS	20	20	20
DIMENSIONS	1.53 x 2.48 x 2.5" (39 x 63 x 93MM)	1.93 x 2.48 x 2.58" (49 x 63 x 93MM)	2.87 x 2.48 x 2.58" (73 x 63 x 93MM)

### CABLES - IDC (CONNECTORS ON ONE END)

PART NUMBER	IDC-20-M-CBL	IDC-24-M-CBL	
CABLE LENGTH	2 METERS	2 METERS	
INSULATION RATING	300V 80°C	300V 80°C	
CONDUCTOR SIZE	#24 AWG	#24 AWG	



## **DIN RAIL MOUNTED DISCONNECT SWITCHES**

AEI HAS TWO SERIES OF DISCONNECT SWITCHES, RANGING FROM 16 A TO 125 A. ISOLATION OF CONTROL EQUIPMENT IS AN IMPORTANT DESIGN CONSIDERATION. OUR DISCONNECT SWITCHES CAN PROVIDE ISOLATION AND LOCK OUT POINTS FOR POWER SUPPLIES, TRANSFORMERS, SMALL MOTORS OR ANY OTHER TYPES OF CONTROLS.

ACCESSORIES, SUCH AS AUXILIARY CONTACTS ARE USED TO ELECTRICALLY INDICATE THE SWITCH POSITION. REMOTE OPERATION SHUTS OFF AND HANDLES ARE OFFERED FOR THOSE DESIGNS THAT ARE THRU-PANEL.



# DIN RAIL MOUNTED DISCONNECT SWITCHES

## SD1 SERIES

### FEATURES

16-40 AMPS

ALLOWS BREAKING AND DISCONNECTING ON LOAD OF EQUIPMENT ON LOW VOLTAGE AT NOMINAL CURRENT



PART NUMBER		<b>19200-11</b>	<b>19201-11</b>	<b>19202-11</b>	<b>19203-11</b>
	BLACK	<b>19210-11</b>	<b>19211-11</b>	<b>19212-11</b>	<b>19213-11</b>
	RED				
RATED CURRENT		16 A	25 A	32 A	40 A
MAX VOLTAGE		600 V	600 V	600 V	600 V
SHORT CIRCUIT RATING		5 KA	5 KA	5 KA	5 KA
MAXIMUM UL HORSEPOWER 3-PHASE (120V)		3	3	3	3
WIRE RANGE		16 - 6 AWG	16 - 6 AWG	16 - 6 AWG	16 - 6 AWG
TIGHTENING TORQUE		2 NM	2 NM	2 NM	2 NM

### SD1 SERIES ACCESSORIES

PART NUMBER	DESCRIPTION
<b>19440</b>	CONNECTOR 6-8 POLE
<b>19400-11</b>	DOOR INTERLOCK HANDLE BLACK
<b>19401-11</b>	EMERGENCY DOOR INTERLOCK HANDLE RED/YELLOW
<b>19535-100</b>	REMOTE OPERATOR SHAFT 100MM LENGTH
<b>19535-200</b>	REMOTE OPERATOR SHAFT 200MM LENGTH
<b>19535-300</b>	REMOTE OPERATOR SHAFT 300MM LENGTH
<b>19414*</b>	SD1 4TH POLE
<b>19423*</b>	SD1 AUX CONTACT SPST
<b>19421*</b>	SD1 GROUND POLE
<b>19419*</b>	SD1 NEUTRAL POLE

\*THESE MODULES INTEGRATE WITH THE DISCONNECT SWITCH. THEY ARE SEPARATE COMPONENTS THAT SCREW INTO THE MAIN SWITCHES FOR ADDITIONAL APPLICATIONS.



# DIN RAIL MOUNTED DISCONNECT SWITCHES

## SD-2 SERIES

### FEATURES

63-125A

ALLOW BREAKING AND DISCONNECTING ON LOAD OF EQUIPMENT ON LOW VOLTAGE AT NOMINAL CURRENT



PART NUMBER	BLACK	<b>19205-11</b>	<b>19206-11</b>	<b>19207-11</b>	<b>19208-11</b>
	RED	<b>19215-11</b>	<b>19216-11</b>	<b>19217-11</b>	<b>19208-11</b>
RATED CURRENT		63 A	80 A	100 A	125 A
MAX VOLTAGE		600 V	600 V	600 V	600 V
SHORT CIRCUIT RATING		5 kA	5 kA	5 kA	5 kA
MAXIMUM UL HORSEPOWER 3-PHASE (120V)		5	5	5	5
WIRE RANGE		6 - 1 AWG	6 - 1 AWG	6 - 1 AWG	6 - 1 AWG
TIGHTENING TORQUE		3.5 NM	3.5 NM	3.5 NM	3.5 NM

### SD2 SERIES ACCESSORIES

PART NUMBER	DESCRIPTION
<b>19440</b>	CONNECTOR 6-8 POLE
<b>19400-11</b>	DOOR INTERLOCK HANDLE BLACK
<b>19401-11</b>	EMERGENCY DOOR INTERLOCK HANDLE RED/YELLOW
<b>19535-100</b>	REMOTE OPERATOR SHAFT 100MM LENGTH
<b>19535-200</b>	REMOTE OPERATOR SHAFT 200MM LENGTH
<b>19535-300</b>	REMOTE OPERATOR SHAFT 300MM LENGTH
<b>19418*</b>	SD2 4TH POLE
<b>19429*</b>	SD2 AUX CONTACT SPST
<b>19422*</b>	SD2 GROUND POLE
<b>19420*</b>	SD2 NEUTRAL POLE

\*THESE MODULES INTEGRATE WITH THE DISCONNECT SWITCH. THEY ARE SEPARATE COMPONENTS THAT SCREW INTO THE MAIN SWITCHES FOR ADDITIONAL APPLICATIONS.



## CABLE GRIPS

CABLE GRIPS SECURE CABLES TO CONTROL CABINETS OR JUNCTION BOXES – PROVIDING STRAIN RELIEF AND PROTECTION FROM THE ELEMENTS. THEY ARE MADE OF METAL (NICKEL PLATED BRASS) OR PLASTIC (NYLON). ADVANTAGES EXIST FOR BOTH TYPES OF CABLE GRIP WITH THE NYLON VERSIONS BECOMING MORE POPULAR SINCE THEY CAN PROVIDE THE SAME LEVEL OF PROTECTION AGAINST DUST, DEBRIS AND WATER AS THE METALLIC VERSIONS – FOR LESS COST AND WEIGHT. CABLE GRIPS ARE SPECIFIED FIRST BY THE CABLE DIAMETER AND SECOND BY THREAD TYPE.

CABLE GRIPS ARE AVAILABLE IN THREE DIFFERENT THREAD TYPES, PG (PANZER GEWINDE, A GERMAN SPECIFIED THREAD WIDELY USED IN EUROPE), METRIC AND NPT (NATIONAL PIPE THREAD – USED IN USA). THIS IS USEFUL SINCE MOST SPECIFIERS THREAD THE CABINET HOLES SO THAT THE CABLE GRIP CAN BE SCREWED INTO IT FOR A MORE SECURE FIT. OTHERS SIMPLY KNOCKOUT A HOLE AND PLACE THE CABLE GRIP INSIDE IT.

OUR CABLE GRIPS ARE APPROVED BY UL AND LLOYDS OF LONDON AND ARE RATED IP 68, THE HIGHEST INGRESS PROTECTION AVAILABLE. INGRESS PROTECTION CONSISTS OF TWO NUMBERS – THE FIRST BETWEEN 0 AND 6, INDICATING THE RESISTANCE TO PARTICLES AND THE SECOND BETWEEN 0 AND 8, INDICATING RESISTANCE TO WATER. PLEASE SEE OUR CHART ON PAGE 84 EXPLAINING THE IP SYSTEM.



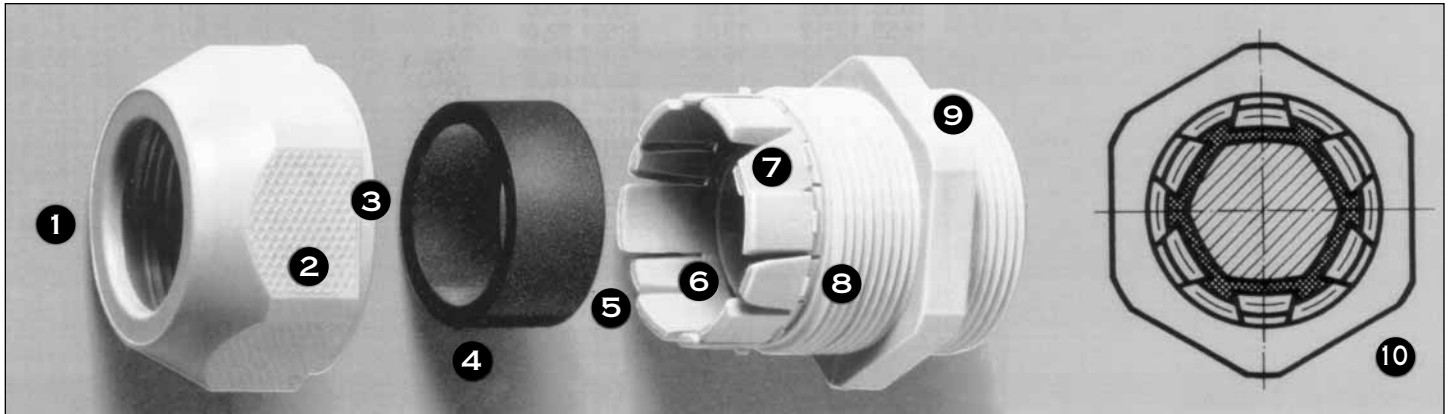

### MAIN FEATURES: CABLE GRIPS

- 1** **WIDER DOMED NUT WHICH CAN NOT BE OVER-TIGHTENED.**  
THE WIDE DOME DESIGN ALLOWS SPACE FOR THE NEOPRENE SEAL TO FORM A TIGHT GRIP ON THE CABLE, FORMING AN IP68 BARRIER. (PLEASE REFER TO INGRESS PROTECTION [IP] RATINGS ON THE BACK PAGE.)
- 2** **GENEROUS DEEP FLATS**  
THE DEEP FLATS ALLOW ENOUGH ROOM FOR THE PROPER WRENCH TO TIGHTEN OR LOOSEN THE CABLE GRIP WITHOUT THE WRENCH COMING OFF.
- 3** **SPACER**  
A SMALL SPACER EXISTS BETWEEN THE DOMED NUT AND THE LOCKING COLLETT, PROVIDING AN ADDITIONAL SEAL WHEN FULLY TIGHTENED.
- 4** **NEOPRENE RUBBER SEAL**  
THIS SEAL GRIPS AROUND THE CABLE TO FORM THE IP68 BARRIER WHEN PROPERLY TIGHTENED.
- 5** **WEBS ARE STAGGERED FOR BETTER GRIP**  
WEBS ARE DESIGNED IN AN ALTERNATING GEOMETRY WHICH ENHANCES GRIPPING CAPABILITY.
- 6** **STAGGERED WEBS**  
THE WEB DESIGN IS STAGGERED TO ALLOW FOR SEAL CONFORMITY AROUND THE CABLE TO MAXIMIZE THE PULL OUT RESISTANCE AND PROTECTION AGAINST THE ELEMENTS.
- 7** **SPRUNG WEBS**  
THE WEBS ARE DESIGNED SO THAT THEY WILL SPRING BACK TO THEIR ORIGINAL OPEN POSITION MAKING INSTALLATION EASY WHILE MAINTAINING THE SEAL QUALITY.
- 8** **RETENTION SPRINGS FOR DOMED NUT**  
THE 'TIGHT SEAL' DESIGN ALLOWS THE DOMED NUT TO LOCK WITH THE COLLETT BEFORE ANY THREADS ARE ENGAGED. THIS GUARDS AGAINST MISTHEADS AS WELL AS AIDS IN THE INSTALLATION PROCESS.
- 9** **SEALING LIP**  
THE COLLETT DESIGN INCORPORATES A SEALING LIP WHICH PROVIDES FOR A POSITIVE SEAL AGAINST THE ENCLOSURE.
- 10** **ANTI-TWIST CABLE LOCKING COLLETT**  
THE ENTIRE DESIGN OF THE 'TIGHT SEAL' PRODUCT LINE INSURES THAT CABLES WILL NOT TWIST OR TURN ONCE LOCKED DOWN.

### TECHNICAL DATA

#### MATERIAL:

POLYAMIDE PA 6, SELF-EXTINGUISHING,  
HALOGEN-FREE

#### SEAL:

NEOPRENE, OIL AND PETROLEUM RESISTANT

#### OPERATING TEMPERATURE:

STATIC: -40°C TO 100°C, SHORT-TERM 120°C  
DYNAMIC: -30°C TO 80°C, SHORT-TERM 100°C

WEATHER RESISTANCE GOOD

#### STRAIN RELIEF:

SMOOTH ACTION

#### SAFETY CLASS:

IP68, WATERPROOF (5 BAR)

#### PATENTS:

EUROPE, USA, JAPAN

#### VDE TEST REPORT:

12 796-9000-4001/A 2 J.

UL TEST (UNDERWRITERS LABORATORIES INC.)

LLOYD'S REGISTER OF SHIPPING CERTIFICATE

GERMANISCHE LLOYD CERTIFICATE

## CABLE GRIPS

### KNOCKOUT HOLE REFERENCE CHART

PG	MM	INCHES	METRIC	MM	INCHES
7	12.5	0.492	12	12	0.472
9	15.2	0.598	16	16	0.63
11	18.6	0.732	20	20	0.787
13.5	20.4	0.803	25	25	0.984
16	22.5	0.886	32	32	1.26
21	28.3	1.114	40	40	1.575
29	37	1.457	50	50	1.969
36	47	1.85	63	63	2.48
42	54	2.126			
48	59.3	2.338			





# INGRESS PROTECTION (IP) RATINGS

## LIST OF PROTECTION CLASSES

### IP PROTECTION CLASSES TO DIN 40 050 SHEET 1

UP TO 1000 VAC AND 1500 VDC (UTE STANDARD C 200 10)

## IP RATINGS CONSIST OF A TWO DIGIT NUMBER EXPLAINED BELOW:

THE TWO DIGITS CORRESPOND TO THE DESCRIPTION BY DIN 40 050 SHEET 1, IEC 144 AND 525 AS WELL AS UTE C 200 10.

### 1ST DIGIT DEGREE OF PROTECTION AGAINST TOUCHING AND FOREIGN MATTER

#### IP SPECIFICATIONS

- 0** NO PROTECTION.
- 1** PROTECTION AGAINST PENETRATION BY SOLID FOREIGN MATTERS LARGER THAN 50 MM (ACCIDENTAL TOUCHING BY HAND).
- 2** PROTECTION AGAINST PENETRATION BY SOLID FOREIGN MATTERS LARGER THAN 12 MM (TOUCHING WITH FINGERS).
- 3** PROTECTION AGAINST PENETRATION BY SOLID FOREIGN MATTERS LARGER THAN 2.5 MM (TOUCHING WITH TOOLS, WIRES LARGER THAN 2.5 MM).
- 4** PROTECTION AGAINST SOLID FOREIGN MATTERS LARGER THAN 1 MM (TOUCHING WITH TOOLS, WIRES LARGER THAN 1 MM).
- 5** COMPLETE PROTECTION FROM BEING TOUCHED. PROTECTION FROM HARMFUL DUST DEPOSITS - DUST PENETRATION IS NOT COMPLETELY PREVENTED.
- 6** COMPLETE PROTECTION FROM BEING TOUCHED. PROTECTION AGAINST PENETRATION BY DUST.

### 2ND DIGIT DEGREE OF PROTECTION AGAINST WATER

#### IP SPECIFICATIONS

- 0** NO PROTECTION.
- 1** PROTECTION AGAINST VERTICALLY DRIPPING WATER.
- 2** PROTECTION AGAINST DRIP WATER FALLING AT AN ANGLE OF UP TO 15 DEGREES.
- 3** PROTECTION AGAINST SPRAY WATER FALLING AT AN ANGLE OF UP TO 60 DEGREES.
- 4** PROTECTION AGAINST SPRAY WATER FROM ALL DIRECTIONS.
- 5** PROTECTION AGAINST WATER JETS FROM ALL DIRECTIONS
- 6** PROTECTION AGAINST TEMPORARY FLOODING, E.G., BY ROUGH SEA.
- 7** PROTECTION WHEN SUBMERSED IN WATER AT SPECIFIED PRESSURE AND UNSPECIFIED DURATION.
- 8** PROTECTION WHEN SUBMERSED IN WATER AT ELEVATED PRESSURE AND UNSPECIFIED TIME.

## USE AND APPLICATION OF NYLON CABLE GRIPS

1. THE USE OF SYNTHETIC - CABLE GRIPS IS ALMOST UNLIMITED WITHIN THE ELECTRICAL AND ELECTRONICS INDUSTRY. INSTALLATIONS WHERE CABLES MUST BE LED SAFELY THROUGH A WALL OF AN ENCLOSURE WILL BE SPECIFIED WITH CABLE GRIPS. SYNTHETIC CABLE GRIPS ARE SPECIFIED TO:

- **SECURE THE CABLE** TO THE ENCLOSURE'S WALL TO PROVIDE EXCELLENT PULL-OUT RESISTANCE.
- **SEAL AND PROTECT** THE INSIDE OF THE ENCLOSURE FROM THE UNWANTED AFFECTS OF THE ENVIRONMENT. THESE CONTAMINANTS MAY BE WATER, GAS, CHEMICALS VAPORS, OR FUMES.
- **REDUCE MATERIAL COST** DUE TO USE OF LIGHTER, LESS EXPENSIVE MATERIALS, AS WELL AS, ELIMINATING THE NEED FOR RUNNING CONDUIT.

2. SOME OF THE TYPICAL APPLICATIONS USING CABLE GRIPS ARE:

- MACHINERY
- PROCESS EQUIPMENT ENGINEERING
- APPARATUS AND APPLIANCE CONSTRUCTION
- AIRCRAFT AND AUTOMOTIVE ENGINEERING
- LOCOMOTIVE ENGINEERING
- ELEVATOR ENGINEERING
- PLANT ENGINEERING
- CHEMICAL AND PHARMACEUTICAL INDUSTRIES
- REFINERIES
- NUCLEAR RESEARCH INSTITUTIONS
- PROCESS AUTOMATION AND PROCESS ENGINEERING
- INDOOR AND OUTDOOR ELECTRICAL INSTALLATIONS
- SWITCHGEAR AND DISTRIBUTION CONSTRUCTION
- EQUIPMENT FOR MILITARY PURPOSES
- MUNICIPAL AND UTILITY TYPE APPLICATIONS, SUCH AS POWER, ELECTRICITY AND GAS WORKS

# CABLE GRIPS NICKEL-PLATED BRASS

THREAD: METRIC

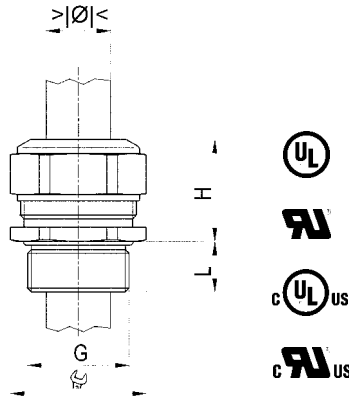

MATERIAL : NICKEL-PLATED BRASS  
 SEAL: TPE  
 STRAIN RELIEF: ACC. TO EN 50262, VERSION A  
 TEMP. RANGE: -40°/+100°C  
 PROTECTION CLASS: IP 68

PART NUMBER	SIZE	CABLE DIAM. MM	WRENCH SIZE	H MM	L MM	STD. PKG. SIZE
-------------	------	----------------	-------------	------	------	----------------

SHORT, ONE-PIECE SEALING INSERT  
 LONG ENTRY THREAD METRIC  
 (NOT OVERALL LENGTH INSULATED)

1100.06.025	M 6x1.0 <sup>1</sup>	2.0-2.5	8	12	8	50
1100.06.030	M 6x1.0 <sup>1</sup>	2.5-3.0	8	12	8	50
1100.06.035	M 6x1.0 <sup>1</sup>	3.0-3.5	8	12	8	50
1100.08.035	M 8x1.25 <sup>1</sup>	2.5-3.5	11	14	10	50
1100.08.050	M 8x1.25 <sup>1</sup>	3.5-5.0	11	14	10	50
1100.10.040	M10x1.5 <sup>1</sup>	3.0-4.0	13	15	10	50
1100.10.060	M10x1.5	4.0-6.0	13	15	10	50
1100.12.050	M12x1.5	3.5-5.0	15	17	10	50
1100.12.065	M12x1.5	5.0-6.5	15	17	10	50
1100.12.080	M12x1.5	6.5-8.0	15	17	10	50
1100.17.045	M16x1.5	3.5-4.5	18	20	10	50
1100.17.060	M16x1.5	4.5-6.0	18	20	10	50
1100.17.080	M16x1.5	6.0-8.0	18	20	10	50
1100.17.105	M16x1.5	8.0-10.5	18	22	10	50
1100.20.080	M20x1.5	6.0-8.0	24	21	10	50
1100.20.110	M20x1.5	8.0-11.0	24	21	10	50
1100.20.150	M20x1.5	11.0-15.0	24	23	10	50
1100.25.125	M25x1.5	9.5-12.5	30	25	11	25
1100.25.160	M25x1.5	12.5-16.0	30	25	11	25
1100.25.205	M25x1.5	16.0-20.5	30	28	11	25
1100.32.170	M32x1.5	14.0-17.0	36	28	13	25
1100.32.210	M32x1.5	17.0-21.0	36	28	13	25
1100.32.255	M32x1.5	21.0-25.5	36	28	13	25
1100.40.240	M40x1.5	20.0-24.0	46	31	13	10
1100.40.285	M40x1.5	24.0-28.5	46	31	13	10
1100.40.330	M40x1.5	28.5-33.0	46	31	13	10
1100.50.330	M50x1.5	29.0-33.0	55	34	14	10
1100.50.370	M50x1.5	33.0-37.0	55	34	14	10
1100.50.420	M50x1.5	37.0-42.0	55	34	14	10
1100.63.400	M63x1.5	35.0-40.0	70	37	14	5
1100.63.460	M63x1.5	40.0-46.0	70	37	14	5
1100.63.520	M63x1.5	46.0-52.0	70	37	14	5
1100.75.500	M75x1.5	45.0-50.0	80	38	15	1
1100.75.560	M75x1.5	50.0-56.0	80	38	15	1
1100.75.630	M75x1.5	56.0-63.0	80	38	15	1

<sup>1</sup> METRIC COARSE PITCH THREAD



## CABLE GRIPS NICKEL-PLATED BRASS

THREAD: PG

MATERIAL : NICKEL-PLATED BRASS  
 SEAL: TPE  
 TEMP. RANGE: -40°/-100°C  
 PROTECTION CLASS: IP 68

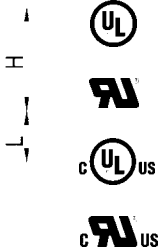
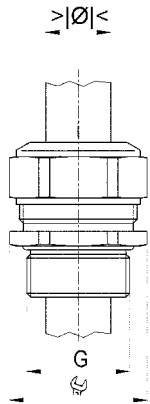

PART NUMBER	SIZE	CABLE DIAM. MM	WRENCH SIZE	H MM	L MM	STD. PKG. SIZE
LONG, ONE-PIECE SEALING INSERT SHORT ENTRY THREAD PG (OVERALL LENGTH INSULATED)						
<b>1100.07.050</b>	PG 7	3.5-5.0	15	17	10	50
<b>1100.07.065</b>	PG 7	5.0-6.5	15	17	10	50
<b>1100.07.080</b>	PG 7	6.5-8.0	15	17	10	50
<b>1100.09.045</b>	PG 9	3.5-4.5	18	20	10	50
<b>1100.09.060</b>	PG 9	4.5-6.0	18	20	10	50
<b>1100.09.080</b>	PG 9	6.0-8.0	18	20	10	50
<b>1100.09.105</b>	PG 9	8.0-10.5	18	22	10	50
<b>1100.11.055</b>	PG 11	4.0-5.5	21	21	10	50
<b>1100.11.085</b>	PG 11	5.5-8.5	21	21	10	50
<b>1100.11.120</b>	PG 11	8.5-12.0	21	21	10	50
<b>1100.13.080</b>	PG 13	6.0-8.0	24	21	10	50
<b>1100.13.110</b>	PG 13	8.0-11.0	24	21	10	50
<b>1100.13.150</b>	PG 13	11.0-15.0	24	23	10	50
<b>1100.16.080</b>	PG 16	6.0-8.0	24	23	10	50
<b>1100.16.110</b>	PG 16	8.0-11.0	24	23	10	50
<b>1100.16.150</b>	PG 16	11.0-15.0	24	23	10	50
<b>1100.21.125</b>	PG 21	9.5-12.5	30	28	12	25
<b>1100.21.160</b>	PG 21	12.5-16.0	30	28	12	25
<b>1100.21.205</b>	PG 21	16.0-20.5	30	28	12	25
<b>1100.29.190</b>	PG 29	16.0-19.0	38	28	12	25
<b>1100.29.230</b>	PG 29	19.0-23.0	38	28	12	25
<b>1100.29.275</b>	PG 29	23.0-27.5	38	28	12	25
<b>1100.36.260</b>	PG 36	21.5-26.0	50	32	15	10
<b>1100.36.305</b>	PG 36	26.0-30.5	50	32	15	10
<b>1100.36.350</b>	PG 36	30.5-35.0	50	32	15	10
<b>1100.42.330</b>	PG 42	29.0-33.0	55	34	15	10
<b>1100.42.370</b>	PG 42	33.0-37.0	55	34	15	10
<b>1100.42.420</b>	PG 42	37.0-42.0	55	34	15	10
<b>1100.48.370</b>	PG 48	32.0-37.0	65	37	15	10
<b>1100.48.430</b>	PG 48	37.0-43.0	65	37	15	10
<b>1100.48.490</b>	PG 48	43.0-49.0	65	37	15	10

## SYNTHETIC CABLE GRIPS

WITH LAMELLAR TECHNOLOGY

SYNTEC®

THREAD: METRIC, NPT

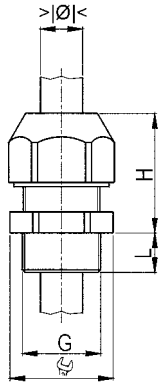

MATERIAL: POLYAMIDE PA6  
 SEAL: CR (NEOPRENE)  
 STRAIN RELIEF: ACC. TO EN 50262, VERSION A  
 TEMP. RANGE: -30°/+80°C  
 PROTECTION CLASS: IP 68

PART NUMBER	SIZE	CABLE DIAM. MM	WRENCH SIZE	H MM	L MM	COLOR	STD. PKG. SIZE
-------------	------	----------------	-------------	------	------	-------	----------------

SHORT ENTRY THREAD METRIC

1555.12.06	M12x1.5	2.5-6.5	15	21	6	GREY	100
1555.17.08	M16x1.5	4.0-8.0	19	23	6	GREY	50
1555.20.07	M20x1.5	3.0-7.0	24	26	8	GREY	50
1555.20.12	M20x1.5	5.5-12.0	24	26	8	GREY	50
1555.25.14	M25x1.5	8.0-14.0	33	35	8	GREY	25
1555.25.18	M25x1.5	11.0-18.0	33	35	8	GREY	25
1555.32.25	M32x1.5	17.0-25.0	42	36	10	GREY	20

1545.12.06	M12x1.5	2.5-6.5	15	21	6	BLACK	100
1545.17.08	M16x1.5	4.0-8.0	19	23	6	BLACK	50
1545.20.07	M20x1.5	3.0-7.0	24	26	8	BLACK	50
1545.20.12	M20x1.5	5.5-12.0	24	26	8	BLACK	50
1545.25.14	M25x1.5	8.0-14.0	33	35	8	BLACK	25
1545.25.18	M25x1.5	11.0-18.0	33	35	8	BLACK	25
1545.32.25	M32x1.5	17.0-25.0	42	36	10	BLACK	20

MATERIAL: POLYAMIDE PA6  
 SEAL: CR (NEOPRENE)  
 TEMP. RANGE: -30°/+80°C  
 PROTECTION CLASS: IP 68

NPT NYLON CABLE GRIPS HAVE GALVANIZED STEEL LOCKNUTS

PART NUMBER	SIZE	CABLE SIZE	WRENCH SIZE	H MM	L MM	COLOR	STD. PKG. SIZE
-------------	------	------------	-------------	------	------	-------	----------------

ENTRY THREAD NPT

1555.N0375.08	NPT 1/8"	3.0-8.0	19/22	23	15	GREY	50
1555.N0500.07	NPT 1/2"	3.0-7.0	24	26	15	GREY	50
1555.N0500.12	NPT 1/2"	5.5-12.0	24	26	15	GREY	50
1555.N0750.14	NPT 3/4"	6.5-14.0	33	35	15	GREY	25
1555.N0750.18	NPT 3/4"	11.0-18.0	33	35	15	GREY	25
1555.N1000.22	NPT 1"	17.0-22.0	42	36	15	GREY	20

1545.N0375.08	NPT 3/8"	3.0-8.0	19/22	23	15	BLACK	50
1545.N0500.07	NPT 1/2"	3.0-7.0	24	26	15	BLACK	50
1545.N0500.12	NPT 1/2"	5.5-12.0	24	26	15	BLACK	50
1545.N0750.14	NPT 3/4"	6.5-14.0	33	35	15	BLACK	25
1545.N0750.18	NPT 3/4"	11.0-18.0	33	35	15	BLACK	25
1545.N1000.22	NPT 1"	17.0-22.0	42	36	15	BLACK	20



## SYNTHETIC CABLE GRIPS

WITH LAMELLAR TECHNOLOGY

SYNTEC®

THREAD: PG

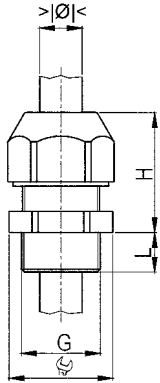

MATERIAL: POLYAMIDE PA6  
 SEAL: CR (NEOPRENE)  
 TEMP. RANGE: -30°/+80°C  
 PROTECTION CLASS: IP 68

PART NUMBER	SIZE	CABLE DIAM. MM	WRENCH SIZE	H MM	L MM	COLOR	STD. PKG. SIZE
-------------	------	----------------	-------------	------	------	-------	----------------

ENTRY THREAD PG

<b>1545.07.06</b>	PG 7	2.5-6.5	15	21	8	BLACK	100
<b>1545.09.08</b>	PG 9	3.0-8.0	19	23	8	BLACK	50
<b>1545.11.07</b>	PG 11	2.0-7.0	22	25	8	BLACK	50
<b>1545.11.10</b>	PG 11	4.0-10.0	22	25	8	BLACK	50
<b>1545.13.07</b>	PG 13	3.0-7.0	24	26	9	BLACK	50
<b>1545.13.12</b>	PG 13	5.5-12.0	24	26	9	BLACK	50
<b>1545.16.11</b>	PG 16	5.0-11.0	27	30	10	BLACK	50
<b>1545.16.14</b>	PG 16	8.5-14.0	27	30	10	BLACK	50
<b>1545.21.14</b>	PG 21	6.5-14.0	33	35	11	BLACK	25
<b>1545.21.18</b>	PG 21	11.0-18.0	33	35	11	BLACK	25
<b>1545.29.25</b>	PG 29	17.0-25.0	42	36	11	BLACK	20
<b>1545.36.33</b>	PG 36	22.0-33.0	53	48	15	BLACK	10
<b>1545.42.38</b>	PG 42	28.0-38.0	60	48	15	BLACK	5
<b>1545.48.44</b>	PG 48	32.0-44.0	65	48	15	BLACK	5

MATERIAL: POLYAMIDE PA6  
 SEAL: CR (NEOPRENE)  
 TEMP. RANGE: -30°/+80°C  
 PROTECTION CLASS: IP 68

PART NUMBER	SIZE	CABLE DIAM. MM	WRENCH SIZE	H MM	L MM	COLOR	STD. PKG. SIZE
-------------	------	----------------	-------------	------	------	-------	----------------

ENTRY THREAD PG

<b>1555.07.06</b>	PG 7	2.5-6.5	15	21	8	GREY	100
<b>1555.09.08</b>	PG 9	3.0-8.0	19	23	8	GREY	50
<b>1555.11.07</b>	PG 11	2.0-7.0	22	25	8	GREY	50
<b>1555.11.10</b>	PG 11	4.0-10.0	22	25	8	GREY	50
<b>1555.13.07</b>	PG 13	3.0-7.0	24	26	9	GREY	50
<b>1555.13.12</b>	PG 13	5.5-12.0	24	26	9	GREY	50
<b>1555.16.11</b>	PG 16	5.0-11.0	27	30	10	GREY	50
<b>1555.16.14</b>	PG 16	8.5-14.0	27	30	10	GREY	50
<b>1555.21.14</b>	PG 21	6.5-14.0	33	35	11	GREY	25
<b>1555.21.18</b>	PG 21	11.0-18.0	33	35	11	GREY	25
<b>1555.29.25</b>	PG 29	17.0-25.0	42	36	11	GREY	20
<b>1555.36.33</b>	PG 36	22.0-33.0	53	48	15	GREY	10
<b>1555.42.38</b>	PG 42	28.0-38.0	60	48	15	GREY	5
<b>1555.48.44</b>	PG 48	32.0-44.0	65	48	15	GREY	5



## SYNTHETIC CABLE GRIPS

WITH LAMELLAR TECHNOLOGY  
AND ANTI-KINK NOZZLE SYNTEC®

THREAD: PG

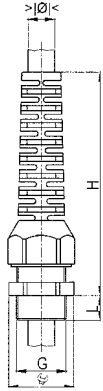

MATERIAL: POLYAMIDE PA6  
SEAL: CR(NEOPRENE)  
TEMP. RANGE: -30°/+80°C  
PROTECTION CLASS: IP 68

PART NUMBER	SIZE	CABLE DIAM. MM	WRENCH SIZE	H MM	L MM	COLOR	STD. PKG. SIZE
-------------	------	----------------	-------------	------	------	-------	----------------

ENTRY THREAD PG

<b>1576.07.06</b>	PG 7	2.5-6.5	15	54	8	GREY	50
<b>1576.09.08</b>	PG 9	3.0-8.0	19	64	8	GREY	50
<b>1576.11.07</b>	PG 11	2.0-7.0	22	77	8	GREY	50
<b>1576.11.10</b>	PG 11	4.0-10.0	22	77	8	GREY	50
<b>1576.13.07</b>	PG 13	3.0-7.0	24	88	9	GREY	50
<b>1576.13.12</b>	PG 13	5.5-12.0	24	88	9	GREY	50
<b>1576.16.11</b>	PG 16	5.0-11.0	27	102	10	GREY	50
<b>1576.16.14</b>	PG 16	8.5-14.0	27	102	10	GREY	50

<b>1546.07.06</b>	PG 7	2.5-6.5	15	54	8	BLACK	50
<b>1546.09.08</b>	PG 9	3.0-8.0	19	64	8	BLACK	50
<b>1546.11.07</b>	PG 11	2.0-7.0	22	77	8	BLACK	50
<b>1546.11.10</b>	PG 11	4.0-10.0	22	77	8	BLACK	50
<b>1546.13.07</b>	PG 13	3.0-7.0	24	88	9	BLACK	50
<b>1546.13.12</b>	PG 13	5.5-12.0	24	88	9	BLACK	50
<b>1546.16.11</b>	PG 16	5.0-11.0	27	102	10	BLACK	50
<b>1546.16.14</b>	PG 16	8.5-14.0	27	102	10	BLACK	50



## LOCK-NUTS METALLIC

THREAD: METRIC, PG, NPT

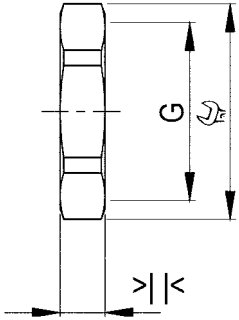

MATERIAL: NICKEL-PLATED BRASS  
TYPE: HEXAGONAL DESIGN



PART NUMBER	SIZE	WRENCH SIZE	MM	STD. PKG. SIZE
-------------	------	-------------	----	----------------

THREAD METRIC

<b>8000.06</b>	M 6x1.0 <sup>1</sup>	9	2.8	50
<b>8000.08</b>	M 8x1.25 <sup>1</sup>	11	2.8	50
<b>8000.10</b>	M 10x1.5 <sup>1</sup>	13	2.8	50
<b>8000.12</b>	M 12x1.5	15	3.0	50
<b>8000.17</b>	M 16x1.5	19	3.0	50
<b>8000.20</b>	M 20x1.5	24	3.5	50
<b>8000.25</b>	M 25x1.5	30	3.5	25
<b>8000.32</b>	M 32x1.5	36	4.5	10
<b>8000.40</b>	M 40x1.5	46	4.5	10
<b>8000.50</b>	M 50x1.5	55	5.5	10
<b>8000.63</b>	M 63x1.5	70	6.0	10
<b>8000.75</b>	M 75x1.5	80	6.0	5

1 METRIC COARSE PITCH THREAD  
2 METRIC THREAD ACC. TO EN60423

THREAD PG



<b>8007</b>	PG 7	15	2.8	50
<b>8009</b>	PG 9	18	2.8	50
<b>8011</b>	PG 11	21	3.0	50
<b>8013</b>	PG 13	23	3.0	50
<b>8016</b>	PG 16	26	3.0	50
<b>8021</b>	PG 21	32	3.5	25
<b>8029</b>	PG 29	41	4.0	10
<b>8036</b>	PG 36	51	5.0	10
<b>8042</b>	PG 42	60	5.0	10
<b>8048.48</b>	PG 48	64	5.5	10

MATERIAL: GALVANIZED STEEL  
THREAD NPT



<b>0375.LN</b>	3/8"	3/8"		1
<b>0500.LN</b>	1/2"	1/2"		1
<b>0750.LN</b>	3/4"	3/4"		1
<b>01000.LN</b>	1"	1"		1

# LOCK-NUTS SYNTHETIC

THREAD: METRIC, PG

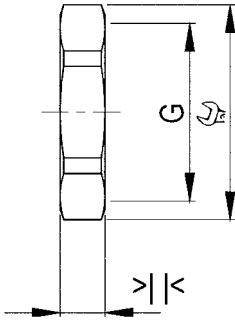

MATERIAL: POLYAMIDE, GLASS-FIBER REINFORCED  
 TEMP. RANGE: -20°/+100°C



PART NUMBER	SIZE	WRENCH SIZE	MM	COLOR	STD. PKG. SIZE
-------------	------	-------------	----	-------	----------------

THREAD METRIC

<b>8212</b>	M12x1.5	17	5.0	GREY	100
<b>8217</b>	M16x1.5	19	6.5	GREY	100
<b>8220</b>	M20x1.5	26	7.0	GREY	100
<b>8225</b>	M25x1.5	32	9.0	GREY	100
<b>8232</b>	M32x1.5	41	9.0	GREY	100
<b>8240</b>	M40x1.5	45	11.0	GREY	50
<b>8250</b>	M50x1.5	59	11.0	GREY	10
<b>8263</b>	M63x1.5	72	13.0	GREY	10

THREAD PG



<b>8207</b>	PG 7	19	5.5	GREY	100
<b>8209</b>	PG 9	22	5.5	GREY	100
<b>8211</b>	PG 11	24	5.0	GREY	100
<b>8213</b>	PG 13	27	6.0	GREY	100
<b>8216</b>	PG 16	30	6.0	GREY	100
<b>8221</b>	PG 21	36	7.5	GREY	100
<b>8229</b>	PG 29	46	7.5	GREY	50
<b>8236</b>	PG 36	60	8.5	GREY	25
<b>8242</b>	PG 42	65	8.5	GREY	25
<b>8248</b>	PG 48	70	8.5	GREY	25



## LOCKING PLUGS NICKEL-PLATED BRASS

THREAD: METRIC, PG

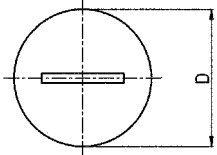
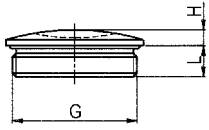

MATERIAL: NICKEL-PLATED BRASS  
 O-RING: NBR  
 FEATURES: FLANGED TYPE AND WITH O-RING  
 O-RING  
 TEMP. RANGE: -20°/+100°C  
 PROTECTION CLASS: IP 68

PART NUMBER	SIZE	CABLE DIAM. MM	H MM	L MM	STD. PKG. SIZE
-------------	------	----------------	------	------	----------------

SHORT ENTRY THREAD METRIC  
 WITH O-RING

<b>8706.08</b>	M 6X1.0	9	3	5	50
<b>8708.08</b>	M 8X1.25	10	3	5	50
<b>8710.08</b>	M10X1.5	12	3	5	50
<b>8712.08</b>	M12X1.5	14	3	5	50
<b>8717.08</b>	M16X1.5	19	3	5	50
<b>8720.08</b>	M20X1.5	24	3	6	25
<b>8725.08</b>	M25X1.5	28	4	7	25
<b>8732.08</b>	M32X1.5	35	4	8	10
<b>8740.08</b>	M40X1.5	45	6	8	10
<b>8750.08</b>	M50X1.5	55	6	9	10
<b>8763.08</b>	M63X1.5	70	6	10	10
<b>8775.08</b>	M75X1.5	80	6	11	5

PART NUMBER	SIZE	CABLE DIAM. MM	H MM	L MM	STD. PKG. SIZE
-------------	------	----------------	------	------	----------------

SHORT ENTRY THREAD PG  
 WITH O-RING

<b>8707.08</b>	PG 7	14	3	5.0	100
<b>8709.08</b>	PG 9	17	3	6.0	100
<b>8711.08</b>	PG 11	20	3	6.0	100
<b>8713.08</b>	PG 13	22	3	6.5	50
<b>8716.08</b>	PG 16	24	3	6.5	50
<b>8721.08</b>	PG 21	30	4	7.0	10
<b>8729.08</b>	PG 29	39	4	8.0	10
<b>8736.08</b>	PG 36	50	6	9.0	10
<b>8742.08</b>	PG 42	60	6	10.0	10
<b>8748.08</b>	G2"	65	6	10.0	10
<b>8748.48.08</b>	PG 48	65	6	10.0	10

# LOCKING PLUGS SYNTHETIC

THREAD: METRIC, PG

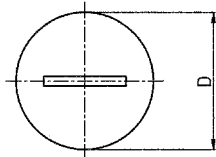
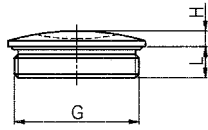

MATERIAL: POLYSTYROL, SHOCK RESISTANT  
 FEATURES: FLANGED TYPE  
 TEMP. RANGE: -20°/+80°C  
 PROTECTION CLASS: IP 54

PART NUMBER	SIZE	CABLE DIAM. MM	H MM	L MM	COLOR	STD. PKG. SIZE
-------------	------	----------------	------	------	-------	----------------

SHORT ENTRY THREAD METRIC  
 WITHOUT O-RING

<b>8812</b>	M12X1.5	15	4	6	GREY	100
<b>8817</b>	M16X1.5	20	5	7	GREY	100
<b>8820</b>	M20X1.5	24	5	7	GREY	100
<b>8825</b>	M25X1.5	30	4	11	GREY	100
<b>8832</b>	M32X1.5	37	5	11	GREY	100
<b>8840</b>	M40X1.5	46	6	12	GREY	50
<b>8850</b>	M50X1.5	55	7	13	GREY	25
<b>8863</b>	M63X1.5	69	6	14	GREY	10

SHORT ENTRY THREAD PG  
 WITHOUT O-RING

<b>8807</b>	PG 7	14	3	5	GREY	100
<b>8809</b>	PG 9	20	3	6	GREY	100
<b>8811</b>	PG 11	22	3	6	GREY	100
<b>8813</b>	PG 13	25	4	6	GREY	100
<b>8816</b>	PG 16	27	4	6	GREY	100
<b>8821</b>	PG 21	33	4	8	GREY	100
<b>8829</b>	PG 29	44	4	8	GREY	50
<b>8836</b>	PG 36	55	4	10	GREY	25
<b>8848</b>	PG 48	69	6	12	GREY	25



## CROSS REFERENCE

### HEYCO - AGRO

HEYCO - PG THREAD TYPE			AGRO - PG THREAD TYPE			
------------------------	--	--	-----------------------	--	--	--

THREAD TYPE	HEYCO BLACK	HEYCO GREY	DIAMETER RANGE (MM)	DIAMETER RANGE (MM)	AGRO BLACK	AGRO GREY
PG7	3207	3208	2.3 - 6.4	2.5 - 6.5	1545.07.06	1555.07.06
PG7	3444	3445	2.0 - 4.	2.5 - 6.5	1545.07.06	1555.07.06
PG9	3210	3211	4.7 - 7.6	3.0 - 8.0	1545.09.08	1555.09.08
PG9	3446	3447	3.0 - 5.8	3.0 - 8.0	1545.09.08	1555.09.08
PG11	3213	3214	5.9 - 10.0	4.0 - 10.0	1545.11.10	1555.11.10
PG11	3448	3449	3.8 - 7.0	2.0 - 7.0	1545.11.07	1555.11.07
PG13	3216	3217	6.9 - 11.9	5.5 - 12.0	1545.13.12	1555.13.12
PG13	3450	3451	5.0 - 8.8	3.0 - 7.0	1545.13.07	1555.13.07
PG16	3219	3220	10.9 - 13.9	8.5 - 14.0	1545.16.14	1555.16.14
PG16	3452	3453	8.1 - 11.9	5.0 - 11.0	1545.16.11	1555.16.11
PG21	3222	3223	13.8 - 18.0	11.0 - 18.0	1545.21.18	1555.21.18
PG21	3454	3455	11.6 - 16.0	6.5 - 14.0	1545.21.14	1555.21.14
PG29	3225	3226	18.3 - 24.5	17.0 - 25.0	1545.29.25	1555.29.25
PG29	3456	3457	16.3 - 19.6	17.0 - 25.0	1545.29.25	1555.29.25
PG36	3204	N/A	22.0 - 32.0	22.0 - 33.0	1545.36.33	1555.36.33
PG36	3206	N/A	20.0 - 26.0	22.0 - 33.0	1545.36.33	1555.36.33
PG42	3212	N/A	32.0 - 38.0	28.0 - 38.0	1545.42.38	1545.42.38
PG42	3218	N/A	25.0 - 31.0	28.0 - 38.0	1545.42.38	1545.42.38
PG48	3281	N/A	37.0 - 44.0	32.0 - 44.0	1545.48.44	1545.48.44
PG48	3283	N/A	29.0 - 35.0	32.0 - 44.0	1545.48.44	1545.48.44

HEYCO - NPT THREAD TYPE			AGRO - NPT THREAD TYPE			
-------------------------	--	--	------------------------	--	--	--

THREAD TYPE	HEYCO BLACK	HEYCO GREY	DIAMETER RANGE (MM)	DIAMETER RANGE (MM)	AGRO BLACK	AGRO GREY
NPT 3/8	3228	3229	4.7 - 7.9	3.0 - 8.0	1545.N0375.08	1555.N0375.08
NPT 3/8	3458	3459	2.0 - 6.0	3.0 - 8.0	1545.N0375.08	1555.N0375.08
NPT 1/2	3231	3232	6.9 - 11.8	5.5 - 12.0	1545.N0500.12	1555.N0500.12
NPT 1/2	3224	3236	5.0 - 8.8	3.0 - 7.0	1545.N0500.07	1555.N0500.07
NPT 3/4	3234	3235	13.8 - 18.0	11.0 - 18.0	1545.N0750.18	1555.N0750.18
NPT 3/4	3460	3461	11.5 - 16.0	6.5 - 14.0	1545.N0750.14	1555.N0750.14
NPT 1	8437	8438	18.0 - 25.4	17.0 - 22.0	1545.N1000.22	1555.N1000.22
NPT 1	8439	8440	12.0 - 19.5	17.0 - 22.0	1545.N1000.22	1555.N1000.22

HEYCO - STRAIN RELIEF			AGRO - STRAIN RELIEF			
-----------------------	--	--	----------------------	--	--	--

THREAD TYPE	HEYCO BLACK	HEYCO GREY	DIAMETER RANGE (MM)	DIAMETER RANGE (MM)	AGRO BLACK	AGRO GREY
PG7	3237	3228	2.3 - 6.4	2.5 - 6.5	1576.07.06	1546.07.06
PG7	3464	3464	2.0 - 4.6	2.5 - 6.5	1576.07.06	1546.07.06
PG9	3240	3241	4.7 - 7.6	3.0 - 8.0	1576.09.08	1546.09.08
PG9	3466	3467	3.0 - 5.8	3.0 - 8.0	1576.09.08	1546.09.08
PG11	3243	3244	5.9 - 10.0	4.0 - 10.0	1576.11.10	1546.11.10
PG11	3468	3469	3.8 - 7.0	2.0 - 7.0	1576.11.07	1546.11.07
PG13	3246	3247	6.9 - 11.9	5.5 - 12.0	1576.13.12	1546.13.12
PG13	3470	3471	5.0 - 8.8	3.0 - 7.0	1576.13.07	1546.13.07
PG16	3249	3250	10.9 - 13.9	8.5 - 14.0	1576.16.14	1546.16.14
PG16	3472	3473	8.1 - 11.9	5.0 - 11.0	1576.16.11	1546.16.11

## CROSS REFERENCE

### OLFLEX - AGRO

OLFLEX - PG THREAD TYPE				AGRO - PG THREAD TYPE			
THREAD TYPE	OLFLEX BLACK	OLFLEX GREY	DIAMETER RANGE (MM)	DIAMETER RANGE (MM)	AGRO BLACK	AGRO GREY	
PG7	S2207	S1207	2.0 - 5.0	2.5 - 6.5	1545.07.06	1555.07.06	
PG7	S2107	S1107	3.0 - 6.5	2.5 - 6.5	1545.07.06	1555.07.06	
PG9	S2209	S1209	2.0 - 6.0	3.0 - 8.0	1545.09.08	1555.09.08	
PG9	S2109	S1109	4.0 - 8.0	3.0 - 8.0	1545.09.08	1555.09.08	
PG11	S2211	S1211	4.0 - 7.0	2.0 - 7.0	1545.11.07	1555.11.07	
PG11	S2111	S1111	5.1 - 10.0	4.0 - 10.0	1545.11.10	1555.11.10	
PG13	S2213	S1213	8.7 - 9.0	3.0 - 7.0	1545.13.07	1555.13.07	
PG13	S2113	S1113	6.0 - 12.0	5.5 - 12.0	1545.13.12	1555.13.12	
PG16	S2216	S1216	10.7 - 12.2	5.0 - 11.0	1545.16.11	1555.16.11	
PG16	S2116	S1116	10.0 - 14.0	8.5 - 14.0	1545.16.14	1555.16.14	
PG21	S2221	S1221	12.2 - 15.7	6.5 - 14.0	1545.21.14	1555.21.14	
PG21	S2121	S1121	13.8 - 18.0	11.0 - 18.0	1545.21.18	1555.21.18	
PG29	S2229	S1229	13.0 - 20.0	17.0 - 25.0	1545.29.25	1555.29.25	
PG29	S2129	S1129	18.0 - 25.0	17.0 - 25.0	1545.29.25	1555.29.25	
PG36	S2236	S1236	20.0 - 26.0	22.0 - 33.0	1545.36.33	1555.36.33	
PG36	S2136	S1136	22.0 - 32.0	22.0 - 33.0	1545.36.33	1555.36.33	
PG42	S2242	S1242	25.0 - 31.0	28.0 - 38.0	1545.42.38	1555.42.38	
PG42	S2142	S1142	32.0 - 38.0	28.0 - 38.0	1545.42.38	1555.42.38	
PG48	S2248	S1248	29.0 - 35.0	32.0 - 44.0	1545.48.44	1555.48.44	
PG48	S2148	S1148	37.0 - 44.0	32.0 - 44.0	1545.48.44	1555.48.44	

OLFLEX - NPT THREAD TYPE				AGRO - NPT THREAD TYPE			
THREAD TYPE	OLFLEX BLACK	OLFLEX GREY	DIAMETER RANGE (MM)	DIAMETER RANGE (MM)	AGRO BLACK	AGRO GREY	
NPT 3/8	S2238	S1238	2.0 - 6.0	3.0 - 8.0	1545.N0375.08	1555.N0375.08	
NPT 3/8	S2138	S1138	4.0 - 8.0	3.0 - 8.0	1545.N0375.08	1555.N0375.08	
NPT 1/2	S2212	S1212	8.7 - 9.0	3.0 - 7.0	1545.N0500.07	1555.N0500.07	
NPT 1/2	S2112	S1112	6.0 - 12.0	5.5 - 12.0	1545.N0500.12	1555.N0500.12	
NPT 3/4	S2234	S1234	12.2 - 15.7	6.5 - 14.0	1545.N0750.14	1555.N0750.14	
NPT 3/4	S2134	S1134	13.8 - 18.0	11.0 - 18.0	1545.N0750.18	1555.N0750.18	
NPT 1	S2201	S1201	14.0 - 21.0	17.0 - 22.0	1545.N1000.22	1555.N1000.22	
NPT 1	S2101	S1101	18.0 - 26.0	17.0 - 22.0	1545.N1000.22	1555.N1000.22	

OLFLEX - STRAIN RELIEF				AGRO - STRAIN RELIEF			
THREAD TYPE	OLFLEX BLACK	OLFLEX GREY	DIAMETER RANGE (MM)	DIAMETER RANGE (MM)	AGRO BLACK	AGRO GREY	
PG7	S2407	S1407	2.0 - 5.0	2.5 - 6.5	1576.07.06	1546.07.06	
PG7	S2307	S1307	3.0 - 6.5	2.5 - 6.5	1576.07.06	1546.07.06	
PG9	S2409	S1409	2.0 - 6.0	3.0 - 8.0	1576.09.08	1546.09.08	
PG9	S2309	S1309	4.0 - 8.0	3.0 - 8.0	1576.09.08	1546.09.08	
PG11	S2411	S1411	4.0 - 7.0	2.0 - 7.0	1576.11.07	1546.11.07	
PG11	S2311	S1311	5.1 - 10.0	4.0 - 10.0	1576.11.10	1546.11.10	
PG13	S2413	S1413	8.7 - 9.0	3.0 - 7.0	1576.13.07	1546.13.07	
PG13	S2313	S1313	6.0 - 12.0	5.5 - 12.0	1576.13.12	1546.13.12	
PG16	S2416	S1416	10.7 - 12.2	5.0 - 11.0	1576.16.11	1546.16.11	
PG16	S2316	S1316	10.0 - 14.0	8.5 - 14.0	1576.16.14	1546.16.14	



## PRINTED CIRCUIT BOARDS

AEI OFFERS SINGLE AND DUAL LEVEL TERMINAL BLOCKS FOR PRINTED CIRCUIT BOARDS ON 3.5MM, 5.0MM, 5.08MM, 7.5MM AND 7.62MM IN MODULAR 2 OR 3 POLE DESIGNS. CONNECTORS ARE OFFERED FROM 3.50MM, 3.81MM, 5.00MM AND 5.08MM VERSIONS IN 90° AND 180° CONFIGURATION UP TO 24 POLES.

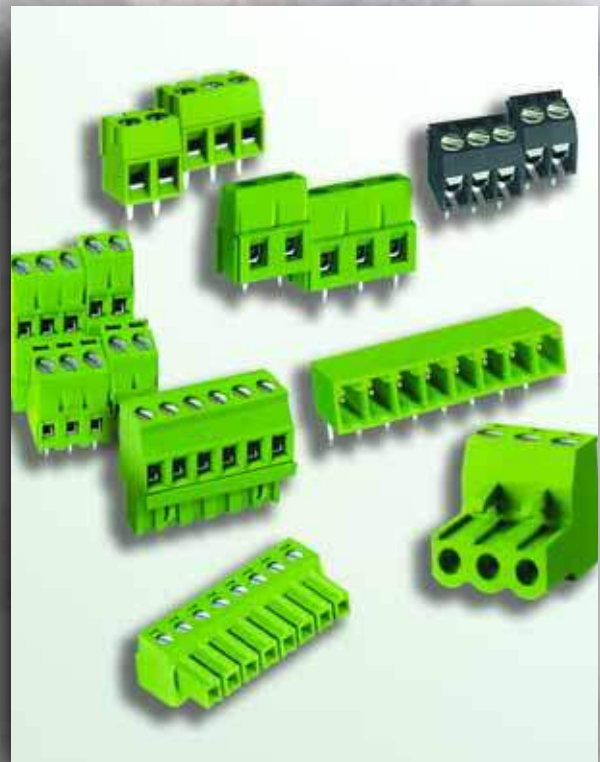



# PRINTED CIRCUIT BOARD

## TERMINAL BLOCKS

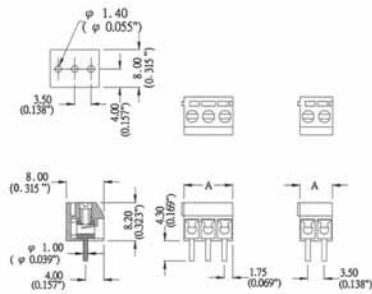

### SINGLE LEVEL • 90° • PITCH: 3.50 MM

#### TECHNICAL

TERMINAL:	BRASS, TIN PLATED
WIRE PROTECTOR:	STAINLESS STRIP STEEL
INSULATING BODY:	POLYESTER
SCREW:	M2.0, STEEL, CHROMATIZED
COLOR:	BLACK
OPERATION TEMPERATURE:	-33°C TO +105°C
SHORT-TIME TEMPERATURE:	UP TO 200°C (+392°F)
CURRENT RATING:	6 AMP AC300V
INSULATION WITHSTANDING VOLT:	AC1500V MIN
INSULATION RESISTANCE:	>5000Ω AT DC500V
PCB HOLE DIAMETER:	φ 1.4 MM
WIRE STRIP LENGTH:	4MM - 5MM
WIRE RANGE:	16 - 26 AWG
SCREWS TORQUE:	2.5 LB-INCH

ITEM No.	POLES	A (MM)	A (INCH)
<b>T-212-350M2</b>	2	7.00	0.276
<b>T-212-350M3</b>	3	10.50	0.413

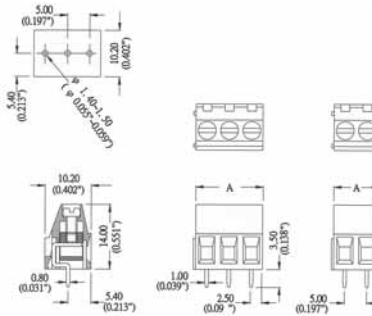

### SINGLE LEVEL • 90° • PITCH: 5.00 MM

#### TECHNICAL

CAGE CLAMP:	BRASS, NI PLATED
TERMINAL:	BRASS, TIN PLATED, 0.8T
INSULATING BODY:	POLYAMIDE66 (UL94V-O)
SCREW:	M2.6, STEEL, NI PLATED
COLOR:	GREEN
OPERATION TEMPERATURE:	-55°C TO +105°C
SHORT-TIME TEMPERATURE:	UP TO 250°C (+482°F)
CURRENT RATING:	16 AMP AC300V
INSULATION WITHSTANDING VOLT:	AC2000V MIN
INSULATION RESISTANCE:	>5000Ω AT DC500V
PCB HOLE DIAMETER:	φ 1.4 MM - φ 1.5 MM
WIRE STRIP LENGTH:	4MM - 5MM
WIRE RANGE:	14 - 24 AWG
SCREWS TORQUE:	5.0 LB-INCH

ITEM No.	POLES	A (MM)	A (INCH)
<b>T-312-500M2</b>	2	10.00	0.394
<b>T-312-500M3</b>	3	15.00	0.591

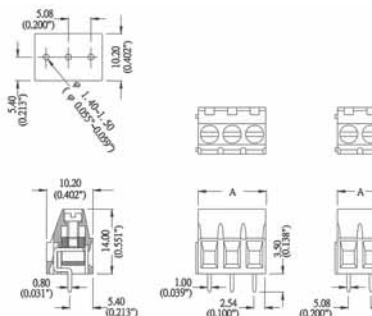

### SINGLE LEVEL • 90° • PITCH: 5.08 MM

#### TECHNICAL

TERMINAL:	BRASS, NI PLATED
WIRE PROTECTOR:	BRASS, TIN PLATED, 0.8T
INSULATING BODY:	POLYAMIDE66 (UL94V-O)
SCREW:	M2.6, STEEL, NI PLATED
COLOR:	GREEN
OPERATION TEMPERATURE:	-55°C TO +105°C
SHORT-TIME TEMPERATURE:	UP TO 250°C (+482°F)
CURRENT RATING:	16 AMP AC300V
INSULATION WITHSTANDING VOLT:	AC2000V MIN
INSULATION RESISTANCE:	>5000Ω AT DC500V
PCB HOLE DIAMETER:	φ 1.4 MM - φ 1.5 MM
WIRE STRIP LENGTH:	4MM - 5MM
WIRE RANGE:	14 - 24 AWG
SCREWS TORQUE:	5.0 LB-INCH

ITEM No.	POLES	A (MM)	A (INCH)
<b>T-312-508M2</b>	2	10.16	0.400
<b>T-312-508M3</b>	3	15.24	0.600



## PRINTED CIRCUIT BOARD

### TERMINAL BLOCKS

#### SINGLE LEVEL • 90° • PITCH: 7.50 MM

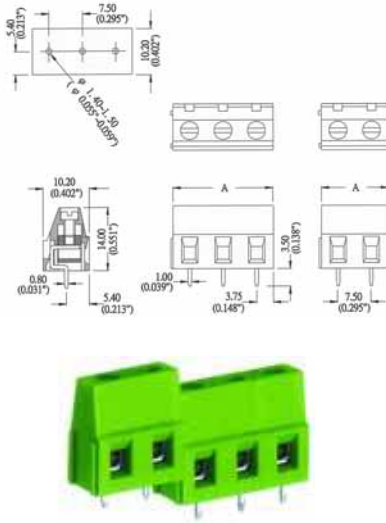

##### TECHNICAL

CAGE CLAMP:	BRASS, NI PLATED
TERMINAL:	BRASS, TIN PLATED, 0.8T
INSULATING BODY:	POLYAMIDE66 (UL94V-0)
SCREW:	M2.6, STEEL, NI PLATED
COLOR:	GREEN
OPERATION TEMPERATURE:	-55°C TO +105°C
SHORT-TIME TEMPERATURE:	UP TO 250°C (+482°F)
CURRENT RATING:	16 AMP AC300V
INSULATION WITHSTANDING VOLT:	AC2000V MIN
INSULATION RESISTANCE:	>5000Ω AT DC500V
PCB HOLE DIAMETER:	φ 1.4 MM - φ 1.5 MM
WIRE STRIP LENGTH:	4MM - 5MM
WIRE RANGE:	14 - 24 AWG
SCREWS TORQUE:	5.0 LB-INCH

ITEM NO.	POLES	A (MM)	A (INCH)
T-312-750M2	2	15.00	0.591
T-312-750M3	3	22.50	0.886

#### SINGLE LEVEL • 90° • PITCH: 7.62 MM

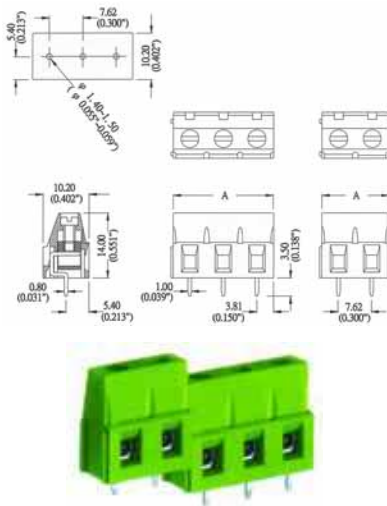

##### TECHNICAL

CAGE CLAMP:	BRASS, NI PLATED
TERMINAL:	BRASS, TIN PLATED, 0.8T
INSULATING BODY:	POLYAMIDE66 (UL94V-0)
SCREW:	M2.6, STEEL, NI PLATED
COLOR:	GREEN
OPERATION TEMPERATURE:	-55°C TO +105°C
SHORT-TIME TEMPERATURE:	UP TO 250°C (+482°F)
CURRENT RATING:	16 AMP AC300V
INSULATION WITHSTANDING VOLT:	AC2000V MIN
INSULATION RESISTANCE:	>5000Ω AT DC500V
PCB HOLE DIAMETER:	φ 1.4 MM - φ 1.5 MM
WIRE STRIP LENGTH:	4MM - 5MM
WIRE RANGE:	14 - 24 AWG
SCREWS TORQUE:	5.0 LB-INCH

ITEM NO.	POLES	A (MM)	A (INCH)
T-312-762M2	2	15.24	0.600
T-312-762M3	3	22.86	0.900

#### SINGLE LEVEL • 90° • PITCH: 3.81 MM

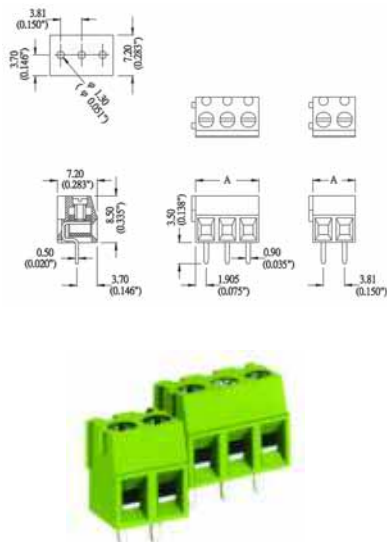

##### TECHNICAL

CAGE CLAMP:	BRASS, NI PLATED
TERMINAL:	BRASS, TIN PLATED, 0.5T
INSULATING BODY:	POLYAMIDE66 (UL94V-0)
SCREW:	M2.0, STEEL, NI PLATED
COLOR:	GREEN
OPERATION TEMPERATURE:	-55°C TO +105°C
SHORT-TIME TEMPERATURE:	UP TO 200°C (+392°F)
CURRENT RATING:	8 AMP AC300V
INSULATION WITHSTANDING VOLT:	AC2000V MIN
INSULATION RESISTANCE:	>5000Ω AT DC500V
PCB HOLE DIAMETER:	φ 1.3
WIRE STRIP LENGTH:	4MM - 5MM
WIRE RANGE:	16 - 26 AWG
SCREWS TORQUE:	2.5 LB-INCH

ITEM NO.	POLES	A (MM)	A (INCH)
T-332-381M2	2	7.62	0.300
T-332-381M3	3	11.43	0.450

# PRINTED CIRCUIT BOARD

## TERMINAL BLOCKS

### DOUBLE LEVEL • 90° • PITCH: 5.00 MM

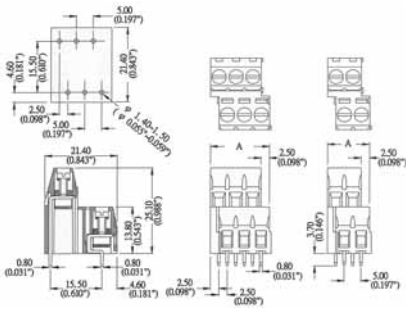

#### TECHNICAL

CAGE CLAMP:	BRASS, NI PLATED
TERMINAL:	BRASS, TIN PLATED, 0.8T
INSULATING BODY:	POLYAMIDE66 (UL94V-O)
SCREW:	M2.6, STEEL, NI PLATED
COLOR:	GREEN
OPERATION TEMPERATURE:	-55°C TO +105°C
SHORT-TIME TEMPERATURE:	UP TO 250°C (+482°F)
CURRENT RATING:	16 AMP AC300V
INSULATION WITHSTANDING VOLT:	AC2000V MIN
INSULATION RESISTANCE:	>5000Ω AT DC500V
PCB HOLE DIAMETER:	φ 1.4 MM - φ 1.5 MM
WIRE STRIP LENGTH:	4MM - 5MM
WIRE RANGE:	14 - 24 AWG
SCREWS TORQUE:	4.5 LB-INCH

ITEM NO.	POLES	A (MM)	A (INCH)
T-362-500M2	2	12.50	0.492
T-362-500M3	3	17.50	0.689

### DOUBLE LEVEL • 90° • PITCH: 5.08 MM

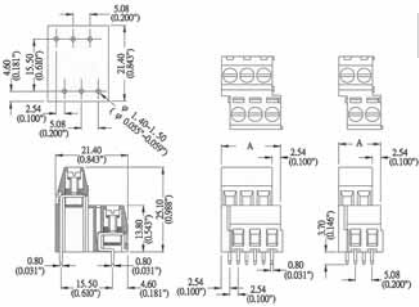

#### TECHNICAL

CAGE CLAMP:	BRASS, NI PLATED
TERMINAL:	BRASS, TIN PLATED, 0.8T
INSULATING BODY:	POLYAMIDE66 (UL94V-O)
SCREW:	M2.6, STEEL, NI PLATED
COLOR:	GREEN
OPERATION TEMPERATURE:	-55°C TO +105°C
SHORT-TIME TEMPERATURE:	UP TO 250°C (+482°F)
CURRENT RATING:	16 AMP AC300V
INSULATION WITHSTANDING VOLT:	AC2000V MIN
INSULATION RESISTANCE:	>5000Ω AT DC500V
PCB HOLE DIAMETER:	φ 1.4 MM - φ 1.5 MM
WIRE STRIP LENGTH:	4MM - 5MM
WIRE RANGE:	14 - 24 AWG
SCREWS TORQUE:	4.5 LB-INCH

ITEM NO.	POLES	A (MM)	A (INCH)
T-362-508M2	2	12.70	0.500
T-362-508M3	3	17.78	0.700



# PRINTED CIRCUIT BOARD

## PLUGS

### PLUGS • 180°

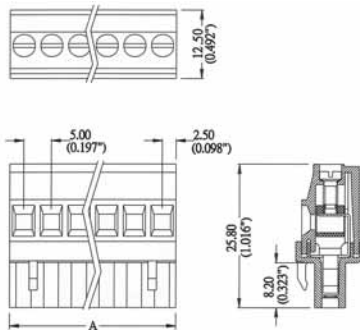
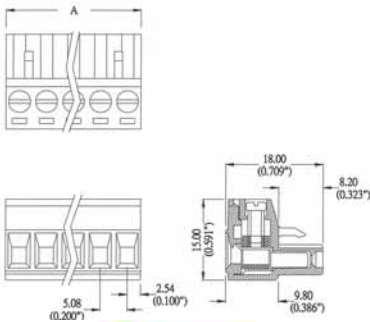
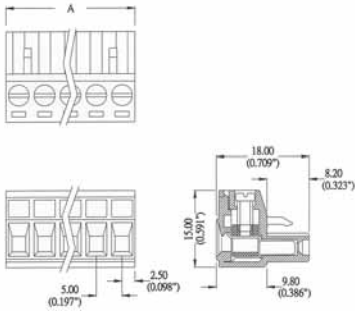

#### TECHNICAL

CAGE CLAMP:	BRASS, NI PLATED
CONTACT:	PHOSPHOR BRONZE, TIN PLATED, 0.4T
INSULATING BODY:	POLYAMIDE66 (UL94V-0)
SCREW:	M3.0, STEEL, ZINC PLATED
COLOR:	GREEN
OPERATION TEMPERATURE:	-55°C TO +105°C
SHORT-TIME TEMPERATURE:	UP TO 250°C (+482°F)
CURRENT RATING:	16 AMP AC300V
INSULATION WITHSTANDING VOLT:	AC2000V MIN
INSULATION RESISTANCE:	>5000Ω AT DC500V
WIRE STRIP LENGTH:	4 MM - 5 MM
WIRE RANGE:	14 - 24 AWG
SCREWS TORQUE:	4.5 LB-INCH

#### PITCH: 5.00 MM

ITEM No.	POLES	A (MM)	A (INCH)	ITEM No.	POLES	A (MM)	A (INCH)
P-100-50002	2	10.00	0.394	P-100-50009	9	45.00	1.772
P-100-50003	3	15.00	0.591	P-100-50010	10	50.00	1.969
P-100-50004	4	20.00	0.787	P-100-50011	11	55.00	2.165
P-100-50005	5	25.00	0.984	P-100-50012	12	60.00	2.362
P-100-50006	6	30.00	1.181				
P-100-50007	7	35.00	1.378	P-100-50024	24	120.00	4.724
P-100-50008	8	40.00	1.575				

#### PITCH: 5.08 MM

ITEM No.	POLES	A (MM)	A (INCH)	ITEM No.	POLES	A (MM)	A (INCH)
P-100-50802	2	10.16	0.400	P-100-50809	9	45.72	1.800
P-100-50803	3	15.24	0.600	P-100-50810	10	50.80	2.000
P-100-50804	4	20.32	0.800	P-100-50811	11	55.88	2.200
P-100-50805	5	25.40	1.000	P-100-50812	12	60.96	2.400
P-100-50806	6	30.48	1.200				
P-100-50807	7	35.56	1.400	P-100-50824	24	121.92	4.800
P-100-50808	8	40.64	1.600				

### PLUGS • 90° • PITCH: 5.00 MM

#### TECHNICAL

CAGE CLAMP:	BRASS, NI PLATED
CONTACT:	PHOSPHOR BRONZE, TIN PLATED, 0.4T
INSULATING BODY:	POLYAMIDE66 (UL94V-0)
SCREW:	M2.6, STEEL, ZINC PLATED
COLOR:	GREEN
OPERATION TEMPERATURE:	-55°C TO +105°C
SHORT-TIME TEMPERATURE:	UP TO 250°C (+482°F)
CURRENT RATING:	16 AMP AC300V
INSULATION WITHSTANDING VOLT:	AC2000V MIN
INSULATION RESISTANCE:	>5000Ω AT DC500V
WIRE STRIP LENGTH:	7 MM
WIRE RANGE:	14 - 24 AWG
SCREWS TORQUE:	4.5 LB-INCH

ITEM No.	POLES	A (MM)	A (INCH)	ITEM No.	POLES	A (MM)	A (INCH)
P-200-50002	2	10.00	0.394	P-200-50009	9	45.00	1.772
P-200-50003	3	15.00	0.591	P-200-50010	10	50.00	1.969
P-200-50004	4	20.00	0.787	P-200-50011	11	55.00	2.165
P-200-50005	5	25.00	0.984	P-200-50012	12	60.00	2.362
P-200-50006	6	30.00	1.181				
P-200-50007	7	35.00	1.378	P-200-50024	24	120.00	4.724
P-200-50008	8	40.00	1.575				

# PRINTED CIRCUIT BOARD

## PLUGS

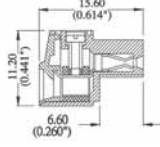
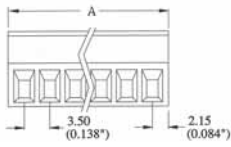
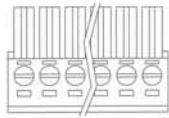

### PLUGS • 180° • PITCH: 3.50 MM

#### TECHNICAL

CAGE CLAMP:	BRASS, NI PLATED
CONTACT:	PHOSPHOR BRONZE, TIN PLATED, 0.3T
INSULATING BODY:	POLYAMIDE66 (UL94V-0)
SCREW:	M2.0, STEEL, ZINC
COLOR:	GREEN
OPERATION TEMPERATURE:	-55°C TO +105°C
SHORT-TIME TEMPERATURE:	UP TO 250°C (+482°F)
CURRENT RATING:	10 AMP AC300V
INSULATION WITHSTANDING VOLT:	AC2000V MIN
INSULATION RESISTANCE:	>5000Ω AT DC500V
WIRE STRIP LENGTH:	6.5 MM
WIRE RANGE:	16 - 26 AWG
SCREWS TORQUE:	2.5 LB-INCH

ITEM No.	POLES	A (MM)	A (INCH)	ITEM No.	POLES	A (MM)	A (INCH)
P-420-35002	2	7.80	0.307	P-420-35009	9	32.30	1.272
P-420-35003	3	11.30	0.445	P-420-35010	10	35.80	1.409
P-420-35004	4	14.80	0.583	P-420-35011	11	39.30	1.547
P-420-35005	5	18.30	0.720	P-420-35012	12	42.80	1.685
P-420-35006	6	21.80	0.858	P-420-35013	13	46.30	1.823
P-420-35007	7	25.30	0.996	P-420-35014	14	49.80	1.961
P-420-35008	8	28.80	1.134				

### PLUGS • 180° • PITCH: 3.81 MM

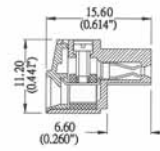
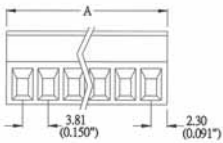
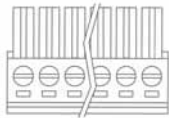

#### TECHNICAL

CAGE CLAMP:	BRASS, NI PLATED
CONTACT:	PHOSPHOR BRONZE, TIN PLATED, 0.3T
INSULATING BODY:	POLYAMIDE66 (UL94V-0)
SCREW:	M2.0, STEEL, ZINC
COLOR:	GREEN
OPERATION TEMPERATURE:	-55°C TO +105°C
SHORT-TIME TEMPERATURE:	UP TO 250°C (+482°F)
CURRENT RATING:	10 AMP AC300V
INSULATION WITHSTANDING VOLT:	AC2000V MIN
INSULATION RESISTANCE:	>5000Ω AT DC500V
WIRE STRIP LENGTH:	6.5 MM
WIRE RANGE:	16 - 26 AWG
SCREWS TORQUE:	2.5 LB-INCH

ITEM No.	POLES	A (MM)	A (INCH)	ITEM No.	POLES	A (MM)	A (INCH)
P-420-38102	2	8.41	0.331	P-420-38109	9	35.08	1.381
P-420-38103	3	12.22	0.481	P-420-38110	10	38.89	1.531
P-420-38104	4	16.03	0.631	P-420-38111	11	42.70	1.681
P-420-38105	5	19.84	0.781	P-420-38112	12	46.51	1.831
P-420-38106	6	23.65	0.931				
P-420-38107	7	27.46	1.081	P-420-38116	16	61.75	2.431
P-420-38108	8	31.27	1.231				



## PRINTED CIRCUIT BOARD

### HEADERS

HEADERS • CLOSED 90° • PITCH: 3.50 MM

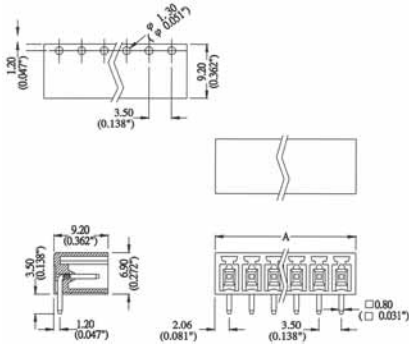

#### TECHNICAL

SOLDER PIN:	0.8 MM, BRASS, TIN PLATED
INSULATING BODY:	POLYAMIDE66 (UL94V-0)
COLOR:	GREEN
OPERATION TEMPERATURE:	-55°C TO +105°C
SHORT-TIME TEMPERATURE:	UP TO 250°C (+482°F)
CURRENT RATING:	12 AMP AC300V
INSULATION WITHSTANDING VOLT:	AC2000V MIN
INSULATION RESISTANCE:	>5000Ω AT DC500V
PDB HOLE DIAMETER:	φ 1.3 MM

ITEM NO.	POLES	A (MM)	A (INCH)	ITEM NO.	POLES	A (MM)	A (INCH)
H-030-35002	2	7.60	0.299	H-030-35009	9	32.10	1.264
H-030-35003	3	11.10	0.437	H-030-35010	10	35.60	1.402
H-030-35004	4	14.60	0.575	H-030-35011	11	39.10	1.539
H-030-35005	5	18.10	0.713	H-030-35012	12	42.60	1.677
H-030-35006	6	21.60	0.850	H-030-35013	13	46.10	1.815
H-030-35007	7	25.10	0.988	H-030-35014	14	49.60	1.953
H-030-35008	8	28.60	1.126				

HEADERS • CLOSED 90° • PITCH: 3.81 MM

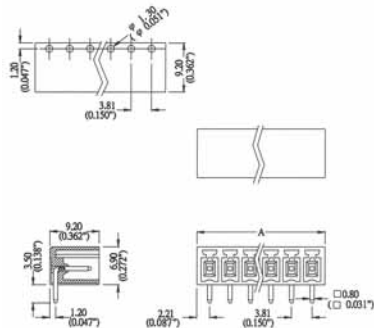

#### TECHNICAL

SOLDER PIN:	0.8 MM, BRASS, TIN PLATED
INSULATING BODY:	POLYAMIDE66 (UL94V-0)
COLOR:	GREEN
OPERATION TEMPERATURE:	-55°C TO +105°C
SHORT-TIME TEMPERATURE:	UP TO 250°C (+482°F)
CURRENT RATING:	12 AMP AC300V
INSULATION WITHSTANDING VOLT:	AC2000V MIN
INSULATION RESISTANCE:	>5000Ω AT DC500V
PDB HOLE DIAMETER:	φ 1.3 MM

ITEM NO.	POLES	A (MM)	A (INCH)	ITEM NO.	POLES	A (MM)	A (INCH)
H-030-38102	2	8.23	0.324	H-030-38109	9	34.90	1.374
H-030-38103	3	12.04	0.474	H-030-38110	10	38.71	1.524
H-030-38104	4	15.85	0.624	H-030-38111	11	42.52	1.674
H-030-38105	5	19.66	0.774	H-030-38112	12	46.33	1.824
H-030-38106	6	23.47	0.924				
H-030-38107	7	27.28	1.074	H-030-38116	16	61.57	2.424
H-030-38108	8	31.09	1.224				

# PRINTED CIRCUIT BOARD

## HEADERS

HEADERS • CLOSED 90° • PITCH: 5.00 MM

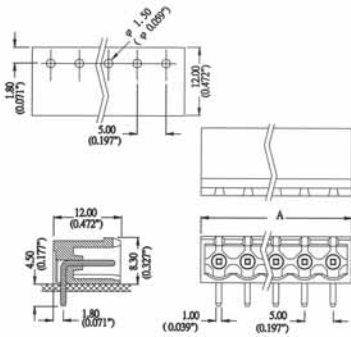

### TECHNICAL

SOLDER PIN:	1.0 MM, BRASS, TIN PLATED
INSULATING BODY:	POLYAMIDE66 (UL94V-0)
COLOR:	GREEN
OPERATION TEMPERATURE:	-55°C TO +105°C
SHORT-TIME TEMPERATURE:	UP TO 250°C (+482°F)
CURRENT RATING:	12 AMP AC300V
INSULATION WITHSTANDING VOLT:	AC2000V MIN
INSULATION RESISTANCE:	>5000Ω AT DC500V
PDB HOLE DIAMETER:	φ 1.5 MM

ITEM NO.	POLES	A (MM)	A (INCH)	ITEM NO.	POLES	A (MM)	A (INCH)
H-030-50002	2	11.60	0.457	H-030-50009	9	46.60	1.835
H-030-50003	3	16.60	0.654	H-030-50010	10	51.60	2.031
H-030-50004	4	21.60	0.850	H-030-50011	11	56.60	2.228
H-030-50005	5	26.60	1.047	H-030-50012	12	61.60	2.425
H-030-50006	6	31.60	1.244				
H-030-50007	7	36.60	1.441	H-030-50016	16	121.60	4.787
H-030-50008	8	41.60	1.638				

HEADERS • CLOSED 90° • PITCH: 5.08 MM

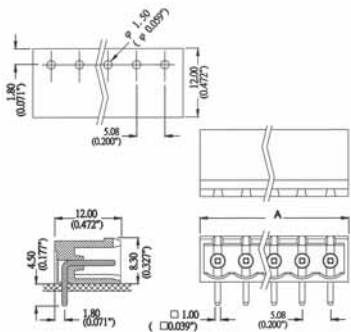

### TECHNICAL

SOLDER PIN:	1.0 MM, BRASS, TIN PLATED
INSULATING BODY:	POLYAMIDE66 (UL94V-0)
COLOR:	GREEN
OPERATION TEMPERATURE:	-55°C TO +105°C
SHORT-TIME TEMPERATURE:	UP TO 250°C (+482°F)
CURRENT RATING:	12 AMP AC300V
INSULATION WITHSTANDING VOLT:	AC2000V MIN
INSULATION RESISTANCE:	>5000Ω AT DC500V
PDB HOLE DIAMETER:	φ 1.5 MM

ITEM NO.	POLES	A (MM)	A (INCH)	ITEM NO.	POLES	A (MM)	A (INCH)
H-030-50802	2	11.76	0.463	H-030-50809	9	47.32	1.863
H-030-50803	3	16.84	0.663	H-030-50810	10	52.40	2.063
H-030-50804	4	21.92	0.863	H-030-50811	11	57.48	2.263
H-030-50805	5	27.00	1.063	H-030-50812	12	62.56	2.463
H-030-50806	6	32.08	1.263				
H-030-50807	7	37.16	1.463	H-030-50816	16	123.52	4.863
H-030-50808	8	42.24	1.663				



# PRINTED CIRCUIT BOARD

## HEADERS

### HEADERS • CLOSED 180° • PITCH: 3.50 MM

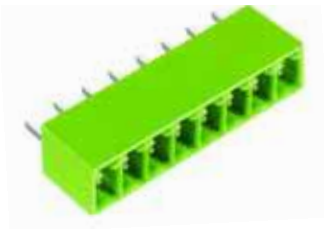
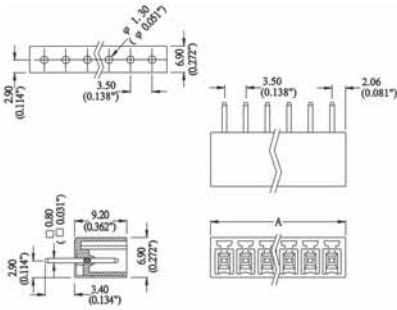

#### TECHNICAL

SOLDER PIN:	0.8 MM, BRASS, TIN PLATED
INSULATING BODY:	POLYAMIDE66 (UL94V-O)
COLOR:	GREEN
OPERATION TEMPERATURE:	-55°C TO +105°C
SHORT-TIME TEMPERATURE:	UP TO 250°C (+482°F)
CURRENT RATING:	12 AMP AC300V
INSULATION WITHSTANDING VOLT:	AC2000V MIN
INSULATION RESISTANCE:	>5000Ω AT DC500V
PDB HOLE DIAMETER:	φ 1.3 MM

ITEM No.	POLES	A (MM)	A (INCH)	ITEM No.	POLES	A (MM)	A (INCH)
H-040-35002	2	7.60	0.299	H-040-35009	9	32.10	1.264
H-040-35003	3	11.10	0.437	H-040-35010	10	35.60	1.402
H-040-35004	4	14.60	0.575	H-040-35011	11	39.10	1.539
H-040-35005	5	18.10	0.713	H-040-35012	12	42.60	1.677
H-040-35006	6	21.60	0.850	H-040-35013	13	46.10	1.815
H-040-35007	7	25.10	0.988	H-040-35014	14	49.60	1.953
H-040-35008	8	28.60	1.126				

### HEADERS • CLOSED 180° • PITCH: 3.81 MM

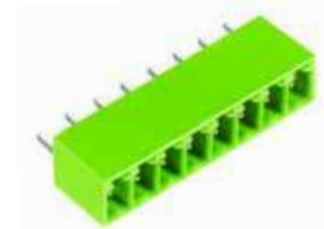
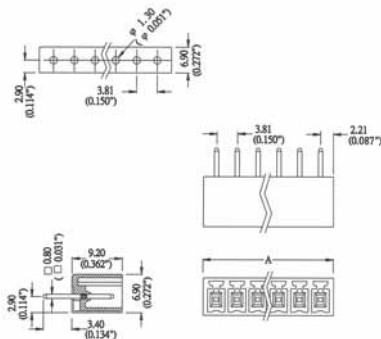

#### TECHNICAL

SOLDER PIN:	0.8 MM, BRASS, TIN PLATED
INSULATING BODY:	POLYAMIDE66 (UL94V-O)
COLOR:	GREEN
OPERATION TEMPERATURE:	-55°C TO +105°C
SHORT-TIME TEMPERATURE:	UP TO 250°C (+482°F)
CURRENT RATING:	12 AMP AC300V
INSULATION WITHSTANDING VOLT:	AC2000V MIN
INSULATION RESISTANCE:	>5000Ω AT DC500V
PDB HOLE DIAMETER:	φ 1.3 MM

ITEM No.	POLES	A (MM)	A (INCH)	ITEM No.	POLES	A (MM)	A (INCH)
H-040-38102	2	8.23	0.324	H-040-38109	9	34.90	1.374
H-040-38103	3	12.04	0.474	H-040-38110	10	38.71	1.524
H-040-38104	4	15.85	0.624	H-040-38111	11	42.52	1.674
H-040-38105	5	19.66	0.774	H-040-38112	12	46.33	1.824
H-040-38106	6	23.47	0.924				
H-040-38107	7	27.28	1.074	H-040-38116	16	61.57	2.424
H-040-38108	8	31.09	1.224				



# PRINTED CIRCUIT BOARD

## HEADERS

### HEADERS • CLOSED 180° • PITCH: 5.00 MM

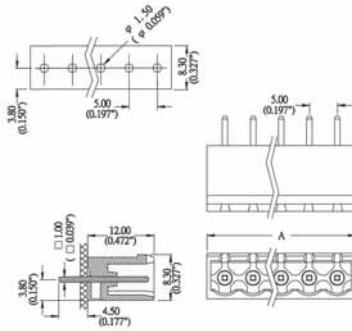

#### TECHNICAL

SOLDER PIN:	1.0 MM, BRASS, TIN PLATED
INSULATING BODY:	POLYAMIDE66 (UL94V-O)
COLOR:	GREEN
OPERATION TEMPERATURE:	-55°C TO +105°C
SHORT-TIME TEMPERATURE:	UP TO 250°C (+482°F)
CURRENT RATING:	12 AMP AC300V
INSULATION WITHSTANDING VOLT:	AC2000V MIN
INSULATION RESISTANCE:	>5000Ω AT DC500V
PDB HOLE DIAMETER:	φ 1.5 MM

ITEM NO.	POLES	A (MM)	A (INCH)	ITEM NO.	POLES	A (MM)	A (INCH)
<b>H-040-50002</b>	2	11.60	0.457	<b>H-040-50009</b>	9	46.60	1.835
<b>H-040-50003</b>	3	16.60	0.654	<b>H-040-50010</b>	10	51.60	2.031
<b>H-040-50004</b>	4	21.60	0.850	<b>H-040-50011</b>	11	56.60	2.228
<b>H-040-50005</b>	5	26.60	1.047	<b>H-040-50012</b>	12	61.60	2.425
<b>H-040-50006</b>	6	31.60	1.244				
<b>H-040-50007</b>	7	36.60	1.441	<b>H-040-50016</b>	16	121.60	4.787
<b>H-040-50008</b>	8	41.60	1.638				

### HEADERS • CLOSED 180° • PITCH: 5.08 MM

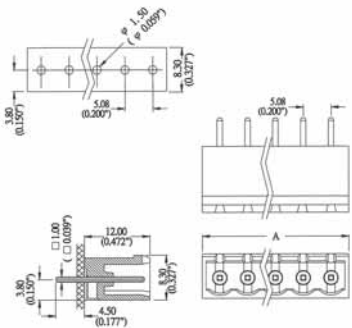

#### TECHNICAL

SOLDER PIN:	1.0 MM, BRASS, TIN PLATED
INSULATING BODY:	POLYAMIDE66 (UL94V-O)
COLOR:	GREEN
OPERATION TEMPERATURE:	-55°C TO +105°C
SHORT-TIME TEMPERATURE:	UP TO 250°C (+482°F)
CURRENT RATING:	12 AMP AC300V
INSULATION WITHSTANDING VOLT:	AC2000V MIN
INSULATION RESISTANCE:	>5000Ω AT DC500V
PDB HOLE DIAMETER:	φ 1.5 MM

ITEM NO.	POLES	A (MM)	A (INCH)	ITEM NO.	POLES	A (MM)	A (INCH)
<b>H-040-50802</b>	2	11.76	0.463	<b>H-040-50809</b>	9	47.32	1.863
<b>H-040-50803</b>	3	16.84	0.663	<b>H-040-50810</b>	10	52.40	2.063
<b>H-040-50804</b>	4	21.92	0.863	<b>H-040-50811</b>	11	57.48	2.263
<b>H-040-50805</b>	5	27.00	1.063	<b>H-040-50812</b>	12	62.56	2.463
<b>H-040-50806</b>	6	32.08	1.263				
<b>H-040-50807</b>	7	37.16	1.463	<b>H-040-50816</b>	16	123.52	4.863
<b>H-040-50808</b>	8	42.24	1.663				



## SCREWDRIVERS

THE ERGONOMIC DESIGN OF OUR SCREWDRIVER HANDLES EFFICIENTLY PROVIDES THE PROPER TIGHTENING TORQUE FOR YOUR TERMINAL BLOCK APPLICATION. INSULATION IS RATED AT 10,000V FOR YOUR SAFETY. THE TIPS OF OUR SCREWDRIVERS ARE MADE OF HARDENED STEEL FOR A LONGER TOOL LIFE.



## SCREWDRIVERS FOR TERMINAL BLOCKS

### FEATURES

- ERGONOMIC HANDLE PROVIDES PROPER TIGHTENING TORQUE
- IMPACT RESISTANT MATERIAL USED TO PROVIDE LONG LASTING USE
- INSULATION SLEEVE PROVIDES ISOLATION UP TO 10,000 V
- APPROVALS: DIN - VDE 0680/2, ISO, IEC 900, EN 60900

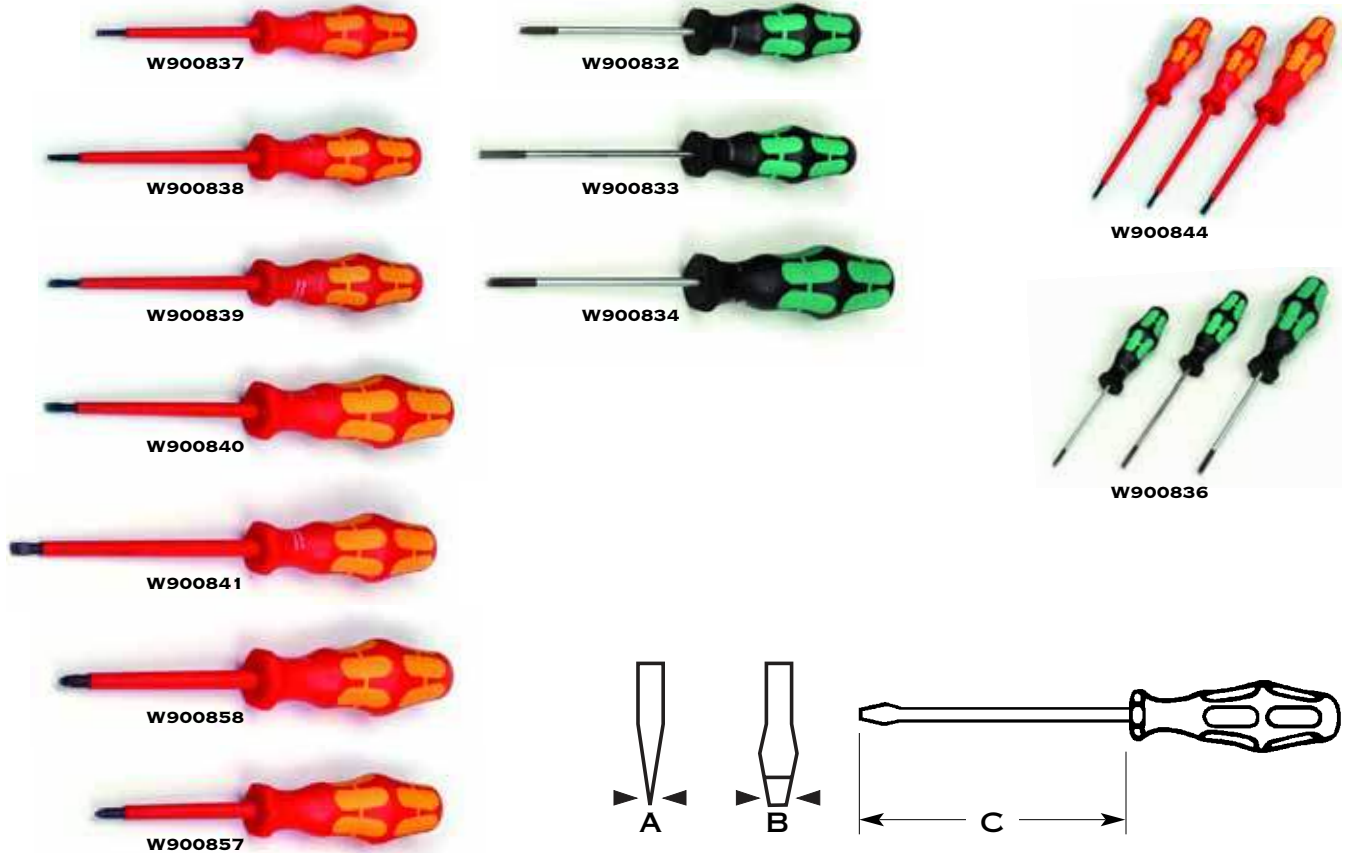

DESCRIPTION	PART NO.	A (MM)	B (MM)	C (MM)
INSULATED SCREWDRIVERS	W900837	0.4	2.5	80
	W900838	0.5	3.0	100
	W900839	0.6	3.5	100
	W900840	0.8	4.0	100
	W900841	1.0	5.5	125
KIT FOR INSULATED SCREWDRIVERS (3)	W900844 (INCLUDES ONE OF EACH: W900838, W900839, W900840)			
NON-INSULATED SCREWDRIVERS	W900832	0.5	3.0	80
	W900833	0.6	3.5	100
	W900834	0.8	4.0	100
KIT FOR NON-INSULATED SCREWDRIVERS (3)	W900836 (INCLUDES ONE OF EACH: W900832, W900833, W900834)			
INSULATED PHILLIPS SCREWDRIVER	W900858 (100 MM)			
NON-INSULATED PHILLIPS SCREWDRIVER	W900857 (80 MM)			



# INDEX

PART #	PAGE #	PART #	PAGE #	PART #	PAGE #	PART #	PAGE #	PART #	PAGE #
8000.06	.90	8840	.93	336100	.22	450210	.33	476249	.18
8000.08	.90	8848.48	.93	336220	.20	463110	.13	476252	.18
8000.1	.90	8850	.93	336230	.20	463150	.13	476253	.18
8000.12	.90	8863	.93	336240	.20	463170	.13	476254	.18
8000.17	.90	16140	.44	336250	.20	467910	.13	480132	.26
8000.2	.90	16240	.44	351100	.28	467919	.9	480133	.26
8000.25	.90	16340	.44	351120	.31	467950	.13	480134	.26
8000.32	.90	19414	.79	351220	.28	474122	.9	480139	.26
8000.4	.90	19418	.80	351310	.28	474123	.9	480172	.32
8000.5	.90	19419	.79	351320	.28	474124	.9	480173	.32
8000.63	.90	19420	.80	351510	.28	474129	.9	480174	.32
8000.75	.90	19421	.79	351720	.31	474132	.9	480179	.32
8007	.90	19422	.80	351750	.31	474132	.24	480182	.32
8009	.90	19423	.79	353100	.27	474133	.9	480183	.32
8011	.90	19429	.80	353200	.33	474133	.24	480184	.32
8013	.90	19440	.79	353300	.33	474134	.9	480189	.32
8016	.90	101050	.40	354100	.28	474134	.24	485204	.13
8021	.90	101075	.40	355110	.30	474139	.9	485206	.13
8029	.90	101100	.40	355120	.30	474139	.24	485210	.13
8036	.90	101150	.40	355720	.30	474142	.10	485216	.13
8042	.90	101250	.40	355750	.30	474143	.10	485235	.13
8048	.90	102050	.40	360110	.27	474144	.10	485506	.32
8207	.91	102075	.40	370500	.32	474149	.10	485510	.32
8209	.91	102100	.40	370501	.32	474152	.10	490020	.13
8211	.91	102150	.40	370502	.32	474153	.10	490040	.9
8212	.91	102250	.40	370590	.32	474154	.10	490070	.9
8213	.91	103050	.40	370591	.32	474159	.10	490080	.10
8216	.91	103075	.40	370592	.32	474162	.10	492010	.9
8217	.91	103100	.40	375500	.32	474163	.10	492020	.10
8220	.91	103150	.40	375501	.32	474164	.10	493020	.9
8221	.91	103250	.40	375502	.32	474169	.10	493023	.9
8225	.91	161025	.44	375590	.32	474172	.10	493040	.9
8229	.91	161040	.44	375591	.32	474173	.10	495040	.13
8232	.91	161050	.44	375592	.32	474174	.10	496110	.13
8236	.91	162025	.44	420020	.34	474179	.10	496119	.9
8240	.91	162050	.44	420120	.34	475112	.13	496250	.9
8242	.91	163025	.44	421020	.34	475113	.13	496260	.13
8248.48	.91	163050	.44	421120	.34	475114	.13	498110	.13
8250	.91	304120	.9	430022	.34	475119	.13	498120	.13
8263	.91	304130	.9	430032	.34	475122	.13	498130	.9
8706.08	.92	304140	.10	430042	.34	475123	.13	498130	.13
8707.08	.92	304150	.10	432012	.34	475124	.13	498140	.9
8708.08	.92	304160	.10	432022	.34	475129	.13	498140	.13
8709.08	.92	304170	.10	432032	.34	475132	.13	505000	.35
8710.08	.92	304190	.10	432042	.34	475132	.13	505001	.35
8711.08	.92	305110	.13	444120	.9	475133	.13	505002	.35
8712.08	.92	305120	.13	444160	.10	475134	.13	505003	.35
8713.08	.92	305130	.13	445110	.13	475139	.13	505004	.35
8716.08	.92	305140	.13	445150	.13	475142	.13	505005	.35
8717.08	.92	305150	.13	445170	.13	475143	.13	505006	.35
8720.08	.92	305160	.13	446210	.21	475144	.13	505007	.35
8721.08	.92	305170	.13	446219	.21	475149	.13	505008	.35
8725.08	.92	305190	.13	446260	.23	475152	.13	505009	.35
8729.08	.92	306220	.18	446270	.22	475153	.13	505010	.35
8732.08	.92	306230	.18	446272	.22	475154	.13	505020	.35
8736.08	.92	306240	.18	446279	.22	475159	.13	505021	.35
8740.08	.92	306250	.18	446320	.18	475162	.13	505022	.35
8742.08	.92	318100	.23	446322	.20	475163	.13	505023	.35
8748.08	.92	318120	.23	446330	.18	475164	.13	505024	.35
8750.08	.92	319100	.24	446332	.20	475169	.13	505030	.35
8763.08	.92	319120	.24	446340	.18	475172	.13	505040	.35
8775.08	.92	324100	.26	446342	.20	475173	.13	505041	.35
8807	.93	324200	.26	446349	.18	475174	.13	505042	.35
8809	.93	324300	.26	446350	.18	475179	.13	505043	.35
8811	.93	326050	.21	446352	.20	476222	.18	505044	.35
8812	.93	326100	.22	449010	.24	476223	.18	505045	.35
8813	.93	326200	.22	450040	.27	476224	.18	505046	.35
8816	.93	326210	.22	450050	.27	476229	.18	505047	.35
8817	.93	331120	.16	450060	.30	476232	.18	505048	.35
8820	.93	331130	.16	450100	.32	476233	.18	505049	.35
8821	.93	331140	.16	450109	.32	476234	.18	505050	.35
8825	.93	331150	.16	450130	.26	476239	.18	505051	.35
8829	.93	334120	.12	450140	.26	476242	.18	505052	.35
8832	.93	334140	.12	450150	.26	476243	.18	505053	.35
8836	.93	334160	.12	450200	.33	476244	.18	505054	.35

# INDEX

PART #	PAGE #	PART #	PAGE #	PART #	PAGE #	PART #	PAGE #	PART #	PAGE #
505055	.35	515016	.36	516046	.36	518025	.36	1162010	.38
505056	.35	515017	.36	516047	.36	518026	.36	1162014	.38
505057	.35	515018	.36	516048	.36	518027	.36	1162015	.38
505058	.35	515019	.36	517000	.36	518028	.36	1162034	.38
505059	.35	515020	.36	517001	.36	518029	.36	1162050	.38
505060	.35	515021	.36	517002	.36	518030	.36	1162075	.38
505061	.35	515022	.36	517003	.36	518031	.36	1163010	.38
505062	.35	515023	.36	517004	.36	518032	.36	1163014	.38
505063	.35	515024	.36	517005	.36	518033	.36	1163015	.38
505064	.35	515025	.36	517006	.36	518034	.36	1163034	.38
505065	.35	515026	.36	517007	.36	518035	.36	1163050	.38
505066	.35	515027	.36	517008	.36	518036	.36	1163075	.38
505067	.35	515030	.36	517009	.36	518037	.36	1181010	.38
505068	.35	515031	.36	517010	.36	518038	.36	1181014	.38
505069	.35	515032	.36	517011	.36	518039	.36	1181015	.38
505070	.35	515033	.36	517012	.36	518040	.36	1181025	.38
505071	.35	515034	.36	517013	.36	518043	.36	1181034	.38
505072	.35	515035	.36	517014	.36	518044	.36	1181050	.38
505073	.35	515036	.36	517015	.36	518045	.36	1181075	.38
505074	.35	515037	.36	517016	.36	518046	.36	1181208	.38
505075	.35	515038	.36	517017	.36	518047	.36	1182010	.38
505076	.35	515039	.36	517018	.36	518048	.36	1182014	.38
505077	.35	515040	.36	517019	.36	519000	.36	1182015	.38
505078	.35	515041	.36	517020	.36	519001	.36	1182025	.38
505079	.35	515042	.36	517021	.36	519002	.36	1182034	.38
505080	.35	515043	.36	517022	.36	519003	.36	1182050	.38
505081	.35	515044	.36	517023	.36	519004	.36	1182075	.38
505082	.35	515045	.36	517024	.36	519005	.36	1182208	.38
505083	.35	515046	.36	517025	.36	519006	.36	1183010	.38
505084	.35	515047	.36	517026	.36	519007	.36	1183014	.38
505085	.35	515048	.36	517027	.36	519008	.36	1183015	.38
505090	.35	516000	.36	517028	.36	519009	.36	1183025	.38
505091	.35	516001	.36	517029	.36	519010	.36	1183034	.38
505092	.35	516002	.36	517030	.36	519011	.36	1183050	.38
505093	.35	516003	.36	517031	.36	519012	.36	1183075	.38
505094	.35	516004	.36	517032	.36	519013	.36	1183208	.38
505095	.35	516005	.36	517033	.36	519014	.36	1212110	.42
505096	.35	516006	.36	517034	.36	519015	.36	1212116	.42
505097	.35	516007	.36	517035	.36	519016	.36	1212125	.42
505201	.35	516008	.36	517036	.36	519017	.36	1215110	.42
505202	.35	516009	.36	517037	.36	519018	.36	1215116	.42
505203	.35	516010	.36	517038	.36	519019	.36	1215125	.42
505204	.35	516011	.36	517039	.36	519020	.36	1218110	.42
505205	.35	516012	.36	517040	.36	519021	.36	1218116	.42
505206	.35	516013	.36	517043	.36	519022	.36	1218125	.42
505207	.35	516014	.36	517044	.36	519023	.36	1218135	.42
505208	.35	516015	.36	517045	.36	519024	.36	1218150	.42
505209	.35	516016	.36	517046	.36	519025	.36	1220110	.42
505210	.35	516017	.36	517047	.36	519026	.36	1220116	.42
505310	.35	516018	.36	517048	.36	519027	.36	1220135	.42
505320	.35	516019	.36	518000	.36	519028	.36	1222150	.42
505330	.35	516020	.36	518001	.36	519029	.36	1225110	.42
505650	.35	516021	.36	518002	.36	519030	.36	1225116	.42
505710	.35	516022	.36	518003	.36	519031	.36	1225125	.42
505720	.35	516023	.36	518004	.36	519032	.36	1225135	.42
505850	.35	516024	.36	518005	.36	519033	.36	1225150	.42
505910	.35	516025	.36	518006	.36	519034	.36	1225170	.42
505915	.35	516026	.36	518007	.36	519035	.36	1225195	.43
505920	.35	516027	.36	518008	.36	519036	.36	1230195	.43
515000	.36	516030	.36	518009	.36	519037	.36	1232116	.42
515001	.36	516031	.36	518010	.36	519038	.36	1232125	.42
515002	.36	516032	.36	518011	.36	519039	.36	1232135	.42
515003	.36	516033	.36	518012	.36	519040	.36	1232150	.42
515004	.36	516034	.36	518013	.36	519043	.36	1232170	.42
515005	.36	516035	.36	518014	.36	519044	.36	1232195	.43
515006	.36	516036	.36	518015	.36	519045	.36	1232195	.42
515007	.36	516037	.36	518016	.36	519046	.36	1381010	.41
515008	.36	516038	.36	518017	.36	519047	.36	1381015	.41
515009	.36	516039	.36	518018	.36	519048	.36	1381050	.41
515010	.36	516040	.36	518019	.36	1161010	.38	1381075	.41
515011	.36	516041	.36	518020	.36	1161014	.38	1382010	.41
515012	.36	516042	.36	518021	.36	1161015	.38	1382015	.41
515013	.36	516043	.36	518022	.36	1161034	.38	1382050	.41
515014	.36	516044	.36	518023	.36	1161050	.38	1382075	.41
515015	.36	516045	.36	518024	.36	1161075	.38	1383075	.41



# INDEX

PART #	PAGE #	PART #	PAGE #	PART #	PAGE #	PART #	PAGE #	PART #	PAGE #
1617050	.45	11182160	.38	112721200	.39	1100.21.205	.86	1555.20.07	.87
1617400	.45	11182250	.39	112731200	.39	1100.25.205	.85	1555.20.12	.87
1627050	.45	11182350	.39	113211500	.39	1100.29.190	.86	1555.21.06	.87
1627400	.45	11183015	.38	113221500	.39	1100.29.230	.86	1555.21.14	.87
2541000	.75	11183025	.38	121010050	.42	1100.29.275	.86	1555.21.18	.87
2541100	.75	11183040	.38	121010075	.42	1100.32.170	.85	1555.25.14	.87
2543000	.75	11183060	.38	121010100	.42	1100.32.210	.85	1555.25.18	.87
2543100	.75	11183100	.38	121010150	.42	1100.32.255	.85	1555.29.25	.87
2544000	.75	11183160	.38	121010250	.42	1100.36.260	.86	1555.32.25	.87
2544100	.75	11183250	.39	121010400	.42	1100.36.305	.86	1555.36.33	.87
2561000	.75	11183350	.39	121010600	.42	1100.36.350	.86	1555.42.38	.87
2561100	.75	11201500	.39	121210075	.42	1100.40.240	.85	1555.48.44	.87
2563000	.75	11201700	.39	121210100	.42	1100.40.285	.85	1555.N01000.22	.88
2563100	.75	11202500	.39	121210150	.42	1100.40.330	.85	1555.N0375.08	.88
2564000	.75	11202700	.39	121210250	.42	1100.42.330	.86	1555.N0500.07	.88
2564100	.75	11203500	.39	121210400	.42	1100.42.370	.86	1555.N0500.12	.88
11101010	.38	11203700	.39	121210600	.42	1100.42.420	.86	1555.N0750.14	.88
11101015	.38	11221250	.39	121510150	.42	1100.48.370	.86	1555.N0750.18	.88
11101025	.38	11222250	.39	121510250	.42	1100.48.430	.86	1576.07.06	.89
11101040	.38	11251350	.39	121510400	.42	1100.48.490	.86	1576.09.08	.89
11101050	.38	11251500	.39	121510600	.42	1100.50.330	.85	1576.11.07	.89
11101075	.38	11251950	.39	121810150	.42	1100.50.370	.85	1576.11.10	.89
11102010	.38	11252350	.39	121810250	.42	1100.50.420	.85	1576.13.07	.89
11102015	.38	11252500	.39	121810400	.42	1100.63.400	.85	1576.13.12	.89
11102040	.38	11252950	.39	121810600	.42	1100.63.460	.85	1576.16.11	.89
11102050	.38	11253250	.39	122010150	.42	1100.63.520	.85	1576.16.14	.89
11102075	.38	11253350	.39	122010250	.42	1100.75.500	.85	16040U	.44
11103010	.38	11253500	.39	122010400	.42	1100.75.560	.85	16050T	.44
11103015	.38	11271700	.39	122010600	.42	1100.75.630	.85	16050U	.44
11103040	.38	11272700	.39	123211500	.43	1100G	.39	16075T	.44
11103050	.38	11273700	.39	123211850	.43	1150G	.39	16150T	.44
11103075	.38	11610025	.38	123811500	.43	1160G	.39	1617050T	.45
11121010	.38	11620025	.38	124011850	.43	1545.07.06	.88	1627050T	.45
11121015	.38	11630025	.38	01000.LN	.90	1545.09.08	.88	19201-11	.79
11121025	.38	11810025	.38	0375.LN	.90	1545.11.07	.88	19202-11	.79
11121040	.38	11820025	.38	0500.LN	.90	1545.11.10	.88	19203-11	.79
11121060	.38	11830025	.38	0750.LN	.90	1545.12.06	.87	19205-11	.80
11121075	.38	12321120	.43	10401-11	.79	1545.13.07	.88	19206-11	.80
11121100	.38	12401120	.43	1050G	.39	1545.13.12	.88	19207-11	.80
11121160	.38	12510025	.42	1075G	.39	1545.16.11	.88	19208-11	.80
11122010	.38	12510034	.42	1100.06.025	.85	1545.16.14	.88	19210-11	.79
11122015	.38	12610050	.42	1100.06.030	.85	1545.17.08	.87	19211-11	.79
11122025	.38	12610075	.42	1100.06.035	.85	1545.20.07	.87	19212-11	.79
11122040	.38	12610100	.42	1100.07.050	.86	1545.20.12	.87	19213-11	.79
11122060	.38	12710025	.42	1100.07.065	.86	1545.21.14	.88	19215-11	.80
11122075	.38	12710034	.42	1100.07.080	.86	1545.21.18	.88	19216-11	.80
11122100	.38	12710100	.42	1100.08.035	.85	1545.25.14	.87	19217-11	.80
11122160	.38	12710150	.42	1100.08.050	.85	1545.25.18	.87	19218-11	.80
11123010	.38	12710250	.42	1100.09.045	.86	1545.29.25	.88	19300-11	.79
11123015	.38	12810050	.42	1100.09.060	.86	1545.32.25	.87	19400-11	.79
11123025	.38	12810075	.42	1100.09.080	.86	1545.36.33	.88	19535-100	.79
11123040	.38	12810100	.42	1100.09.105	.86	1545.42.38	.88	19535-200	.79
11123060	.38	12810150	.42	1100.10.040	.85	1545.48.44	.88	19535-300	.79
11123075	.38	12910400	.42	1100.10.060	.85	1545.N0375.08	.88	2050G	.39
11123100	.38	13101010	.41	1100.11.055	.86	1545.N0500.07	.88	2075G	.39
11123160	.38	13101025	.41	1100.11.085	.86	1545.N0750.14	.88	2100G	.39
11161250	.39	13101075	.41	1100.11.120	.86	1545.N0750.18	.88	2150G	.39
11161350	.39	13102010	.41	1100.12.050	.85	1545.N1000.22	.88	2160G	.39
11162250	.39	13102025	.41	1100.12.065	.85	1546.07.06	.89	3050G	.39
11162350	.39	13102075	.41	1100.12.080	.85	1546.09.08	.89	3075G	.39
11163250	.39	13103075	.41	1100.13.080	.86	1546.11.07	.89	3100G	.39
11163350	.39	13121010	.41	1100.13.110	.86	1546.11.10	.89	3150G	.39
11181015	.38	13121015	.41	1100.13.150	.86	1546.13.07	.89	3160G	.39
11181025	.38	13121040	.41	1100.16.080	.86	1546.13.12	.89	8748.48.08	.92
11181040	.38	13122015	.41	1100.16.110	.86	1546.16.11	.89	CIRCUIT BREAKERS	
11181060	.38	13122040	.41	1100.16.150	.86	1546.16.14	.89	UL1077	.72
11181100	.38	13131025	.41	1100.17.045	.85	1555.07.06	.87	CIRCUIT BREAKERS	
11181160	.38	13132025	.41	1100.17.060	.85	1555.09.08	.87	UL489	.72
11181250	.39	13141060	.41	1100.17.080	.85	1555.11.07	.87	CIRCUIT BREAKERS	
11181350	.39	13141100	.41	1100.17.105	.85	1555.11.10	.87	UL489A	.73
11182015	.38	13142060	.41	1100.20.080	.85	1555.13.07	.87	CRIMPKIT	.45
11182025	.38	13142100	.41	1100.20.110	.85	1555.13.12	.87	CUT6	.55
11182040	.38	13161160	.41	1100.20.150	.85	1555.16.11	.87	DIN120GFCI	.70
11182060	.38	13162160	.41	1100.21.125	.86	1555.16.14	.87	DR-120-24	.66
11182100	.38	112711200	.39	1100.21.160	.86	1555.17.08	.87	DR-45-24	.67

# INDEX

PART #	PAGE #	PART #	PAGE #	PART #	PAGE #	PART #	PAGE #	PART #	PAGE #
DR-75-24	.66	IND20-6L	.54	T-332-381M2	.98				
DRP-240-24	.65	LC100	.59	T-332-381M3	.98				
DRP-480S-24	.65	LUG20-10	.55	T-362-500M2	.99				
DRT-240-24	.64	MC1050	.40	T-362-500M3	.99				
DRT-480-24	.64	MC1075	.40	T-362-508M2	.99				
DSUB-15-MF	.77	MC1100	.40	T-362-508M3	.99				
DSUB-15-MF-CBL	.77	MC1150	.40	TRAP12-8TW	.54				
DSUB-25-MF	.77	MC1250	.40	TRAP2-1	.53				
DSUB-25-MF-CBL	.77	MC2050	.40	TRAP22-10	.53				
DSUB-9-MF	.77	MC2075	.40	TRAP24-10	.53				
DSUB-9-MF-CBL	.77	MC2100	.40	TRAP24-10F	.53				
F2400125	.67	MC2150	.40	TRAP24-14L	.54				
F240025	.68	MC2250	.40	TRAP8-1	.53				
F240050	.68	MC25	.56	TRAP8-4	.53				
F240050S	.67	MC3050	.40	TS3515SL	.61				
F24010	.69	MC3075	.40	TS3515SOL	.61				
F24010S	.67	MC3100	.40	TS3515SOLH	.61				
F24010S-3	.68	MC3150	.40	TS3575SL	.61				
F24020	.69	MC3250	.40	TS3575SL1	.61				
F24020-3	.69	P-100-50002	.100	TS3575SL1-A	.61				
F24020S-3	.68	P-100-50003	.100	TS3575SOL	.61				
F24040-3	.69	P-100-50006	.100	TS3CUT	.62				
H-030-35002	.102	P-100-50008	.100	VICE70150	.55				
H-030-35003	.102	P-100-50012	.100	W900832	.107				
H-030-35006	.102	P-100-50802	.100	W900833	.107				
H-030-35008	.102	P-100-50803	.100	W900834	.107				
H-030-35012	.102	P-100-50804	.100	W900836	.107				
H-030-38102	.102	P-100-50806	.100	W900837	.107				
H-030-38103	.102	P-100-50808	.100	W900838	.107				
H-030-38104	.102	P-100-50810	.100	W900839	.107				
H-030-38106	.102	P-100-50812	.100	W900840	.107				
H-030-38107	.102	P-200-50002	.100	W900841	.107				
H-030-38108	.102	P-200-50003	.100	W900844	.107				
H-030-38109	.102	P-200-50006	.100	W900857	.107				
H-030-38112	.102	P-200-50008	.100	W900858	.107				
H-030-50002	.103	P-200-50010	.100						
H-030-50003	.103	P-200-50012	.100						
H-030-50006	.103	P-200-50802	.100						
H-030-50008	.103	P-200-50803	.100						
H-030-50012	.103	P-200-50804	.100						
H-030-50802	.103	P-200-50806	.100						
H-030-50803	.103	P-200-50808	.100						
H-030-50806	.103	P-200-50812	.100						
H-030-50808	.103	P-420-35002	.101						
H-030-50810	.103	P-420-35003	.101						
H-030-50812	.103	P-420-35006	.101						
H-040-35002	.104	P-420-35008	.101						
H-040-35003	.104	P-420-35012	.101						
H-040-35006	.104	P-420-38102	.101						
H-040-35008	.104	P-420-38103	.101						
H-040-35012	.104	P-420-38104	.101						
H-040-38102	.104	P-420-38105	.101						
H-040-38103	.104	P-420-38106	.101						
H-040-38105	.104	P-420-38107	.101						
H-040-38106	.104	P-420-38108	.101						
H-040-38108	.104	P-420-38109	.101						
H-040-38112	.104	P-420-38112	.101						
H-040-50002	.105	P-421-38109	.101						
H-040-50003	.105	PC12-8B	.58						
H-040-50006	.105	PC12-8H	.58						
H-040-50008	.105	PC24-14B	.58						
H-040-50010	.105	PC24-14H	.58						
H-040-50012	.105	SQ28-10	.54						
H-040-50802	.105	STCR204-14	.54						
H-040-50803	.105	STRIP28-10	.55						
H-040-50804	.105	T-212-350M2	.97						
H-040-50806	.105	T-212-350M3	.97						
H-040-50808	.105	T-312-500M2	.97						
H-040-50812	.105	T-312-500M3	.97						
IDC-20-M	.77	T-312-508M2	.97						
IDC-20-M-CBL	.77	T-312-508M3	.97						
IDC-24-M	.77	T-312-750M2	.98						
IDC-24-M-CBL	.77	T-312-750M3	.98						
IDC-40-M	.77	T-312-762M2	.98						
IND20-14L	.54	T-312-762M3	.98						

- **DIN RAIL MOUNTED TERMINAL BLOCKS**
- **WIRE FERRULES**
- **TOOLS**
- **DIN RAIL**
- **DIN RAIL MOUNTED POWER SUPPLIES**
- **DIN RAIL MOUNTED CIRCUIT BREAKERS**
- **DIN RAIL MOUNTED FUSE HOLDERS**
- **DIN RAIL MOUNTED INTERFACE MODULES**
- **DIN RAIL MOUNTED DISCONNECT SWITCHES**
- **CABLE GLANDS**
- **PRINTED CIRCUIT BOARDS**
- **SCREWDRIVERS**



**AMERICAN ELECTRICAL, INC.**  
**425 SOUTHLAKE BLVD., SUITE 9-B**  
**RICHMOND, VA 23236**  
**804.379.2899**  
**FAX: 804.379.8935**  
**[WWW.AMERICANELECTRICAL.COM](http://WWW.AMERICANELECTRICAL.COM)**



spine