

## Description

The ZMR250Q/ZMR330Q/ZMR500Q of three terminal fixed positive voltage regulators feature internal current limit and will shut down under thermal overload conditions making the devices difficult to destroy.

The circuit design offers an exceptionally low quiescent current, only 30µA for the 2.5V device, ideal for low power applications. The initial devices in the series regulate to 2.5V or 5V with a drive capability up to 50mA.

All three devices are designed with space saving in mind and are available in the small outline SOT23 (Type DN) package. All three have an input voltage range of at least 20V plus the output voltage.

The ZMR250Q, ZMR330Q and ZMR500Q have been qualified to AEC-Q100 Grade 1 and are Automotive Compliant supporting PPAPs.

## Features

- 2.5V, 3.3V and 5V Output
- Output Current up to 50mA
- Very Low Quiescent Current (30µA)
- Unconditionally Stable
- Internal Short Circuit Current Limit
- Green Molding in SOT23 (Type DN)
- **Totally Lead-Free & Fully RoHS Compliant (Notes 1 & 2)**
- **Halogen and Antimony Free. "Green" Device (Note 3)**
- Automotive Compliant
- **Qualified to AEC-Q100 Standards for High Reliability**
- **PPAP Capable (Note 4)**

- Notes:
1. No purposely added lead. Fully EU Directive 2002/95/EC (RoHS) & 2011/65/EU (RoHS 2) compliant.
  2. See [http://www.diodes.com/quality/lead\\_free.html](http://www.diodes.com/quality/lead_free.html) for more information about Diodes Incorporated's definitions of Halogen- and Antimony-free, "Green" and Lead-free.
  3. Halogen- and Antimony-free "Green" products are defined as those which contain <900ppm bromine, <900ppm chlorine (<1500ppm total Br + Cl) and <1000ppm antimony compounds.
  4. Automotive products are AEC-Q100 qualified and are PPAP capable. [http://www.diodes.com/product\\_compliance\\_definitions.html](http://www.diodes.com/product_compliance_definitions.html).

## Pin Assignments

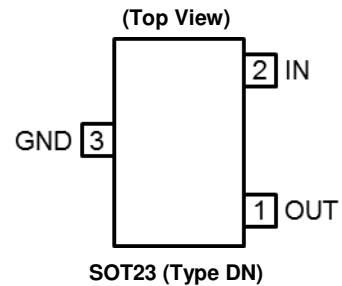

## Applications

- Automotive Point of Load Regulation

## Equivalent Circuit

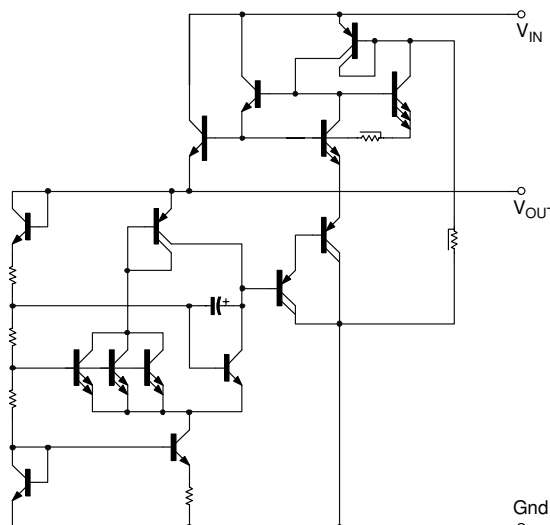

### Absolute Maximum Ratings

Parameter	Rating	Unit
Input Voltage (Note 5) ZMR250Q ZMR330Q ZMR500Q	22.5 24 25	V
Power Dissipation (T <sub>A</sub> = +25°C) (Note 6) SOT23 (Type DN)	500	mW
Output Current (I <sub>O</sub> )	100	mA
Ambient Temperature	-55 to +125	°C
Maximum Junction Temperature	+125	°C
Storage Temperature	-65 to +150	°C
ESD Rating		
HBM	Human Body Model	1.5 kV
MM	Machine Model	350 V
CDM	Charged Device Model	1 kV

Caution: Stresses greater than the 'Absolute Maximum Ratings' specified above, may cause permanent damage to the device. These are stress ratings only; functional operation of the device at conditions between maximum recommended operating conditions and absolute maximum ratings is not implied. Device reliability may be affected by exposure to absolute maximum rating conditions for extended periods of time.

(Semiconductor devices are ESD sensitive and may be damaged by exposure to ESD events. Suitable ESD precautions should be taken when handling and transporting these devices.)

- Notes:
- The maximum operating input voltage and output current of the device will be governed by the maximum power dissipation of the selected package. Maximum package power dissipation is specified at +25°C and must be linearly derated to zero at T<sub>A</sub> = T<sub>J</sub> = +125°C.
  - Maximum power dissipation for the SOT23 (Type DN) package is calculated assuming that the device is mounted on a ceramic substrate measuring 15mm x 15mm x 0.6mm.

### Recommended Operating Conditions

Input Voltage Range	Min	Max	Unit
ZMR250Q	4.2	22.5	V
ZMR330Q	4.8	24	V
ZMR500Q	7.0	25	V
Junction Temperature Range	-40	+125	°C
Ambient Temperature Range	-40	+125	°C

**Electrical Characteristics** (@ $T_A = +25^\circ\text{C}$ ,  $I_O = 10\text{mA}$ ,  $V_{IN} = 6.5\text{V}$ , unless otherwise specified.)

**ZMR250Q**

Symbol	Parameter	Condition	Min	Typ	Max	Unit
$V_O$	Output Voltage	—	2.438	2.5	2.563	V
		—	2.360	—	2.640	V
		$V_{IN} = 4.5\text{V to } 22.5\text{V}$ $T_J = -40^\circ\text{C to } +125^\circ\text{C}$	2.360	—	2.640	V
$\Delta V_O$	Line Regulation	$V_{IN} = 4.5\text{V to } 22.5\text{V}$	—	5	15	mV
$\Delta V_O$	Load Regulation	$I_O = 0 \text{ to } 50\text{mA}$	—	20	30	mV
		$I_O = 0 \text{ to } 10\text{mA}$	—	12	—	
$I_S$	Supply Current	$T_J = -40^\circ\text{C to } +125^\circ\text{C}$	—	30	40	$\mu\text{A}$
$\Delta I_S$	Supply Current Change	$I_O = 0 \text{ to } 50\text{mA}$	—	1	$\pm 10$	$\mu\text{A}$
		$V_{IN} = 4.5\text{V to } 22.5\text{V}$	—	2	$\pm 10$	
$V_N$	Output Noise Voltage	$f = 10\text{Hz to } 10\text{kHz}$	—	65	—	$\mu\text{Vrms}$
$\Delta V_{IN}/\Delta V_O$	Ripple Rejection	$V_{IN} = 6.3\text{V to } 18\text{V}$ , $f = 120\text{Hz}$	55	75	—	dB
$V_{IN}$	Input Voltage Required to Maintain Regulation	—	—	3.9	—	V
$\Delta V_O/\Delta T$	Average Temperature Coefficient $V_O$	$I_O = 5.0\text{mA}$ $T_J = -40^\circ\text{C to } +125^\circ\text{C}$	—	0.275	0.700	$\text{mV}/^\circ\text{C}$

**Electrical Characteristics** (@ $T_A = +25^\circ\text{C}$ ,  $I_O = 10\text{mA}$ ,  $V_{IN} = 7\text{V}$ , unless otherwise specified.)

**ZMR330Q**

Symbol	Parameter	Condition	Min	Typ	Max	Unit
$V_O$	Output Voltage	—	3.217	3.3	3.383	V
		—	3.148	—	3.393	V
		$V_{IN} = 5\text{V to } 24\text{V}$ $T_J = -40^\circ\text{C to } +125^\circ\text{C}$	3.148	—	3.408	V
$\Delta V_O$	Line Regulation	$V_{IN} = 5\text{V to } 24\text{V}$	—	5	15	mV
$\Delta V_O$	Load Regulation	$I_O = 0 \text{ to } 50\text{mA}$	—	20	50	mV
		$I_O = 0 \text{ to } 10\text{mA}$	—	13	—	
$I_S$	Supply Current	$T_J = -40^\circ\text{C to } +125^\circ\text{C}$	—	120	170	$\mu\text{A}$
$\Delta I_S$	Supply Current Change	$I_O = 0 \text{ to } 50\text{mA}$	—	5	$\pm 10$	$\mu\text{A}$
		$V_{IN} = 5\text{V to } 20\text{V}$	—	2	$\pm 10$	
$V_N$	Output Noise Voltage	$f = 10\text{Hz to } 10\text{kHz}$	—	80	—	$\mu\text{Vrms}$
$\Delta V_{IN}/\Delta V_O$	Ripple Rejection	$V_{IN} = 6\text{V to } 20\text{V}$ , $f = 120\text{Hz}$	55	—	—	dB
$V_{IN}$	Input Voltage Required to Maintain Regulation	—	—	4.74	—	V

**Electrical Characteristics** (@ $T_A = +25^\circ\text{C}$ ,  $I_O = 10\text{mA}$ ,  $V_{IN} = 10\text{V}$ , unless otherwise specified.)

**ZMR500Q**

Symbol	Parameter	Condition	Min	Typ	Max	Unit
$V_O$	Output Voltage	—	4.875	5	5.125	V
		—	4.780	—	5.160	V
		$V_{IN} = 7\text{V to } 25\text{V}$ $T_J = -40^\circ\text{C to } +125^\circ\text{C}$	4.780	—	5.175	V
$\Delta V_O$	Line Regulation	$V_{IN} = 7\text{V to } 25\text{V}$	—	5	15	mV
$\Delta V_O$	Load Regulation	$I_O = 0 \text{ to } 50\text{mA}$	—	25	40	mV
		$I_O = 0 \text{ to } 10\text{mA}$	—	15	—	
$I_S$	Supply Current	$T_J = -40^\circ\text{C to } +125^\circ\text{C}$	—	50	70	$\mu\text{A}$
$\Delta I_S$	Supply Current Change	$I_O = 0 \text{ to } 50\text{mA}$	—	1	$\pm 10$	$\mu\text{A}$
		$V_{IN} = 7\text{V to } 25\text{V}$	—	2	$\pm 10$	
$V_N$	Output Noise Voltage	$f = 10\text{Hz to } 10\text{kHz}$	—	90	—	$\mu\text{Vrms}$
$\Delta V_{IN}/\Delta V_O$	Ripple Rejection	$V_{IN} = 8\text{V to } 18\text{V}$ , $f = 120\text{Hz}$	55	72	—	dB
$V_{IN}$	Input Voltage Required to Maintain Regulation	—	—	6.7	—	V
$\Delta V_O/\Delta T$	Average Temperature Coefficient $V_O$	$I_O = 5.0\text{mA}$ , $T_J = -40^\circ\text{C to } +125^\circ\text{C}$	—	0.275	0.700	$\text{mV}/^\circ\text{C}$

**Typical Characteristics**

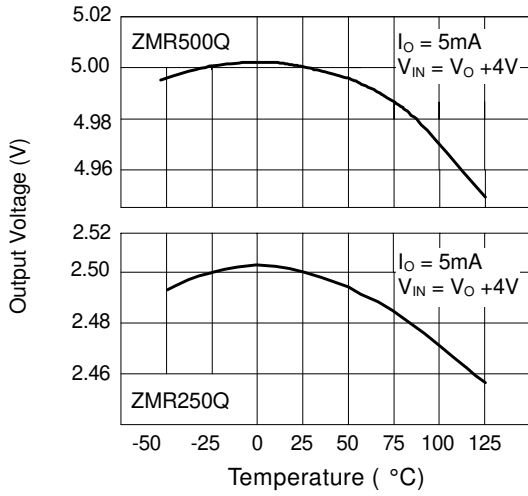

Output Voltage vs. Temperature

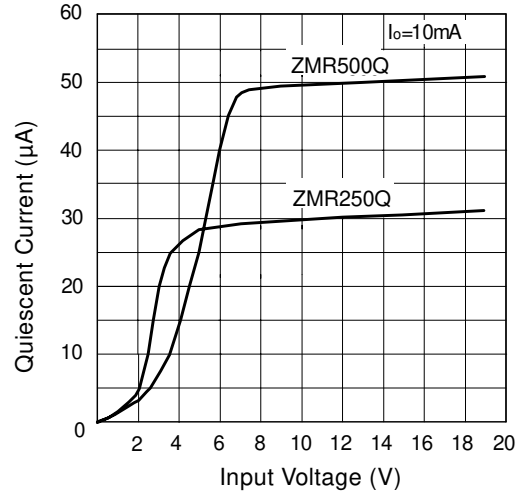

Quiescent Current vs. Input Voltage

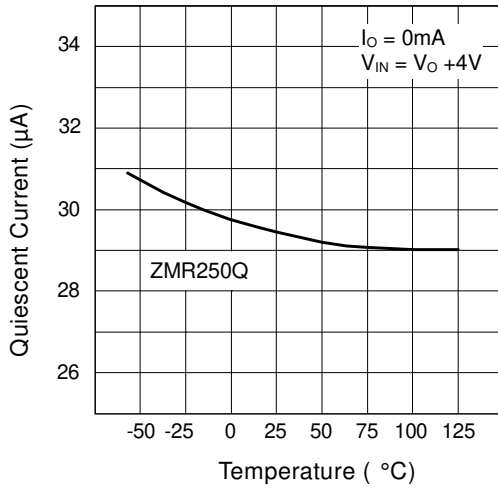

Quiescent Current vs. Temperature

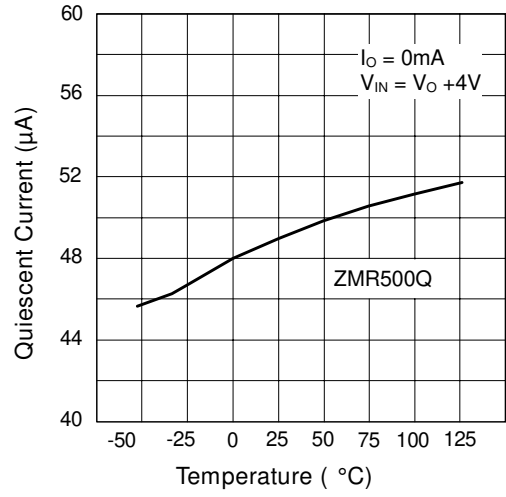

Quiescent Current vs. Temperature

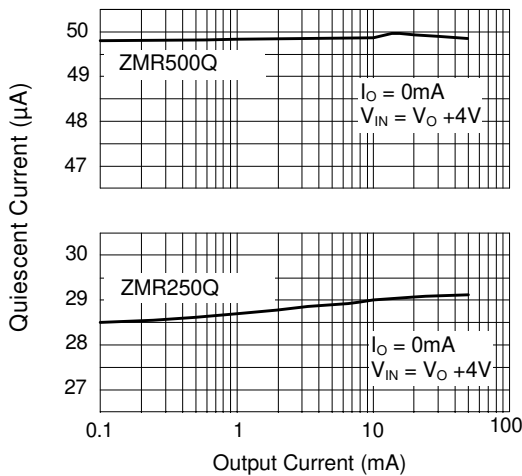

Quiescent Current vs. Output Current

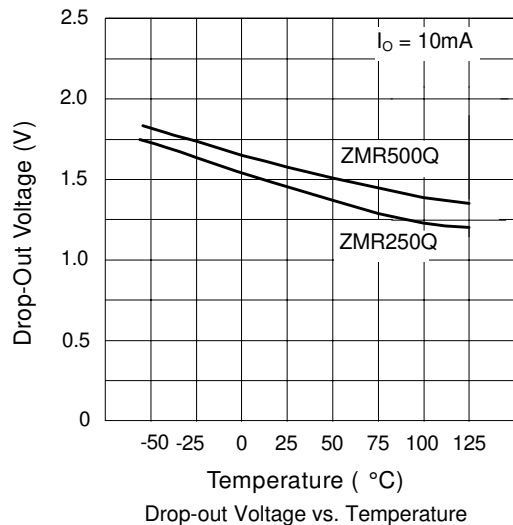

Drop-out Voltage vs. Temperature

**Typical Characteristics (Cont.)**

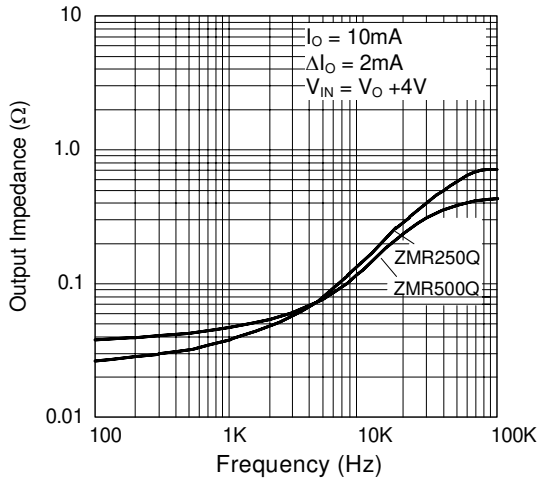

Output Impedance v Frequency

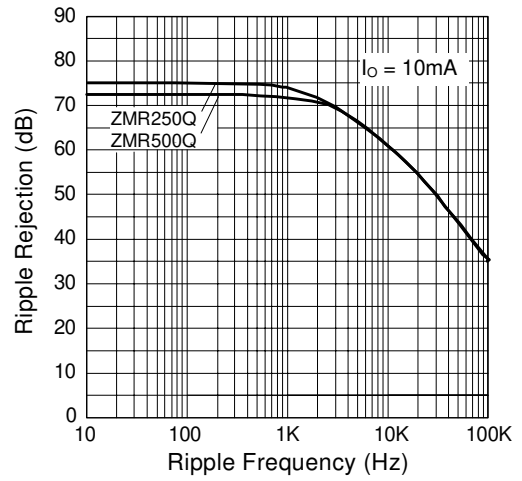

Ripple Rejection v Ripple Frequency

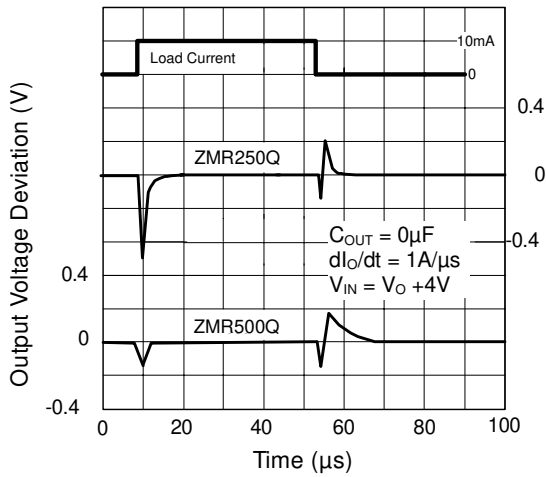

Load Transient Response

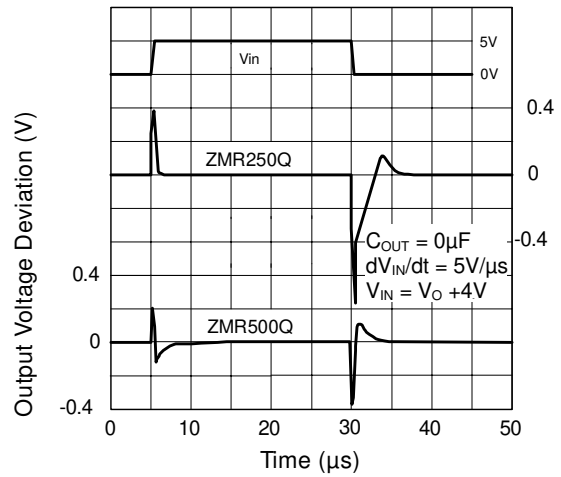

Line Transient Response

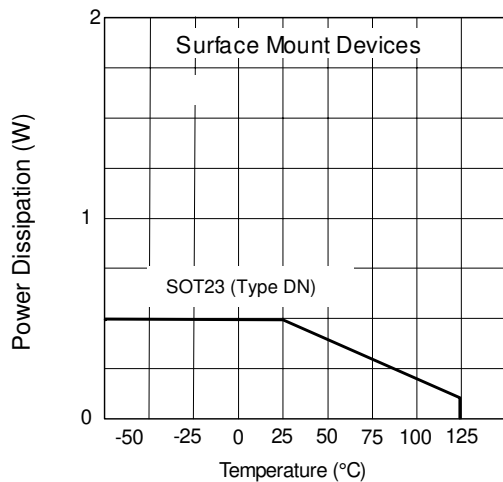

Power Derating

## Ordering Information

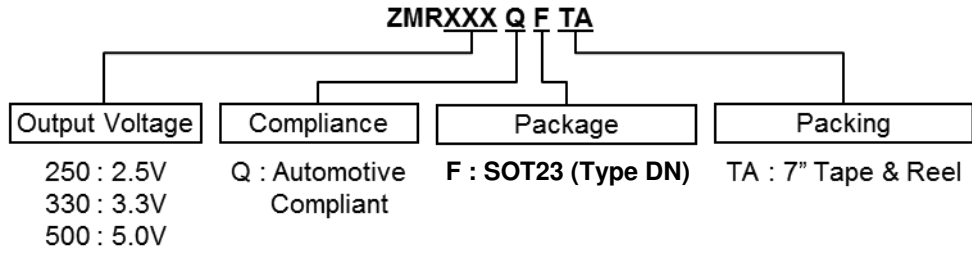

Part Number	Package	Package Code	Identification Code	Packing: 7" Tape and Reel			Qualification Grade (Note 7)
				Quantity	Tape Width	Part Number Suffix	
ZMR250QFTA	SOT23 (Type DN)	F	25K	3000	8mm	TA	Automotive Compliant
ZMR330QFTA	SOT23 (Type DN)	F	330	3000	8mm	TA	Automotive Compliant
ZMR500QFTA	SOT23 (Type DN)	F	50K	3000	8mm	TA	Automotive Compliant

Note: 7. ZMR250Q, ZMR330Q and ZMR500Q have been qualified to AEC-Q100 grade 1 and are classified as "Automotive Compliant" which supports PPAP documentation. See ZMR250/330/500 datasheet for commercial qualified versions.

## Marking Information

SOT23 (Type DN)

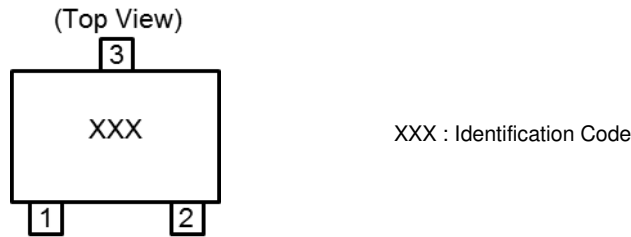

**Package Outline Dimensions**

Please see <http://www.diodes.com/package-outlines.html> for the latest version.

**SOT23 (Type DN)**

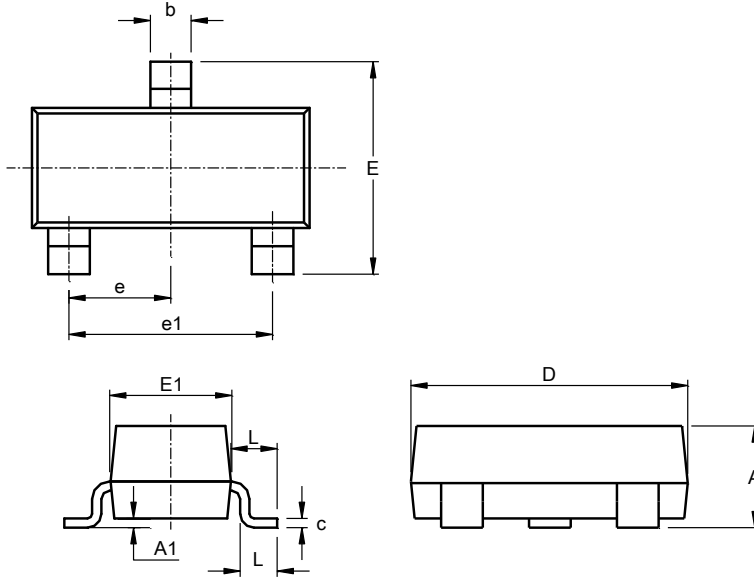

SOT23 (Type DN)			
Dim	Min	Max	Typ
A	0.89	1.12	1.00
A1	0.01	0.10	0.05
b	0.30	0.51	0.45
c	0.08	0.20	0.10
D	2.80	3.04	3.00
E	2.10	2.64	2.42
E1	1.20	1.40	1.37
e	0.95 REF		
e1	1.90 REF		
L	0.25	0.60	0.30
L1	0.45	0.62	0.54
All Dimensions in mm			

**Suggested Pad Layout**

Please see <http://www.diodes.com/package-outlines.html> for the latest version.

**SOT23 (Type DN)**

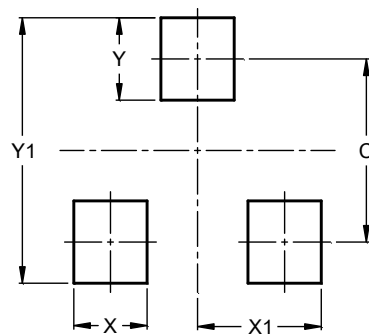

Dimensions	Value (in mm)
C	2.0
X	0.8
X1	1.35
Y	0.9
Y1	2.9

**IMPORTANT NOTICE**

DIODES INCORPORATED MAKES NO WARRANTY OF ANY KIND, EXPRESS OR IMPLIED, WITH REGARDS TO THIS DOCUMENT, INCLUDING, BUT NOT LIMITED TO, THE IMPLIED WARRANTIES OF MERCHANTABILITY AND FITNESS FOR A PARTICULAR PURPOSE (AND THEIR EQUIVALENTS UNDER THE LAWS OF ANY JURISDICTION).

Diodes Incorporated and its subsidiaries reserve the right to make modifications, enhancements, improvements, corrections or other changes without further notice to this document and any product described herein. Diodes Incorporated does not assume any liability arising out of the application or use of this document or any product described herein; neither does Diodes Incorporated convey any license under its patent or trademark rights, nor the rights of others. Any Customer or user of this document or products described herein in such applications shall assume all risks of such use and will agree to hold Diodes Incorporated and all the companies whose products are represented on Diodes Incorporated website, harmless against all damages.

Diodes Incorporated does not warrant or accept any liability whatsoever in respect of any products purchased through unauthorized sales channel. Should Customers purchase or use Diodes Incorporated products for any unintended or unauthorized application, Customers shall indemnify and hold Diodes Incorporated and its representatives harmless against all claims, damages, expenses, and attorney fees arising out of, directly or indirectly, any claim of personal injury or death associated with such unintended or unauthorized application.

Products described herein may be covered by one or more United States, international or foreign patents pending. Product names and markings noted herein may also be covered by one or more United States, international or foreign trademarks.

This document is written in English but may be translated into multiple languages for reference. Only the English version of this document is the final and determinative format released by Diodes Incorporated.

**LIFE SUPPORT**

Diodes Incorporated products are specifically not authorized for use as critical components in life support devices or systems without the express written approval of the Chief Executive Officer of Diodes Incorporated. As used herein:

A. Life support devices or systems are devices or systems which:

1. are intended to implant into the body, or
2. support or sustain life and whose failure to perform when properly used in accordance with instructions for use provided in the labeling can be reasonably expected to result in significant injury to the user.

B. A critical component is any component in a life support device or system whose failure to perform can be reasonably expected to cause the failure of the life support device or to affect its safety or effectiveness.

Customers represent that they have all necessary expertise in the safety and regulatory ramifications of their life support devices or systems, and acknowledge and agree that they are solely responsible for all legal, regulatory and safety-related requirements concerning their products and any use of Diodes Incorporated products in such safety-critical, life support devices or systems, notwithstanding any devices- or systems-related information or support that may be provided by Diodes Incorporated. Further, Customers must fully indemnify Diodes Incorporated and its representatives against any damages arising out of the use of Diodes Incorporated products in such safety-critical, life support devices or systems.

Copyright © 2017, Diodes Incorporated

[www.diodes.com](http://www.diodes.com)