



**11.7 Volt Temperature Compensated Zener Reference Diodes**  
 Qualified per MIL-PRF-19500/157

*\*Qualified Levels:  
 JAN, JANTX,  
 JANTXV and JANS  
 (available on some part numbers)*

**DESCRIPTION**

The popular 1N941UR-1 thru 1N945BUR-1 series of Zero-TC Reference Diodes provides a selection of 11.7 V nominal voltages and temperature coefficients to as low as 0.0002 %/°C for minimal voltage change with temperature when operated at 7.5 mA. Some of these glass, DO-213AA reference diodes are also available in JAN, JANTX, JANTXV and JANS military qualifications. Microsemi also offers numerous other Zener Reference Diode products for a variety of other voltages from 6.2 V to 200 V.

**Important:** For the latest information, visit our website <http://www.microsemi.com>.

**FEATURES**

- Surface mount equivalent of the JEDEC registered 1N941 thru 1N945 series.
- Standard reference voltage of 11.7 V +/- 5% with tighter tolerances also available for commercial.
- Internal metallurgical bond.
- \*JAN, JANTX, JANTXV and JANS qualification per MIL-PRF-19500/157 available on 1N941BUR-1, 1N943BUR-1, 1N944BUR-1, and 1N945BUR-1.
- RoHS compliant versions available (commercial grade only).

**APPLICATIONS / BENEFITS**

- Provides minimal voltage changes over a broad temperature range.
- For instrumentation and other circuit designs requiring a stable voltage reference.
- Maximum temperature coefficient selections available from 0.01 %/°C to 0.0005 %/°C.
- Non-sensitive to ESD per MIL-STD-750, method 1020.

**MAXIMUM RATINGS**

Parameters/Test Conditions	Symbol	Value	Unit
Power Dissipation @ T <sub>L</sub> = 25 °C and maximum current I <sub>ZM</sub> of 39 mA. <sup>(1, 2)</sup>	P <sub>D</sub>	500	mW
Junction and Storage Temp	T <sub>J</sub> and T <sub>STG</sub>	-55 to +175	°C
Maximum Zener Current	I <sub>ZM</sub>	39	mA
Solder Temperature @ 10 s	T <sub>SP</sub>	260	°C

**Notes:** 1. For optimum voltage-temperature stability, I<sub>Z</sub> = 7.5 mA (less than 95 mW in dissipated power).  
 2. Derate at 3.33 mW/°C above T<sub>A</sub> = +25 °C.



**DO-213AA Package**

Also available in:

**DO-35 (DO-204AH)**  
 (axial-leaded)

 [1N941-1 thru 1N945B-1](#)

**MSC – Lawrence**  
 6 Lake Street,  
 Lawrence, MA 01841  
 1-800-446-1158  
 Tel: (978) 620-2600  
 Fax: (978) 689-0803

**MSC – Ireland**  
 Gort Road Business Park,  
 Ennis, Co. Clare, Ireland  
 Tel: +353 (0) 65 6840044  
 Fax: +353 (0) 65 6822298

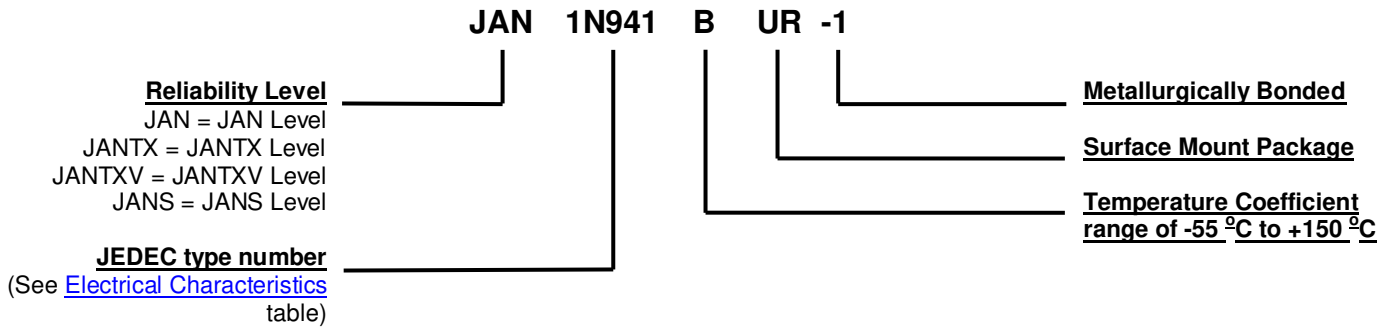
**Website:**  
[www.microsemi.com](http://www.microsemi.com)

**MECHANICAL and PACKAGING**

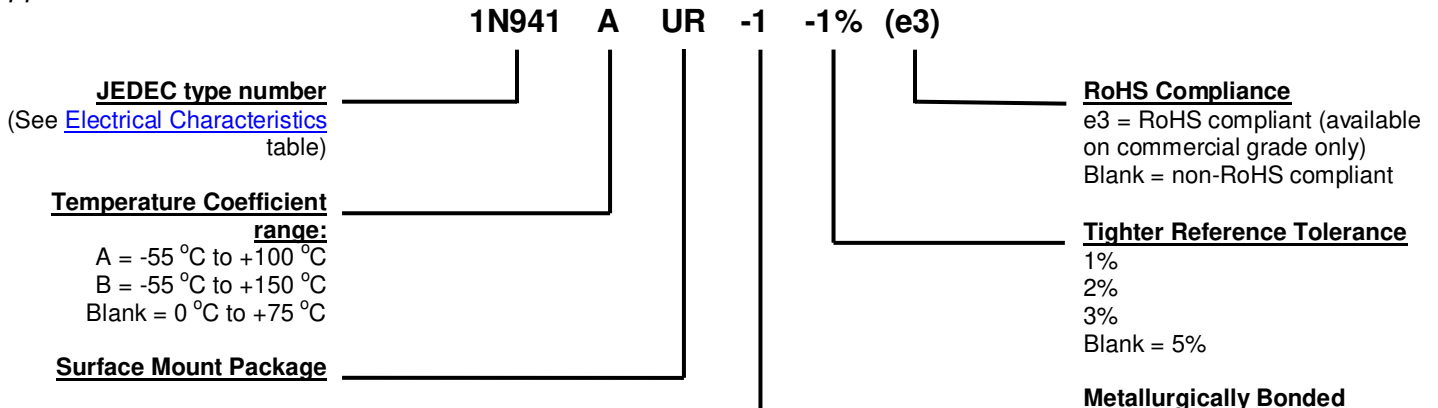
- CASE: Hermetically sealed glass case with surface mount DO-213AA (MELF, SOD-80, LL34) package.
- TERMINALS: Tin-lead plated or RoHS compliant matte-tin plating available (on commercial grade only) and solderable per MIL-STD-750, method 2026.
- MARKING: Cathode band.
- POLARITY: Reference diode to be operated with the banded end positive with respect to the opposite end.
- MOUNTING SURFACE SELECTION: The Axial Coefficient of Expansion (COE) of this device is approximately +6PPM/°C. The COE of the mounting surface system should be selected to provide a suitable match with this device.
- TAPE & REEL option: Standard per EIA-481-B with 12 mm tape. Consult factory for quantities. (Add "TR" suffix to part number.)
- WEIGHT: 0.2 grams.
- See [Package Dimensions](#) on the last page.

**PART NOMENCLATURE**

*Applicable to: JAN, JANTX, JANTXV and JANS level 1N941, 1N943, 1N944, and 1N945 only:*



*Applicable to: Commercial level 1N941 thru 1N945B:*



**SYMBOLS & DEFINITIONS**

Symbol	Definition
$I_R$	Reverse Current: The maximum reverse (leakage) current that will flow at the specified voltage and temperature.
$I_Z, I_{ZT}, I_{ZK}$	Regulator Current: The dc regulator current ( $I_Z$ ), at a specified test point ( $I_{ZT}$ ), near breakdown knee ( $I_{ZK}$ ).
$V_Z$	Zener Voltage: The Zener voltage the device will exhibit at a specified current ( $I_Z$ ) in its breakdown region.
$V_{ZT}$	Zener Voltage Temperature.
$Z_{ZT}$ or $Z_{ZK}$	Dynamic Impedance: The small signal impedance of the diode when biased to operate in its breakdown region at a specified rms current modulation (typically 10% of $I_{ZT}$ or $I_{ZK}$ ) and superimposed on $I_{ZT}$ or $I_{ZK}$ respectively.

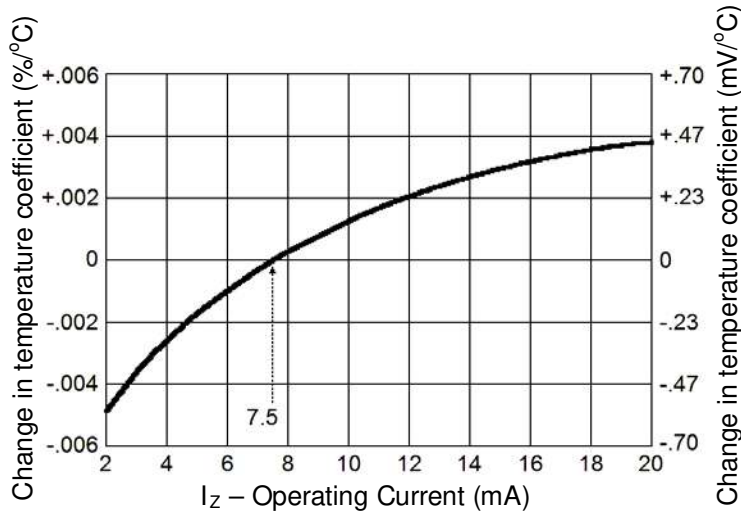
**ELECTRICAL CHARACTERISTICS @ 25°C unless otherwise specified.**

JEDEC TYPE NUMBER (Notes 4)	ZENER VOLTAGE $V_Z @ I_{ZT}$ (Note 3)	ZENER TEST CURRENT $I_{ZT}$	MAXIMUM ZENER IMPEDANCE $Z_{ZT} @ I_{ZT}$ (Note 1)	MAXIMUM REVERSE CURRENT $I_R @ 8 V$	VOLTAGE TEMPERATURE STABILITY $\Delta V_{ZT}$ MAXIMUM (Note 2 & 3)	TEMPERATURE RANGE	EFFECTIVE TEMPERATURE COEFFICIENT $\alpha_{VZ}$
	Volts	mA	Ohms	$\mu A$	mV	°C	% / °C
<b>1N941UR-1</b>	11.12 - 12.28	7.5	30	15	88	0 to +75	0.01
<b>1N941AUR-1</b>	11.12 - 12.28	7.5	30	15	181	-55 to +100	0.01
<b>1N941BUR-1</b>	11.12 - 12.28	7.5	30	15	239	-55 to +150	0.01
<b>1N942UR-1</b>	11.12 - 12.28	7.5	30	15	44	0 to +75	0.005
<b>1N942AUR-1</b>	11.12 - 12.28	7.5	30	15	90	-55 to +100	0.005
<b>1N942BUR-1</b>	11.12 - 12.28	7.5	30	15	120	-55 to +150	0.005
<b>1N943UR-1</b>	11.12 - 12.28	7.5	30	15	18	0 to +75	0.002
<b>1N943AUR-1</b>	11.12 - 12.28	7.5	30	15	36	-55 to +100	0.002
<b>1N943BUR-1</b>	11.12 - 12.28	7.5	30	15	47	-55 to +150	0.002
<b>1N944UR-1</b>	11.12 - 12.28	7.5	30	15	9	0 to +75	0.001
<b>1N944AUR-1</b>	11.12 - 12.28	7.5	30	15	18	-55 to +100	0.001
<b>1N944BUR-1</b>	11.12 - 12.28	7.5	30	15	24	-55 to +150	0.001
<b>1N945UR-1</b>	11.12 - 12.28	7.5	30	15	4	0 to +75	0.0005
<b>1N945AUR-1</b>	11.12 - 12.28	7.5	30	15	9	-55 to +100	0.0005
<b>1N945BUR-1</b>	11.12 - 12.28	7.5	30	15	12	-55 to +150	0.0005

\*JEDEC Registered Data.

**NOTES:**

1. Measured by superimposing 0.75 mA ac rms on 7.5 mA dc @ 25 °C.
2. The maximum allowable change observed over the entire temperature range i.e., the diode voltage will not exceed the specified mV change at any discrete temperature between the established limits.
3. Voltage measurements to be performed 15 seconds after application of dc current.
4. The 1N941BUR-1, 1N943BUR-1, 1N944BUR-1, and 1N945BUR-1 only are military qualified to MIL-PRF-19500/157 up to the JANS level.

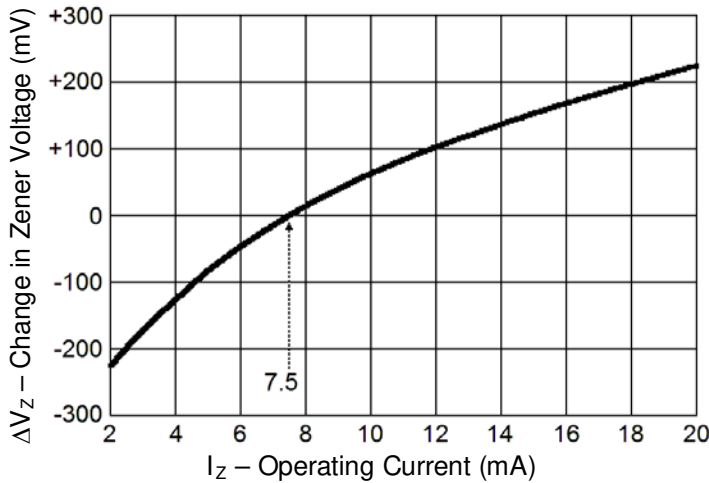
**GRAPHS**

**FIGURE 1**

TYPICAL CHANGE OF TEMPERATURE COEFFICIENT  
WITH CHANGE IN OPERATING CURRENT

The curve shown in Figure 1 is typical of the diode series and greatly simplifies the estimation of the Temperature Coefficient (TC) when the diode is operated at currents other than 7.5 mA.

*EXAMPLE:* A diode in this series is operated at a current of 7.5 mA and has specified Temperature Coefficient (TC) limits of  $\pm 0.002\%/\text{°C}$ . To obtain the typical Temperature Coefficient limits for this same diode operated at a current of 6.0 mA, the new TC limits ( $\%/\text{°C}$ ) can be estimated using the graph in Figure 1.

At a test current of 6.0 mA the change in Temperature Coefficient (TC) is approximately  $-0.0009\%/\text{°C}$ . The algebraic sum of  $\pm 0.002\%/\text{°C}$  and  $-0.0009\%/\text{°C}$  gives the new estimated limits of  $+0.0011\%/\text{°C}$  and  $-0.0029\%/\text{°C}$ .

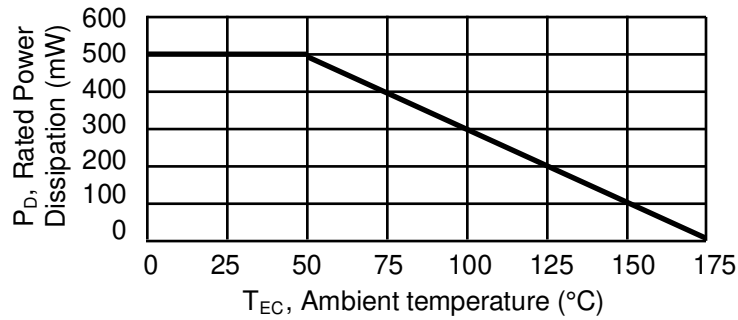

**FIGURE 2**

TYPICAL CHANGE OF ZENER VOLTAGE  
WITH CHANGE IN OPERATING CURRENT

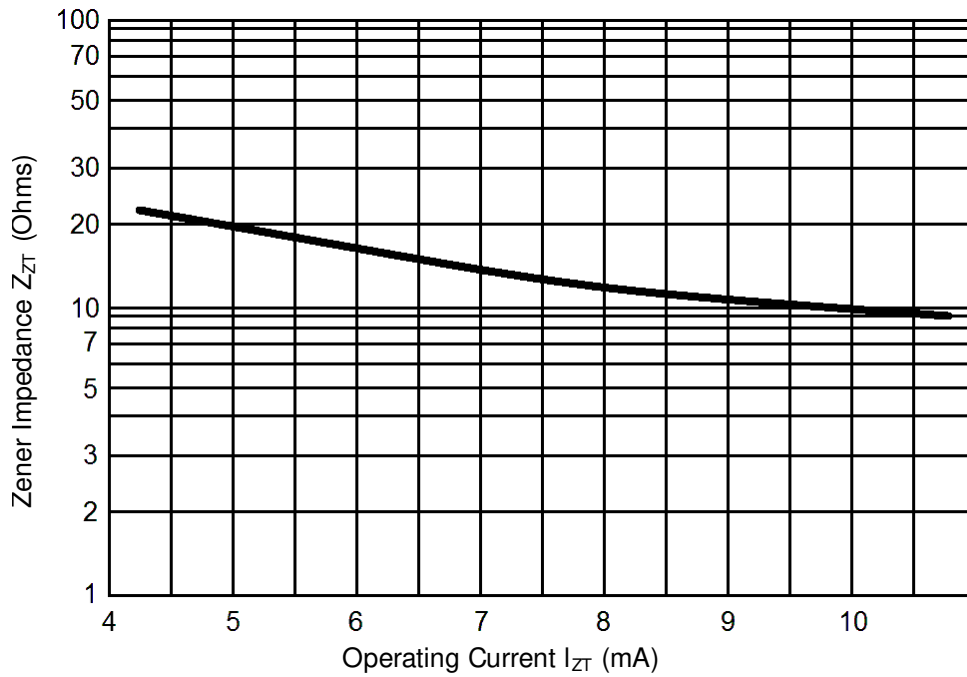
This curve in Figure 2 illustrates the change of diode voltage arising from the effect of impedance. It is in effect, an exploded view of the Zener operating region of the I-V characteristic.

In conjunction with Figure 1, this curve can be used to estimate total voltage regulation under conditions of both varying temperature and current.

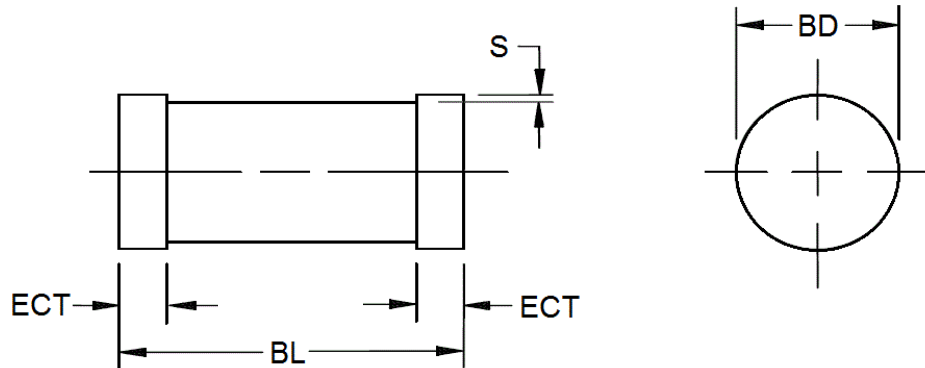
GRAPHS



**FIGURE 3**  
POWER DERATING CURVE

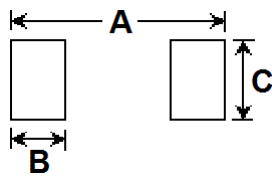


**FIGURE 4**  
TYPICAL ZENER IMPEDANCE VS. OPERATING CURRENT

**PACKAGE DIMENSIONS**

**NOTES:**

1. Dimensions are in inches.
2. Millimeters are given for general information only.
3. In accordance with ASME Y14.5M, diameters are equivalent to  $\Phi$ x symbology.

DIM	Inch		Millimeter	
	MIN	MAX	MIN	MAX
BD	0.063	0.067	1.60	1.70
ECT	0.016	0.022	0.41	0.56
BL	0.130	0.146	3.30	3.70
S	0.001 MIN		0.03 MIN	

**PAD LAYOUT**


DIM	INCH	MILLIMETER
A	.200	5.08
B	.055	1.40
C	.080	2.03