

4G/3G/2G, NB-IoT, Cat-M, GNSS WORLD BAND ANTENNA

**Part Numbers: 2118879-1, 2118879-2,
2118879-4, 2118879-6**

FEATURES & BENEFITS

- RG-316 / RG-174 cable type with straight or right angle SMA connector
- Omnidirectional coverage
- Wide Band coverage for 2G and 3G, 4G, NB-IoT, Cat-M and GNSS coverage
- No matching components required
- Bandwidth and performance are not dependent on ground plane size

SPECIFICATIONS

Frequency Range (MHz)	698-960	1560-2200	2300-2700
VSWR	< 2.5:1	< 2.5:1	< 1.6:1
Average Efficiency	60%	67%	70%
Peak Gain	2.0dBi	3.9dBi	3.9dBi
Average Gain	-2.2dBi	-1.7dBi	-1.5dBi
Power Handling	3 Watt cw		
Feed Point Impedance	50 ohms unbalanced		
Polarization	Linear		
Size	110.0 mm x 14.0 mm x 1.6 mm		
Weight	< 16.1 g		
Mounting	Adhesive type		
Mating Connectors	Right-angle and straight-type SMA, refer to page 5		
Cable (coaxial)	RG-316_2.5mm Dia.RG-174_2.79mm Dia. Refer to page 5		
Operating Temperature	-40 to +85°C		
Storage Temperature	-40 to +85°C		
Packaging Specification	Bag & Box		
Hazardous Materials	A certificate of conformance is available from the product page on TE website.		

RF DATA

VSWR

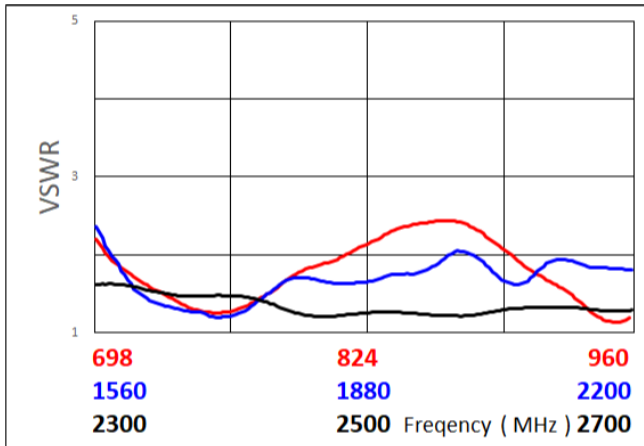

Return Loss

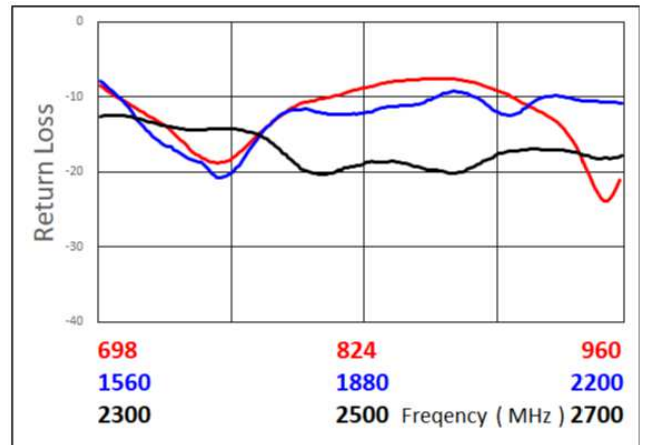

Efficiency

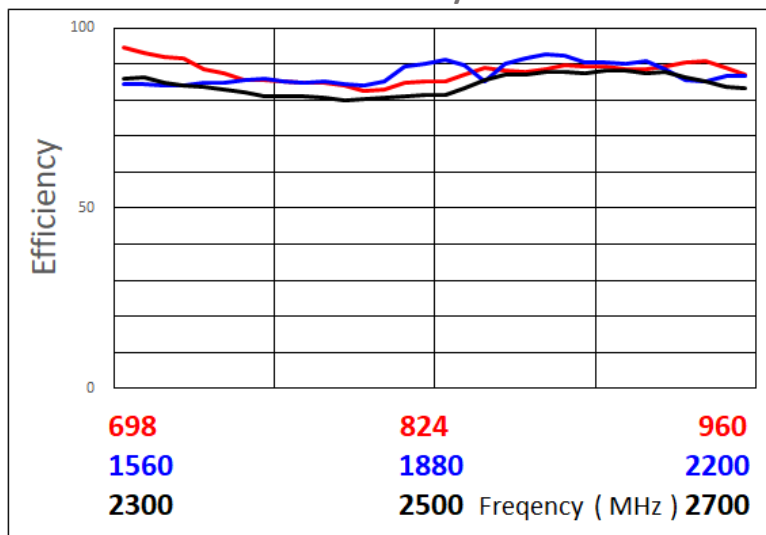

Data measured in free space and on plastic device enclosure

RADIATION PATTERN

Test setup

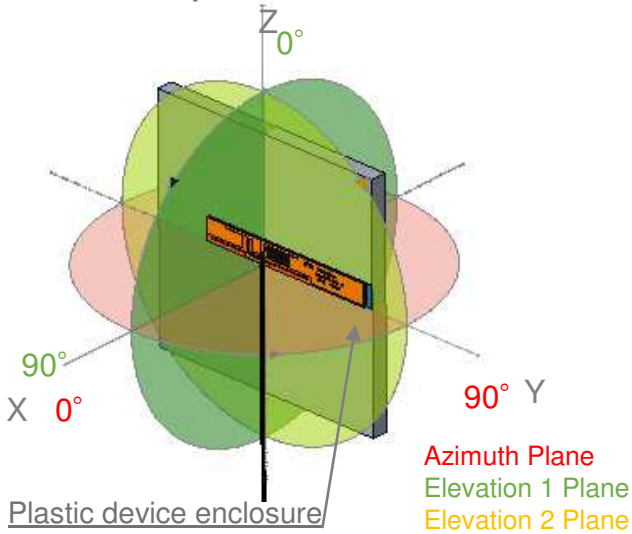

Azimuth

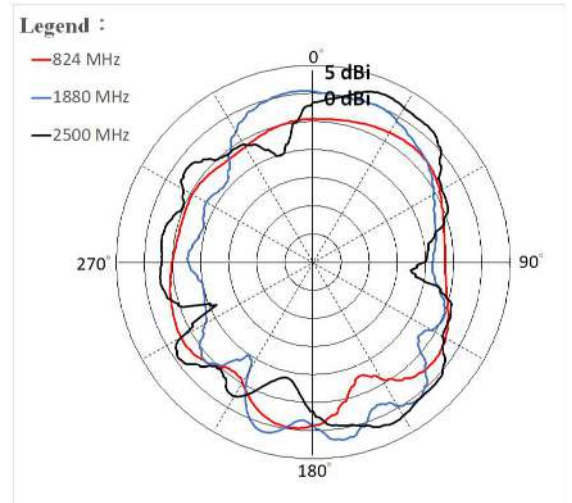

Elevation 1

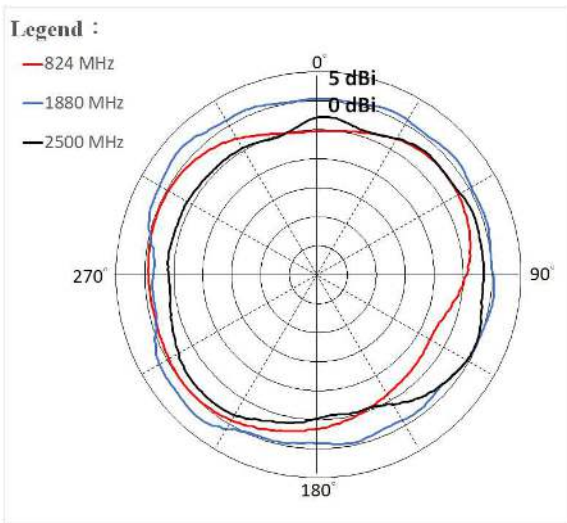

Elevation 2

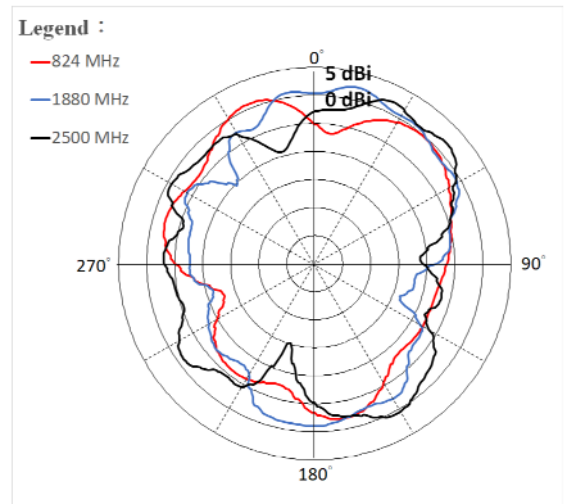

Data measured in free space and on plastic device enclosure

MOUNTING GUIDE AND KEEP OUT AREA

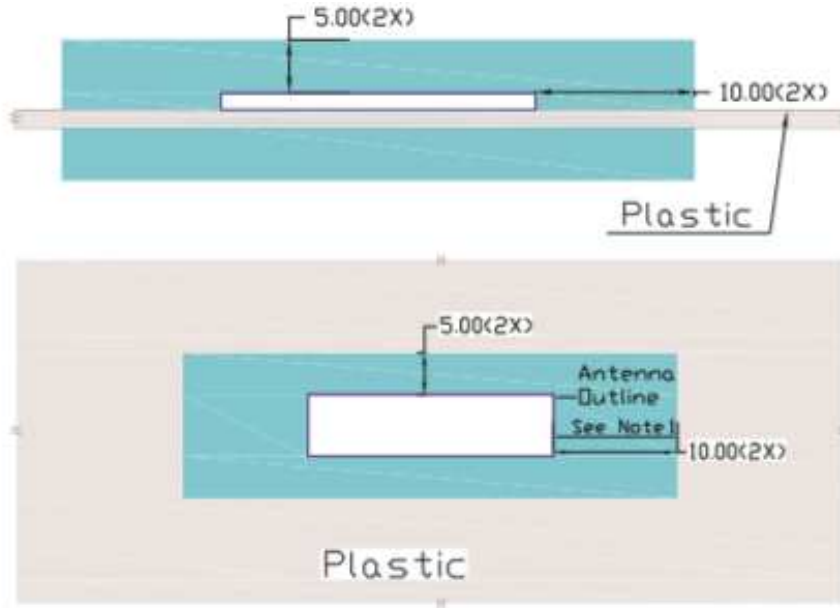

Dimensions: mm
Diagram is not to scale



- NOTES:**
1. Antenna designed to be mounted on plastic cover.
 2. Area in blue indicates Keep Out Area.
 3. For more information please call TE.

Data measured in free space and on plastic device enclosure

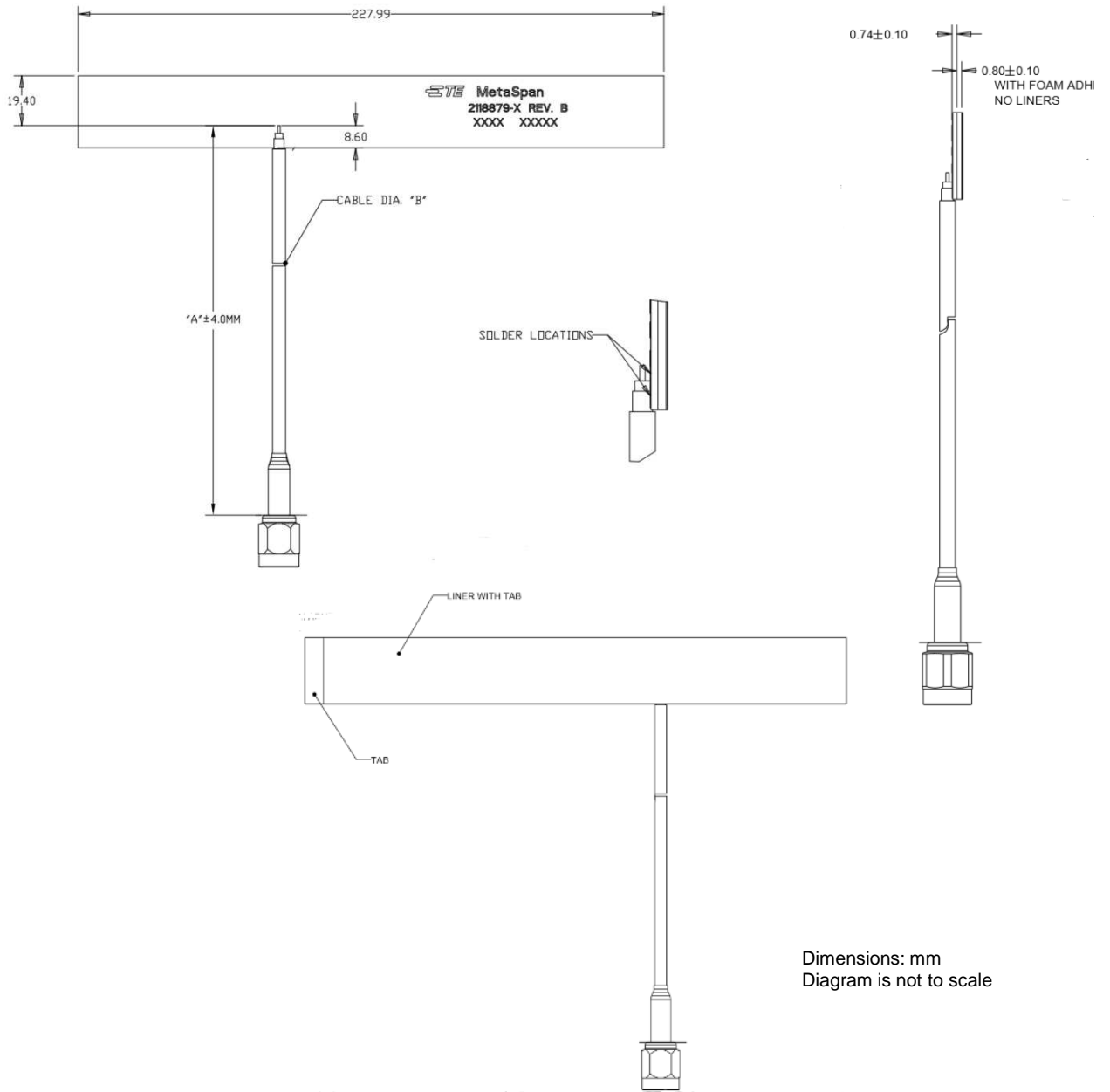
DIMENSIONS



MATING COMPONENTS TO PART NUMBERS AND DIMENSIONS

2118879-1	254	10	RIGHT ANGLE	2.54	RG-316	5-1814400-2	
2118879-2	457.2	18	RIGHT ANGLE	2.54	RG-316	5-1814400-2	
2118879-4	130	5.12	STRAIGHT	2.54	RG-174	5-1814432-2	
2118879-6	457.2	18	STRAIGHT	2.54	RG-174	5-1814432-2	
PART NUMBER	MM	INCH	CONNECTOR TYPE (ON CABLE)	CABLE OD(mm)	CABLE TYPE	PART NUMBER	IMAGE
	CABLE LENGTH					MATING COMPONENTS	

PACKAGING

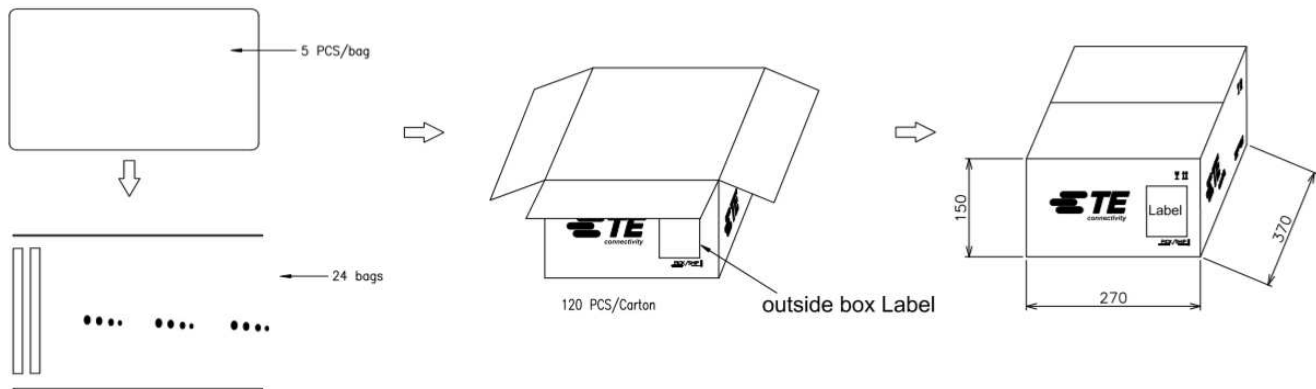

TE TECHNICAL SUPPORT CENTER

USA: +1 (800) 522-6752
 Canada: +1 (905) 475-6222
 Mexico: +52 (0) 55-1106-0800
 Latin/S. America: +54 (0) 11-4733-2200
 Germany: +49 (0) 6251-133-1999
 UK: +44 (0) 800-267666
 France: +33 (0) 1-3420-8686
 Netherlands: +31 (0) 73-6246-999
 China: +86 (0) 400-820-6015

For phone numbers in other countries, go to te.com/support-center

te.com

TE Connectivity, TE Connectivity (logo) are trademarks. All other logos, products and/or company names referred to herein might be trademarks of their respective owners.

The information given herein, including drawings, illustrations and schematics which are intended for illustration purposes only, is believed to be reliable. However, TE Connectivity makes no warranties as to its accuracy or completeness and disclaims any liability in connection with its use. TE Connectivity's obligations shall only be as set forth in TE Connectivity's Standard Terms and Conditions of Sale for this product and in no case will TE Connectivity be liable for any incidental, indirect or consequential damages arising out of the sale, resale, use or misuse of the product. Users of TE Connectivity products should make their own evaluation to determine the suitability of each such product for the specific application.

© 2020 TE Connectivity Ltd. family of companies All Rights Reserved.

01/2022